

# METTLER TOLEDO

## Weight/price scales bPro

### NETWORK

User manual



**METTLER TOLEDO**

## INTRODUCTION

Your new bPro unit is among the finest precision digital computing scales available. It is simple to use and requires minimum maintenance. These scales come from a proud tradition that has made METTLER TOLEDO the worldwide symbol of the highest quality in precision weighing equipment.

Please read these instructions carefully. You will find operating the unit is very simple. In the unlikely event you should experience difficulties, contact your authorized METTLER TOLEDO SERVICE OFFICE listed in the yellow pages of your telephone directory.

Properly used and maintained, your new scale will provide years of accurate weighing which will protect your profits and your customers. Please handle your scale as you would any fine electronic equipment.

## FCC Notice

This device complies with Part 15 of the FCC Rules and the Radio Interference Requirements of the Canadian Department of Communications. Operation is subject to the following conditions: (1) this device may not cause harmful interference, and (2) this device must accept any interference received, including interference that may cause undesired operation.

This equipment has been tested and found to comply with the limits for a Class A digital device, pursuant to Part 15 of FCC Rules. These limits are designed to provide reasonable protection against harmful interference when the equipment is operated in a commercial environment. This equipment generates, uses, and can radiate radio frequency energy and, if not installed and used in accordance with the instruction manual, may cause harmful interference to radio communications. Operation of this equipment in a residential area is likely to cause harmful interference in which case the user will be required to correct the interference at his own expense.

©Mettler-Toledo, Inc. 2000



No part of this manual may be reproduced or transmitted in any form or by any means, electronic or mechanical, including photocopying and recording, for any purpose without the express written permission of Mettler-Toledo, Inc.

U.S. Government Restricted Rights: This documentation is furnished with Restricted Rights.

**METTLER TOLEDO RESERVES THE RIGHT TO MAKE REFINEMENTS OR  
CHANGES WITHOUT NOTICE.**

# PRECAUTIONS

READ this manual BEFORE operating or servicing this equipment.

	 <b>WARNING</b>
	<p>ONLY PERMIT QUALIFIED PERSONNEL TO SERVICE THIS EQUIPMENT. EXERCISE CARE WHEN MAKING CHECKS, TESTS AND ADJUSTMENTS THAT MUST BE MADE WITH POWER ON. FAILING TO OBSERVE THESE PRECAUTIONS CAN RESULT IN BODILY HARM.</p>

FOLLOW these instructions carefully.

	 <b>WARNING</b>
	<p>FOR CONTINUED PROTECTION AGAINST SHOCK HAZARD CONNECT TO PROPERLY GROUNDED OUTLET ONLY. DO NOT REMOVE THE GROUND PRONG.</p>

SAVE this manual for future reference.

	 <b>WARNING</b>
	<p>DISCONNECT ALL POWER TO THIS UNIT BEFORE INSTALLING, SERVICING, CLEANING, OR REMOVING THE FUSE. FAILURE TO DO SO COULD RESULT IN BODILY HARM AND/OR PROPERTY DAMAGE.</p>

DO NOT allow untrained personnel to operate, clean, inspect, maintain, service, or tamper with this equipment.

 <b>CAUTION</b>
<p>BEFORE CONNECTING/DISCONNECTING ANY INTERNAL ELECTRONIC COMPONENTS OR INTERCONNECTING WIRING BETWEEN ELECTRONIC EQUIPMENT ALWAYS REMOVE POWER AND WAIT AT LEAST THIRTY (30) SECONDS BEFORE ANY CONNECTIONS OR DISCONNECTIONS ARE MADE. FAILURE TO OBSERVE THESE PRECAUTIONS COULD RESULT IN DAMAGE TO OR DESTRUCTION OF THE EQUIPMENT OR BODILY HARM.</p>

ALWAYS DISCONNECT this equipment from the power source before cleaning or performing maintenance.

CALL METTLER TOLEDO for parts, information, and service.

 <b>CAUTION</b>
<p>OBSERVE PRECAUTIONS FOR HANDLING ELECTROSTATIC SENSITIVE DEVICES.</p>



















## Contents

Generalities .....	5
Keyboard .....	5
Programming membrane.....	6
Preparatory actions .....	7
Presentation of the "DATA ENTRY" menu.....	7
PLU definition .....	9
Price change .....	10
Define presets.....	11
Tare entry.....	12
Create Barcode .....	13
Vendor key configuration .....	14
Discount key configuration.....	15
Instruction for special offers.....	17
Choose the print paper (ticket or label).....	18
Sales mode.....	19
Mode switching .....	19
Register(with printing on customer ticket) .....	20
Void .....	21
Register(with printing on label).....	21
Tare.....	22
Prepacking.....	23
Select the prepacking mode .....	23
Procedure .....	23
Large sales mode .....	24
Maintenance .....	25
Replacing the thermal paper roll .....	25
Cleaning the print head.....	25
Appendix A: Network configuration .....	26
Appendix B: Error message .....	27
Appendix C: Fonts table .....	30

# Generalities

## Keyboard

### Meaning of the function keys

	Free entry of a price per piece		Continue
	(PRINT,V2,V3,V4) Vendor, clerk		Go back
	Numeric keypad		Tare
	Clear;		Zero
	Customer total, Confirm		Code and switching
	Manual entry of a price per piece to add		Mode and switching
	Manual entry of a price per piece to subtract		Paper feed
	Multiplication		
	(FIX) Fixed unit price / fixed tare		
	Change back		
	Void		

Some type has the [TM] key, used to Tare manually.

### Special functions keys

1 to 70	preset keys
V2,V3,V4	vender keys V2-V4
[-%]	increase/decrease key (Discount key)

Note: The left 70 keys are preset keys which can store 140 PLUs. Different type has different quantity preset keys.















### Remark :

\*V2, V3 and V4 key can be configured as preset keys or vender keys, but one function is available at one time.

\*[-%] key can be configured as preset key or increase/decrease key, but only one function is available at one time.





## Programming membrane

### Meaning of the 'programming' keyboard keys

	Go to beginning of text
	Go to end of text
	move the cursor one position left in the text edit mode
	move the cursor one position right in the text edit mode
	Go to next sub-menu
	Return to previous sub-menu
	Get upper case characters in text edit mode or select a key's 2nd function
	Alternate: special characters in text edit mode
	Backspace (delete the character left of the cursor)
	Delete (delete the character on the cursor)
	Insert (insert a character on the cursor)
	Center the text in text edit mode
	Carriage return (next line)
	Selection of a menu

# Preparatory actions

## Presentation of the "DATA ENTRY" menu

    Call the "DATA ENTRY" menu

### DATA ENTRY

- 01 price change
- 02 create plu
- 03 copy plu
- 06 edit extra text
- 07 list plu
- 08 delete plu
- 09 Define presets
- 10 list presets
- 11 standard preset
- 12 delete preset
- 14 create group
- 15 list group
- 16 delete group
- 26 create sp. offer
- 27 sp. offer backw.
- 28 delete sp. offer
- 29 list sp. offer

30	tare
32	create barcode
35	ticket header
36	ticket bottom
38	running message
39	create operator
40	list operator
41	delete operator
42	shop name
43	advertisement
44	date text
45	date / time
46	discount
47	pack date offset
48	menu end

Select desired menu with   or enter preset code and activate with  key.



# PLU definition

☞ CODE 1 \* Call the "DATA ENTRY" menu

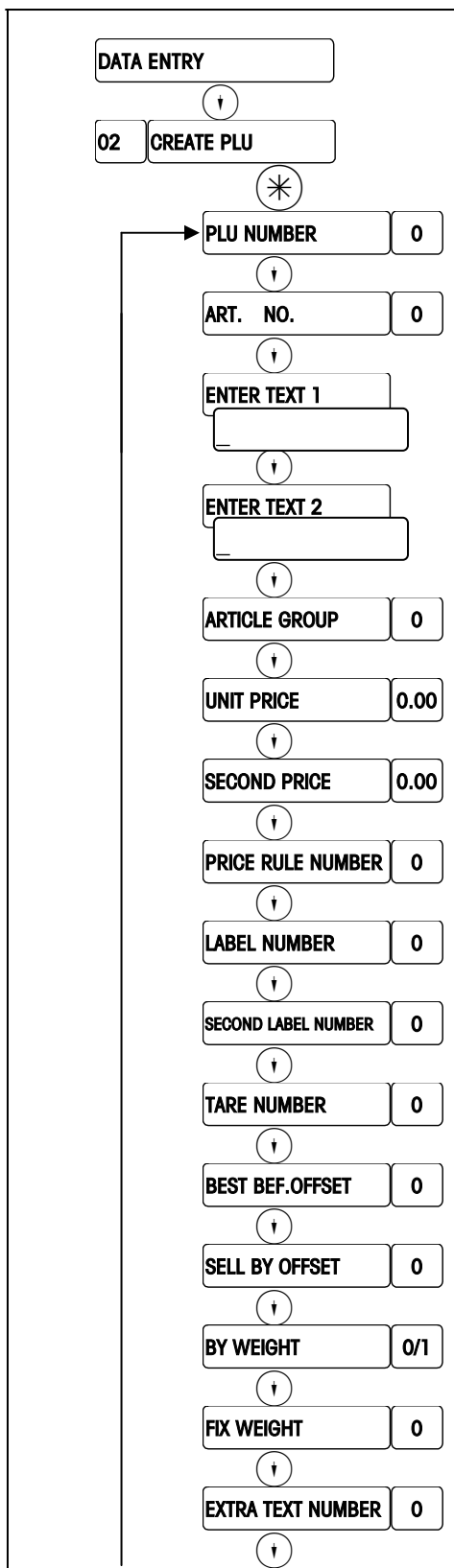

Press the  $\updownarrow$  key twice or enter the preset code 02.

Enter the PLU number.(1~999999)

Enter the article number (up to 13 figures).

Enter the commodity text 1(up to 28 characters)

Enter the commodity text 2(up to 150 characters)  
(Should first set the quantity of characters in CODE 5)

Enter the article group number.(1~99)

Enter the unit price.(0~9999.99)

Enter the second unit price.(0~9999.99)

Select the price using first price or second price.

Input the label number (0-108, 101~108 are fixed label formats)  
Input second label number

Input preset tare number.(1-16)

Input the best before offset.(0-999 days)

Input the sell by offset.(0-999 days)

Is it an article per piece or a weighed article ?  
0 = weighed article, 1 = article per piece  
Input the FIX WEIGHT for article per piece

Input the Extra Text number.

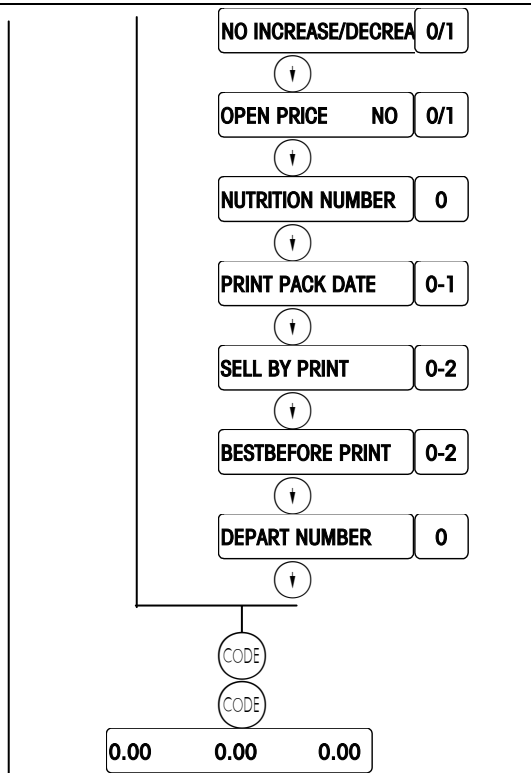

0=no increase/decrease 1=enable increase/decrease

0=price can't be changed

1=price can be changed by # key

Input the nutrition number.

Select if print pack date, 0=print, 1=not print

Select if print sell by date, 0=not print, 1=print date, 2=print days

Select if print best before date, 0=not print, 1=print date, 2=print days

Input department number.

Press  $\downarrow$  to enter or change other PLU.

Press the CODE key twice to return to the weighing mode.

Note: Each option can be selected or hidden via "code 6"-16.

## Price change

$\downarrow$  CODE 1 \* Call the "DATA ENTRY" menu

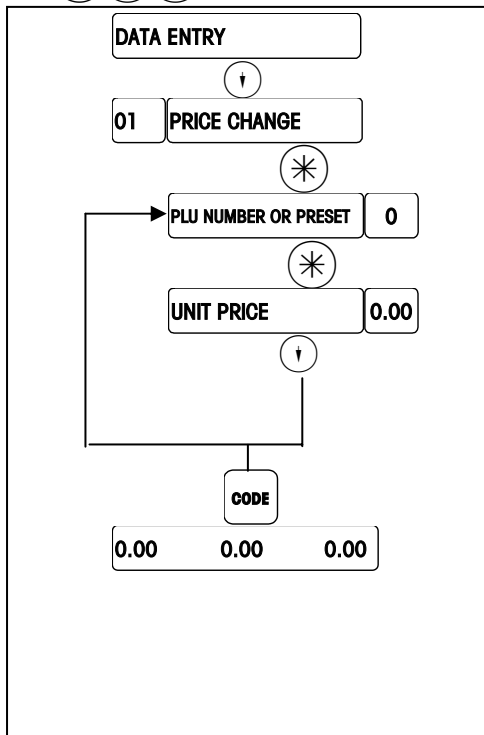

Press the  $\downarrow$  key twice or enter the preset code 01.

Enter price change

Enter PLU number. (up to 6 digits)

Enter the unit price.

Press  $\downarrow$  for other price changes.



Press CODE to return to weighing mode.

# Define presets

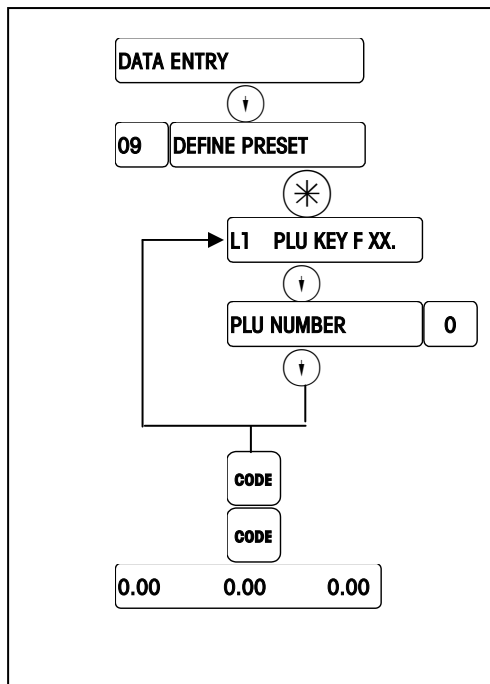
 Call the menu "DATA ENTRY"



Enter preset code 09.

\*Press the desired PLU preset key  
 (Shift L1 and L2 by the key )  
 Enter PLU number. (up to 6 digits)  
 Press  to enter or modify another PLU preset.

Press  2 times to return to weighing mode.

**Remark :**

\*The Type bPro can store 140 preset keys which are divided into two levels L1 and L2.  
 L1 can store P1~P70 and L2 can store P71~P140.  
 Shift L1 and L2 by the key .

(some type the preset key quantity is different)

# Tare entry

☞ **CODE** 1 \* Call the "DATA ENTRY" menu

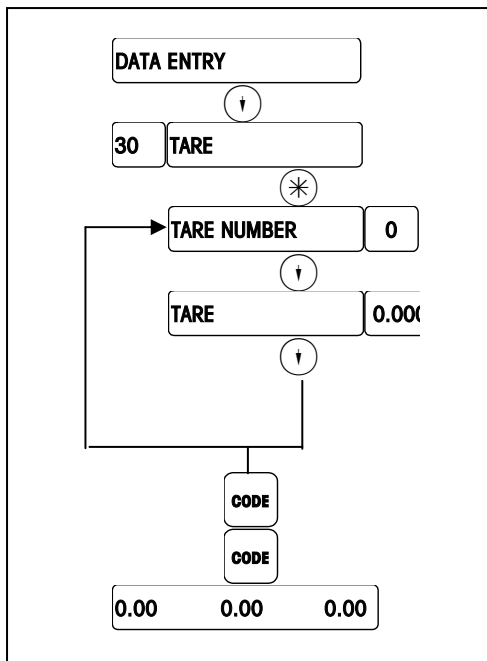

Enter the preset code 30

Enter the tare number (1-16).

Enter the tare weight in grams \*) or put the empty recipient on the scale, then validate with the tare key (T).

Press (↓) to affect the next tare memory.

Press the (CODE) key twice to return to the weighing mode.

\*) Respect the increment (1 g, 2 g or 5 g, depending on the weighing range)

# Create Barcode

Call the "DATA ENTRY" menu

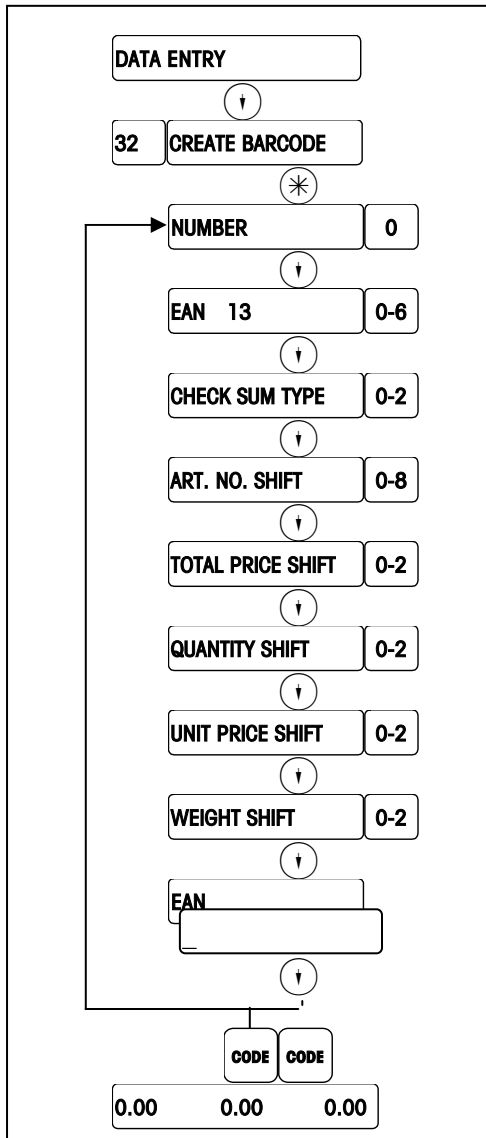

Enter the preset code 32

Enter the EAN number (1-8).

Select barcode type

0=EAN8, 1=EAN 13, 2=ITF 25 Narrow, 3=ITF 25 Wide, 4=EAN 128, 5=EAN 13+5, 6=UPC-A

Select CHECK SUM type, 0=Normal, 1=Reverse, 2=No check sum

Select shift digit for the Article number in barcode

Select shift digit for the total price in barcode

Select shift digit for the quantity in barcode

Select shift digit for the unit price in barcode

Select shift digit for the weight in barcode

Enter the EAN CODE such as

22AAAAAABBBBBB etc.

Press to affect the next EAN code memory.

Press the key twice to return to the weighing mode.

### Legend of Barcode Identifications

A = Item number	4 - 12 figures
B = Total Price	4/5/6 figures
C = Check digit	1 figures
D = Date	2/4/6 figures
N = Ticket number	4 figures
P = PLU code	4/5/6 figures
Q = Weight/Quantity	4/5 figures
W = Group number	2 figures
0-9 Figures	1 - 12 figures

### Examples:

- 0AAAAAAAAA (UPC, Ten digit Item Number)
- 2AAAAACBBBB (UPC, 5-D Item/Price Check Digit/4-D Price)
- 2AAAAOBBBB (UPC, 5-D Item/Zero Fixed/4-D Price)
- 2AAAABBBBB (UPC, 5-D Item/No Price Check/5-D Price)
- 2AAAAACQQQQ (UPC, 5-D Item/Wgt Check Digit/4-D Wgt)
- 2AAAAAQQQQ (UPC, 6-D Item/No Price Check/4-D Wgt)
- 2AAAAQQQQQ (UPC, 5-D Item/No Price Check/5-D Wgt)
- 21AAAABBBBB (EAN, 5-D Item/5-D Price)
- 21AAAABBBBB (EAN, 4-D Item/6-D Price)
- 21AAAAACBBBB (EAN, 5-D Item/Price Check Digit/4-D Price)
- 21AAAACBBBB (EAN, 4-D Item/Price Check Digit/5-D Price)
- 21AAAAQQQQQ (EAN, 5-D Item/5-D Wgt)
- 21AAAACQQQQ (EAN, 4-D Item/Wgt Check Digit/5-D Wgt)

**\*NOTE:** The default label format use the NO.2 barcode format. The free label format you can select the barcode number in label editing software.

# Vendor key configuration

- Vendor name edit

☞ CODE 1 \* Call the "DATA ENTRY" menu

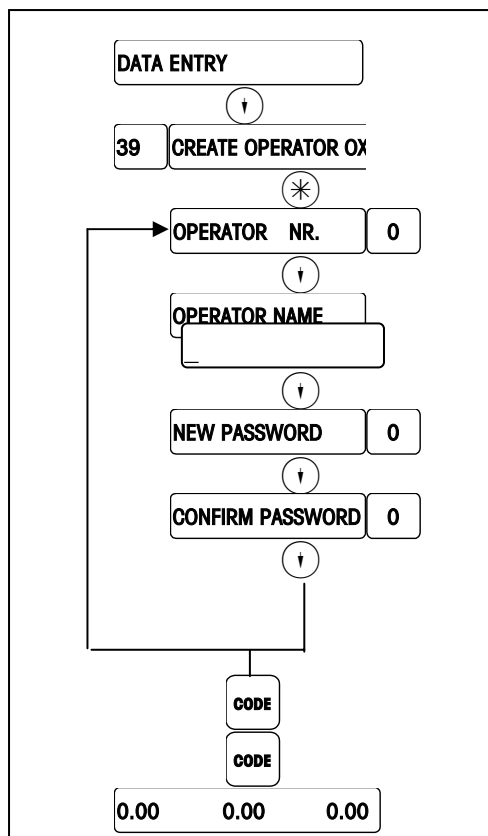

Enter preset code 47.

Enter the number of the desired vendor.

Enter the name of the vendor.

If necessary input the password of the vendor

Confirm the password

Press ↓ to enter or modify another vendor's number.

Press the CODE key twice to return to the weighing mode.

- Vendor preset key permission

☞ CODE 3 \* Call the "KEYBOARD CONFIGURATION" menu

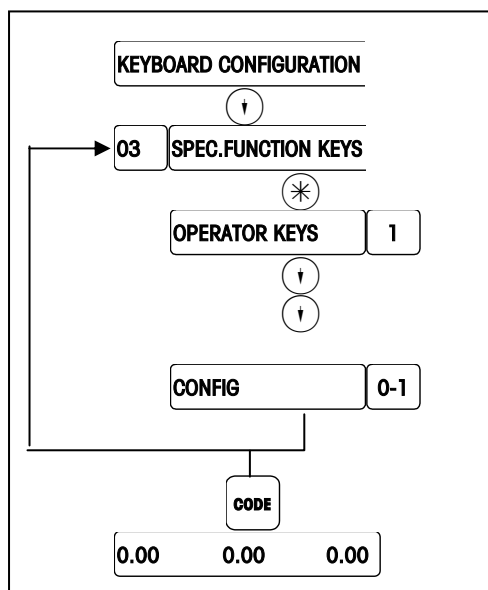

Enter preset code 03.

Enter number of operator keys.(1~4)

0=Don't storage the configuration.

1=Storage the configuration.

Press the CODE key to return to the weighing mode.

• Log in and log out an operator

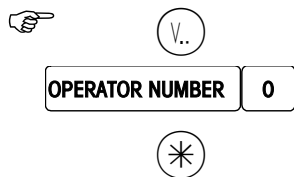

Press vendor key about 10 sec until display 'operator number'  
Then input operator number.  
Then confirm with ENTER key.

## Discount key configuration

• Discount rate edit

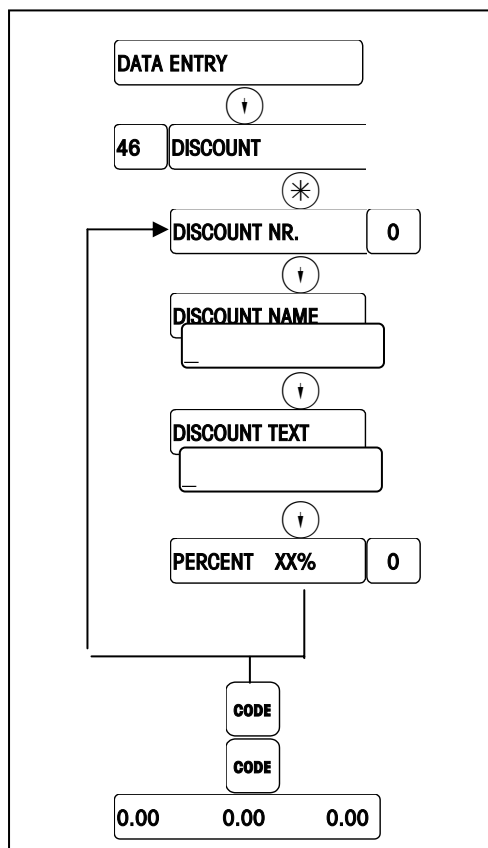
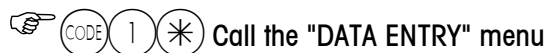

Enter preset code 60.

Enter increase/decrease number(1~9).

Enter increase/decrease name.

Enter increase/decrease text.

Enter increase/decrease rate.

Press the **CODE** key twice to return to the weighing mode.

• **Discount permission**

☞ **CODE** 6 \* Call the "SPECIAL FUNCTION" menu

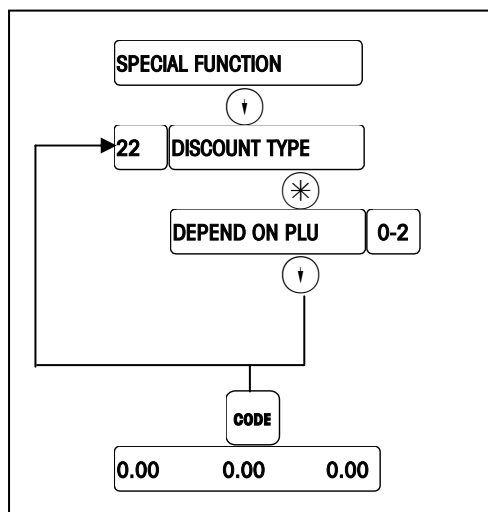

Enter preset code 01.

0=depend on PLU  
 1=all PLU enable, 2=all PLU disable

Press the **CODE** key to return to the weighing mode.

• **Log in increase/decrease key**

☞ **CODE** 3 \* Call the "KEYBOARD CONFIGURATION" menu

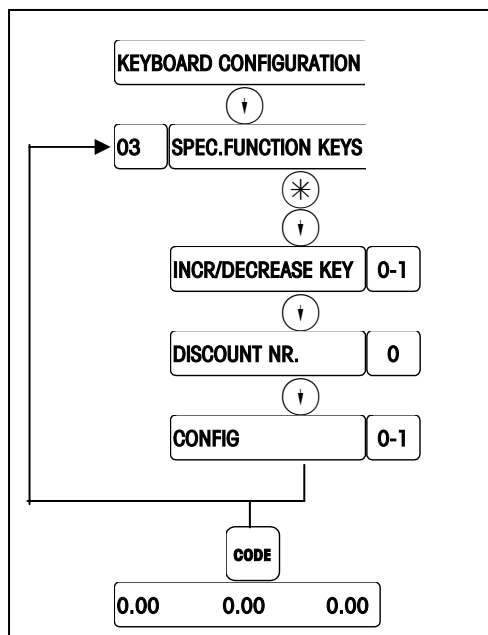

Enter preset code 03.

0=Disable increase/refund  
 1=enable increase/refund

Enter increase/refund number  
 0=Don't storage the configuration  
 1=storage the configuration

Press the **CODE** key to return to the weighing mode.



# Instruction for special offers

- Define a special offer

Call the "DATA ENTRY" menu

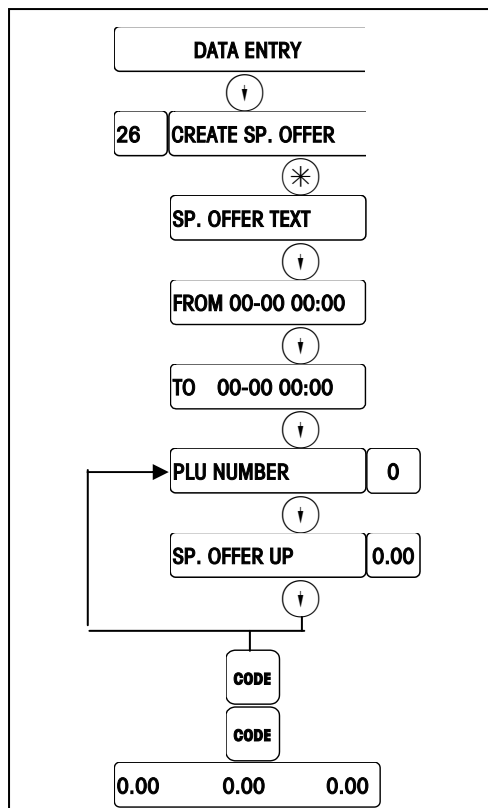

Enter preset code 26.

Enter the special offer text.

Enter the date the special offer starts.

Enter the date the special offer ends.

Enter the PLU number.

Enter the special offer of the article.  
Press the key to create special offer price of another PLU.

Press the key twice to return to the weighing mode.

- Cancel a special offer

Call the "DATA ENTRY" menu

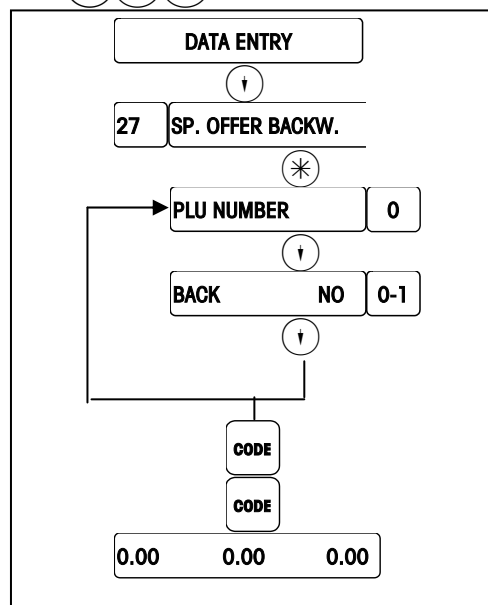





Enter preset code 27.

Enter the PLU number.

0=No prohibition  
1=Prohibit SP. OFFER for this PLU  
Press the key to prohibit special offer price of another PLU.  
Press the key twice to return to the weighing mode.

# Choose the print paper(ticket or label)

    Call the "OPERATOR CONFIG" menu

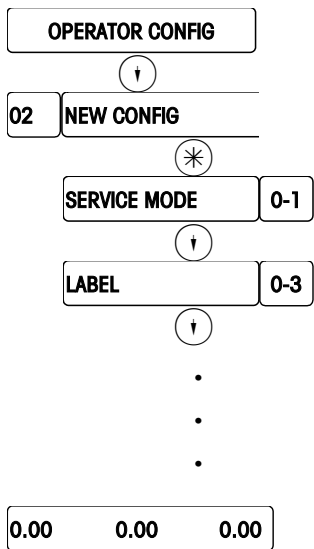

Enter preset code 01 .

Select the status of service mode or prepack mode when open the scale

0=service mode; 1=prepack mode

0=cust. ticket; 1=label; 2=label+total label, 3=total label



Press the  key until return to the weighing mode.

# Sales mode

## Mode switching

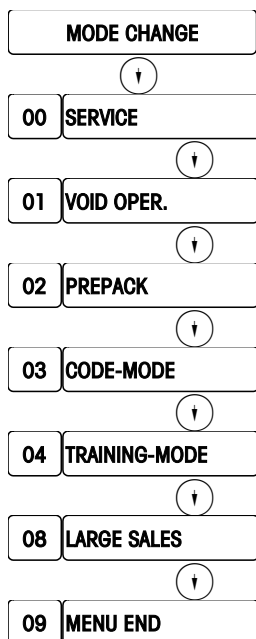
 **MODE** Call the menu "Mode switching"



With   select the desired sub-menu, or enter the preset code.

Select/return to service mode.

Select/return to void operation mode.

Select/return to prepack mode.

Select/return to code mode.

Select/return to training mode.

Select/return to large sales mode.

Press  to continue or  to return to weighing mode.

With   or the preset code, select the corresponding menu item, then activate it with the  key.

### Service mode

-For all weighing functions, registering, data entry and sales reporting

### Code mode

-Enter the code functions

### Training mode

-Learning and practical exercises on the device, without the realized turnover being memorized.

-The display reads "TRAINING"

### Void oper. mode

-VOID OPERATION AFTER CHECK OUT means the ticket or label has been printout, and these transactions will be deleted from the statistics data.

### Prepack mode

-For packing fieldwork of the supermarket. In this application, only print label, the small variety but large quantity print-work.

### Large sales mode

-When the article is too big to weigh, operator can enter this mode by inputting the article weight and count price.

# Register (with printing on customer ticket)

## 1. Weighed PLU/ PLU per piece / overwriting of a defined price per piece

- Put the article on the scale.
- Press a direct PLU preset key or enter the PLU code.  
(Overwriting of a defined price per piece :  
The defined price per piece can eventually be overwritten by the current article, by pressing (#)).  
or press (#) key first to enter a weighed price.for an article per piece, first press (+) or (-) to entry the temporary price.
- Register the transaction with your personal (V..) key.
- Register the next article.
- Conclude the sale and print off the customer ticket by pressing the (\*) key, followed by your personal (V..) key.

## 2. Subtotal

Displaying the subtotals of all the vendors



Displaying the subtotal of vendor x



By repeatedly pressing the (↓) key, check the subtotal of every vendor.

## 3. Calculating the change

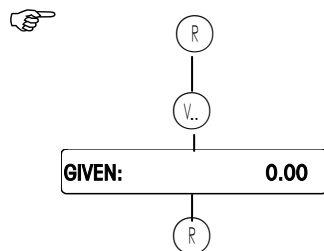

To use the "Calculating the change function", you only have to conclude the sale by the following sequence of keystrokes, the key [R] replaces the key (\*).  
Enter the amount received by the client.

The cashregister opens automatically.

## Void

### a) The last operation



### b) one of the previous operations



**Remarks :** With you have an overview of the different transactions printed on the ticket.

### c) total operations



## Register (with printing on label)

### Weighted PLU/ PLU per piece / overwriting of a defined price per piece

- Put the article on the scale.
- Press a direct PLU preset key or enter the PLU code.  
(Overwriting of a defined price per piece :  
The defined price per piece can eventually be overwritten by the current article, by pressing ).  
or press key first to enter a weighed price. for an article per piece, first press or to entry the temporary price.
- With your personal key , start printing the label.

**Tare****a) Compensation of a weighed tare (tare an empty recipient)**

- Place the empty recipient.
- Press the  key.
- Put the full recipient and register the transaction.
- The tare weight is cleared from the moment the transaction is registered and the scale is cleared.



**b) Tare manually**

Press the TM key and input the tare value manually and confirm with  key.

**c) Plu specific tare weight**



the tare is linked with plu, recall the plu to recall it.

**d) Fixed tare compensation**

- Put tare weight on the scale.
- Press the  key.
- Press the  key.

**e) Recall an operator specific tare weight**

The tare has to be logged in before recall. The way to log in is as follows:

- Place the empty recipient.
- Press the  key.
- Press the  key.

# Prepacking

## Select the prepacking mode

  Call the menu "Mode switching"

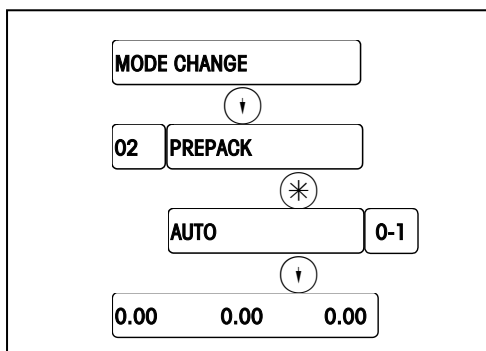

Enter preset code 02.

Select/return to prepack mode

Select the print triggering mode:

0=print after stabilizing; 1=print by pressing the vendor key.

## Procedure

- Select the PLU
- Place the article
- Using the vendor key, start label printing (if "manu" is chosen) or start label printing by varying the load (if "auto" is chosen).
- Remove the label
- Weight the next article

### Print a batch of prepack labels for the article by Count PLU

This function can be in prepack mode only, it is in effect under auto-print status. And only for the articles by Count PLU.

 ENTER ONE PLU NUMBER

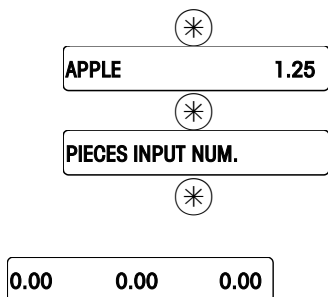

Before you call a plu, you must empty the platter of scale.

Active batch print function

Display the price of the PLU, you can enter number follow X key for more than one.

Enter print quantity (max. 999 pcs)

After the previous label is taken away, then print the next label.

**NOTE:** Press the key  twice can quickly switch prepack mode and service mode.

## Large sales mode

 **MODE** Call the menu "Mode switching"

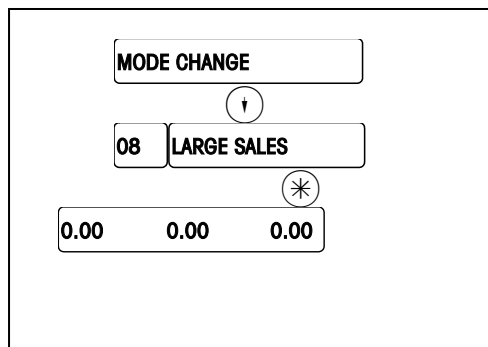

Enter preset code 08.

enter large sales mode

After entering large sales mode, operator shall first input the called PLU ,if the parameter of "price shall be entered via key (#) has been configured ". Then press the key (#) , enter large sales weight and register this transaction. If the price is required to input temporarily, operator shall first press the key (#), then enter the temporal price , again press the key (#) , input large sales weight and register this transaction at last.



# Maintenance

## Replacing the thermal paper roll

- Open the door of printer housing on the right side of the scale, pull out printer.
- Remove the empty reel.
- Press down the green lever.  
The print head flips out of his housing.
- Insert the new thermal paper roll in accordance with the drawing.
- Pull out the paper untill correct tension is reached.
- Push back the print head until it clicks.
- Tear off the paper that sticks out.
- Close the weighing plate.

## Cleaning the print head

- Switch off the scale.
- open the door of printer holder on the right side of the scale.
- pull out the printer.
- Press down the green lever.  
The print head flips out of his housing.
- Take off the cap from the cleaning pen.
- Clean the print head with the moist tip of the pen.
- Push back the print head until it clicks.
- Put on the cap of the cleaning pen.
- Pull back the printer,close the door.
- Switch on the scale.



Use only the cleaning pen,for cleaning the print head.  
The cleaning pen be enclosed with the scale.  
Other cleaning materials will destroy the print head.

# Appendix A: Network Configuration

Call the menu "Technical service "

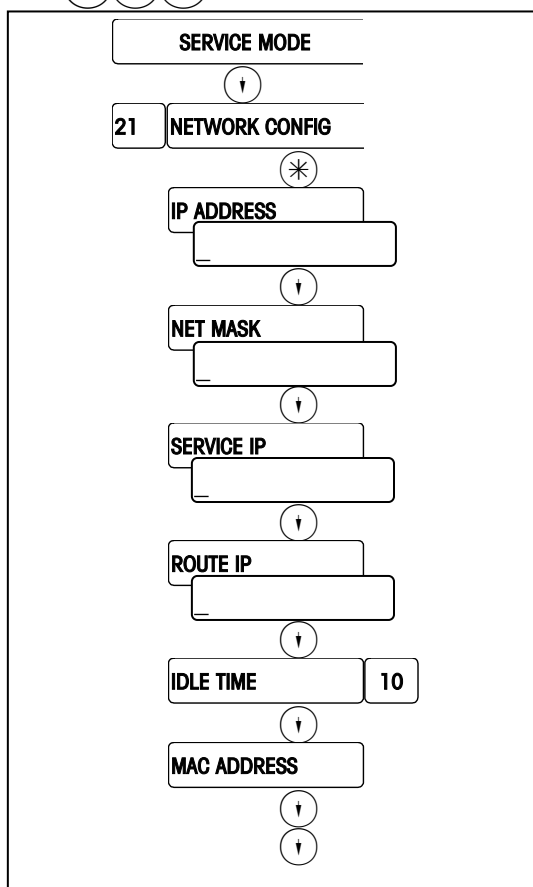

Enter the preset code 21.

Enter network configure

Input IP address

Input NET MASK address

Input SERVER IP address (If necessary)

Input ROUTE IP address (If necessary)

Input IDLE TIME (10 is ok)

Scale will restart automatically.

After completing setup, if necessary you can choose the PLU SOURCE. The operation as bellow:

Call the menu "Technical service "

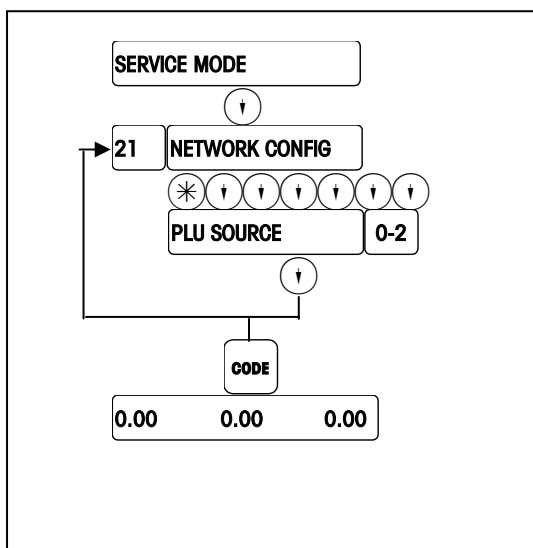

Enter the preset code 21.

0=Get PLU from local scale

1=Get PLU from NETWORK

2=First from network, then from local scale

Press to exit .

## Appendix B: Error Message

- **Warning Message**

**INPUT TOO BIG**---The input is too big.

**INPUT TOO SMALL**---The input is too small.

**TOO MUCH INPUT**---The input is out of limit.

**WRONG CODENR.**---The code number is invalid.

**KEY NO FUNCTION**---The key has no function.

**KEY BLOCKED**---The key is disabled. Check the KEYBOARD CONFIGURE.

**PLU NOT FOUND**---The entered PLU number does not exist.

**AG NOT FOUND**---The entered Group number does not exist.

**OPER.NOT FOUND**---The entered Operator number does not exist.

**LABEL NOT FOUND**---The entered Label Format does not exist.

**PLUNR IS OCCUP**---You are trying to duplicate a PLU into an exist PLU number.

**LABELNR. OCCUP**---You are trying to duplicate a label format into an exist label format number.

**DISCOUNT IMPOSS**---This PLU does not allow to be discounted. Check the PLU Discount configuration, or this PLU is in special offer.

**NO FURTHER REG.**---No further transaction has been recorded.

**NO STABLE WEIGHT**---The weight is not stable.

**AG NOT DELETABLE**---This Group contains total data and can not be deleted.

**OP NOT DELETABLE**---This Operator contains total data and can not be deleted.

**MEMORY FULL**---Memory is full.

**WEIGH AGAIN**---You are trying to record one item twice. Remove the item from the platter and put a new item on the platter.

**WRONG LABEL**---The installed label roll does not match the configured label format.

**LABEL MOVED**---The stepper motor or the rewind motor is not working properly.

**CHANGE PAPERROLL**---The label roll is not installed or the label roll is empty.

**TAKE LABEL OFF**---Take off the current label before printing the next one.

**NO FREE OX KEY**---All the configured operator keys have been occupied.

**PRINT TICKET**---Print out the customer ticket before logging out.

**OPEN CUST. TICK**---You are trying to delete an operator who has total data.

**OX NOT LOGGED-IN**---The operator has not be assigned to an operator.

**PAYMENT TOO LOW**---The payment is less than the total amount.

**TARE TOO BIG**---The entered tare is too big.

**PLU TARE ACTIVE**---You are forbidden to override the PLU tare.

**PUT PLATTER ON** ---The weight is too small and out of power up zero range.

**ZERO NOT CAPTURE** ---The weight is too big and out of power up zero range.

**WEIGHT TOO SMALL**---The weight is too small to be printed.

**ERROR TAKE-SENS**---The take label sensor is not working properly.

**ERROR POS\_SENS**---The gap sensor is not working properly.

**ERROR INTERFACE**---The serial port is not working properly.

- **Error Message**

Listed below are the possible error codes are listed. When an error code appears, the scale should be switched off and on. In many cases the error will disappear.

There are 3 different kinds of error messages:

**Error Status 1:**

Warning! After the warning the scale can still be used.

**Error Status 2:**

Press "CODE" key. Change to one of the CODE menu. Back to normal operation mode.

**Error Status 3:**

Press "CODE" key and enter SERVICE MODE, after returning to normal operation mode the scale will perform RESET.

Error Message	Reason	Status	Action
ERROR 300 PRINTER	Printer driver defect	2	Replace Main Logic PCB
ERROR 301 PRINTER	Printer driver defect	2	1 Reflash the software 2 Replace Main Logic PCB
ERROR 307 PRINTER	Printhead defect	2	1 Replace printhead 2 Replace printhead harness 3 Replace Main Logic PCB
ERROR 308 PRINTER	Printer driver defect	1	Replace Main Logic PCB
ERROR 310 PRINTER	Printer driver defect	2	Replace Main Logic PCB
ERROR 101 AP	Real Time Clock defect	1	Replace Main Logic PCB
ERROR 400 CELL	Load Cell defect	-	1 Replace Main Logic PCB 2 Replace Load Cell
ERROR 401 CELL	Load Cell defect	-	1 Recalibrate 2 Replace Main Logic PCB 3 Replace Load Cell
ERROR 200 DATABASE	Data bank error	3	Reset RAM
ERROR 201 XX DATABASE	XX Data error	2	1 Reset RAM 2 Delete Data XX
ERROR 202 XX DATABASE	XX Data error	2	1 Reset RAM 2 Delete Data XX
ERROR 203 YY DATABASE	YY Data error	2	1 Reset RAM 2 Configure YY
ERROR 205 DATABASE	Data bank error	3	Reset RAM

### Meaning of XX

01 Operator	07 Group data
02 Ticket data	13 Label data
03 Time total data	15 Date text data
04 Text data	21 PLU label data
05 Barcode data	23 Store adress
06 Tare data	24 PLU data

### Meaning of YY

01 Operator Configure	04 Password Configure
03 Keyboard Configure	

## Appendix C: Fonts Table

Font No.	Font Type	Heigh in mm	Characters per line
1	AaBbCcLlDdEeFfGgHhIiJjKkLlMmNnOoPp	1.9	36
2	AaBbCcDdEeFfGgHhIiJjKkLlMmNnOoPp	2.4	36
3	AaBbCcDdEeFfGgHhIiJjKkLlMmNnOoPp>	2.9	36
4	AaBbCcDdEeFfGgHhIiJjKkLlMmNnOoPp	3.7	36
5	AaBbCcCcEeFfGgHhIiJjKkLlMmNnOoPp	4.8	36
6	AaBbCcDdEeFfGgHhIiJjKkLl	3.2	27
7	AaBbCcDdEeFfGgHhIiJjKkLl	6.4	27
8	AaBbCcDdEeFfGgHh	2.4	18
9	AaBbCcDdEeFfGgHh	2.9	18
10	AaBbCcDdEeFfGgHh	3.7	18
11	AaBbCcDdEeFfGgHh	4.8	18
12	AaBbCcDdEeFfGgHh	4.8	18
13	AaBbCcDdEeFfGgHh	9.6	18
14	AaBbCcDdEeFf	3.2	13
15	AaBbCcDdEeFf	6.4	13
16	AaBbCcDdEe	2.9	11
17	AaBbCcDdEe	3.7	11
18	AaBbCcDdEe	4.8	11
19	AaBbCcDd	4.8	9
20	AaBbCcDd	9.6	9

In conformance with the European Directive 2002/96/ EC on Waste Electrical and Electronic Equipment (WEEE) this device may not be disposed of in domestic waste.

This also applies to countries outside the EU, per their specific requirements.

Please dispose of this product in accordance with local regulations at the collecting point specified for electrical and electronic equipment.



If you have any questions, please contact the responsible authority or the distributor from which you purchased this device.

Should this device be passed on to other parties (for private or professional use), the content of this regulation must also be related.

Thank you for your contribution to environmental protection.

# **METTLER TOLEDO**

## **Scales & Systems**

P/N 72186163

(4/06).01

METTLER TOLEDO®

is registered trademarks of Mettler-Toledo, Inc.

©2000 Mettler-Toledo, Inc.

