



Direct-LinkTM Industrial Ethernet Unmanaged Switches and Fiber Converter

Hardware Reference Guide

Document Edition: 1.0

Document #: 715-0089

Document Edition: 1.0

Date: November 22, 2006

This document applies to the following Ethernet switch products: DRL-111, DRL-241, DRL-250, DRL-280, DRL-281 and DRL-290.

Copyright ©2006 Woodhead Software & Electronics, Division of Woodhead Canada Limited

This document and its contents are the proprietary and confidential property of Woodhead Industries Inc. and/or its subsidiaries and may not be used or disclosed to others without the express prior written consent of Woodhead Industries Inc. and/or its subsidiaries.

SST and Direct-Link are trademarks of Woodhead Industries. All other trade names are trademarks or registered trademarks of their respective companies.

At Woodhead, we strive to ensure accuracy in our documentation. However, due to rapidly evolving products, software or hardware changes occasionally may not be reflected in our documents. If you notice any inaccuracies, please contact us (see Appendix C of this document).

Written and designed at Woodhead Software & Electronics, 50 Northland Road, Waterloo, Ontario, Canada N2V 1N3.

Hardcopies are not controlled.

Preface

Preface Sections:

- Purpose of this Guide
- Conventions

Purpose of this Guide

This manual explains how to install and maintain the Direct-Link Industrial Ethernet Switches and Fiber Converter.

Conventions

This guide uses special notation to help enhance your understanding.

Special Notation

The following special notations are used throughout this guide:



Warning

Warning messages alert the reader to situations where personal injury may result. Warnings are accompanied by the symbol shown, and precede the topic to which they refer.



Caution

Caution messages alert the reader to situations where equipment damage may result. Cautions are accompanied by the symbol shown, and precede the topic to which they refer.



Note

A note provides additional information, emphasizes a point, or gives a tip for easier operation. Notes are accompanied by the symbol shown, and follow the text to which they refer.

Contents

Preface	iii
Purpose of this Guide	iv
Conventions	iv
Special Notation	iv
General Information	7
1.1 Overview	8
1.2 Part Numbering Convention	8
1.3 Operation	9
1.4 Performance Specifications	9
LED Indicators	11
2.1 Overview	12
2.2 Power LED	15
2.3 ACT / LNK LEDs	15
2.4 10 / 100 LEDs	16
Installation	17
3.1 Overview	18
3.2 Procedure	19
Power Wiring	23
4.1 Overview	24

Ethernet Wiring	25
5.1 Overview	26
5.2 RJ45 Ethernet Wiring	27
5.3 Ethernet Cable Pin-outs	28
5.4 Ethernet Connector Pin Positions	28
5.5 Ethernet Connector Pin-outs	28
5.6 Cable Distance	29
5.7 Ethernet Fiber Wiring Guidelines	29
5.8 Full or Half Duplex Operation	30
Switch Features	31
6.1 Switch Features	32
Technical Specifications	35
A.1 Technical Specifications	36
Standards and Safety	41
B.1 Standards and Safety	42
B.1.1 CE Statement	42
B.1.2 FCC Statement	42
B.1.3 General Warnings	43
Warranty and Support	45
C.1 Warranty	46
C.2 Technical Support	46
C.2.1 Getting Help	46

1

General Information

Chapter Sections:

- Overview
- Part Numbering Convention
- Operation
- Performance Specifications

1.1 Overview

The Direct-Link Industrial Ethernet Switches and Fiber Converter are easy to install and operate because little or no user configuration is required. Once the Ethernet connections are made and the unit is powered up, it will immediately begin to operate.



Note

The Fiber Converter incorporates the same Layer 2 Ethernet switch technology as all the other DRL-2xx products. Throughout this manual, any mention of Ethernet Switches also applies to the Fiber Converter, unless otherwise stated.

1.2 Part Numbering Convention

Each switch's name indicates the product brand, whether the switch is unmanaged or managed, the number of RJ ports, the number of fiber ports and the connector type.

Figure 1: Part Numbering Convention

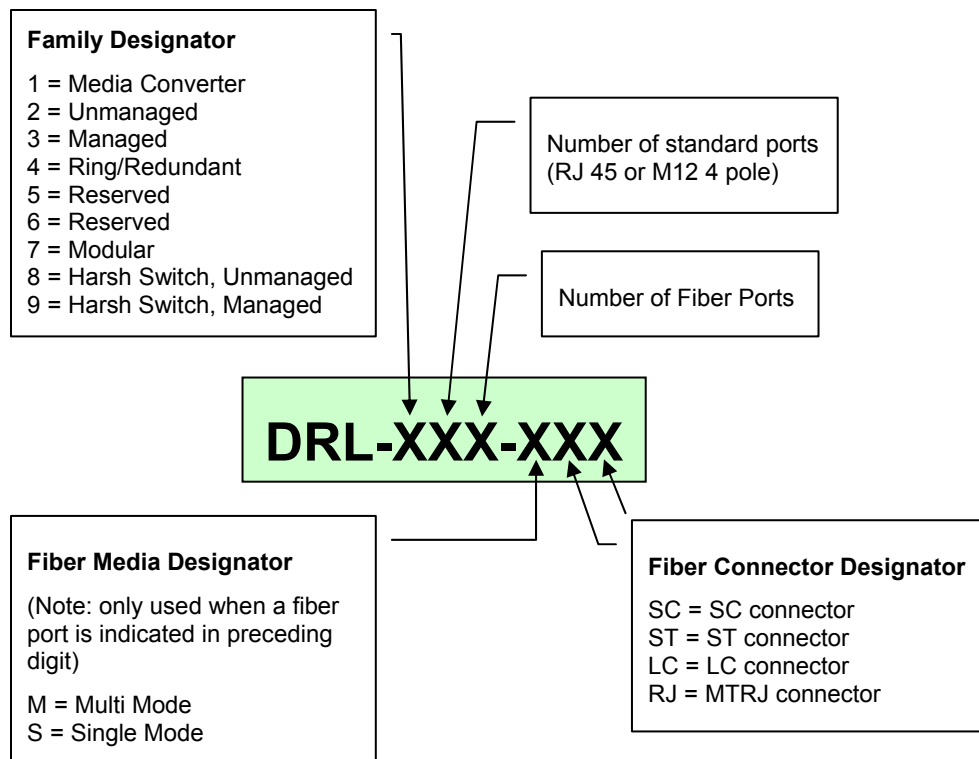

1.3 Operation

Unlike an Ethernet hub, which broadcasts all messages out all ports, the Industrial Ethernet Switches route Ethernet messages via only the appropriate port. The major benefits of this are increased bandwidth and speed, reduction or elimination of message collisions, and deterministic performance when tied with real-time systems.

The Direct-Link Industrial Ethernet Switches support both 10BaseT (10 Mbps) and 100BaseTx (100 Mbps) on their RJ45 ports. Each of these ports independently auto-senses the speed, allowing you to interface to regular or fast Ethernet devices. Some models also have 100BaseFX (100 Mbps) fiber optic port(s).

Refer to Section 6 for more information on Industrial Ethernet Switch operation and features.

1.4 Performance Specifications

The performance specifications are as follows. For complete technical specifications, including switch dimensions, refer to [Appendix A](#).

Table 1: Performance Specifications

Ethernet Switch Type	Unmanaged
Ports (models vary)	10/100BaseT(x) (Shielded RJ45), 100BaseFX (SC or ST connectors)
Required Voltage	10 - 30 VDC (see Appendix A for power consumption for each model)
Ethernet Standards	IEEE 802.3 (10BaseT), 802.3u (100BaseTX), 802.3x (Full Duplex)
Ethernet Protocols	All standard IEEE 802.3 protocols supported
Speed Per Port	RJ45: 10 Mbps/100 Mbps Fiber: 100 Mbps (full duplex)
Ethernet Isolation	1500 Volts RMS (for 1 minute)
Operating Temp.	0 to 60 °C
Humidity	5 to 95% (non-condensing)

2

LED Indicators

Chapter Sections:

- Overview
- Power LED
- ACT / LNK LEDs
- 10 / 100 LEDs

2.1 Overview

The Direct-Link Industrial Ethernet Switches all have a power LED and communication LEDs for each port. Refer to the pictures below for the typical location of these LEDs. The exact location of these LEDs may vary between the different models.

Figure 2: LEDs on DRL-111

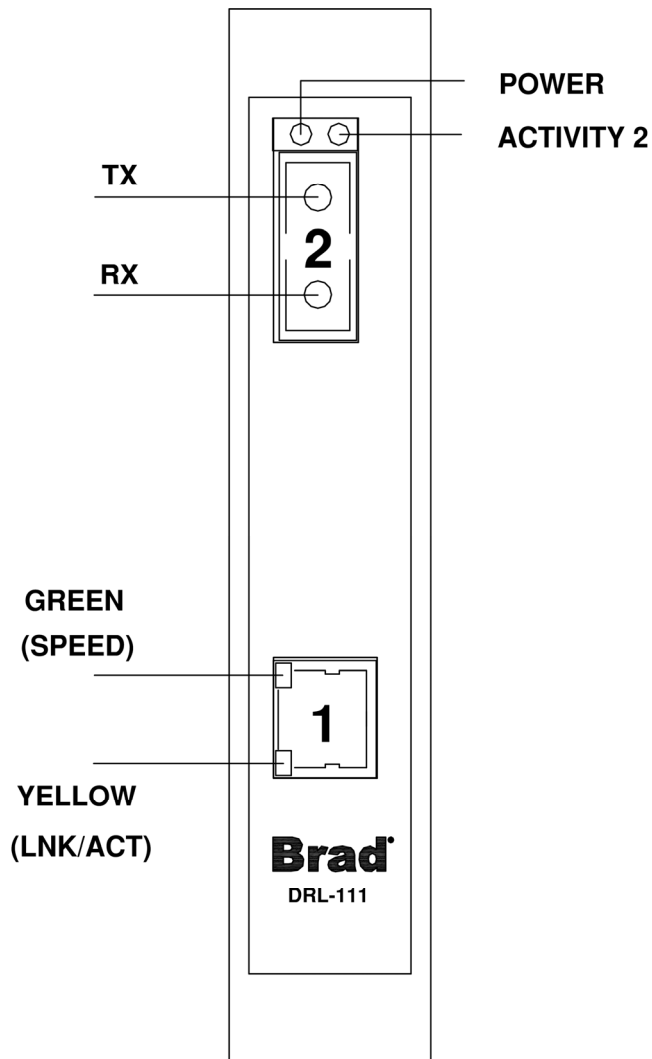

Figure 3: LEDs on DRL-241

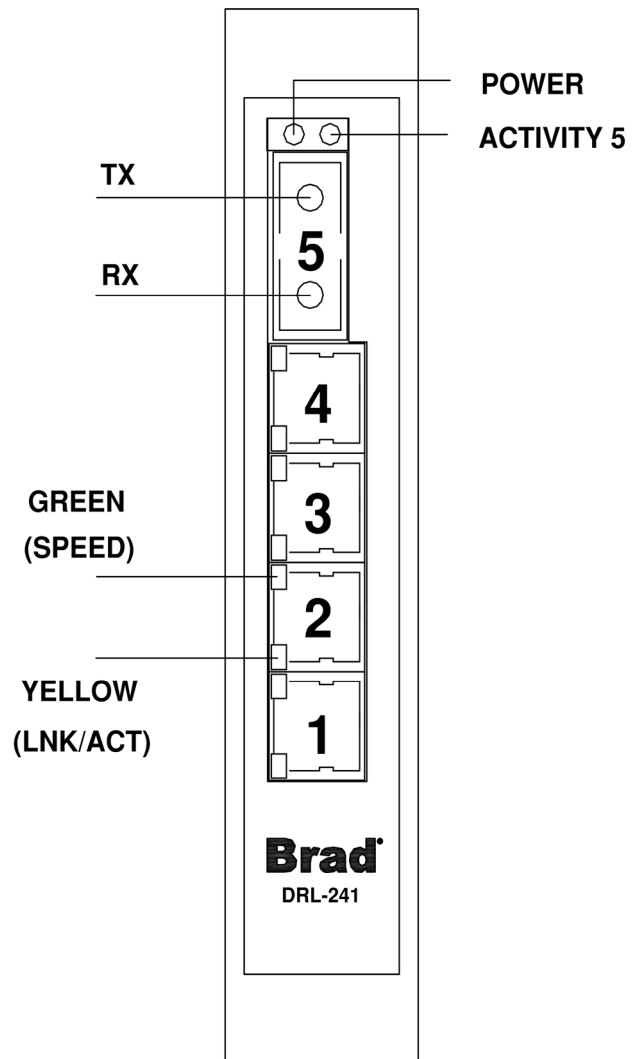

Figure 4: LEDs on DRL-250

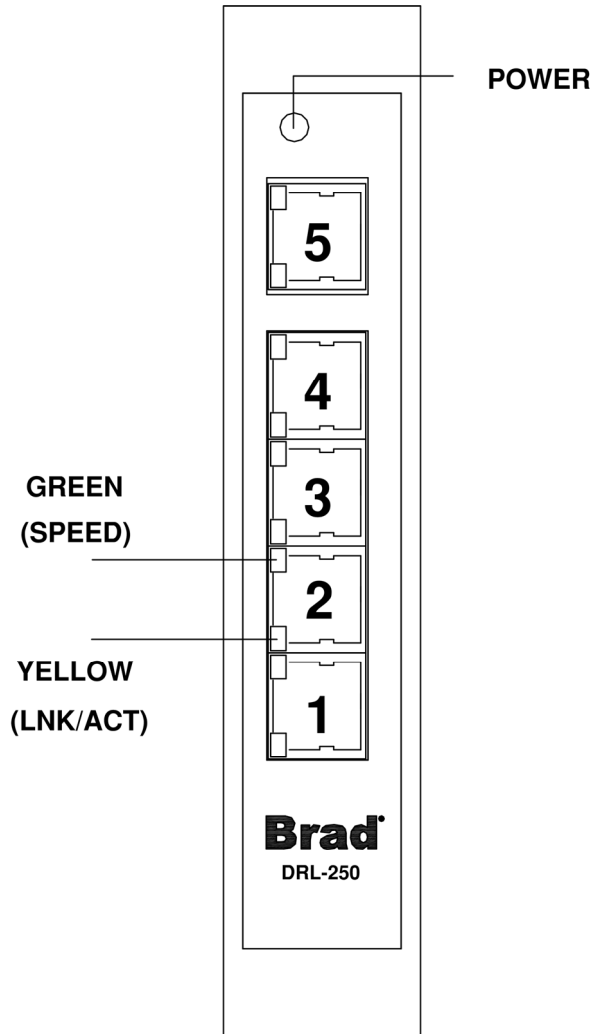

Figure 5: LEDs on DRL-280

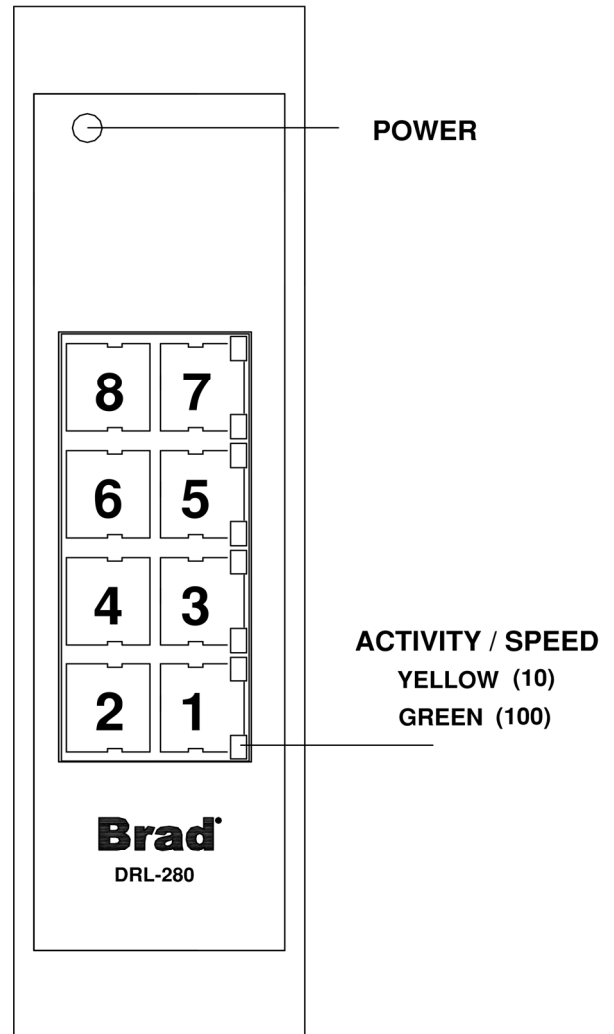

Figure 6: LEDs on DRL-281

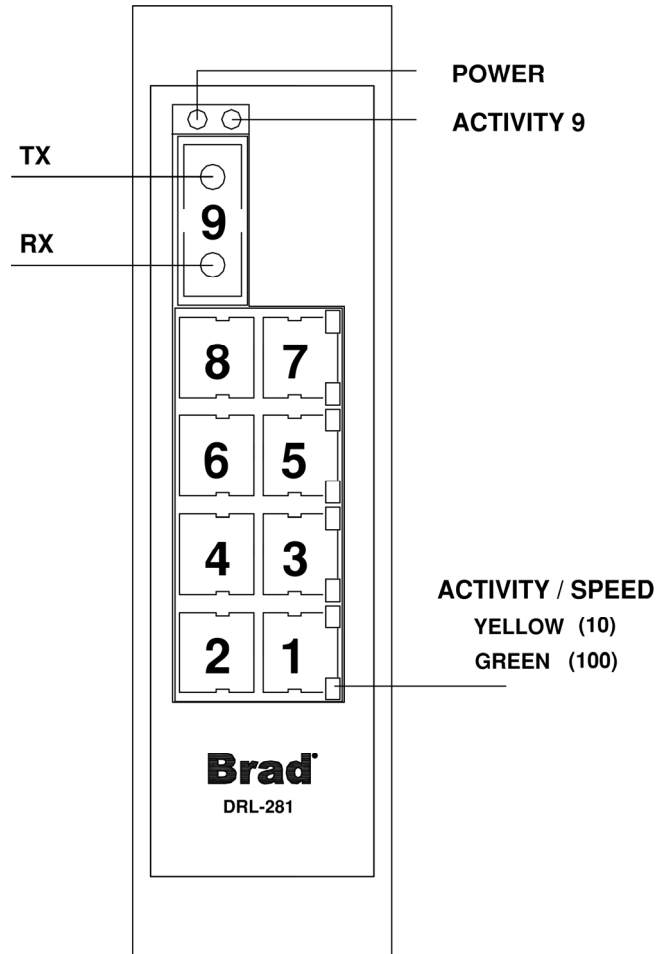
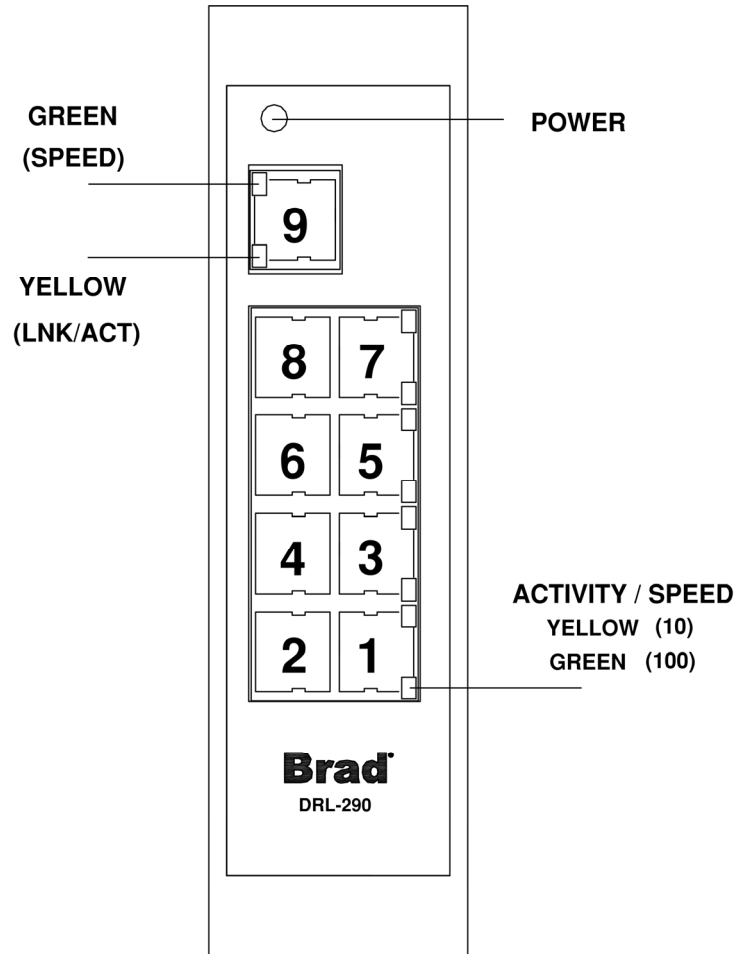

Figure 7: LEDs on DRL-290



2.2 Power LED

This LED will be on solid when proper power has been applied to the unit.

2.3 ACT / LNK LEDs

The activity (ACT) and link (LNK) functionality is combined into one LED. There is one of these LEDs per port. For switches with a fiber port, the Activity LED is located adjacent to the Power LED. On such switches, the Activity LED behaves the same as the other Activity LEDs described in the table below.



Note

The Activity LED is only present on switches that have a fiber port.

Table 2: ACT / LNK LEDs

LED State	Meaning
Off	There is not a proper Ethernet connection (link) between the port and another Ethernet device. Make sure the proper cable type is in use and that it has been plugged securely into the ports at both ends. For Ethernet wiring directions, refer to Chapter 5, Ethernet Wiring .
On Solid (not flashing)	There is a proper Ethernet link between the port and another Ethernet device, but no communications activity is detected.
Flashing	There is a proper Ethernet link between the port and another Ethernet device, and there is communications activity.

2.4 10 / 100 LEDs

These LEDs indicate the communications speed detected on the port. There is one of these LEDs per RJ45 port.



Note

The fiber optic port does not have a 10 / 100 LED because its speed is fixed at 100 Mbps.

Table 3: 10 / 100 LEDs

LED State	Meaning
Off	A 10 Mbps (10BaseT) connection is detected.
On	A 100 Mbps (100BaseTx) connection is detected.



Note

On the DRL-280, DRL-281 and 290, the ACT/LNK and 10/100 LEDs are combined into a single bicolor LED. It behaves as described in Table 2, but the speed is indicated by a yellow state for 10mbps, and a green state for 100mbps.

3

Installation

Chapter Contents:

- Overview
- Procedure

3.1 Overview

The Direct-Link Industrial Ethernet Switches can be snapped onto a standard DIN rail (EN50022) or screwed directly to a flat panel. Refer to the photos below.



Note

- The Ethernet connections for all models are located on the face of the unit. The power connections for all models are located at the top.
- Make sure you allow enough room to route your Ethernet cables.



Warning

Install the Direct-Link Industrial Ethernet Switch in accordance with local and national electrical codes.

3.2 Procedure

The Industrial Ethernet Switches are designed to snap tightly to a standard 35mm DIN rail. This is done by first moving the tabs to an Open position, placing the switch against the rail and then moving the tabs to a Closed position. Refer to Figures 8 and 9 for views of the tabs in the Open and Closed positions.

Figure 8: Switch in Open Position

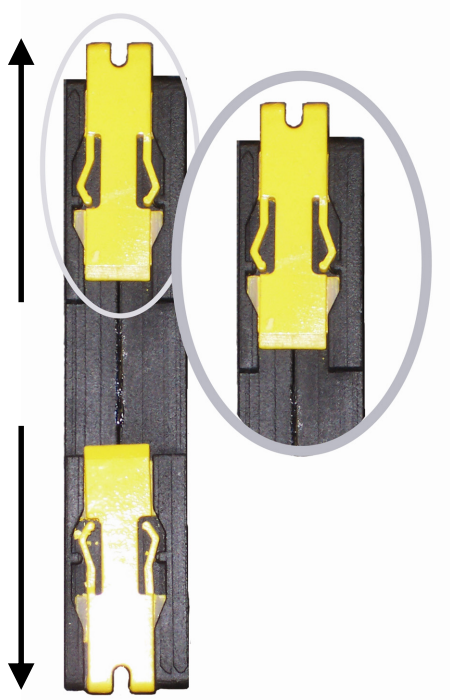
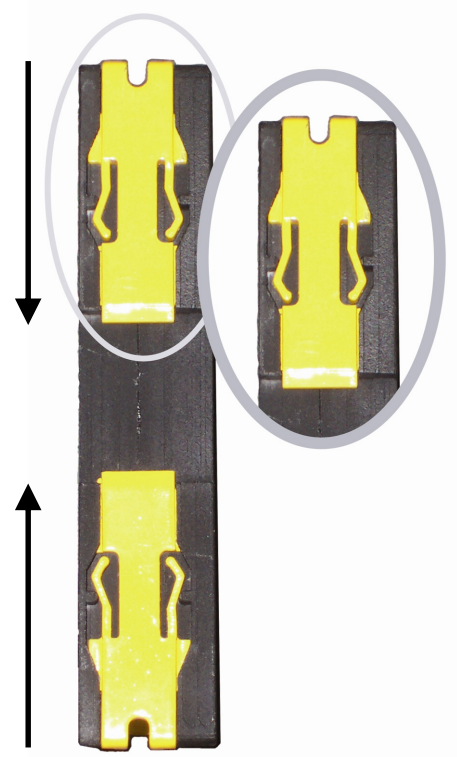

Figure 9: Switch in Closed Position



If the switch is to be mounted using the screw mount, make sure the tabs are in a Closed position, see Figure 9. A #8-32 pan head sheet metal screw is recommended for attaching the switch to the flat panel.

Figure 10: Screw Mount Position



4

Power Wiring

Chapter Contents:

- Overview

4.1 Overview

The switches can be powered from the same DC source that is used to power your I/O devices. 10 to 30 VDC needs to be applied between the P1 terminal and the Common terminal (Figure 11).

The chassis ground terminal should be tied to the panel on chassis ground. To reduce downtime resulting from power loss, the switch can be powered redundantly with a second power supply.

Figure 11: Wiring for Unmanaged Switch

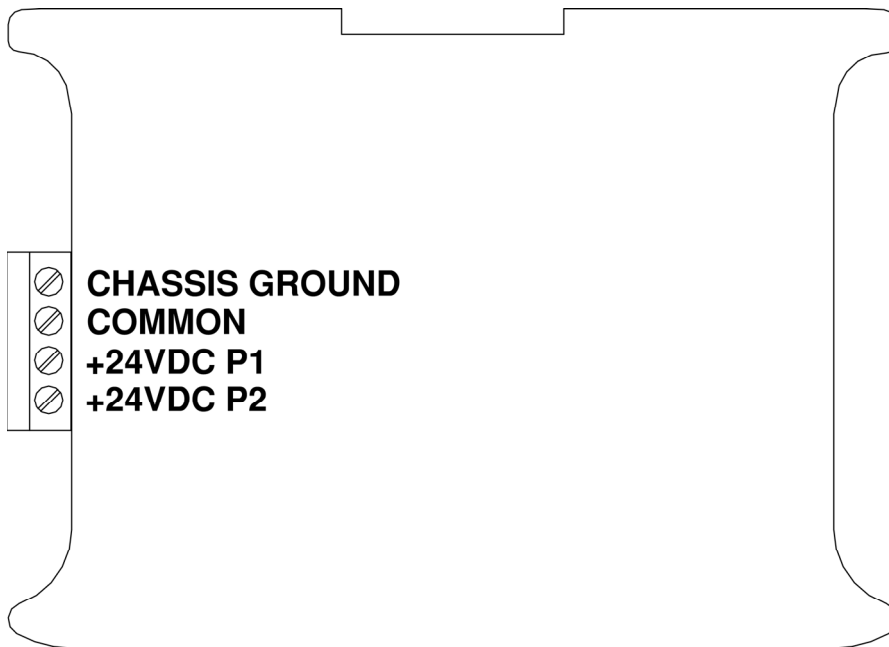

5

Ethernet Wiring

Chapter Contents:

- Overview
- RJ45 Ethernet Wiring
- Ethernet Cable Pin-outs
- Ethernet Connector Pin Positions
- Ethernet Connector Pinouts
- Cable Distance
- Ethernet Fiber Wiring Guidelines
- Full or Half Duplex Operation

5.1 Overview

These switches provide connections to Ethernet devices on the factory floor. Typically, the uplink port or fiber port is used to connect to another Ethernet switch or hub, which is connected to the main Ethernet backbone. The other Ethernet ports are then connected to Ethernet devices such as PLCs, Ethernet I/O, or industrial computers. For increased reliability, electrical isolation is provided on the Ethernet ports.



Note

Follow normal Ethernet wiring practices when installing the Direct-Link Industrial Ethernet Switch and Fiber Converter.

The following figure illustrates the typical switch installation.

Figure 12: Typical Switch Installation

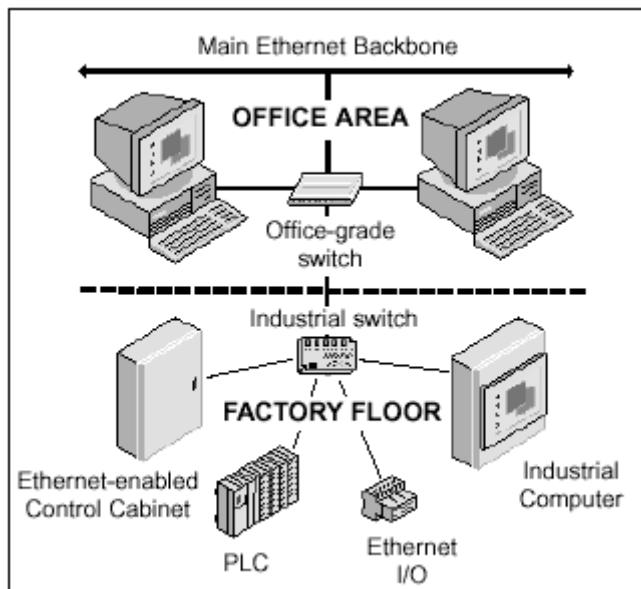

5.2 RJ45 Ethernet Wiring

Use data-quality (not voice-quality) twisted pair cable rated category 5, with standard RJ45 connectors. For best performance, use shielded cable.



Note

These cables are available as straight-thru or cross-over configurations.

All Direct-Link Industrial Ethernet switches have auto-mdi/mdix (auto-crossover) ports that will work with either cable type.

5.3 Ethernet Cable Pin-outs

Table 4: Straight-thru Cable Wiring

Pin 1	Pin 1
Pin 2	Pin 2
Pin 3	Pin 3
Pin 6	Pin 6

Table 5: Cross-over Cable Wiring

Pin 1	Pin 3
Pin 2	Pin 6
Pin 3	Pin 1
Pin 6	Pin 2

5.4 Ethernet Connector Pin Positions

Figure 13: Ethernet Connector Pin Positions

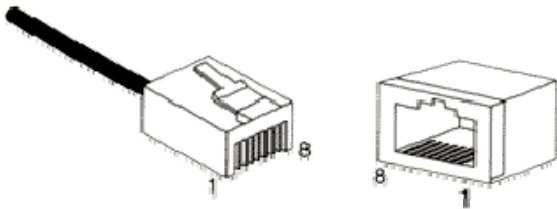

5.5 Ethernet Connector Pin-outs

Table 6: Ethernet Connector Pinouts

Pin #	MDI-X Port	MDI Port (typical for uplink)	Auto-MDI / MDI-X	Ethernet Device Port
1	TX+	RX+	TX/RX+	RX+
2	TX-	RX-	TX/RX-	RX-
3	RX+	TX+	RX/TX+	TX+
6	RX-	TX-	RX/TX-	TX-

5.6 Cable Distance

The maximum cable length for 10/100BaseT(x) is typically 100 meters (328 ft.).

Table 7: Cable Distance

From	To	Maximum Distance
Switch	Switch or Hub	100 meters (328 feet)
Switch or Hub	PLC, Ethernet I/O, PC, etc.	100 meters (328 feet)



Note

Hubs and Switches are different devices. Hubs broadcast all messages out all ports. Switches route messages out of the appropriate port only.

5.7 Ethernet Fiber Wiring Guidelines

The DRL-111, DRL-241 and DRL-281 has one multi-mode or single-mode port. The multi-mode port supports a maximum segment length of 2 km each. The single-mode port supports a maximum segment length of 15 km.

Each fiber optic port on the switch is comprised of a pair of SC or ST connectors. When making your fiber optic connections, make sure that the transmit (TX) port of the switch connects to the receive (RX) port of the other device, and the receive (RX) port of the switch connects to the transmit (TX) port of the other device. See Figure 13 below.

The ACTIVITY LED will be ON solid when you have made a proper connection and will blink to show activity.

Figure 14: 100BaseT Fiber Ports (SC Style)

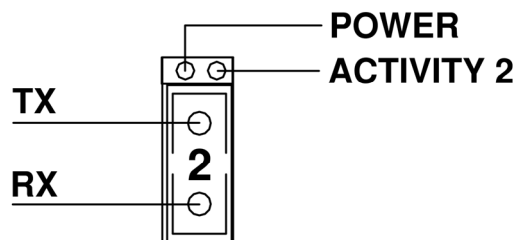

5.8 Full or Half Duplex Operation

The RJ45 ports will auto-sense for Full or Half duplex operation. The fiber optic port is fixed at Full duplex operation.

6

Switch Features

Chapter Contents:

- Switch Features

6.1 Switch Features

Here's a brief explanation of the features found in the Direct-Link Industrial Ethernet Switches.

10BaseT and 100BaseTx Auto-Detection

Standard Ethernet (10BaseT) has a maximum speed of 10 Mbps. Fast Ethernet (100BaseTx) has a maximum speed of 100 Mbps. The RJ45 ports on the switches automatically select the appropriate speed.

100BaseFX (Multi-mode and Single-mode) Fiber Optic Port

The fiber optic port found on some models is classified as 100BaseFX and supports 100 Mbps operation only. Both multi-mode and single-mode models are available. Multi-mode fiber has a large core diameter relative to a wavelength of light, and is typically 62.5 microns. Light injected into the fiber travels through many different paths, causing multiple modes to occur at the receiving end. This dispersion of light limits the distance for multi-mode to about 2km. Single-mode fiber has a thin core diameter of typically 10 microns, which eliminates multi-mode dispersion and allows distances of more than 15km.

1K or 2K MAC Addresses with Automatic Learning, Aging and Migration

Each Ethernet device inserts its unique "MAC" address into each message it sends out. The port on the switch used for a given MAC address is automatically learned when a frame is received from that address. Once an address is learned, the switch will route messages to the appropriate port only, instead of broadcasting messages out all ports like a hub. A timestamp is also placed in memory when a new address is learned. This timestamp is used with the aging feature, which will remove unused MAC addresses from the table after 300 seconds. If a device moves, the associated port on the switch will be changed (migrated) as needed. Up to 1,024 MAC addresses can be stored and monitored at any time on the DRL-111, DRL-241 and DRL-250. For the DRL-280, DRL-281 and DRL-290 this increases to 2,048 MAC addresses.

Auto-Crossover (Auto-mdi/mdix)

The RJ45 ports will automatically detect the cable type (straight-thru vs. cross-wired) and re-configure themselves accordingly.

Auto-Sensing or Auto-Negotiating Speed

The RJ45 ports will auto-negotiate with the connected device to determine the optimal speed (10 Mbps vs. 100 Mbps).

Automatic Power Saving

If there is no cable on a port, most of the circuitry for that port is disabled to save power.

Backoff Operation

The switches will drop a packet after 16 collisions.

Back Pressure for Half-Duplex

The switches will apply “back pressure” when necessary with half-duplex operation. This will reduce congestion on busy networks.

Buffering

SRAM is used for buffering the messages. The DRL-111, DRL-241 and DRL-250 has 512 KB. The DRL-280, DRL-281 and DRL-290 have 1 MB of SRAM for buffering.

Unmanaged Operation

The switches require no supervisory processor to operate properly.

Flow Control

The switches automatically support flow control frames on both the transmit and receive sides.

Forwarding

The switches support store and forward mode. They forward messages with known addresses out the appropriate port only. Messages with unknown addresses, broadcast messages, and multicast messages get forwarded out all ports, except the source port. The switches will not forward error packets, 802.3x pause frames, or “local” packets.

Full/half-Duplex Operation

The switches’ RJ45 ports support both full and half duplex flow control. The fiber optic port supports full duplex only.

Illegal Frames

Illegal frames, as defined by IEEE 802.3, will be dropped. This includes short frames, long frames and FCS error frames.

IEEE 802.3 Compliant

The switches abide to the IEEE 802.3 standard for 10BaseT, 100BaseTX, and 100BaseFX Ethernet communications.

Late Collision

If a packet experiences collisions after 512 bit times of transmission, it will be dropped.

Latency

The typical latency of a message is 5 microseconds or faster. The latency is the time it takes a message to be routed internally to a switch from one port to another.

Plug and Play

This means that most of the switches’ functions or features are automatic and that no optional parameters need to be set. Just plug in your Ethernet cables, apply power, and the unit will immediately begin to operate.

Protocol Independent

The switches simultaneously support all popular Ethernet protocols and networks, such as TCP/IP, the Internet (IP), UD and NetBEUI that run over standard Ethernet (IEEE 802.3).



Technical Specifications

Appendix Contents:

- Technical Specifications

A.1 Technical Specifications

The hardware technical specifications for the Direct-Link Industrial Ethernet Switches are as follows.

Table 8: 10/100BaseT(x) Ports:

10/100BaseT(x) ports	Shielded RJ45
Protocols supported	All standard IEEE 802.3
Ethernet compliancy	IEEE 802.3, 802.3u, 802.3x
Auto-crossover (Auto-mdi/mdix)	Supported on all ports
Auto-negotiating	10BaseT or 100BaseTX
Flow control	Half or full duplex
Ethernet isolation	1500 VRMS 1 minute
Plug and play	Yes
Cable requirements	Twisted pair (Cat. 5) (shielded recommended)
Max. cable distance	100 meters

Table 9: Fiber Port: (multi-mode)

100BaseFX ports	1
Fiber port mode	Multi-mode
Fiber port connector	Duplex SC or ST
Optimal fiber cable	50/125, 62.5/125 μm
Center wavelength	1300 nm
TX output power	Contact WSE for optical details.
RX input sensitivity	
Maximum distance	4 km (see web for details)
Half and full duplex	Full duplex
Ethernet compliance	100BaseFX
Eye safety	IEC 60825-1, Class 1; FDA 21 CFR 1040.10 and 1040.11

Table 10: Fiber Port: (Single-mode)

100BaseFX ports	1
Fiber port mode	Single-mode
Fiber port connector	Duplex SC or ST
Optimal fiber cable	9/125, 10/125 µm
Center wavelength	1300 nm
TX output power	Contact WSE for optical details.
RX input sensitivity	
Maximum distance	20 km
Half and full duplex	Full duplex
Ethernet compliance	100BaseFX

Table 11: General Specifications:

Forwarding mode	Store and forward	
Latency (typical)	5 usec (time to route a message from one port to another internally to switch)	
MAC addresses	1K or 2K	
Address learning	Automatic	
Address aging	Remove old address after 300s	
Address migration	Automatic	
Backoff operation	Drops after 16 collisions	
Back pressure	Automatic for half-duplex	
Buffer memory	512KB (DRL-111, -241 & -250) or 1MB (DRL-280, -281 & -290)	
Buffer size	128 bytes per buffer (all models)	
Illegal frames	Dropped per 802.3	
Late collisions	Dropped after 512 bit times	
Required supply voltage	10 – 30 VDC	
Power consumption (typical)	2W (DRL-111); 2.16W (DRL-250); 3.16W (DRL-241); 336W (DRL-280); 4.36W (DRL-281), 4W (DRL-290)	
Power saving	Automatic	
Mounting	DIN rail or panel direct	
Environmental		
Operating temperature range	0 to 60 C	
Storage temperature range	-40 to 85 C	
Humidity	5 to 95 % (non-condensing)	
Vibration	IEC68-2-6	
Electrical safety	 EN61010-1	
EMI emissions		FCC part 15, ICES 003, EN55011
EMC immunity		EN61326
Packaging	IP30 protection	
Dimensions	See Figures 14, 15 and 16 for details.	

Figure 15: Unmanaged Switch, Side View

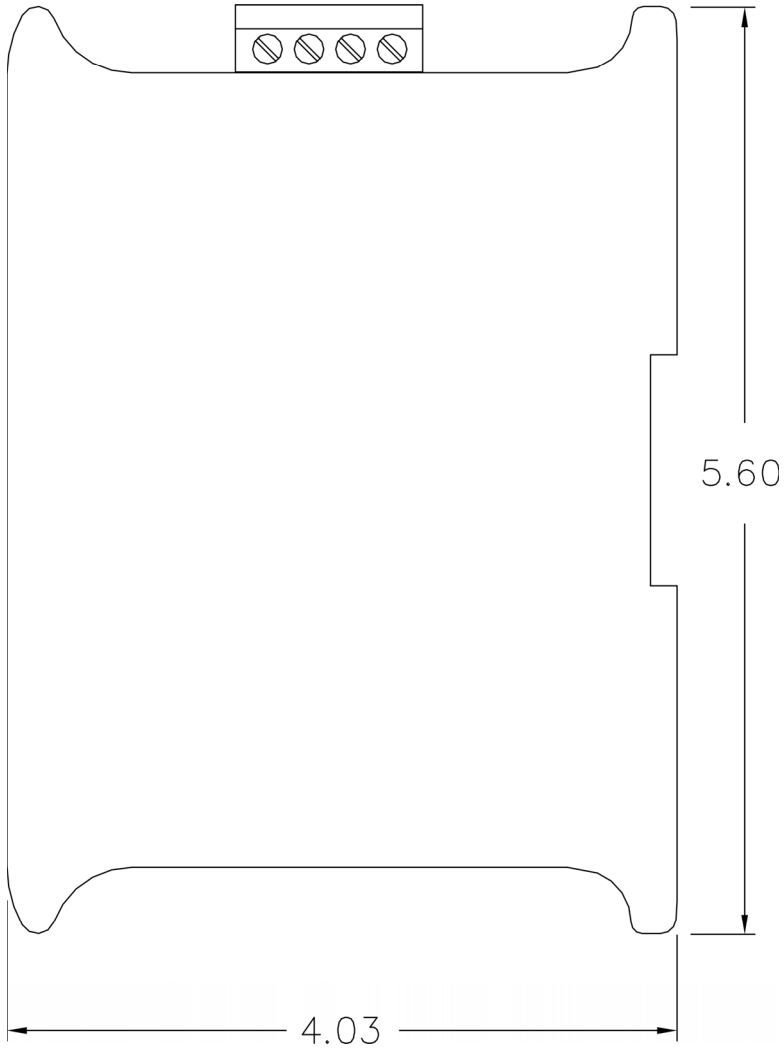

Figure 16: Unmanaged Switch,
Front View (DRL-280, DRL-281 & DRL-290)

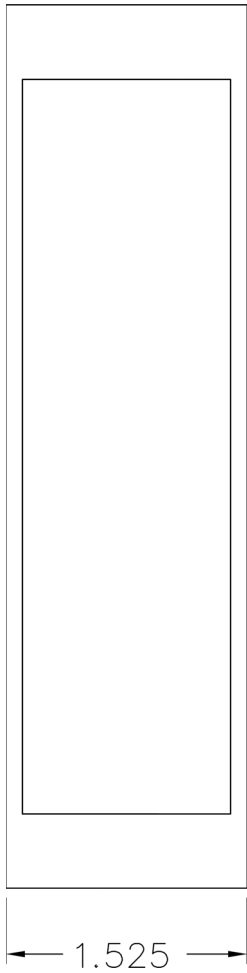
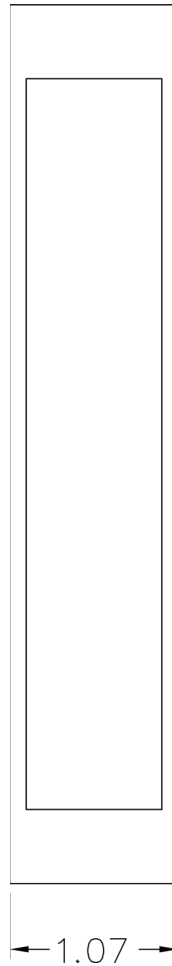

Figure 17: Unmanaged Switch,
Front View (DRL-111, DRL-241 & DRL-250)



B

Standards and Safety

Appendix Sections:

- Standards and Safety

B.1 Standards and Safety

The applicable standards and certifications are:



European Directives



US Emissions

B.1.1 CE Statement

Electrical safety - EN61010-1 (IEC61010)

EMI emissions - FCC part 15, ICES 003, EN55011; Class A

EMC immunity – EN61326

B.1.2 FCC Statement

This equipment complies with Part 15 of the FCC Rules. Operation is subject to the following two conditions: (1) this device may not cause harmful interference, and (2) this device must accept any interference received, including interference that may cause undesired operation.



Note

This equipment has been tested and found to comply with the limits for a Class A digital device, pursuant to Part 15 of the FCC Rules. These limits are designed to provide reasonable protection against harmful interference when the equipment is operated in a commercial environment. This equipment generates, uses and can radiate radio frequency energy and, if not installed and used in accordance with the instruction manual, may cause harmful interference to radio communications. Operation of this equipment in a residential area is likely to cause harmful interference, in which case the user will be required to correct the interference at his own expense.



Warning

Changes or modifications not expressly approved by Woodhead Industries could void the user's authority to operate the equipment.

B.1.3 General Warnings



Caution

This equipment is neither designed for, nor intended for operation in installations where it is subject to hazardous voltages and hazardous currents.



Note

To maintain compliance with the limits and requirements of the EMC Directive, it is required to use quality interfacing cables and connectors when connecting to this device.



Note

The supply voltage for this equipment must be delivered as Separated Extra Low Voltage (SELV).

C

Warranty and Support

Appendix Sections:

- Warranty
- Technical Support

C.1 Warranty

For warranty information pertaining to the switch, refer to <http://www.mysst.com/warranty.asp>.

C.2 Technical Support

Please ensure that you have the following information readily available before calling for technical support:

- Switch type and serial number
- Details of the problem you are experiencing: switch type and version, target network, and circumstances that may have caused the problem

C.2.1 Getting Help

Technical support is available during regular business hours by telephone, fax or email from any Woodhead Software & Electronics office, or from <http://www.woodhead.com>. Documentation and software updates are also available on the Web site.

North America

Canada:

Tel: 1-519-725-5136

Fax: 1-519-725-1515

Email: SupportNA@woodhead.com

Europe

France:

Tel: 33-(0)2-32-96-04-22

Fax: 33-(0)2-32-96-04-21

Email: SupportEU@woodhead.com

Germany:

Tel: 49-711-782-374-22

Fax: 49-711-782-374-11

Email: SupportEU@woodhead.com

Italy:

Tel: 39-010-595-4052

Fax: 39-010-595-6925

Email: SupportEU@woodhead.com

Other countries:

Tel: 33-(0)2-32-96-04-23

Fax: 33-(0)2-32-96-04-21

Email: SupportEU@woodhead.com

Asia-Pacific

Japan:

Tel: 81-3-5791-4621

Fax: 81-3-5791-4688

Email: SupportAP@woodhead.com

Singapore:

Tel: 65-6261-6533

Fax: 65-6261-3588

Email: SupportAP@woodhead.com

China:

Tel: 86-21-5835-9885

Fax: 86-21-5835-9980

Email: SupportAP@woodhead.com

For the most current contact details, please visit <http://www.woodhead.com/>.