

TECHNOTE

IOL-CALL Function block with HarhIO PROFINET IO-Link Master

Rev	Date	File Name
1.0	05/12/2017	IOL-CALL Function block with HarhIO PROFINET IO-Link Master

- Product line: Brad® Harsh-Duty IO Modules
- Part number: TCIEP-888P-D1U
- Environment: /
- Related documents: Harsh-Duty IO Modules User's manuals
- Restriction : /

Although every effort has been made to ensure the accuracy of this document, all information is subject to change without notice. Molex takes no liability for any errors in this document or for direct, indirect, or consequential damage resulting from the use of this manual.

TECHNOTE

IOL-CALL Function block with HarshIO PROFINET IO-Link Master

1. The IO-Link function block IOL_CALL

The IO-Link function block IOL_CALL is specified in the IO-Link specification.

The following figure shows IO-Link function block in accordance with IO-Link specification

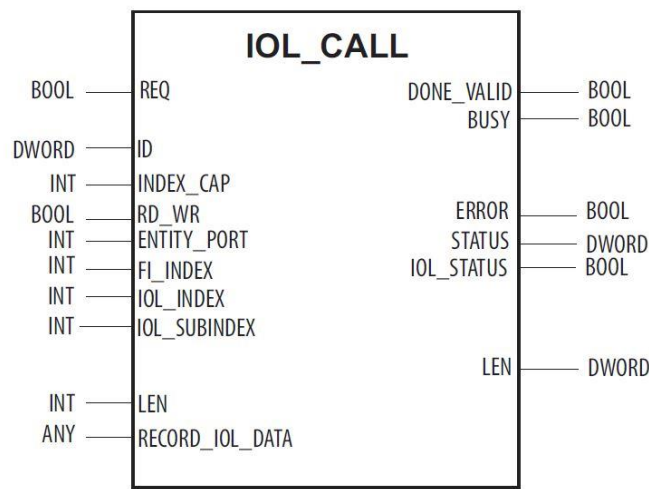

This function block allows to read/write acyclic parameters directly from/to the IO-Link device connected on the IO-Link port of the HarshIO using IO-Link ISDU objects (Index Service Data Unit).

The IO-Link function block allows the following tasks:

- (Re)configuration of an IO-Link device
- Diagnostics of an IO-Link device
- Executing IO-Link port functions
- Saving/recovering IO-Link device parameters

In this technical manual, we will provide two examples of use of this function block:

- 1) [Reading the vendor name of the Molex IO-Link device](#)
- 2) [Data storage parametrization](#)



Note!

Depending on the PLC manufacturer, the IO-Link function block IOL_CALL can differ from the specification.

The HarshIO device supports the Siemens IO-Link function block called IO_Link_DEVICE. It is validated with the IOL_CALL for TIA Portal v13 and v14.

For having a list of ISDU objects supported by any IO-Link device, please refer to the user's manual of this device

TECHNOTE

IO-LINK Function block with HarhIO PROFINET IO-Link Master



Note!

The IO-Link function block IOL_CALL is downloadable separately from Siemens website, and then it must be imported into the TIA Portal.

The HarshIO device supports the IO-Link function block called “IO_Link_DEVICE”

a. Importing the IO-Link function block into TIA Portal.

After downloading the IO-Link function block, you must import it into TIA Portal project:

- 1) Open “Libraries” Tab
- 2) Right click in “Global libraries” field and click on “Retrieve library”
- 3) Browse to the folder that contains the IO-Link function block Library called “IO_LINK_Library_V14.zal14”, select it and define a folder where you prefer that TIA Portal install the data of this library

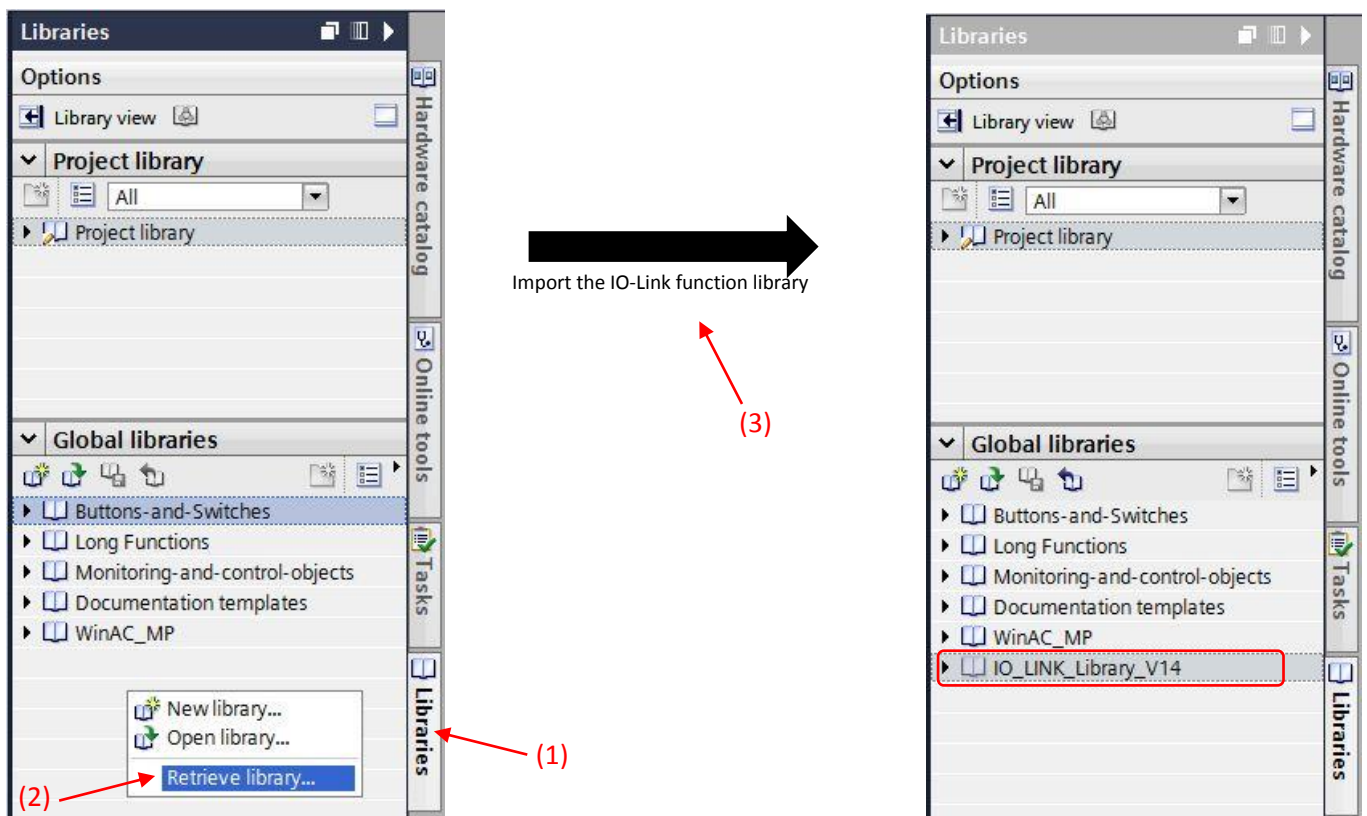

TECHNOTE

IO-LINK Function block with HarhIO PROFINET IO-Link Master

b. Inserting the function block into your project.

Once the import is completed, you will find in the “Global libraries” the IO-Link function block called “IO_LINK_DEVICE”.

The data on an IO-Link device can be uniquely addressed with index and subindex.

To use the function block “IO_LINK_DEVICE” in your actual TIA portal project, please follow the steps:

- 1) From the “Global Libraries, drag and drop the block « IO-LINK DEVICE » to the folder “Program blocks” as shown below

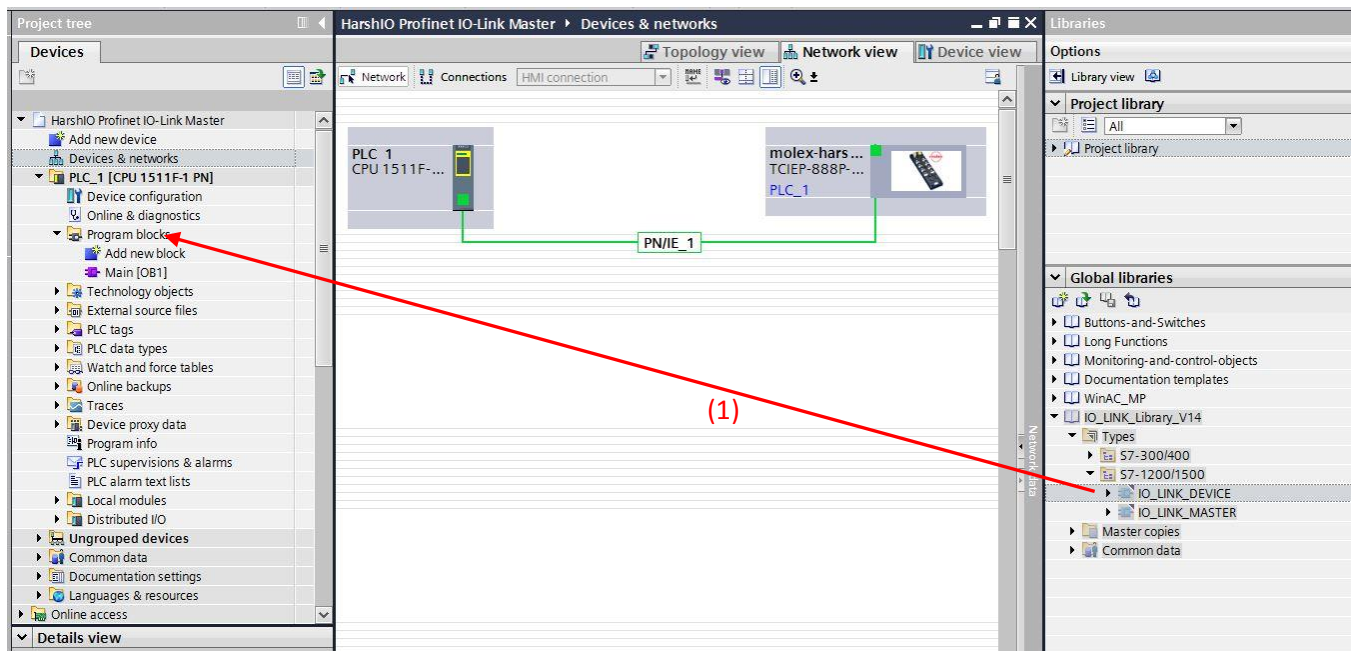

Once done, the block “IO_LINK_DEVICE” will appear under “Program blocks” list.

TECHNOTE

IOL-CALL Function block with HarhIO PROFINET IO-Link Master

- 2) Open the main program “Main [OB1]” by double-clicking it.
- 3) Drag and drop the “IO_LINK_DEVICE” function block to OB1.
- 4) Confirm the “Call options” dialog box with “OK”, and check that a “DB1” function block is generated automatically in the project tree.

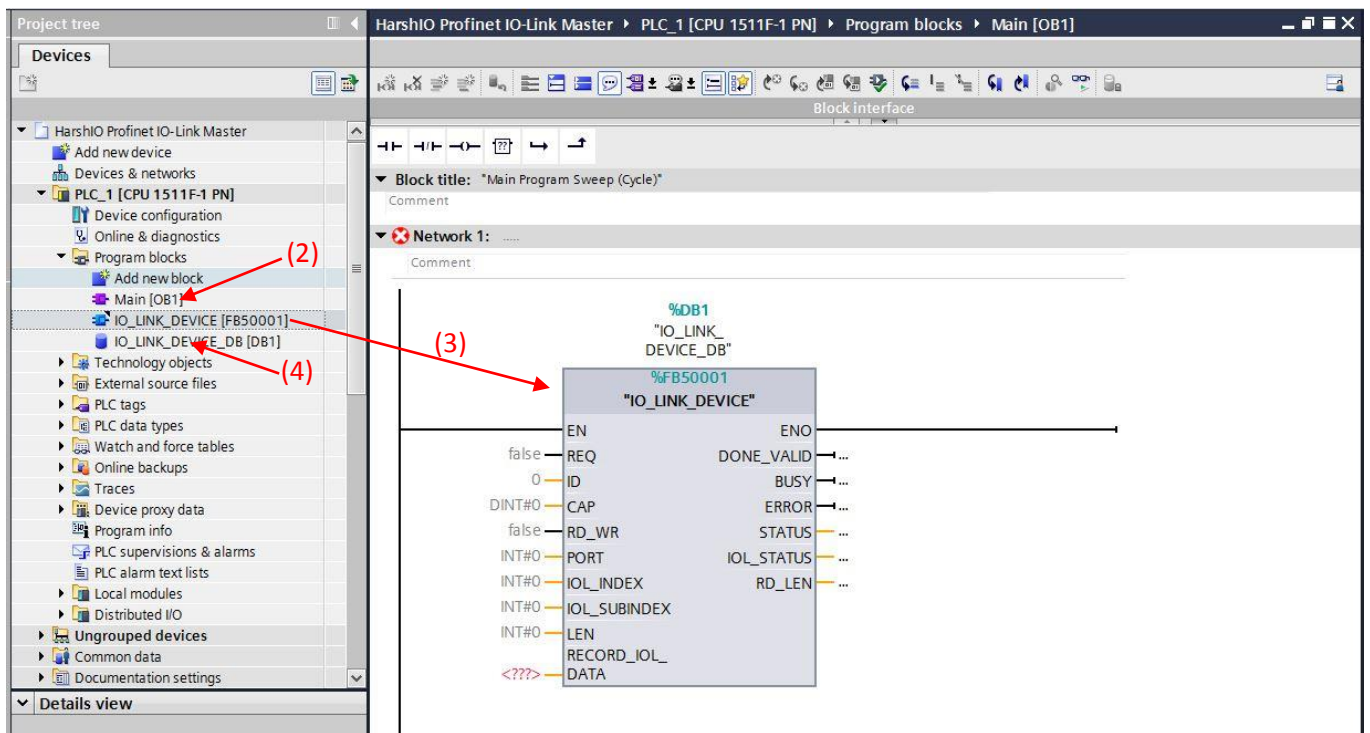

TECHNOTE

IOL-CALL Function block with HarhIO PROFINET IO-Link Master

c. IOL_CALL parameter description.

The structure of the function block is as follow.

Input parameters

Parameter	Data type	Description
REQ	BOOL	A rising edge triggering the data transfer
ID	HW_IO	Hardware identifier of the IO-Link communication module For the HarshIO, use the HW_ID of the Digital Input/Output (DIO) module
CAP	DINT (S7-1200/1500)	Access point of the IO_LINK_DEVICE function Molex = 255dec. --> (PROFINET INDEX)
	INT (S7-300/400)	
RD_WR	BOOL	Read/Write access 0: Read 1: Write
PORT	INT	The channel number on which the IO-Link device is connected Possible values: 0,2,4,6,8,10,12,14
IOL_INDEX	INT	Parameter index Possible values: 0 - 32767
IOL_SUBINDEX	INT	Parameter subindex 0: entire record 1 - 255: parameter from record
LEN	INT	Length of the data to be written (net data) Read: 0 - 232 (not relevant) Write: 1 - 232

Output parameters

Parameter	Data type	Description
DONE_VALID	BOOL	Validity of the data transmission 0: Data not valid 1: Data valid
BUSY	BOOL	Data transmission progression state 0: Transmission completed 1: Transmission in progress
ERROR	BOOL	Error while executing the Read or Write access 0: No error 1: Abort with error
STATUS	DWORD	Communication error status (Status of the acyclic communication) See STATUS – Communication error description
IOL_STATUS	DWORD	IO-Link error status See IOL_STATUS – IO-Link error description
RD_LEN	INT	Length of the data read/number of bytes

Input/ Output parameter

Parameter	Data type	Description
RECORD_IOL_DATA	ARRAY [0..231] of BYTE	Source/destination for the data to be read/written.

TECHNOTE

IOL-CALL Function block with HarshIO PROFINET IO-Link Master

STATUS – Communication error description.

The structure of the STATUS communication error contains 4 bytes:

Byte 3	Byte 2	Byte 1	Byte 0
Manufacturer specific identifier (not always applicable)	0x80: Specifies the error as an error of acyclic communication	Error code	Vendor specific identifier (Not always applicable)



Note!

The STATUS communication error contains error information of the internal system function (Read Data Record (RDREC) and Write Data Record (WRREC)) used by the IOL_CALL function block.

For more information about the STATUS error codes, please refer to RDREC and WRREC documentation in Siemens TIA Portal tool.

The table below shows example of code obtained when using the HarshIO module with IOL_CALL function block.

Status Code	Name	Description
0x00700200	INTERMEDIATE_CALL	Data record transfer already active. The request was sent already and waiting for a response from the IO-Link Master. If there is an error after this state, decreasing the scan cycle of the PLC CPU can be a solution.
0xC0809300	HARDWARE_IDENTIFIER_NOT_CONFIGURED	Wrong ID parameter: ID not existing in the hardware configuration obtained when configuring the HarshIO module
0xDF80B039	MASTER_FEATURE_NOT_SUPPORTED	Function not supported by the Molex HarshIO module (Wrong PROFINET Index) Possible solution: The PROFINET Index for the Molex HarshIO module is 255 dec.
0xDF80B200	ACCESS_INVALID_DESTINATION	Wrong ID parameter: ID exists in the hardware configuration but it is not the good one. Possible solution: Use the hardware identifier of the standard DIO module not the hardware identifier of another module.
0xDF80B500	STATE_CONFLICT	The HarshIO module is not ready Possible cause: The HarshIO receives two IOL_CALL request at the same time or receives the second request before finishing the first request.

TECHNOTE

IOL-CALL Function block with HarhIO PROFINET IO-Link Master

IOL_STATUS – IO-Link error description.

The structure of the IOL_STATUS communication error contains 4 bytes:

Byte 3	Byte 2	Byte 1	Byte 0
IOL_M Error Codes Meaning in table “IOL_M Error Codes” below		IOL Error Types Meaning in table “IOL Errors” below	

IOL_M Error Codes

Status Code	Name	Description
0x0000	No error	No error
0x0002	BUSY	The HarshIO IO-Link Master is busy (action in progress)
0x7000	IOL_CALL conflict	Unexpected read/write request by the IOL_CALL function block
...	reserved	Reserved
0x8000	Timeout	Timeout, IOL Master or IOL device port busy
0x8001	Wrong port address	Port address not available
0x8002	Wrong index	Wrong index configured in the parameter
0x8003	Wrong sub index	Wrong subindex configured in the parameter
0x8004	No Device	No device connected on the IO-Link channel
0x8005	Wrong LEN for writing	Value of parameter LEN is not correct for writing
0x8006	Wrong LEN for reading	Value of parameter LEN is not correct for reading
0x8007	Port not configured as IO-Link	The port is configured as DI/DO, SI/SO or not configured
0x8053	Access refused	Wrong parameter set to the IOL_CALL (ID, CAP, ...)

IOL Errors

Status Code	Name	Description
0x0000	No error	No error
0x1000	Unknown error	General malfunction
0x1001 to 0x17FF	Reserved	Reserved
0x1800 to 0x18FF	Vendor specific	Vendor specific
0x1900 to 0x3FFF	Reserved	Reserved
0x4000	Temperature fault	Overload
0x4001 to 0x420F	Reserved	Reserved
0x4210	Excess temperature device	Device temperature over-run - Clear source of heat
0x4211 to 0x421F	Reserved	Reserved
0x4220	Device temperature under-run	Device temperature under-run - Insulate Device
0x4221 to 0x4FFF	Reserved	Reserved
0x5000	Device hardware fault	Device hardware fault - Device exchange
0x5001 to 0x500F	Reserved	Reserved
0x5010	Component malfunction	Component malfunction - Repair or exchange
0x5011	Non volatile memory loss	Non volatile memory loss - Check batteries
0x5012	Batteries low	Batteries low - Exchange batteries
0x5013 to 0x50FF	Reserved	Reserved
0x5100	General power supply fault	General power supply fault – Check availability
0x5101	Fuse blown/open	Fuse blown/open – Exchange fuse

TECHNOTE

IOL-CALL Function block with HarhIO PROFINET IO-Link Master

0x5102 to 0x510F	Reserved	Reserved
0x5110	Supply High voltage	Primary supply voltage over-run – Check tolerance
0x5111 to 0x-5119	Supply low voltage	Supply voltage under-run – Check tolerance
0x5200 to 0x5FFF	Reserved	Reserved
0x6000	Device software fault	Device software fault – Check firmware revision
0x6001 to 0x631F	Reserved	Reserved
0x6320	Parameter error	Parameter error – Check data sheet and values
0x6321	Parameter missing	Parameter missing – Check data sheet
0x6322 to 0x634F	Reserved	Reserved
0x6350	Parameter changed	Parameter changed – Check configuration
0x6351 to 0x76FF	Reserved	Reserved
0x7700	Wire break of a subordinate device	Wire break of a subordinate device – Check installation
0x7701 to 0x770F	Wire break of subordinate device 1 ...device 15	Wire break of subordinate device 1 ...device 15 – Check installation
0x7710	Short circuit	Short circuit – Check installation
0x7711	Ground fault	Ground fault – Check installation
0x7712 to 0x8BFF	Reserved	Reserved
0x8C00	Technology specific application fault	Technology specific application fault – Reset Device
0x8C01	Simulation active	Simulation active – Check operational mode
0x8C02 to 0x8C0F	Reserved	Reserved
0x8C10	Excess process variable range	Process variable range over-run – Process Data uncertain
0x8C11 to 0x8C1F	Reserved	Reserved
0x8C20	Excess measurement range	Measurement range over-run – Check application
0x8C21 to 0x8C2F	Reserved	Reserved
0x8C30	Too low process variable range	Process variable range under-run – Process Data uncertain
0x8C31 to 0x8C3F	Reserved	Reserved
0x8C40	Maintenance required	Maintenance required – Cleaning
0x8C41	Maintenance required	Maintenance required – Refill
0x8C42	Maintenance required	Maintenance required – Exchange wear and tear parts
0x8C43 to 0x8C9F	Reserved	Reserved
0x8CA0 to 0x8DFF	Vendor Specific	Vendor Specific
0x8E00 to 0xAFFF	Reserved	Reserved
0xB000 to 0xBFFF	Reserved for profiles	Reserved for profiles
0xC000 to 0xFEFF	Reserved	Reserved
0xFF00 to 0xFFFF	Specific EventCodes	Specific EventCodes



Note!

In case of obtaining an IOL status code that have a value located in “Reserved” or “Vendor specific” range, please refer to the user’s manual of the IO-Link device that you are using for having details on this error code.

TECHNOTE

IOL-CALL Function block with HarhIO PROFINET IO-Link Master

2. Examples:

a. Reading IO-Link device parameters using IOL_CALL.

In this example, we will use the IO-Link function block IOL_CALL (IOL_LINK_DEVICE) for reading Vendor name of the IO-Link device connected physically on the IO-Link channel of the Molex HarshIO Profinet IO-Link Master.

Used hardware:

- Siemens S7, CPU 1511F-1 PN (Firmware v2.0)
- Molex IO-Link Digital Hub 12x inputs/4x outputs TEDIO-8B4P-808 (Product Version 1.0.0.0 or upper)
- Molex HarshIO Profinet IO-Link Master (Product Version 1.0.0.0 or upper)

Used Software:

- Siemens Totally Integrated Automation Portal v14

Hardware configuration:

In this example project, the IO-Link device “Molex IO-Link Digital Hub 12x inputs/4x outputs” will be connected physically on the port 2 (channel 4) of the Molex HarshIO Profinet IO-Link Master. For doing this configuration in the hardware configuration in TIA Portal tool, you need to drag and drop the IO-Link device module named “Digital Hub 12x Inputs + 4x Outputs” from Catalog to the port 2 of the HarshIO IO-Link Master as follow:

TECHNOTE

IOL-CALL Function block with HarhIO PROFINET IO-Link Master

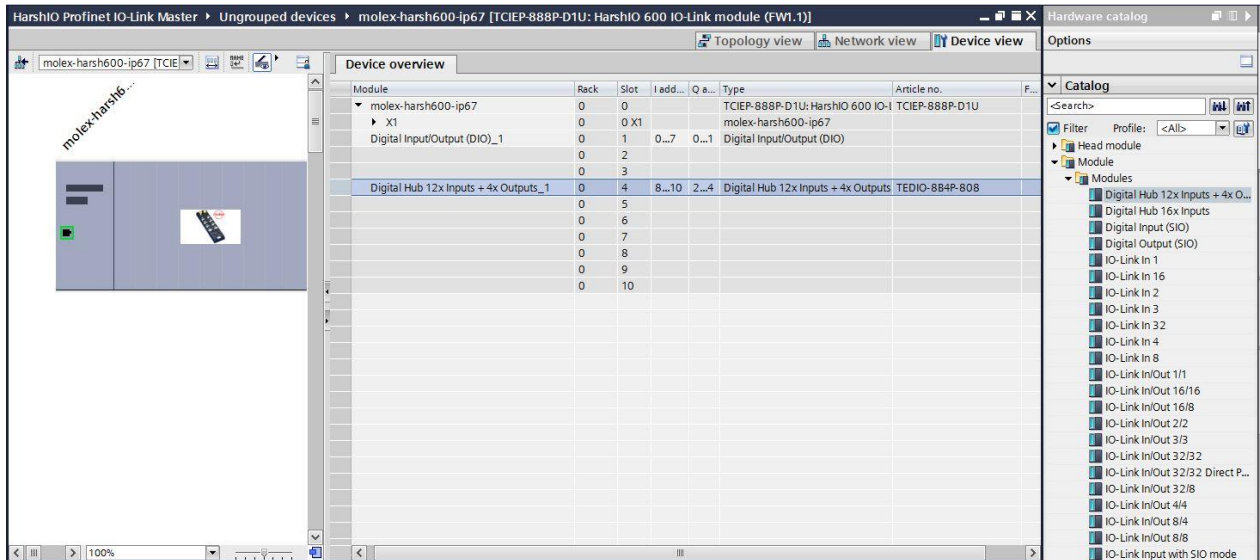

Hardware identifier:

Before starting to configure the IOL_LINK_DEVICE function block, you will need the value of “Hardware identifier” of the Digital Input/Output (DIO) standard module. It is needed to be entered in the input parameter of the IOL_LINK_DEVICE function block called “ID”.

To have the hardware identifier of the DIO module :

- 1) Select the Digital Input/Output (DIO) standard module
- 2) Go to “General” tab, select “Hardware identifier” and check the value to be used.

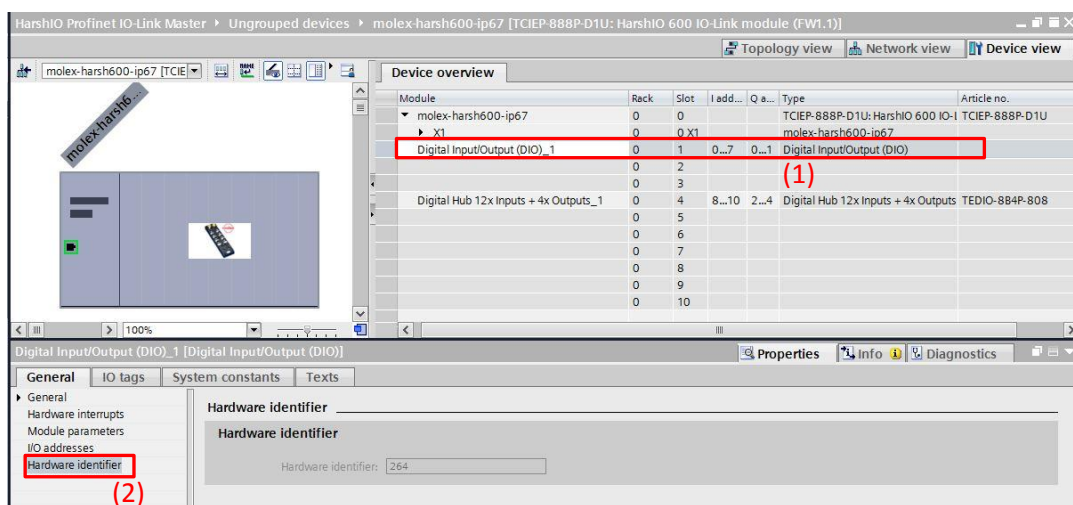

TECHNOTE

IOL-CALL Function block with HarhIO PROFINET IO-Link Master

Settings of the IO-Link function block:

For reading the vendor name of the Molex IO-Link device connected on the port 3 (channel 4) of the HarshIO, the settings of the IO-Link function block will be as follow:

Parameter	Description
ID	= 264 (Hardware identifier value)
CAP	= 255 (Molex access point)
RD_WR	= 0 (Read request)
PORT	= 4 (Channel number 4)
IOL_INDEX	= 16 (Index of vendor name further to the IO-Link device user's manual)
IOL_SUBINDEX	= 0 (Subindex of vendor name further to the IO-Link device user's manual)
LEN	= 0 (not important in case of read request)
RECORD_IOL_DATA	= Target area where the read data will be stored (an array of 232 bytes)

To do these settings in TIA Portal tool, a Data Block (DB) must be created and add all these parameters in this new data block as follow:

Name	Data type	Start value	Retain	Accessible f...	Writa...	Visible in ...	Setpoint	Supervision	Comment
1	Static								
2	Bool	false							
3	HW_IO	264							
4	Dint	255							
5	Bool	false							
6	Int	4							
7	Int	16							
8	Int	0							
9	Int	0							
10	Int	0							
11	Int	0							
12	Int	0							
13	Int	0							
14	Int	0							
15	Int	0							
16	Array[0..19]...								
17	<Add new>								

TECHNOTE

IOL-CALL Function block with HarhIO PROFINET IO-Link Master

Once done, you need to assign these parameters in the IO-Link function block in your program Main OB1.

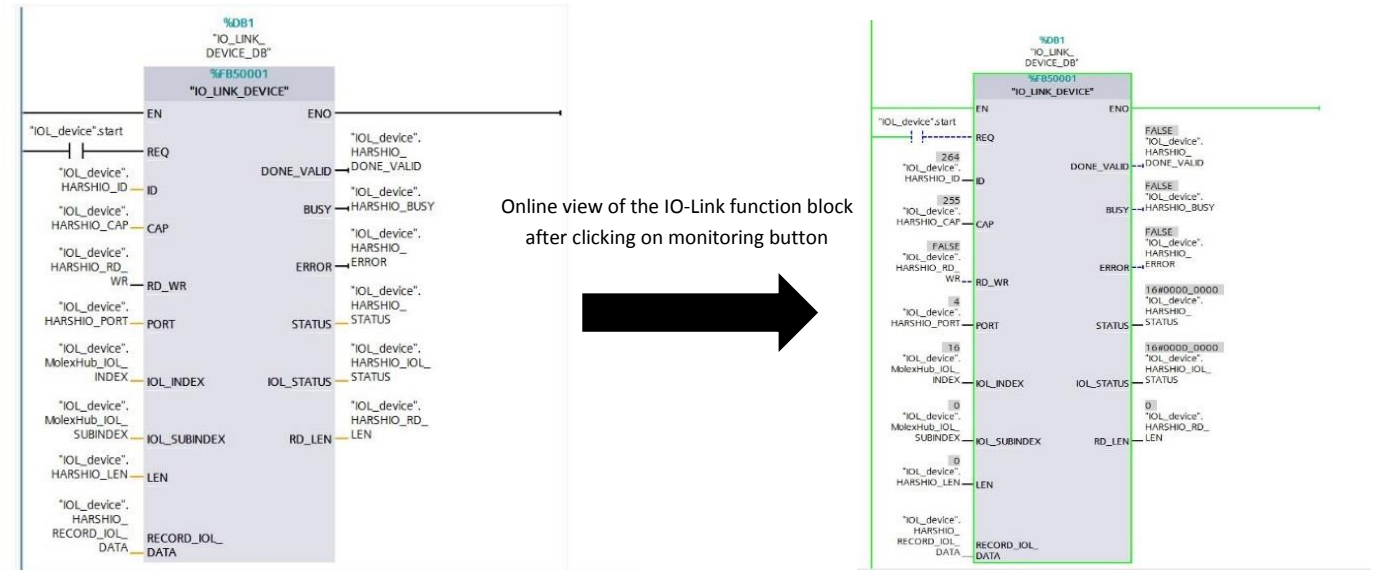

TECHNOTE

IOL-CALL Function block with HarhIO PROFINET IO-Link Master

The following figure shows an online view on the IO-Link data block that we have created for configuration the IO-Link function block.

The figure shows that all the values of the target area where the read data will be stored “HARSHIO_RECORD_IOL_DATA” have the value 0 because the read request via the IO-Link function block is not started yet.

HarshIO Profinet IO-Link Master > PLC_1 [CPU 1511F-1 PN] > Program blocks > IOL_device [DB2]										
Keep actual values Snapshot Copy snapshots to start values Load start values as actual values										
IOL_device										
Name	Data type	Start value	Monitor value	Retain	Accessible f...	Writa...	Visible in ...	Setpoint	Supervision	Comment
1	Static									
2	start	Bool	false	FALSE						
3	HARSHIO_ID	HW_IO	264	264						
4	HARSHIO_CAP	DInt	255	255						
5	HARSHIO_RD_WR	Bool	false	FALSE						
6	HARSHIO_PORT	Int	4	4						
7	MolexHub_IOL_INDEX	Int	16	16						
8	MolexHub_IOL_SUBINDEX	Int	0	0						
9	HARSHIO_LEN	Int	0	0						
10	HARSHIO_DONE_VALID	Bool	false	FALSE						
11	HARSHIO_BUSY	Bool	false	FALSE						
12	HARSHIO_ERROR	Bool	false	FALSE						
13	HARSHIO_STATUS	DWord	16#0	16#0000_0000						
14	HARSHIO_IOL_STATUS	DWord	16#0	16#0000_0000						
15	HARSHIO_RD_LEN	Int	0	0						
16	HARSHIO_RECORD_IOL_DATA	Array[0..23...]								
17	HARSHIO_RECORD_IOL_DAT	Byte	16#0	16#00						
18	HARSHIO_RECORD_IOL_DAT	Byte	16#0	16#00						
19	HARSHIO_RECORD_IOL_DAT	Byte	16#0	16#00						
20	HARSHIO_RECORD_IOL_DAT	Byte	16#0	16#00						
21	HARSHIO_RECORD_IOL_DAT	Byte	16#0	16#00						
22	HARSHIO_RECORD_IOL_DAT	Byte	16#0	16#00						
23	HARSHIO_RECORD_IOL_DAT	Byte	16#0	16#00						
24	HARSHIO_RECORD_IOL_DAT	Byte	16#0	16#00						
25	HARSHIO_RECORD_IOL_DAT	Byte	16#0	16#00						
26	HARSHIO_RECORD_IOL_DAT	Byte	16#0	16#00						
27	HARSHIO_RECORD_IOL_DAT	Byte	16#0	16#00						
28	HARSHIO_RECORD_IOL_DAT	Byte	16#0	16#00						
29	HARSHIO_RECORD_IOL_DAT	Byte	16#0	16#00						
30	HARSHIO_RECORD_IOL_DAT	Byte	16#0	16#00						
31	HARSHIO_RECORD_IOL_DAT	Byte	16#0	16#00						
32	HARSHIO_RECORD_IOL_DAT	Byte	16#0	16#00						
33	HARSHIO_RECORD_IOL_DAT	Byte	16#0	16#00						
34	HARSHIO_RECORD_IOL_DAT	Byte	16#0	16#00						
35	HARSHIO_RECORD_IOL_DAT	Byte	16#0	16#00						
36	HARSHIO_RECORD_IOL_DAT	Byte	16#0	16#00						
37	HARSHIO_RECORD_IOL_DAT	Byte	16#0	16#00						
38	HARSHIO_RECORD_IOL_DAT	Byte	16#0	16#00						
39	HARSHIO_RECORD_IOL_DAT	Byte	16#0	16#00						
40	HARSHIO_RECORD_IOL_DAT	Byte	16#0	16#00						
41	HARSHIO_RECORD_IOL_DAT	Byte	16#0	16#00						
42	HARSHIO_RECORD_IOL_DAT	Byte	16#0	16#00						
43	HARSHIO_RECORD_IOL_DAT	Byte	16#0	16#00						
44	HARSHIO_RECORD_IOL_DAT	Byte	16#0	16#00						
45	HARSHIO_RECORD_IOL_DAT	Byte	16#0	16#00						
46	HARSHIO_RECORD_IOL_DAT	Byte	16#0	16#00						
47	HARSHIO_RECORD_IOL_DAT	Byte	16#0	16#00						
48	HARSHIO_RECORD_IOL_DAT	Byte	16#0	16#00						

TECHNOTE

IOL-CALL Function block with HarhIO PROFINET IO-Link Master

After sending the read request via the function block by activating the bit that put the “REQ” parameter on, the values of outputs parameters have changed:

- DONE_VALID : this value has switched from false to true meaning that this operation is finished and that it is valid.
- BUSY: this value is false because the function block has finished the read. This value is true only during the read operation.
- ERROR: this value is false because there was no error during the read request sent by the IO-Link function block
- STATUS: the value is 16#0000_0000 meaning there was no communication error status, everything is good.
- IOL_STATUS: the value is 16#0000_0000 meaning there was no IO-Link error status, everything is good.
- LEN: this value is 9 because the function block has read 9 bytes from the IO-Link device connected physically on the requested IO-Link channel (channel 4). The 9 bytes represent the value of the vendor name that was read.

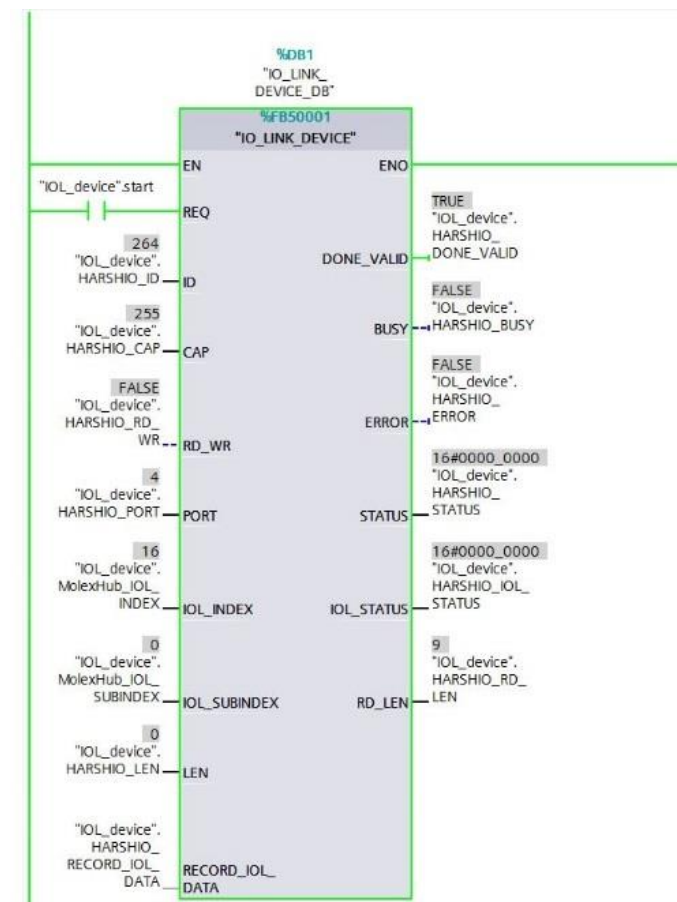

TECHNOTE

IOL-CALL Function block with HarhIO PROFINET IO-Link Master

The following figure shows the new values stored “HARSHIO_RECORD_IOL_DATA”

Name	Data type	Start value	Monitor value	Retain	Accessible f...	Writa...	Visible in ...	Setpoint	Supervision	Comment
Static										
start	Bool	false	TRUE	<input type="checkbox"/>	<input checked="" type="checkbox"/>	<input checked="" type="checkbox"/>	<input checked="" type="checkbox"/>	<input type="checkbox"/>		
HARSHIO_ID	HW_IO	264	264	<input type="checkbox"/>	<input checked="" type="checkbox"/>	<input checked="" type="checkbox"/>	<input checked="" type="checkbox"/>	<input type="checkbox"/>		
HARSHIO_CAP	DInt	255	255	<input type="checkbox"/>	<input checked="" type="checkbox"/>	<input checked="" type="checkbox"/>	<input checked="" type="checkbox"/>	<input type="checkbox"/>		
HARSHIO_RD_WR	Bool	false	FALSE	<input type="checkbox"/>	<input checked="" type="checkbox"/>	<input checked="" type="checkbox"/>	<input checked="" type="checkbox"/>	<input type="checkbox"/>		
HARSHIO_PORT	Int	4	4	<input type="checkbox"/>	<input checked="" type="checkbox"/>	<input checked="" type="checkbox"/>	<input checked="" type="checkbox"/>	<input type="checkbox"/>		
MolexHub_IOL_INDEX	Int	16	16	<input type="checkbox"/>	<input checked="" type="checkbox"/>	<input checked="" type="checkbox"/>	<input checked="" type="checkbox"/>	<input type="checkbox"/>		
MolexHub_IOL_SUBINDEX	Int	0	0	<input type="checkbox"/>	<input checked="" type="checkbox"/>	<input checked="" type="checkbox"/>	<input checked="" type="checkbox"/>	<input type="checkbox"/>		
HARSHIO_LEN	Int	0	0	<input type="checkbox"/>	<input checked="" type="checkbox"/>	<input checked="" type="checkbox"/>	<input checked="" type="checkbox"/>	<input type="checkbox"/>		
HARSHIO_DONE_VALID	Bool	false	TRUE	<input type="checkbox"/>	<input checked="" type="checkbox"/>	<input checked="" type="checkbox"/>	<input checked="" type="checkbox"/>	<input type="checkbox"/>		
HARSHIO_BUSY	Bool	false	FALSE	<input type="checkbox"/>	<input checked="" type="checkbox"/>	<input checked="" type="checkbox"/>	<input checked="" type="checkbox"/>	<input type="checkbox"/>		
HARSHIO_ERROR	Bool	false	FALSE	<input type="checkbox"/>	<input checked="" type="checkbox"/>	<input checked="" type="checkbox"/>	<input checked="" type="checkbox"/>	<input type="checkbox"/>		
HARSHIO_STATUS	DWord	16#0	16#0000_0000	<input type="checkbox"/>	<input checked="" type="checkbox"/>	<input checked="" type="checkbox"/>	<input checked="" type="checkbox"/>	<input type="checkbox"/>		
HARSHIO_IOL_STATUS	DWord	16#0	16#0000_0000	<input type="checkbox"/>	<input checked="" type="checkbox"/>	<input checked="" type="checkbox"/>	<input checked="" type="checkbox"/>	<input type="checkbox"/>		
HARSHIO_RD_LEN	Int	0	9	<input type="checkbox"/>	<input checked="" type="checkbox"/>	<input checked="" type="checkbox"/>	<input checked="" type="checkbox"/>	<input type="checkbox"/>		
HARSHIO_RECORD_IOL_DATA	Array[0..231] of Byte			<input type="checkbox"/>	<input checked="" type="checkbox"/>	<input checked="" type="checkbox"/>	<input checked="" type="checkbox"/>	<input type="checkbox"/>		
HARSHIO_RECORD_IOL_DAT	Byte	16#0	16#4D	<input type="checkbox"/>	<input checked="" type="checkbox"/>	<input checked="" type="checkbox"/>	<input checked="" type="checkbox"/>	<input type="checkbox"/>		
HARSHIO_RECORD_IOL_DAT	Byte	16#0	16#6F	<input type="checkbox"/>	<input checked="" type="checkbox"/>	<input checked="" type="checkbox"/>	<input checked="" type="checkbox"/>	<input type="checkbox"/>		
HARSHIO_RECORD_IOL_DAT	Byte	16#0	16#6C	<input type="checkbox"/>	<input checked="" type="checkbox"/>	<input checked="" type="checkbox"/>	<input checked="" type="checkbox"/>	<input type="checkbox"/>		
HARSHIO_RECORD_IOL_DAT	Byte	16#0	16#65	<input type="checkbox"/>	<input checked="" type="checkbox"/>	<input checked="" type="checkbox"/>	<input checked="" type="checkbox"/>	<input type="checkbox"/>		
HARSHIO_RECORD_IOL_DAT	Byte	16#0	16#78	<input type="checkbox"/>	<input checked="" type="checkbox"/>	<input checked="" type="checkbox"/>	<input checked="" type="checkbox"/>	<input type="checkbox"/>		
HARSHIO_RECORD_IOL_DAT	Byte	16#0	16#20	<input type="checkbox"/>	<input checked="" type="checkbox"/>	<input checked="" type="checkbox"/>	<input checked="" type="checkbox"/>	<input type="checkbox"/>		
HARSHIO_RECORD_IOL_DAT	Byte	16#0	16#49	<input type="checkbox"/>	<input checked="" type="checkbox"/>	<input checked="" type="checkbox"/>	<input checked="" type="checkbox"/>	<input type="checkbox"/>		
HARSHIO_RECORD_IOL_DAT	Byte	16#0	16#6E	<input type="checkbox"/>	<input checked="" type="checkbox"/>	<input checked="" type="checkbox"/>	<input checked="" type="checkbox"/>	<input type="checkbox"/>		
HARSHIO_RECORD_IOL_DAT	Byte	16#0	16#63	<input type="checkbox"/>	<input checked="" type="checkbox"/>	<input checked="" type="checkbox"/>	<input checked="" type="checkbox"/>	<input type="checkbox"/>		
HARSHIO_RECORD_IOL_DAT	Byte	16#0	16#00	<input type="checkbox"/>	<input checked="" type="checkbox"/>	<input checked="" type="checkbox"/>	<input checked="" type="checkbox"/>	<input type="checkbox"/>		
HARSHIO_RECORD_IOL_DAT	Byte	16#0	16#00	<input type="checkbox"/>	<input checked="" type="checkbox"/>	<input checked="" type="checkbox"/>	<input checked="" type="checkbox"/>	<input type="checkbox"/>		
HARSHIO_RECORD_IOL_DAT	Byte	16#0	16#00	<input type="checkbox"/>	<input checked="" type="checkbox"/>	<input checked="" type="checkbox"/>	<input checked="" type="checkbox"/>	<input type="checkbox"/>		
HARSHIO_RECORD_IOL_DAT	Byte	16#0	16#00	<input type="checkbox"/>	<input checked="" type="checkbox"/>	<input checked="" type="checkbox"/>	<input checked="" type="checkbox"/>	<input type="checkbox"/>		
HARSHIO_RECORD_IOL_DAT	Byte	16#0	16#00	<input type="checkbox"/>	<input checked="" type="checkbox"/>	<input checked="" type="checkbox"/>	<input checked="" type="checkbox"/>	<input type="checkbox"/>		
HARSHIO_RECORD_IOL_DAT	Byte	16#0	16#00	<input type="checkbox"/>	<input checked="" type="checkbox"/>	<input checked="" type="checkbox"/>	<input checked="" type="checkbox"/>	<input type="checkbox"/>		
HARSHIO_RECORD_IOL_DAT	Byte	16#0	16#00	<input type="checkbox"/>	<input checked="" type="checkbox"/>	<input checked="" type="checkbox"/>	<input checked="" type="checkbox"/>	<input type="checkbox"/>		
HARSHIO_RECORD_IOL_DAT	Byte	16#0	16#00	<input type="checkbox"/>	<input checked="" type="checkbox"/>	<input checked="" type="checkbox"/>	<input checked="" type="checkbox"/>	<input type="checkbox"/>		
HARSHIO_RECORD_IOL_DAT	Byte	16#0	16#00	<input type="checkbox"/>	<input checked="" type="checkbox"/>	<input checked="" type="checkbox"/>	<input checked="" type="checkbox"/>	<input type="checkbox"/>		
HARSHIO_RECORD_IOL_DAT	Byte	16#0	16#00	<input type="checkbox"/>	<input checked="" type="checkbox"/>	<input checked="" type="checkbox"/>	<input checked="" type="checkbox"/>	<input type="checkbox"/>		
HARSHIO_RECORD_IOL_DAT	Byte	16#0	16#00	<input type="checkbox"/>	<input checked="" type="checkbox"/>	<input checked="" type="checkbox"/>	<input checked="" type="checkbox"/>	<input type="checkbox"/>		
HARSHIO_RECORD_IOL_DAT	Byte	16#0	16#00	<input type="checkbox"/>	<input checked="" type="checkbox"/>	<input checked="" type="checkbox"/>	<input checked="" type="checkbox"/>	<input type="checkbox"/>		
HARSHIO_RECORD_IOL_DAT	Byte	16#0	16#00	<input type="checkbox"/>	<input checked="" type="checkbox"/>	<input checked="" type="checkbox"/>	<input checked="" type="checkbox"/>	<input type="checkbox"/>		
HARSHIO_RECORD_IOL_DAT	Byte	16#0	16#00	<input type="checkbox"/>	<input checked="" type="checkbox"/>	<input checked="" type="checkbox"/>	<input checked="" type="checkbox"/>	<input type="checkbox"/>		
HARSHIO_RECORD_IOL_DAT	Byte	16#0	16#00	<input type="checkbox"/>	<input checked="" type="checkbox"/>	<input checked="" type="checkbox"/>	<input checked="" type="checkbox"/>	<input type="checkbox"/>		
HARSHIO_RECORD_IOL_DAT	Byte	16#0	16#00	<input type="checkbox"/>	<input checked="" type="checkbox"/>	<input checked="" type="checkbox"/>	<input checked="" type="checkbox"/>	<input type="checkbox"/>		
HARSHIO_RECORD_IOL_DAT	Byte	16#0	16#00	<input type="checkbox"/>	<input checked="" type="checkbox"/>	<input checked="" type="checkbox"/>	<input checked="" type="checkbox"/>	<input type="checkbox"/>		
HARSHIO_RECORD_IOL_DAT	Byte	16#0	16#00	<input type="checkbox"/>	<input checked="" type="checkbox"/>	<input checked="" type="checkbox"/>	<input checked="" type="checkbox"/>	<input type="checkbox"/>		
HARSHIO_RECORD_IOL_DAT	Byte	16#0	16#00	<input type="checkbox"/>	<input checked="" type="checkbox"/>	<input checked="" type="checkbox"/>	<input checked="" type="checkbox"/>	<input type="checkbox"/>		
HARSHIO_RECORD_IOL_DAT	Byte	16#0	16#00	<input type="checkbox"/>	<input checked="" type="checkbox"/>	<input checked="" type="checkbox"/>	<input checked="" type="checkbox"/>	<input type="checkbox"/>		

If these new values stored in “HARSHIO_RECORD_IOL_DATA” are converted from HEX to ASCII, the result is “Molex Inc”

TECHNOTE

IOL-CALL Function block with HarhIO PROFINET IO-Link Master

b. Data Storage backup by ISDU access using IOL_CALL.

The data storage backup mechanism allows to upgrade the parameters related to the IO-Link device in the DS file. The user can use this mechanism after modifying some parameters in the IO-Link device.

There are 3 ways to send a Data Storage backup request:

- Using any IO-Link Tool of the Market
- Using the “Force DS File backup” using Status And Control module (please refer to the HarshIO PROFINET IO-Link Master user’s manual).
- Using ISDU access

Data Storage backup using ISDU access.

For a Data Storage backup using ISDU access, the use of the IOL_CALL function block is needed. It is mandatory in this mode to enable the Data Storage backup in the configuration of the module related to the IO-Link Device in TIA Portal Hardware configuration. It is done by configuring the Channel mode of the module as “Compatible device with Backup + Restore” or “Identical device with Backup + Restore”

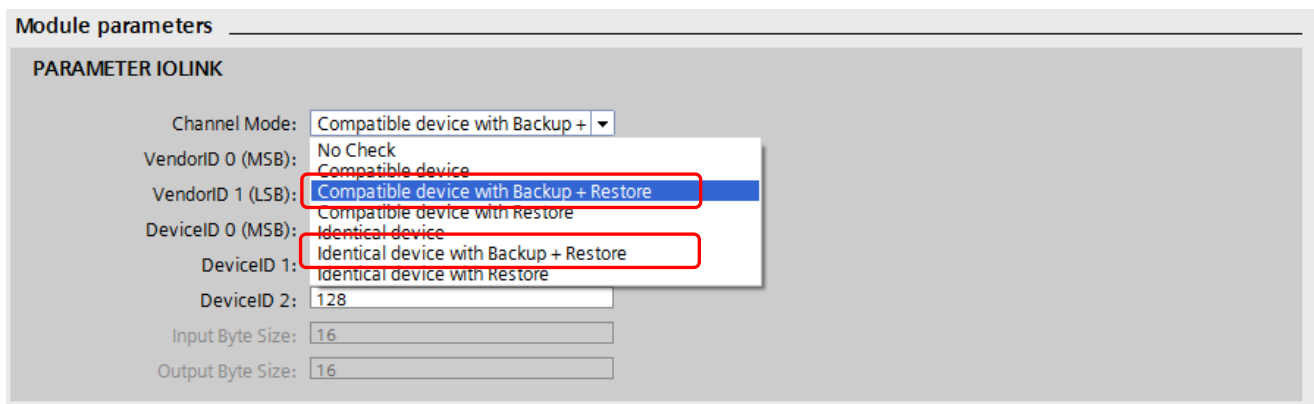

As the Data Storage backup is useful only if the user modifies the online IO-Link parameters of the IO-Link device, the user will need to use the IOL_CALL function block following 2 steps:

- Step 1: Modifying online IO-Link parameter by doing a write ISDU parameters via IOL_CALL
- Step 2: DS upload request:
Asking the IO-Link device to inform the IO-Link Master that the parameters have been changed and that a DS File update must be done.

The user uses a System command for asking the IO-Link device to send this request by doing an IOL_CALL ISDU write request to the specific Index of the IO-Link device, this write will trigger the send of DS File upload request by the IO-Link device.

This System command ISDU index is 0x0002 and the command value for finalizing parametrization and starting Data Storage is 0x05 (command name: ParamDownloadStore).

TECHNOTE

IOL-CALL Function block with HarshIO PROFINET IO-Link Master

For sending this System command to the specific ISDU Index, we will need to use the IOL_CALL block. The IOL_CALL function must have the following values:

- Index: 2
- Sub Index: 0
- Length: 1
- Value: 0x05

Example of Data Storage backup using ISDU access.

In this example project, we will use the IO-Link function block IOL_CALL (IOL_LINK_DEVICE) for modifying the online IO-Link parameter in the IO-Link device and for asking the IO-Link device to send the DS File upload request to the IO-Link Master.

Used hardware:

- Siemens S7, CPU 1511F-1 PN (Firmware v2.0)
- Molex IO-Link Digital Hub 12x inputs/4x outputs TEDIO-8B4P-808 (Product Version 1.0.0.0 or upper)
- Molex HarshIO Profinet IO-Link Master (Product Version 1.0.0.0 or upper)

Used Software:

- Siemens Totally Integrated Automation Portal v14

Step 1: modifying online parameters in IO-Link device

In this example, the IO-Link device “Molex IO-Link Digital Hub 12x inputs/4x outputs” will be connected physically on the port 0 (channel 0) of the Molex HarshIO Profinet IO-Link Master. For doing this configuration in the hardware configuration in TIA Portal tool, you need to drag and drop the IO-Link device module named “Digital Hub 12x Inputs + 4x Outputs” from Catalog to the port 0 of the HarshIO. As example of online parameters modification in the IO-Link device, we will modify the parameter “Input Filter” of some channels of the Molex Hub IO-Link device by changing their configuration from “Input not inverted” to “Input inverted”.

The configuration of this Molex Hub IO-Link device parameter is available via the Index 0x41 (65 dec) / Sub Index 0 (information can be obtained from the user’s manual of the IO-Link device).

For each channel of the IO-Link device, the value 0 means that the input is not inverted and the value 1 means that the input is inverted. By default, the value of this Index is 0x0000 meaning that all the inputs are not inverted by default.

In this example, we will send a ISDU write request for changing the values of this Index from 0x0000 to 0x1111.

TECHNOTE

IOL-CALL Function block with HarhIO PROFINET IO-Link Master

Settings of the IO-Link function block:

For modifying the “Input Filter” parameters of this Index, the settings of the IO-Link function block will be as follow:

Parameter	Description
ID	= 264 (Hardware identifier value)
CAP	= 255 (Molex access point)
RD_WR	= 1 (Write request)
PORT	= 0 (Channel number 0)
IOL_INDEX	= 65 (Index of “Input filter” parameter of Molex Hub IO-Link device)
IOL_SUBINDEX	= 0 (Subindex of “Input filter” parameter of Molex Hub IO-Link device)
LEN	= 2 (write of the value 0x1111 that represents 2 bytes)
RECORD_IOL_DATA	= Target area where we put the value 0x1111 that will be written

This figure shows the values assigned to the IOL_CALL function block:

- ID = 264
- CAP = 255
- RD_WR = 1
- PORT = 0
- INDEX = 65
- SUBINDEX = 0
- LEN = 2

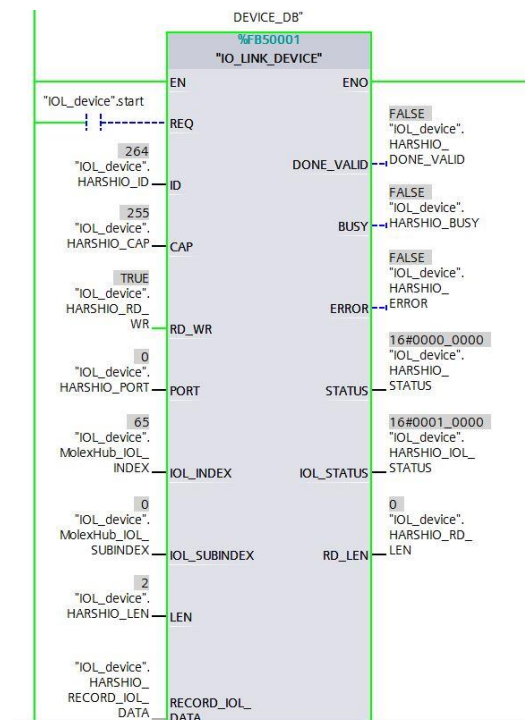

Once the request is activated (“IOL_device”.start = TRUE), the IOL_CALL function block will start the request to write the value 0x1111 in the appropriate Index 65 of the Molex Hub IO-Link device

TECHNOTE

IOL-CALL Function block with HarhIO PROFINET IO-Link Master

Step 2: DS File upload request

After that the Input filter parameters of some channels are changed in the IO-Link device, we need to update these parameters in the IO-Link Device Data Storage file located in the IO-Link Master by doing a DS File upload.

As explained previously, to activate the DS File backup (upload) from the IO-Link device, the user needs to send a System command ISDU write request using the IOL_CALL function with the following values:

- Index: 2
- Sub Index: 0
- Length: 1
- Value: 0x05

Settings of the IO-Link function block :

For asking the IO-Link device to send the DS File upload request, the settings of the IO-Link function block will be as follow:

Parameter	Description
ID	= 264 (Hardware identifier value)
CAP	= 255 (Molex access point)
RD_WR	= 1 (Write request)
PORT	= 0 (Channel number 0)
IOL_INDEX	= 2 (Index for requesting DS file upload)
IOL_SUBINDEX	= 0 (Subindex for requesting DS file upload)
LEN	= 1 (write of the value 0x05 that represents 1 bytes)
RECORD_IOL_DATA	= Target area where we put the value 0x05 that will be written

The following figure shows the values assigned to the IOL_CALL function block in this example as defined in the previous settings:

Name	Data type	Start value	Retain	Accessible f...	Writa...	Visible in ...	Setpoint	...
1	Static							
2	start	Bool	false	<input type="checkbox"/>	<input checked="" type="checkbox"/>	<input checked="" type="checkbox"/>	<input type="checkbox"/>	
3	HARSHIO_ID	HW_IO	264	<input type="checkbox"/>	<input checked="" type="checkbox"/>	<input checked="" type="checkbox"/>	<input checked="" type="checkbox"/>	
4	HARSHIO_CAP	DInt	255	<input type="checkbox"/>	<input checked="" type="checkbox"/>	<input checked="" type="checkbox"/>	<input checked="" type="checkbox"/>	
5	HARSHIO_RD_WR	Bool	1	<input type="checkbox"/>	<input checked="" type="checkbox"/>	<input checked="" type="checkbox"/>	<input type="checkbox"/>	
6	HARSHIO_PORT	Int	0	<input type="checkbox"/>	<input checked="" type="checkbox"/>	<input checked="" type="checkbox"/>	<input checked="" type="checkbox"/>	
7	MolexHub_IOL_INDEX	Int	2	<input type="checkbox"/>	<input checked="" type="checkbox"/>	<input checked="" type="checkbox"/>	<input type="checkbox"/>	
8	MolexHub_IOL_SUBINDEX	Int	0	<input type="checkbox"/>	<input checked="" type="checkbox"/>	<input checked="" type="checkbox"/>	<input type="checkbox"/>	
9	HARSHIO_LEN	Int	1	<input type="checkbox"/>	<input checked="" type="checkbox"/>	<input checked="" type="checkbox"/>	<input type="checkbox"/>	
10	HARSHIO_DONE_VALID	Bool	false	<input type="checkbox"/>	<input checked="" type="checkbox"/>	<input checked="" type="checkbox"/>	<input checked="" type="checkbox"/>	
11	HARSHIO_BUSY	Bool	false	<input type="checkbox"/>	<input checked="" type="checkbox"/>	<input checked="" type="checkbox"/>	<input type="checkbox"/>	
12	HARSHIO_ERROR	Bool	false	<input type="checkbox"/>	<input checked="" type="checkbox"/>	<input checked="" type="checkbox"/>	<input checked="" type="checkbox"/>	
13	HARSHIO_STATUS	DWord	16#0	<input type="checkbox"/>	<input checked="" type="checkbox"/>	<input checked="" type="checkbox"/>	<input checked="" type="checkbox"/>	
14	HARSHIO_IOL_STATUS	DWord	16#0	<input type="checkbox"/>	<input checked="" type="checkbox"/>	<input checked="" type="checkbox"/>	<input type="checkbox"/>	
15	HARSHIO_RD_LEN	Int	0	<input type="checkbox"/>	<input checked="" type="checkbox"/>	<input checked="" type="checkbox"/>	<input checked="" type="checkbox"/>	
16	HARSHIO_RECORD_IOL_DATA	Array(0..231) of Byte		<input type="checkbox"/>	<input checked="" type="checkbox"/>	<input checked="" type="checkbox"/>	<input type="checkbox"/>	
17	HARSHIO_RECORD_IOL_DATA[0]	Byte	16#05	<input type="checkbox"/>	<input checked="" type="checkbox"/>	<input checked="" type="checkbox"/>	<input type="checkbox"/>	
18	HARSHIO_RECORD_IOL_DATA[1]	Byte	16#0	<input type="checkbox"/>	<input checked="" type="checkbox"/>	<input checked="" type="checkbox"/>	<input type="checkbox"/>	
19	HARSHIO_RECORD_IOL_DATA[2]	Byte	16#0	<input type="checkbox"/>	<input checked="" type="checkbox"/>	<input checked="" type="checkbox"/>	<input type="checkbox"/>	
20	HARSHIO_RECORD_IOL_DATA[3]	Byte	16#0	<input type="checkbox"/>	<input checked="" type="checkbox"/>	<input checked="" type="checkbox"/>	<input type="checkbox"/>	
21	HARSHIO_RECORD_IOL_DATA[4]	Byte	16#0	<input type="checkbox"/>	<input checked="" type="checkbox"/>	<input checked="" type="checkbox"/>	<input type="checkbox"/>	
22	HARSHIO_RECORD_IOL_DATA[5]	Byte	16#0	<input type="checkbox"/>	<input checked="" type="checkbox"/>	<input checked="" type="checkbox"/>	<input type="checkbox"/>	
23	HARSHIO_RECORD_IOL_DATA[6]	Byte	16#0	<input type="checkbox"/>	<input checked="" type="checkbox"/>	<input checked="" type="checkbox"/>	<input type="checkbox"/>	

TECHNOTE

IOL-CALL Function block with HarhIO PROFINET IO-Link Master

Once the request is activated ("IOL_device".start = TRUE), the IOL_CALL function block will start the request to write the value 0x05 in the appropriate Index 2 of the Molex Hub IO-Link device.

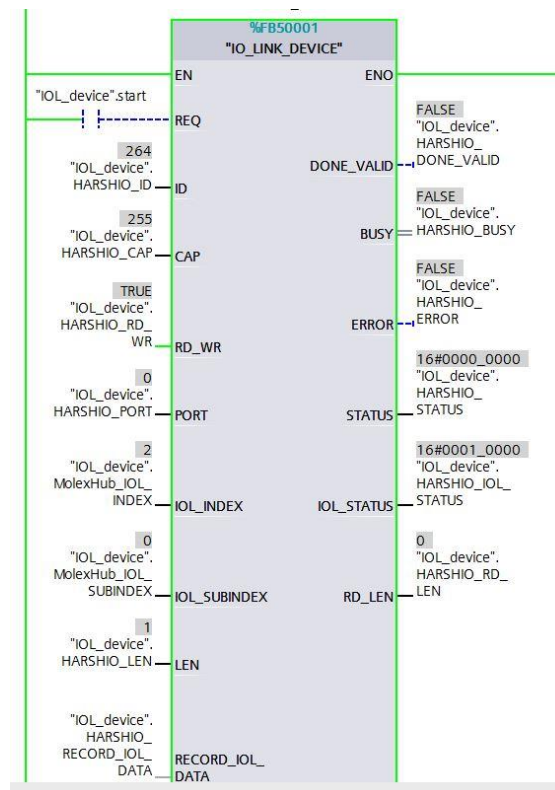

In this example, you can check that the DS File has been modified with the new values of Input Filter by doing a ISDU read request to the Index 65 / Sub Index 0, normally in the DS File the values must be 0x1111 instead of 0x0000 confirming that the DS File backup was done successfully and that these values are updated in the Data Storage file.