

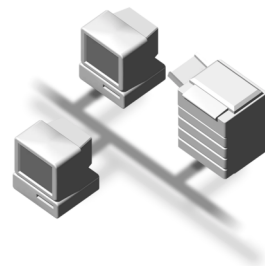

Network Guide



-
- 1 Functions Available over a Network
 - 2 Connecting the Network Cable to the Network
 - 3 Setting Up the Machine on a Network
 - 4 Windows Configuration
 - 5 Using the Printer Function
 - 6 Using SmartDeviceMonitor for Client
 - 7 Using SmartDeviceMonitor for Admin
 - 8 Configuring the Network Interface Board Using a Web Browser
 - 9 Appendix

Read this manual carefully before you use this machine and keep it handy for future reference. For safe and correct use, be sure to read the Safety Information in the "Copy Reference" before using the machine.

Introduction

This manual contains detailed instructions and notes on the operation and use of this machine. For your safety and benefit, read this manual carefully before using the machine. Keep this manual in a handy place for quick reference.

Important

Contents of this manual are subject to change without prior notice. In no event will the company be liable for direct, indirect, special, incidental, or consequential damages as a result of handling or operating the machine.

Software Version Conventions Used in This Manual

- NetWare 3.x means NetWare 3.12 and 3.2.
- NetWare 4.x means NetWare 4.1, 4.11, 4.2 and IntranetWare.

Two kinds of size notation are employed in this manual. With this machine refer to the metric version.

Trademarks

Microsoft®, Windows® and Windows NT® are registered trademarks of Microsoft Corporation in the United States and/or other countries.

Apple, AppleTalk, EtherTalk, Macintosh, Mac OS and TrueType are trademarks of Apple Computer, Inc, registered in the United States and other countries. Rendezvous is a trademark of Apple Computer Inc. Netscape and Netscape Navigator are registered trademarks of Netscape Communications Corporation. Novell, NetWare, NDS and NDPS are registered trademarks of Novell, Inc.

PostScript® and Acrobat® are registered trademarks of Adobe Systems, Incorporated.

UNIX is a registered trademark in the United States and other countries, licensed exclusively through X/Open Company Limited.

Citrix® and MetaFrame® are registered trademarks of Citrix Systems, Inc.

UPnP is a trademark of the UPnP Implementers Corporation.

Other product names used herein are for identification purposes only and might be trademarks of their respective companies. We disclaim any and all rights in those marks.

The proper names of the Windows operating systems are as follows:

- The product name of Windows® 95 is Microsoft® Windows 95.
- The product name of Windows® 98 is Microsoft® Windows 98.
- The product name of Windows® Me is Microsoft® Windows Millennium Edition (Windows Me).
- The product names of Windows® 2000 are as follows:
Microsoft® Windows® 2000 Advanced Server
Microsoft® Windows® 2000 Server
Microsoft® Windows® 2000 Professional
- The product names of Windows® XP are as follows:
Microsoft® Windows® XP Professional
Microsoft® Windows® XP Home Edition
- The product names of Windows™ Server 2003 are as follows:
Microsoft® Windows™ Server 2003 Standard Edition
Microsoft® Windows™ Server 2003 Enterprise Edition
Microsoft® Windows™ Server 2003 Web Edition
- The product names of Windows NT® 4.0 are as follows:
Microsoft® Windows NT® Server 4.0
Microsoft® Windows NT® Workstation 4.0
- RSA Data Security, Inc. MD5 Message-Digest Algorithm
Copyright© 1991-2, RSA Data Security, Inc. Created 1991. All rights reserved.
License to copy and use this software is granted provided that it is identified as the "RSA Data Security, Inc. MD5 Message-Digest Algorithm" in all material mentioning or referencing this software or this function.
License is also granted to make and use derivative works provided that such works are identified as "derived from the RSA Data Security, Inc. MD5 Message-Digest Algorithm" in all material mentioning or referencing the derived work.
RSA Data Security, Inc. makes no representations concerning either the merchantability of this software or the suitability of this software for any particular purpose. It is provided "as is" without express or implied warranty of any kind.
These notices must be retained in any copies of any part of this documentation and/or software.

Note:

Some illustrations in this manual might be slightly different from the machine.

Manuals for This Machine

The following manuals describe the operational procedures of this machine. For particular functions, see the relevant parts of the manual.

Note

- Manuals provided are specific to machine type.
- Adobe Acrobat Reader is necessary to view the manuals as a PDF file.
- Three CD-ROMs are provided:
 - CD-ROM 1 “Operating Instructions for Printer/Scanner”
 - CD-ROM 2 “Scanner Driver & Document Management Utilities”
 - CD-ROM 3 “Operating Instructions for General Settings and Facsimile”

❖ **General Settings Guide (PDF file - CD-ROM3)***

Provides an overview of the machine and describes System Settings (paper trays, Key Operator Tools, etc.) and troubleshooting.

Refer to this manual for Address Book procedures such as registering fax numbers, e-mail addresses, and user codes.

❖ **Network Guide (PDF file - CD-ROM1) (this manual)**

Describes procedures for configuring the machine and computers in a network environment.

❖ **Copy Reference**

Describes operations, functions, and troubleshooting for the machine’s copier function.

❖ **Facsimile Reference <Basic Features>**

Describes operations, functions, and troubleshooting for the machine’s facsimile function.

❖ **Facsimile Reference <Advanced Features> (PDF file - CD-ROM3)***

Describes advanced functions and settings for key operators.

❖ **Printer Reference 1**

Describes system settings and operations for the machine’s printer function.

❖ **Printer Reference 2 (PDF file - CD-ROM1)**

Describes operations, functions, and troubleshooting for the machine’s printer function.

❖ **Scanner Reference (PDF file - CD-ROM1)**

Describes operations, functions, and troubleshooting for the machine’s scanner function.

❖ **Manuals for DeskTopBinder Lite**

DeskTopBinder Lite is a utility included on the CD-ROM labeled “Scanner Driver & Document Management Utilities”.

- DeskTopBinder Lite Setup Guide (PDF file - CD-ROM2)
Describes installation of, and the operating environment for DeskTopBinder Lite in detail. This guide can be displayed from the **[Setup]** dialog box when DeskTopBinder Lite is installed.
- DeskTopBinder Lite Introduction Guide (PDF file - CD-ROM2)
Describes operations of DeskTopBinder Lite and provides an overview of its functions. This guide is added to the **[Start]** menu when DeskTopBinder Lite is installed.
- Auto Document Link Guide (PDF file - CD-ROM2)
Describes operations and functions of Auto Document Link installed with DeskTopBinder Lite. This guide is added to the **[Start]** menu when DeskTopBinder Lite is installed.

❖ **Manuals for ScanRouter V2 Lite**

ScanRouter V2 Lite is a utility included on the CD-ROM labeled “Scanner Driver & Document Management Utilities”.

- ScanRouter V2 Lite Setup Guide (PDF file - CD-ROM2)
Describes installation of, settings, and the operating environment for ScanRouter V2 Lite in detail. This guide can be displayed from the **[Setup]** dialog box when ScanRouter V2 Lite is installed.
- ScanRouter V2 Lite Management Guide (PDF file - CD-ROM2)
Describes delivery server management and operations, and provides an overview of ScanRouter V2 Lite functions. This guide is added to the **[Start]** menu when ScanRouter V2 Lite is installed.

❖ **Other manuals**

- PostScript 3 Supplement (PDF file - CD-ROM1)
- UNIX Supplement (available from an authorized dealer, or as a PDF file on our Web site)

*Europe only

TABLE OF CONTENTS

Manuals for This Machine	i
How to Read This Manual	1

1. Functions Available over a Network

Using the Printer	3
Using Fax	4
Internet Fax	4
LAN-Fax	5
Network Scanner	6
E-mail	6
Network Delivery Scanner	7
Network TWAIN Scanner	8

2. Connecting the Network Cable to the Network

Confirming the Connection	9
Connecting to the Ethernet Interface	10
Connecting to the IEEE 1394 Interface	11
Using the IEEE 802.11b (Wireless LAN)	11

3. Setting Up the Machine on a Network

User Tools Menu (System Settings)	13
Printer (LAN-Fax)	13
Internet Fax	15
E-mail	18
Network Delivery Scanner	20
Network TWAIN Scanner	22
Network Configuration	23
Settings You Can Change with User Tools	26

4. Windows Configuration

Configuring TCP/IP	35
Configuring a Windows 95/98/Me Computer	35
Configuring a Windows 2000 Computer	35
Configuring a Windows XP Computer	36
Configuring a Windows Server 2003 computer	36
Configuring a Windows NT 4.0 Computer	37
Configuring NetBEUI	38
Configuring a Windows 95/98/Me Computer	38
Configuring a Windows 2000 Computer	38
Configuring a Windows NT 4.0 Computer	39

5. Using the Printer Function

Printing with Windows	45
Printing with a Windows 2000/XP, Windows Server 2003 or Windows NT 4.0 Print Server ...	45
Printing without a Print Server.....	46
Printing with a Macintosh	49
Changing to EtherTalk	49
Configuring the Printer	50
Changing the Printer Name.....	50
Changing the Zone.....	50
Printing with NetWare.....	51
Setting Up as a Print Server.....	52
Setting Up as a Remote Printer	56
Setting Up a Client Computer	60

6. Using SmartDeviceMonitor for Client

SmartDeviceMonitor for Client	63
--	-----------

7. Using SmartDeviceMonitor for Admin

SmartDeviceMonitor for Admin	67
Changing the Network Interface Board Configuration.....	69
Displaying Machine Status.....	69
Locking the Control Panel Menu	70
Selecting the Paper Type.....	70
Managing User Information.....	71
Loading Fax Journal.....	71
Managing Address Information	72
Configuring Energy Saver Mode	72

8. Configuring the Network Interface Board Using a Web Browser

Going to the Top Page.....	74
Types of Menu Configuration and Mode	75
Verifying the Network Interface Board Settings	77
Configuring the Network Interface Board Settings	78
Using Help on the Web Browser	79
Downloading Help	79

9. Appendix

Remote Maintenance by telnet	81
Using telnet	81
Commands List	82
Using DHCP	97
Using AutoNet	98
SNMP	99
Error Messages on the Display	100
Messages without Code Numbers	100
Messages with Code Numbers	101
Understanding Displayed Information	103
Print Job Information	103
Print Log Information	103
Machine Status and Configuration	104
Configuring the Network Interface Board	108
Message List	113
System Log Information	113
When Using Windows Terminal Service/MetaFrame	120
Operating Environment	120
Supported Printer Drivers	120
Limitation	120
Precautions	122
Connecting a Dial-Up Router to a Network	122
NetWare Printing	124
When Using IPP with SmartDeviceMonitor for Client	124
When the IEEE 80211.b interface unit (optional) Is Installed	125
Specifications	126
INDEX	127

How to Read This Manual

Symbols

In this manual, the following symbols are used:

WARNING:

This symbol indicates a potentially hazardous situation which, if instructions are not followed, could result in death or serious injury.

CAUTION:

This symbol indicates a potentially hazardous situation which, if instructions are not followed, may result in minor or moderate injury, or damage to property.

* The statements above are notes for your safety.

Important

If this instruction is not followed, paper might be misfed, originals might be damaged, or data might be lost. Be sure to read this.

Preparation

This symbol indicates prior knowledge or preparation is required before operation.

Note

This symbol indicates precautions for operation, or actions to take after mal-operation.

Limitation

This symbol indicates numerical limits, functions that cannot be used together, or conditions in which a particular function cannot be used.

Reference

This symbol indicates a reference.

[]

Keys that appear on the machine's display.

[]

Keys and buttons that appear on the computer's display.

[]

Keys built into the machine's control panel.

[]

Keys on the computer's keyboard.

Names of Major Options

The following software products are referred to using a general name:

- DeskTopBinder Lite and DeskTopBinder professional → DeskTopBinder
- ScanRouter V2 Lite, ScanRouter EX professional* and ScanRouter EX Enterprise → the ScanRouter delivery software

*Optional

1. Functions Available over a Network

This machine provides printer, LAN-Fax, Internet Fax, and scanner functions over a network.

Using the Printer

The network interface board is compatible with NetWare^{*1} (IPX/SPX, TCP/IP), Windows NT 4.0 (TCP/IP, NetBEUI^{*2}, IPP^{*3}), Windows 2000 (TCP/IP, NetBEUI^{*2}, IPP^{*3}), Windows XP (TCP/IP, IPP^{*3}), Windows Server 2003 (TCP/IP, IPP^{*3}), Windows 95/98/Me (TCP/IP, NetBEUI^{*2}, IPP^{*3}), UNIX (TCP/IP), and Macintosh (AppleTalk) protocols. This allows you to operate the machine in a network that uses different protocols and operating systems.

^{*1} If the optional 802.11b interface unit is installed, you can use only infrastructure mode.

^{*2} For NetBEUI, use the SmartDeviceMonitor for Client port.

^{*3} IPP (Internet Printing Protocol) is a protocol for printing via the Internet.

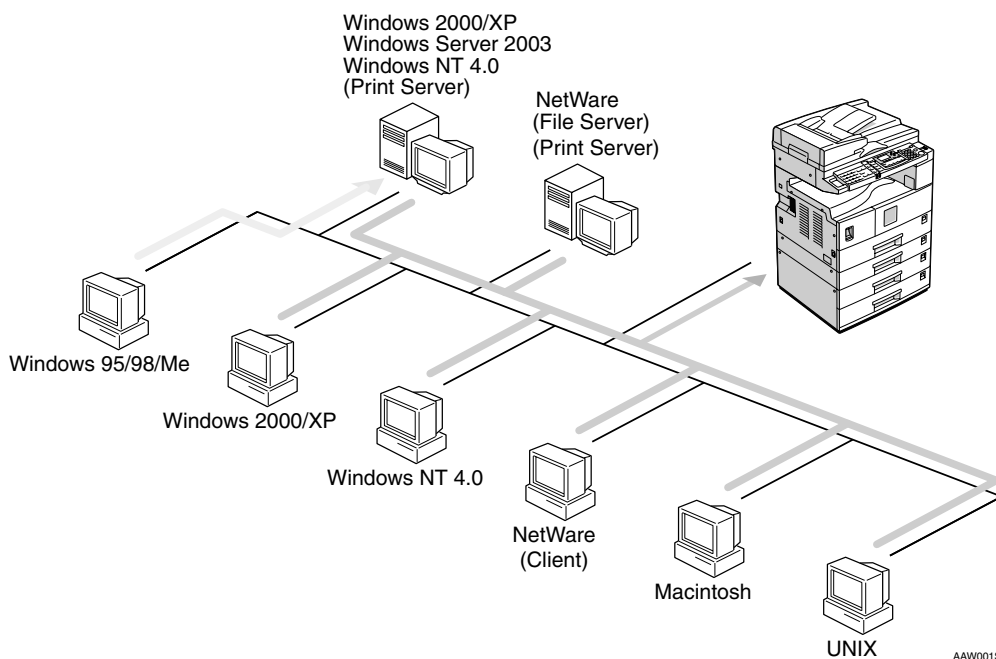

Reference

For details about what settings to make, see p.13 "Setting Up the Machine on a Network".

For details about using this function, see p.41 "Using the Printer Function".

Using Fax

1

Internet Fax

This machine converts scanned document images to e-mail format and transmits the data over the Internet.

Specify the e-mail address instead of the fax number, and then send the document.

E-mail can be received on a fax machine that supports Internet Fax, or on a computer that can receive normal e-mail.

You can also receive e-mails or Internet faxes, and then print or forward them.

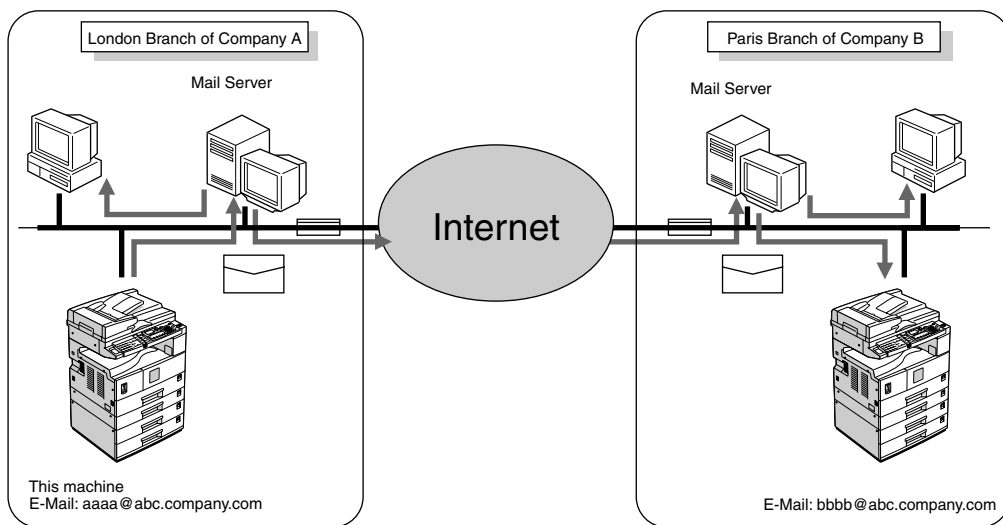

AAW002S1

For details about what settings to make, see p.13 “Setting Up the Machine on a Network”.

For details about using this function, see “Using Internet Fax Functions”, *Facsimile Reference <Basic Features>*.

LAN-Fax

You can fax documents over phone lines from any computer connected to the machine via Ethernet, IEEE 1394 (IP over 1394), or IEEE 802.11b (wireless LAN).

To send a fax, print from the Windows application you are working with, select LAN-Fax as the printer, and then specify the destination.

You can also check the sent image data.

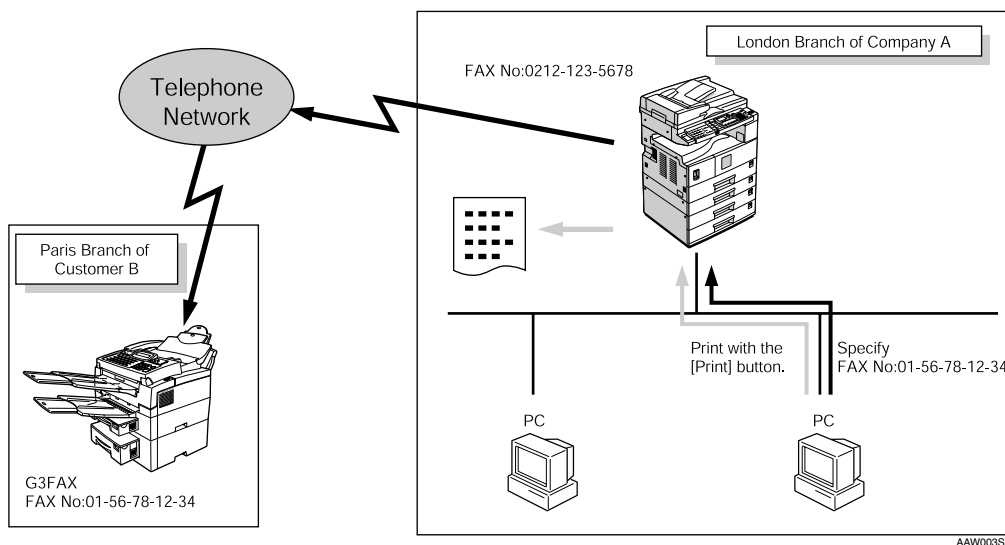

Reference

For details about what settings to make, see p.13 "Setting Up the Machine on a Network".

For details about using this function, see "Sending Fax Documents from Computers", *Facsimile Reference <Advanced Features>*.

Network Scanner

1

E-mail

Scan file attached to an e-mail can be sent using the e-mail system through a LAN or the Internet.

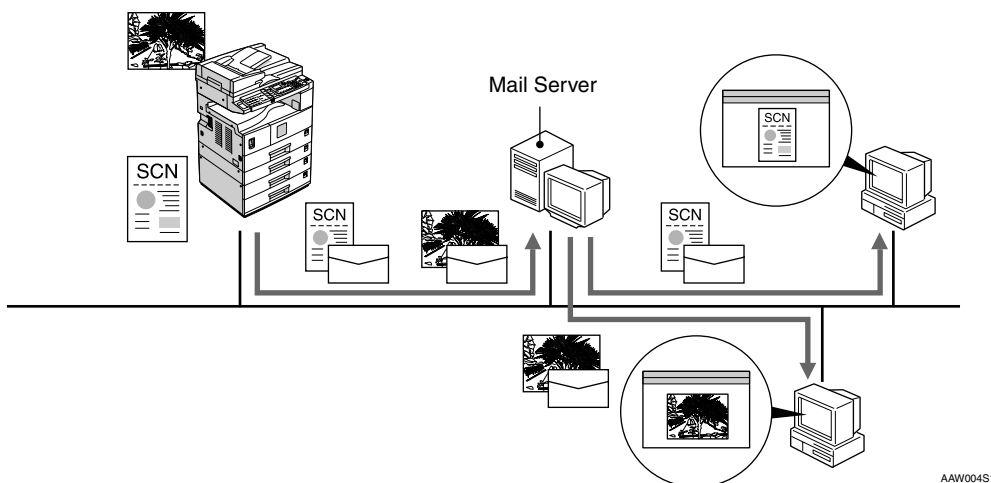

Reference

For details about what settings to make, see p.13 "Setting Up the Machine on a Network".

For details about using this function, see "Sending Scan Files by E-mail", *Scanner Reference*.

Network Delivery Scanner

You can use the machine as a delivery scanner for the ScanRouter delivery software.

Scan file or document received by fax can be stored in the delivery server, or delivered via the network to specified folders on client computers.

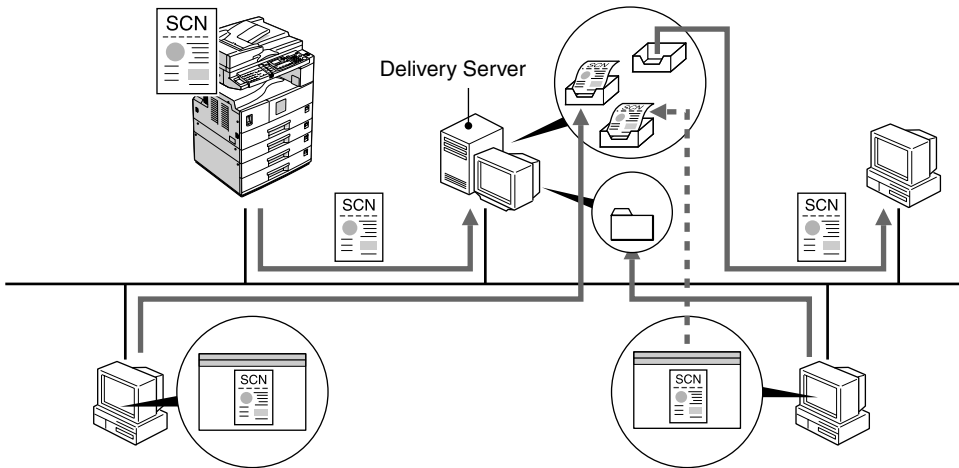

AAW005S1

Reference

For details about what settings to make, see p.13 “Setting Up the Machine on a Network”.

For details about using this function, see “Using the Network Delivery Scanner Function”, *Scanner Reference*.

Network TWAIN Scanner

1

You can use the scanning function of this machine from a computer connected via a network (Ethernet, IEEE 1394(IP over 1394), or IEEE 802.11b (wireless LAN)).

You can scan documents the same way you would if you were using a scanner connected directly to your computer.

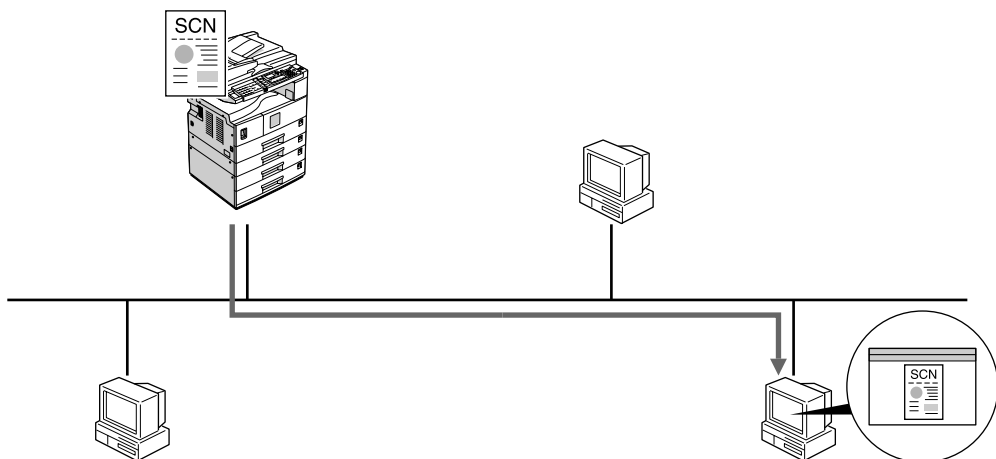

AAW006S1

Reference

For details about what settings to make, see p.13 “Setting Up the Machine on a Network”.

For details about using this function, see “Using the Network TWAIN Scanner Function”, *Scanner Reference*.

2. Connecting the Network Cable to the Network

Confirming the Connection

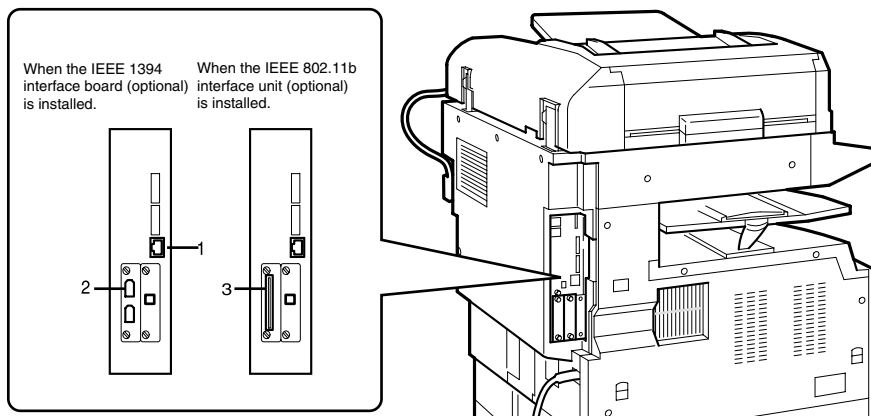

1. 10BASE-T/100BASE-TX port

Port for connecting the 10BASE-T or 100BASE-TX cable

2. IEEE 1394 ports (optional)

Ports for connecting the IEEE 1394 interface cable

3. Wireless LAN card (optional)

Port for using the wireless LAN

Connecting to the Ethernet Interface

The network interface board supports 10BASE-T or 100BASE-TX connections.

2

1 Turn off the main power switch.

Important

- Make sure the main power is off. See “Turning On the Power”, *Copy Reference*.

2 Loop the network interface cable and attach the ferrite core.

Note

- The network interface cable loop should be about 15 cm (6") (①) from the end of the cable (closest end to the printer). The ferrite core at the end of the cable should be a ring type.

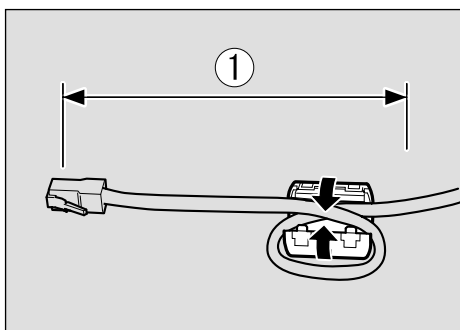

AAW026S1

3 Connect the Ethernet interface cable to the 10BASE-T/100BASE-TX port.

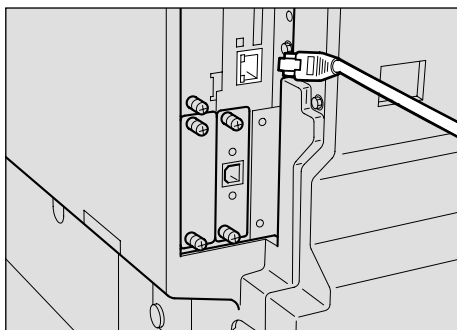

AAW023S1

4 Turn on the main power switch.

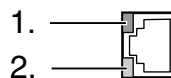

AAW022S1

1. Indicator (green)

Remains green when the machine is properly connected to the network.

2. Indicator (yellow)

Turns yellow when 100 BASE-TX is operating. Turns off when 10 BASE-T is operating.

Connecting to the IEEE 1394 Interface

Important

- ❑ Before making the connection, touch the metallic part to ground yourself.

Note

- ❑ Use the interface cable supplied with the IEEE 1394 interface board (optional).
- ❑ Make sure the interface cable is not looped.

- 1 Connect the IEEE 1394 interface cable to the IEEE 1394 ports.

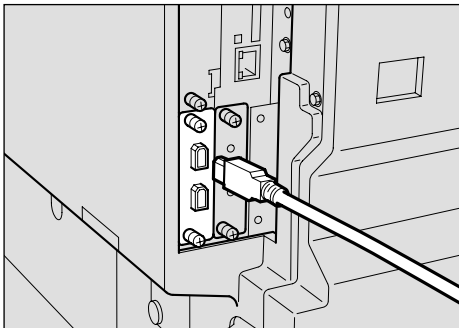

Note

- ❑ Two interface ports are available for connecting the IEEE 1394 interface cable. Either is suitable.

Using the IEEE 802.11b (Wireless LAN)

Setting the IEEE 802.11b (Wireless LAN)

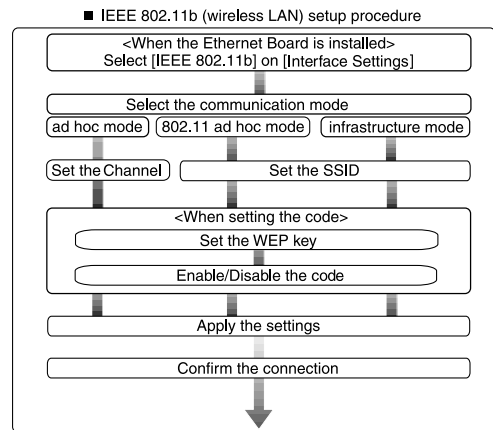

Note

- ❑ Select [802.11 Ad hoc] when connecting Windows XP as a wireless LAN client using Windows XP standard driver or utilities, or when not using the infrastructure mode.

Confirming the Connection

- 1 Make sure the LED of the IEEE 802.11b card is lit.

❖ When using in infrastructure mode

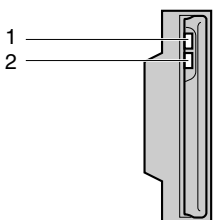

AAW027S1

1. If it is connected properly to the network, the LED is green when in infrastructure mode. If the LED is blinking, the machine is searching for devices.

2. If [LAN Type] on the [Interface Settings]/[Network] screen is not set to [IEEE 802.11b], it does not light, even if the main power is on.

❖ When using in ad hoc mode/802.11 ad hoc mode

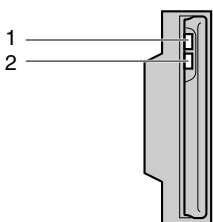

AAW027S1

1. If it is connected properly to the network, the LED is green when in ad hoc mode or 802.11 ad hoc mode. If the LED is blinking, the machine is searching for devices. The LED will light after a few seconds.

2. If the IEEE 802.11b card is working, it is lit in orange.

- 2 Print the configuration page to verify settings.

🔍 Reference

For more information about printing a configuration page, see *Printer Reference 2*.

Checking the machine's radio wave status

When using in infrastructure mode, you can check the machine's radio wave status using the control panel.

📝 Note

- ❑ To check the radio wave status, select [IEEE 802.11b] under [LAN Type] on the [Network] screen.

- 1 Press the [User Tools/Counter] key.
- 2 Select [System Settings] using [▲] or [▼], and then press the [OK] key.
- 3 Select [Interface Settings] using [▲] or [▼], and then press the [OK] key.
- 4 Select [IEEE 802.11b] using [▲] or [▼], and then press the [OK] key.
- 5 Select [Wireless LAN Signal] using [▲] or [▼], and then press the [OK] key.
The machine's radio wave status appears.
- 6 After checking the radio wave status, press the [User Tools/Counter] key.

3. Setting Up the Machine on a Network

User Tools Menu (System Settings)

This section describes the network settings you can change with User Tools (System Settings). Make settings according to functions you want to use and the interface to be connected.

Important

- These settings should be made by the systems administrator, or after consulting with the systems administrator.

Reference

For details about settings, see p.26 “Settings You Can Change with User Tools”

❖ Viewing the Information Displayed in the List

- These items must be set to use the function. Be sure to set them before attempting to use the corresponding function.
- These items must be set if required.

Printer (LAN-Fax)

Interface	Settings		
Ethernet	Interface Settings/ Network See p.26 “Interface Settings/Network”.	IP Address	●
		Gateway Address	○
		DNS Configuration	○
		WINS Configuration	○
		Effective Protocol *3	●
		NW Frame Type	○
		LAN Type *2	●
		Ethernet Speed	○
		Host Name	○
		Domain Name	○

Interface	Settings		
IEEE 1394 (IP over 1394)	Interface Settings/ IEEE 1394 ^{*1} See p.27 "Interface Settings/IEEE 1394".	IP Address	●
		WINS Configuration	○
		IP over 1394	●
		Host Name	○
		Domain Name	○
	Interface Settings/ Network See p.26 "Interface Settings/Network".	Gateway Address	○
		DNS Configuration	○
		Effective Protocol ^{*3}	●
	IEEE 802.11b (wireless LAN)	Interface Settings/ Network See p.26 "Interface Settings/Network".	IP Address
Gateway Address			○
DNS Configuration			○
WINS Configuration			○
Effective Protocol ^{*3}			●
NW Frame Type			○
LAN Type ^{*2}			●
Ethernet Speed			○
Host Name			○
Domain Name		○	
Interface Settings/ IEEE 802.11b ^{*2} See p.29 "Interface Settings/IEEE 802.11b".		Communication Mode	●
		SSID Setting	○
		Channel	○
		WEP (Encryption) Setting	○
		Communication Speed	○

^{*1} Appears when the IEEE 1394 interface board (optional) is installed.

^{*2} Appears when the IEEE 802.11b unit (optional) is installed.

If Ethernet and IEEE 802.11b (wireless LAN) are both connected to the machine, the selected interface has priority.

^{*3} Check **[Effective]** is selected for TCP/IP.

Internet Fax

Interface	Settings		
Ethernet	Interface Settings/ Network See p.26 "Interface Settings/Network".	IP Address	●
		Gateway Address	●
		DNS Configuration	○
		WINS Configuration	○
		Effective Protocol *5	●
		LAN Type *2	●
		Ethernet Speed	○
		Host Name	○
		Domain Name	○
	File Transfer See p.30 "File Trans- fer".	SMTP Server *3	●
		SMTP Authentication	○
		POP before SMTP	○
		Reception Protocol *4	●
		POP3/IMAP4 Settings *6	○
		Key Operator's E-mail Add. *8	○
		E-mail Reception Port *4 *7	●
		E-mail Recept. Interval	○
		Max. Recept. E-mail Size	○
		E-mail Storage in Server	○
		Prog./Change/Del. Subject	○
Fax Mail Reception Account *3 *4	●		

Interface	Settings		
IEEE 1394 (IP over 1394)	Interface Settings/ IEEE 1394 *1 See p.27 "Interface Settings/IEEE 1394".	IP Address	●
		WINS Configuration	○
		IP over 1394	●
		Host Name	○
		Domain Name	○
	Interface Settings/ Network See p.26 "Interface Settings/Network".	Gateway Address	●
		DNS Configuration	○
		Effective Protocol *5	●
	File Transfer See p.30 "File Trans- fer".	SMTP Server *3	●
		SMTP Authentication	○
		POP before SMTP	○
		Reception Protocol *4	●
		POP3/IMAP4 Settings *6	○
		Key Operator's E-mail Add. *8	○
		E-mail Reception Port *4 *7	●
		E-mail Recept. Interval	○
		Max. Recept. E-mail Size	○
		E-mail Storage in Server	○
		Prog./Change/Del. Subject	○
Fax Mail Reception Account *3 *4		●	

Interface	Settings		
IEEE 802.11b (wireless LAN)	Interface Settings/ Network See p.26 "Interface Settings/Network".	IP Address	●
		Gateway Address	●
		DNS Configuration	○
		WINS Configuration	○
		Effective Protocol *5	●
		LAN Type *2	●
		Ethernet Speed	○
		Host Name	○
		Domain Name	○
		Interface Settings/ IEEE 802.11b *2 See p.29 "Interface Settings/IEEE 802.11b".	Communication Mode
SSID Setting	○		
Channel	○		
WEP (Encryption) Setting	○		
Communication Speed	○		
File Transfer See p.30 "File Trans- fer".	SMTP Server *3	●	
	SMTP Authentication	○	
	POP before SMTP	○	
	Reception Protocol *4	●	
	POP3/IMAP4 Settings *6	○	
	Key Operator's E-mail Add. *8	○	
	E-mail Reception Port *4 *7	●	
	E-mail Recept. Interval	○	
	Max. Recept. E-mail Size	○	
	E-mail Storage in Server	○	
	Prog./Change/Del. Subject	○	
	Fax Mail Reception Account *3 *4	●	

*1 Appears when the IEEE 1394 interface board (optional) is installed.

*2 Appears when the IEEE 802.11b unit (optional) is installed.
If Ethernet and 802.11b (wireless LAN) are both connected to the machine, the selected interface has priority.

*3 Minimum settings required to use transmission.

*4 Minimum settings required to use reception.

To use SMTP reception, make an entry in the DNS server's MX record indicating this machine is capable of SMTP reception.

*5 Check **[Effective]** is selected for TCP/IP.

*6 If you select **[On]** for **[POP before SMTP]**, select this function also.

*7 If you select **[On]** for **[POP before SMTP]**, check the port number for **[POP3]**.

*8 If you select **[On]** for **[SMTP Authentication]**, select this function also.

E-mail

Interface	Settings		
Ethernet	Interface Settings/ Network See p.26 "Interface Settings/Network".	IP Address	●
		Gateway Address	●
		DNS Configuration	○
		WINS Configuration	○
		Effective Protocol *3	●
		LAN Type *2	●
		Ethernet Speed	○
		Host Name	○
		Domain Name	○
	File Transfer See p.30 "File Trans- fer".	SMTP Server	●
		SMTP Authentication	○
		POP before SMTP	○
		POP3/IMAP4 Settings *4	○
		Key Operator's E-mail Add.	○
E-mail Reception Port *5		○	
Prog./Change/Del. Subject		○	
IEEE 1394 (IP over 1394)	Interface Settings/ IEEE 1394 *1 See p.27 "Interface Settings/IEEE 1394".	IP Address	●
		WINS Configuration	○
		IP over 1394	●
		Host Name	○
		Domain Name	○
	Interface Settings/ Network See p.26 "Interface Settings/Network".	Gateway Address	●
		DNS Configuration	○
		Effective Protocol *3	●
	File Transfer See p.30 "File Trans- fer".	SMTP Server	●
		SMTP Authentication	○
		POP before SMTP	○
		POP3/IMAP4 Settings *4	○
		Key Operator's E-mail Add.	○
		E-mail Reception Port *5	○
		Prog./Change/Del. Subject	○

Interface	Settings		
IEEE 802.11b (wireless LAN)	Interface Settings/ Network	IP Address	●
	See p.26 "Interface Settings/Network".	Gateway Address	●
		DNS Configuration	○
		WINS Configuration	○
		Effective Protocol *3	●
		LAN Type *2	●
		Ethernet Speed	○
		Host Name	○
	Domain Name	○	
Interface Settings/ IEEE 802.11b *2	See p.29 "Interface Settings/IEEE 802.11b".	Communication Mode	●
		SSID Setting	○
		Channel	○
		WEP (Encryption) Setting	○
		Communication Speed	○
File Transfer See p.30 "File Trans- fer".		SMTP Server	●
		SMTP Authentication	○
		POP before SMTP	○
		POP3/IMAP4 Settings *4	○
		Key Operator's E-mail Add.	○
		E-mail Reception Port *5	○
		Prog./Change/Del. Subject	○

*1 Appears when the IEEE 1394 interface board (optional) is installed.

*2 Appears when the 802.11b unit (optional) is installed.

If Ethernet and 802.11b (wireless LAN) are both connected to the machine, the selected interface has priority.

*3 Check **[Effective]** is selected for TCP/IP.

*4 If you select **[On]** for **[POP before SMTP]**, select this function as well.

*5 If you select **[On]** for **[POP before SMTP]**, check the port number for **[POP3]**.

Network Delivery Scanner

Interface	Settings		
Ethernet	Interface Settings/ Network See p.26 "Interface Settings/Network".	IP Address	●
		Gateway Address	○
		DNS Configuration	○
		WINS Configuration	○
		Effective Protocol *4	●
		LAN Type *2	●
		Ethernet Speed	○
		Host Name	○
	Domain Name	○	
File Transfer See p.30 "File Trans- fer".	Delivery Option *3	○	
IEEE 1394 (IP over 1394)	Interface Settings/ IEEE 1394 *1 See p.27 "Interface Settings/IEEE 1394".	IP Address	●
		WINS Configuration	○
		IP over 1394	●
		Host Name	○
		Domain Name	○
	Interface Settings/ Network See p.26 "Interface Settings/Network".	Gateway Address	○
		DNS Configuration	○
		Effective Protocol *4	●
	File Transfer See p.30 "File Trans- fer".	Delivery Option *3	○

Interface	Settings		
IEEE 802.11b (wireless LAN)	Interface Settings/ Network See p.26 "Interface Settings/Network".	IP Address	●
		Gateway Address	○
		DNS Configuration	○
		WINS Configuration	○
		Effective Protocol *4	●
		LAN Type *2	●
		Ethernet Speed	○
		Host Name	○
		Domain Name	○
	Interface Settings/ IEEE 802.11b *2 See p.29 "Interface Settings/IEEE 802.11b".	Communication Mode	●
		SSID Setting	○
		Channel	○
		WEP (Encryption) Setting	○
		Communication Speed	○
	File Transfer See p.30 "File Trans- fer".	Delivery Option *3	○

*1 Appears when the IEEE 1394 interface board (optional) is installed.

*2 Appears when the IEEE 802.11b unit (optional) is installed.

If Ethernet and IEEE 802.11b (wireless LAN) are both connected to the machine, the selected interface has priority.

*3 When delivery option is set to **[On]**, make sure the IP address is set.

*4 Check **[Effective]** is selected for TCP/IP.

Network TWAIN Scanner

Interface	Settings		
Ethernet	Interface Settings/ Network See p.26 "Interface Settings/Network".	IP Address	<input checked="" type="radio"/>
		Gateway Address	<input type="radio"/>
		DNS Configuration	<input type="radio"/>
		WINS Configuration	<input type="radio"/>
		Effective Protocol ^{*3}	<input checked="" type="radio"/>
		LAN Type ^{*2}	<input checked="" type="radio"/>
		Ethernet Speed	<input type="radio"/>
		Host Name	<input type="radio"/>
		Domain Name	<input type="radio"/>
IEEE 1394 (IP over 1394)	Interface Settings/ IEEE 1394 ^{*1} See p.27 "Interface Settings/IEEE 1394".	IP Address	<input checked="" type="radio"/>
		WINS Configuration	<input type="radio"/>
		IP over 1394	<input checked="" type="radio"/>
		Host Name	<input type="radio"/>
		Domain Name	<input type="radio"/>
	Interface Settings/ Network See p.26 "Interface Settings/Network".	Gateway Address	<input type="radio"/>
		DNS Configuration	<input type="radio"/>
		Effective Protocol ^{*3}	<input checked="" type="radio"/>
IEEE 802.11b (wireless LAN)	Interface Settings/ Network See p.26 "Interface Settings/Network".	IP Address	<input checked="" type="radio"/>
		Gateway Address	<input type="radio"/>
		DNS Configuration	<input type="radio"/>
		WINS Configuration	<input type="radio"/>
		Effective Protocol ^{*3}	<input checked="" type="radio"/>
		LAN Type ^{*2}	<input checked="" type="radio"/>
		Ethernet Speed	<input type="radio"/>
		Host Name	<input type="radio"/>
		Domain Name	<input type="radio"/>
	Interface Settings/ IEEE 802.11b ^{*2} See p.29 "Interface Settings/IEEE 802.11b".	Communication Mode	<input checked="" type="radio"/>
		SSID Setting	<input type="radio"/>
		Channel	<input type="radio"/>
		WEP (Encryption) Setting	<input type="radio"/>
		Communication Speed	<input type="radio"/>

^{*1} Appears when the IEEE 1394 interface board (optional) is installed.

^{*2} Appears when the IEEE 802.11b unit (optional) is installed.

If Ethernet and 802.11b (wireless LAN) are both connected to the machine, the selected interface has priority.

^{*3} Check **[Effective]** is selected for TCP/IP.

Network Configuration

Any change you make with User Tools remains in effect even if the main power switch or operation switch is turned off, or the **[Clear Modes]** key is pressed.

Configuring the network using the control panel

Note

- Operations for System Settings are different from normal operations. After using User Tools, press the **[User Tools/Counter]** key to exit.
- If the key operator code has been set, the key operator code entry screen appears. Enter the code, and then press the **[OK]** key. For details about the key operator code, see *General Settings Guide*.

- 1** Press the **[User Tools/Counter]** key.
- 2** Select **[System Settings]** using **[▲]** or **[▼]**, and then press the **[OK]** key.
- 3** Select **[Interface Settings]** or **[File Transfer]** using **[▲]** or **[▼]**, and then press the **[OK]** key.
- 4** Select the setting you want to change, and then press the **[OK]** key.
- 5** Change the setting, and then press the **[OK]** key.

Note

- Press the **[Cancel]** key to cancel the setting.

- 6** Press the **[User Tools/Counter]** key.

Configuring the network using other utilities

As well as using the control panel to make network settings, utilities such as a Web browser and SmartDeviceMonitor for Admin can also be used. The following table shows available settings:

Note

- Indicates machine settings can be changed.
- Indicates the setting cannot be changed from that device.

Name on the control panel				Web browser	SmartDeviceMonitor for Admin	telnet	
Interface Settings	Network	IP Address	Auto-Obtain (DHCP)	○	○	○	
			Specify	IP Add.	○	○	○
				Subnet M	○	○	○
				Mac Add.	-	-	-
	Gateway Address			○	○	○	

Name on the control panel					Web browser	SmartDeviceMonitor for Admin	telnet
Interface Settings	Network	DNS Configuration	Specify	Server 1	<input type="radio"/>	-	<input type="radio"/>
				Server 2	<input type="radio"/>	-	<input type="radio"/>
				Server 3	<input type="radio"/>	-	<input type="radio"/>
		WINS Configuration	Server		<input type="radio"/>	-	<input type="radio"/>
			Scope ID		<input type="radio"/>	-	<input type="radio"/>
		NW Frame Type	Auto Select		<input type="radio"/>	-	<input type="radio"/>
			Ethernet II		<input type="radio"/>	-	<input type="radio"/>
			Ethernet 802.2		<input type="radio"/>	-	<input type="radio"/>
			Ethernet 802.3		<input type="radio"/>	-	<input type="radio"/>
			Ethernet SNAP		<input type="radio"/>	-	<input type="radio"/>
		LAN Type	Ethernet		<input type="radio"/>	-	<input type="radio"/>
			IEEE 802.11b		<input type="radio"/>	-	<input type="radio"/>
		Ethernet Speed			-	-	-
		Effective Protocol	TCP/IP		-	<input type="radio"/> *1	<input type="radio"/>
			NetWare		<input type="radio"/>	<input type="radio"/> *2	<input type="radio"/>
	SMB		<input type="radio"/>	<input type="radio"/>	<input type="radio"/>		
	AppleTalk		<input type="radio"/>	<input type="radio"/>	<input type="radio"/>		
	SNMP		<input type="radio"/>	<input type="radio"/>	<input type="radio"/>		
	Host Name			<input type="radio"/>	<input type="radio"/>	<input type="radio"/>	
	Domain Name			<input type="radio"/>	-	<input type="radio"/>	
	IEEE 1394	IP Address	Specify	IP Add.	<input type="radio"/>	-	<input type="radio"/>
				Subnet M	<input type="radio"/>	-	<input type="radio"/>
				Mac Add.	-	-	-
WINS Configuration		Server		<input type="radio"/>	-	<input type="radio"/>	
		Scope ID		<input type="radio"/>	-	<input type="radio"/>	
IP over 1394			<input type="radio"/>	-	<input type="radio"/>		
SCSI print (SBP-2)			<input type="radio"/>	-	<input type="radio"/>		
Bidirectional SCSI print			<input type="radio"/>	-	<input type="radio"/>		
Host Name			<input type="radio"/>	-	<input type="radio"/>		
Domain Name			<input type="radio"/>	-	<input type="radio"/>		

Name on the control panel			Web browser	SmartDeviceMonitor for Admin	telnet
Interface Settings	IEEE 802.11b	Communication Mode	<input type="radio"/>	-	<input type="radio"/>
		SSID Setting	<input type="radio"/>	-	<input type="radio"/>
		Channel	<input type="radio"/>	-	<input type="radio"/>
		WEP (Encryption) Setting	<input type="radio"/>	-	<input type="radio"/>
		Communication Speed	-	-	<input type="radio"/>
File Transfer	Delivery Option		-	-	-
	SMTP Server		<input type="radio"/>	-	-
	SMTP Authentication		<input type="radio"/>	-	-
	POP before SMTP		<input type="radio"/>	-	-
	Reception Protocol		<input type="radio"/>	-	-
	POP3/IMAP4 Settings		<input type="radio"/>	-	-
	Key Operator's E-mail Add.		<input type="radio"/>	-	-
	E-mail Reception Port		<input type="radio"/>	-	-
	E-mail Recept. Interval		<input type="radio"/>	-	-
	Max. Recept. E-mail Size		<input type="radio"/>	-	-
	E-mail Storage in Server		<input type="radio"/>	-	-
	Prog./Change/Del. Subject		-	-	-
	Fax Mail Reception Account		-	-	-

*1 You can make the TCP/IP settings if SmartDeviceMonitor for Admin is communicating with the machine using IPX/SPX.

*2 You can make the IPX/SPX settings if SmartDeviceMonitor for Admin is communicating with the machine using TCP/IP.

Settings You Can Change with User Tools

Interface Settings/Network

❖ IP Address

Before using this machine in the network environment, you must configure the IP address and sub-net mask.

- Auto-Obtain (DHCP)
- Specify
When you select **[Specify]**, enter **[IP Address:]** and **[Sub-net Mask:]** as "xxx.xxx.xxx.xxx" ("x" indicates a number).
 - IP Address: 011.022.033.044
 - Sub-net Mask: 000.000.000.000

Note

- Default: *Auto-Obtain (DHCP)*
- If you use the interface for Ethernet and IEEE 1394 (IP over 1394) at the same time, settings must be made carefully. See p.97 "Using DHCP"
- If you install the IEEE 1394 interface board (optional) and use the IEEE 1394 interface, you must set the address of the domain, different from the **[IP Address:]** of **[IEEE 1394]**. If you intend to set the address for the same domain, set a different value for **[Sub-net Mask:]**.
- When you select **[Specify]**, be sure not to set the same **[IP Address:]** as that of another machines on the network.
- The physical address (MAC address) also appears.

❖ Gateway Address

A gateway is a connection or interchange point between two networks. Configure the gateway address for the router or host computer used as a gateway.

- Gateway Address:000.000.000.000

Note

- Default: *000.000.000.000*

❖ DNS Configuration

Make settings for the DNS server.

- Specify
When you select **[Specify]**, enter the DNS server IP address as "xxx.xxx.xxx.xxx" ("x" indicates a number).
 - DNS Server 1:000.000.000.000
 - DNS Server 2:000.000.000.000
 - DNS Server 3:000.000.000.000

Note

- Default: *Specify*

❖ WINS Configuration

You can specify the WINS server settings.

- On
If **[On]** is selected, enter the **[Server]** IP address as "xxx.xxx.xxx.xxx" ("x" indicates a number).
If DHCP is in use, specify the **[Scope ID]**.
 - WINS Server:000.000.000.000
 - Scope ID
- Off

Limitation

- Enter a **[Scope ID]** using up to 31 alphanumeric characters.

Note

- Default: *Off*

❖ **Effective Protocol**

Select the protocol to use in the network.

- TCP/IP:Effective/Invalid
- NetWare:Effective/Invalid
- SMB:Effective/Invalid
- AppleTalk:Effective/Invalid

📌 **Note**

- Default: *TCP/IP: Effective, NetWare: Effective, SMB: Effective, AppleTalk: Effective*

❖ **NW Frame Type**

Select the frame type when you use NetWare.

- Auto Select
- Ethernet II
- Ethernet 802.2
- Ethernet 802.3
- Ethernet SNAP

📌 **Note**

- Default: *Auto Select*

❖ **LAN Type**

Select interface, IEEE 802.11b (wireless LAN) or Ethernet.

- Ethernet
- IEEE 802.11b

📌 **Note**

- Default: *Ethernet*
- Appears when the IEEE 802.11b unit is installed.
- If Ethernet and IEEE 802.11b (wireless LAN) are both connected to the machine, the selected interface takes precedence.

❖ **Ethernet Speed**

Set the access speed for networks. Select a speed that matches your network environment. **[Auto Select]** should usually be selected.

- Auto Select
- 100Mbps Fixed
- 10Mbps Fixed

📌 **Note**

- Default: *Auto Select*

❖ **Host Name**

Specify the host name.

❖ **Domain Name**

Specify the domain name.

Interface Settings/IEEE 1394

📁 **Preparation**

You must install the IEEE 1394 interface board (optional) in the machine.

❖ **IP Address**

When you connect the machine to a network using the IEEE 1394 interface, you must configure the IP address and subnet mask.

- Auto-Obtain (DHCP)
- Specify

When you select **[Specify]**, enter **[IP Address:]** and **[Sub-net Mask:]** as "xxx.xxx.xxx.xxx" ("x" indicates a number).

 - IP Address: 011.022.033.044
 - Sub-net Mask: 000.000.000.000

📌 **Note**

- Default: *Auto-Obtain (DHCP)*
- If you use the interface for Ethernet and IEEE 1394 (IP over 1394) at the same time, settings must be made carefully. See p.97 "Using DHCP"

- When you use the IEEE 1394 interface on a network, you cannot use the Ethernet interface in the same domain. To use both interfaces in the same domain, set different values for **[Sub-net Mask:]**.
- The physical address (MAC address) also appears.

❖ WINS Configuration

You can specify the WINS server settings.

- On
If **[On]** is selected, specify the **[Server]** IP address as "xxx.xxx.xxx.xxx" ("xxx" indicates a number).
If DHCP is in use, specify **[Scope ID]**.
 - WINS Server:000.000.000.000
 - Scope ID

- Off

! Limitation

- Enter **[Scope ID]** using up to 31 alphanumeric characters.

Note

- Default: *Off*

❖ IP over 1394

When you use the IP over 1394 function of the IEEE 1394 interface to connect the machine to the network, or you print from computer with the IP over 1394 driver, you must specify **[Active]** for **[IP over 1394]**.

- Active
- Inactive

! Limitation

- Printing with IP over 1394 is possible under Windows Me/XP and Windows Server 2003.

Note

- Default: *Active*

❖ SCSI print (SBP-2)

When you print using the SCSI print client function supported by Windows 2000, Windows XP, or Windows Server 2003, you must set **[SCSI print (SBP-2)]**.

- Active
- Inactive

! Limitation

- The IEEE 1394 interface can be used when Windows 2000 Service Pack 1 or later is installed. If the Service Pack is not installed, only one SCSI print device is connectable via 1394 bus.

Note

- Default: *Active*

❖ Bidirectional SCSI print

Specifies the printer's response mode etc. for status requests when using the IEEE 1394 interface.

- On
- Off

Note

- Default: *On*
- If this is set to **[Off]**, bidirectional communication will not work.

❖ Host Name

Specify the host name.

❖ Domain Name

Specify the domain name.

Interface Settings/IEEE 802.11b

Preparation

You must install the IEEE 802.11b unit (optional) into the machine.

Note

- Be sure to make all settings simultaneously.

❖ Communication Mode

Specifies the communication mode of the wireless LAN.

- 802.11 Ad hoc
- Ad hoc
- Infrastructure

Note

- Default: *802.11 Ad hoc*

❖ SSID Setting

Specifies SSID to distinguish the access point in infrastructure mode or 802.11 ad hoc mode.

Limitation

- The characters that can be used are ASCII 0x20-0x7e (32 bytes).

Note

- Default: *blank*

❖ Channel

Specifies a channel when you select 802.11b ad hoc mode or ad hoc mode.

Note

- Default: *11*
- The following channels are available:
 - Metric version: 1-13
 - Inch version: 1-11

❖ WEP (Encryption) Setting

Specifies the encryption of the IEEE 802.11b (wireless LAN). If this is set to **[Active]**, you must enter the WEP key.

- Active
- Inactive

Limitation

- 10 alphanumeric characters must be entered for 64 bit, 26 alphanumeric characters for 128 bit.

Note

- Default: *Inactive*

❖ Wireless LAN Signal

Shows the radio wave conditions of the access point connected in infrastructure mode.

Note

- Radio wave status is displayed when you press **[Wireless LAN Signal]**.

❖ Communication Speed

Specifies the communication speed of the IEEE 802.11b (wireless LAN).

- Auto
- 11Mbps Fixed
- 5.5Mbps Fixed
- 2Mbps Fixed
- 1Mbps Fixed

Note

- Default: *Auto*

❖ Return to Defaults

You can return the IEEE 802.11b (wireless LAN) settings to their defaults.

- No
- Yes

Interface Settings/Print I/F Settings List

You can check items related to the network in use.

Reference

For details about printing, see p.34 “Printing the interface settings lists”.

File Transfer

❖ Delivery Option

Enables or disables sending scanned documents via the the ScanRouter delivery software delivery server.

- On
 - Server1
 - Server2
- Off

Note

- Default: *Off*
- Set this option when specifying whether or not to use the ScanRouter delivery software. If you do, you will have to re-register I/O devices in the ScanRouter delivery software.

❖ SMTP Server

Specify the SMTP server name.

If DNS is in use, enter the host name.

If DNS is not in use, enter the SMTP server IP address.

- Server Name
- Port No.

Limitation

- Enter the **[Server Name]** using up to 127 alphanumeric characters. Spaces cannot be used.

Note

- Default: *Port No./25*
- Enter **[Port No.]** between 1 and 65535 using the number keys, and then press the **[OK]** key.

❖ SMTP Authentication

You can configure SMTP authentication (PLAIN, LOGIN, CRAM-MD5).

Authentication prevents unauthorized access, by making users enter a user name and password when sending e-mail to the SMTP server.

- On

If the SMTP server requires authentication, set **[SMTP Authentication]** to **[On]**, and then specify **[User Name:]**, **[Password:]**, and **[Encrypt:]**.

 - User Name:
 - Password:
 - Encrypt:
Auto/On/Off
- Off

Limitation

- Enter **[User Name:]** using up to 191 alphanumeric characters. Spaces cannot be used.
- Depending on the SMTP server type, “realm” must be specified. Add “@” after the user name, as in “user name@realm”.
- Enter **[Password:]** using up to 63 alphanumeric characters. Spaces cannot be used.
- Enter the user name and password to be set for **[Key Operator's E-mail Add.]** when using Internet Fax.

 **Note**

- Default: *Off*
- [Encrypt:]**-**[Auto]**: If the authentication method is PLAIN, LOGIN, or, CRAM-MD5.
- [Encrypt:]**-**[On]**: If the authentication method is CRAM-MD5.
- [Encrypt:]**-**[Off]**: If the authentication method is PLAIN, or LOGIN.

❖ POP before SMTP

You can configure POP authentication (POP before SMTP).

Authentication prevents unauthorized access, by authenticating with the POP server before sending e-mail to the SMTP server.

- On
 - To enable POP server authentication before sending e-mail via the SMTP server, set **[POP before SMTP]** to **[On]**.
 - E-mail is sent to the SMTP server after the time specified for **[Wait Time after Auth.:]** has elapsed.
 - Wait Time after Auth.: 300msec
 - User Name:
 - Password:
- Off

 **Limitation**

- Enter **[User Name:]** using up to 63 alphanumeric characters. Spaces cannot be used.
- Enter **[Password:]** using up to 63 alphanumeric characters. Spaces cannot be used.

 **Note**

- Default: *Off*
- Using the number keys, you can set **[Wait Time after Auth.:]** from zero to 10,000 milliseconds, in increments of one millisecond.
- If you select **[On]**, enter **[Server Name]** in **[POP3/IMAP4 Settings]**. Also, check the port number for **[POP3]** in **[E-mail Reception Port]**.

❖ Reception Protocol

Specify Reception Protocol for receiving Internet faxes.

- Off
- POP3
- IMAP4
- SMTP

 **Note**

- Default: *Off*

❖ POP3/IMAP4 Settings

Specify the POP3/IMAP4 **[Server Name:]** for receiving Internet faxes. The specified POP3 server name is used for **[POP before SMTP]**.

If DNS is in use, enter the host name.

If DNS is not in use, enter the POP3 or IMAP4 server IP address.

- Server Name:
- Encrypt:
 - Auto
 - On
 - Off

 **Limitation**

- Enter POP3 or IMAP4 **[Server Name:]** using to 127 alphanumeric characters. Spaces cannot be used.

 **Note**

- [Encrypt]-[Auto]:** Password encryption is automatically set according to the POP server settings.
- [Encrypt]-[On]:** Encrypt password.
- [Encrypt]-[Off]:** Do not encrypt password.

❖ **Key Operator's E-mail Add.**

If the sender is not specified on e-mailed scanned documents, this appears as the sender's address.

This can be used as the sender with SMTP authentication for Internet Fax. If **[On]** is selected for **[SMTP Authentication]** be sure to enter the key operator's e-mail address here.

This can be used as the destination for data transmission result cc e-mails, as well as the destination for data communication management e-mail.

 **Limitation**

- Enter up to 128 alphanumeric characters.

 **Note**

- If **[None]** is selected in **[Sender's Name Default]**, specify the sender's name when sending scanned document e-mail.

❖ **E-mail Reception Port**

Specify the **[POP3]**, **[IMAP4]**, and **[SMTP]** port numbers for receiving Internet faxes.

The specified POP3 port number is used for **[POP before SMTP]**.

- POP3
- IMAP4
- SMTP

 **Note**

- Default: *POP3/110, IMAP4/143, SMTP/25*
- Enter a port number between 1 and 65535 using the number keys, and then press the **[OK]** key.

❖ **E-mail Recept. Interval**

Specify, in minutes, the time limit for receiving Internet faxes via POP3 or IMAP4 server.

- On
- Off

 **Note**

- Default: *On/15 minute(s)*
- If **[On]** is selected, the number of times can be set from two to 1440 in increments of one minute, using the number keys.

❖ **Max. Recept. E-mail Size**

Specify **[Max. Recept. E-mail Size]** for receiving Internet faxes.

 **Note**

- Default: *2MB*
- Using the number keys, enter a size from one to two MB in increments of one megabyte.

❖ **E-mail Storage in Server**

You can specify whether or not to store received Internet fax e-mails on the POP3 or IMAP4 server.

- Off
- All
- Errors Only

 **Note**

- Default: *Off*

❖ Prog./Change/Del. Subject

You can program, change, or delete the subject used when sending an Internet fax or scan file as an attachment.

- Program/Change
- Delete

Note

- Enter a subject using up to 20 alphanumeric characters.

❖ Fax Mail Reception Account

Specify [E-mail Address], [User Name], and [Password] for receiving Internet faxes.

- E-mail Address
- User Name
- Password

📌 Limitation

- Enter an e-mail address using up to 128 alphanumeric characters.
- Enter a user name using up to 64 alphanumeric characters.
- Enter a password using up to 64 alphanumeric characters.

Programming, changing, or deleting a subject

📌 Limitation

- Enter a subject using up to 20 alphanumeric characters.

Note

- [Urgent] and [High] are programmed as the e-mail subjects.

1 Press the [User Tools/Counter] key.

2 Select [System Settings] using [▲] or [▼], and then press the [OK] key.

3 Select [File Transfer] using [▲] or [▼], and then press the [OK] key.

4 Select [Prog./Change/Del. Subject] using [▲] or [▼], and then press the [OK] key.

Programming a subject

1 Select [Program/Change] using [▲] or [▼], and then press the [OK] key.

2 Select [*Not programmed] using [▲] or [▼], and then press the [OK] key.

3 Enter the text, and then press the [OK] key.

Reference

For details about entering text, see “Entering Text”, *General Settings Guide*.

Changing a subject

1 Select [Program/Change] using [▲] or [▼], and then press the [OK] key.

2 Select the subject using [▲] or [▼], and then press the [OK] key.

3 Enter the text, and then press the [OK] key.

Reference

For details about entering text, see “Entering Text”, *General Settings Guide*.

Deleting a subject

1 Select [Delete] using [▲] or [▼], and then press the [OK] key.

2 Select the subject using [▲] or [▼], and then press the [OK] key.

Confirmation message appears.

3 To delete the subject, press [Yes].

5 Press the [User Tools/Counter] key.

Printing the interface settings lists

The interface settings lists show current network settings and information.

1 Press the [User Tools/Counter] key.

2 Select [System Settings] using [▲] or [▼], and then press the [OK] key.

3 Select [Interface Settings] using [▲] or [▼], and then press the [OK] key.

4 Select [Print I/F Settings List] using [▲] or [▼], and then press the [OK] key.

5 Press the [Start] key.

The interface settings lists are printed.

6 Press the [User Tools/Counter] key.

4. Windows Configuration

Configuring TCP/IP

This describes how to configure Windows for TCP/IP and IPP.

Configuring a Windows 95/98/Me Computer

Follow the procedure below to configure a Windows 95/98/Me computer to use TCP/IP.

- 1 Open [Control Panel], and then double-click the Network icon. Make sure [TCP/IP] is selected in the [The following network components are installed] box on the [Configuration] tab.

 **Note**

- Select TCP/IP if it is not already selected.
- Under Windows Me, if you want to use IEEE 1394 (IP over 1394) interface, make sure TCP/IP is bound to the IEEE 1394 adaptor being used. The following message appears:
TCP/ IP -> (IEEE 1394 adaptor in use)
- If TCP/IP is not installed, click [Add] on the [Configuration] tab to install it. For more information about installing TCP/IP, see Windows 95/98/Me Help.

- 2 Click [Properties].
- 3 Configure TCP/IP using the appropriate IP address, subnet mask, and other settings.

Check with the network administrator that the settings are correct.

Configuring a Windows 2000 Computer

Follow the procedure below to configure a Windows 2000 computer to use TCP/IP.

- 1 On the [Start] menu, point to [Settings], and then click [Network and Dial-up Connections].
- 2 Double-click [Local Area Connection]. On the [General] tab, click [Properties].
- 3 Make sure [Internet Protocol (TCP/IP)] is selected in the [Components checked are used by this connection] box on the [General] tab.

 **Note**

- Select TCP/IP if it is not already selected.
- If TCP/IP is not installed, click [Install] on the [General] tab to install it. For more information about installing TCP/IP, see Windows 2000 Help.

- 4 Click [Properties].
- 5 Configure TCP/IP using the appropriate IP address, subnet mask, and other settings.

Check with the network administrator that the settings are correct.

Configuring a Windows XP Computer

Follow the procedure below to configure a Windows XP computer to use TCP/IP.

1 On the [Start] menu, click [Control Panel], and then click [Network and Internet Connections].

2 Click [Network Connections], and then double-click [Local Area Connection].

 **Note**

If you want to use IEEE 1394 (IP over 1394) interface, click [1394 Connection].

3 On the [General] tab, click [Properties].

4 Make sure [Internet Protocol (TCP/IP)] is selected in the [This connection uses the following items] box on the [General] tab.

 **Note**

Select TCP/IP if it is not already selected.

If TCP/IP is not installed, click [Install] on the [General] tab to install it. For more information about installing TCP/IP, see Windows XP Help.

5 Click [Properties].

6 Configure TCP/IP using the appropriate IP address, subnet mask, and other settings.

Check with the network administrator that the settings are correct.

Configuring a Windows Server 2003 computer

Follow the procedure below to configure a Windows Server 2003 computer to use TCP/IP.

1 On the [Start] menu, point to [Control Panel], point to [Network Connections], and then click [Local Area Connection].

 **Note**

If you want to use IEEE 1394 (IP over 1394) interface, click [1394 Connection].

2 On the [General] tab, click [Properties].

3 Make sure [Internet Protocol (TCP/IP)] is selected in the [This connection uses the following items] box on the [General] tab.

 **Note**

Select TCP/IP if it is not already selected.

If TCP/IP is not installed, click [Install] on the [General] tab to install it. For more information about installing TCP/IP, see Windows Server 2003 Help.

4 Click [Properties].

5 Configure TCP/IP using the appropriate IP address, subnet mask, and other settings.

Check with the network administrator that the settings are correct.

Configuring a Windows NT 4.0 Computer

Follow the procedure below to configure a Windows NT 4.0 computer to use TCP/IP.

- 1** Open [Control Panel], and then double-click the Network icon. Make sure [TCP/IP Protocol] is selected in the [Network protocols] box on the [Protocols] tab.

 **Note**

- Select TCP/IP if it is not already selected.
- If TCP/IP is not installed, click [Add] on the [Protocols] tab to install it. For more information about installing TCP/IP, see Windows NT 4.0 Help.

- 2** Click [Properties].
- 3** Configure TCP/IP using the appropriate IP address, subnet mask, and other settings.

Check with the network administrator that the settings are correct.

Configuring NetBEUI

This describes how to configure Windows to use NetBEUI.

Limitation

- NetBEUI cannot be used under Windows XP.

Note

- NetBEUI appears as SMB in the control panel, manual, and related utilities.

4

Configuring a Windows 95/98/Me Computer

Follow the procedure below to configure a Windows 95/98/Me computer to use NetBEUI.

- 1** Open **[Control Panel]**, and then double-click the **Network** icon. Make sure **[NetBEUI]** is listed in the **[The following network components are installed]** box on the **[Configuration]** tab.

Note

- If NetBEUI is not installed, click **[Add]** on the **[Configuration]** tab to install it. For more information about installing NetBEUI, see Windows 95/98/Me Help.
- If **[NetBEUI →Dial-Up Adaptor]** is listed in the **[The following network components are installed]** box, select it, and then click **[Remove]** to remove the binding.

- 2** Click **[OK]** to close the **[Network]** dialog box.

Configuring a Windows 2000 Computer

Follow the procedure below to configure a Windows 2000 computer to use NetBEUI.

- 1** On the **[Start]** menu, point to **[Settings]**, and then click **[Network and Dial-up Connections]**.
- 2** Double-click **[Local Area Connection]**. On the **[General]** tab, click **[Properties]**.
- 3** Make sure **[NetBEUI Protocol]** is selected in the **[Components checked are used by this connection]** box on the **[General]** tab.

Note

- Select NetBEUI if it is not already selected.
- If NetBEUI is not installed, click **[Install]** on the **[General]** tab to install it. For more information about installing NetBEUI, see Windows 2000 Help.

- 4** Click **[OK]** to close the **[Local Area Connection]** dialog box.

Configuring a Windows NT 4.0 Computer

Follow the procedure below to configure a Windows NT 4.0 computer to use NetBEUI.

- 1** Open [Control Panel], and then double-click the Network icon. Make sure [NetBEUI Protocol] is listed in the [Network protocols] box on the [Protocols] tab.

 **Note**

- If NetBEUI is not installed, click [Add] on the [Protocols] tab to install it. For more information about installing NetBEUI, see Windows NT 4.0 Help.

- 2** Change the Lana Number. Click the [Services] tab, click [NetBIOS Interface] in the [Network services] box, and then click [Properties].

- 3** Click the Lana Number corresponding to the Nbf protocol in the [Network Route] column, and then click [Edit].

- 4** Enter "0" as the Lana Number.

 **Note**

- If the other protocol's Lana Number is "0", you must change the Lana Number to a number other than "0".

- 5** Click [OK].

- 6** Click [Close] to close the [Network] dialog box.

The confirmation message about restarting appears.

- 7** Click [Yes].

 **Note**

- After you change the Lana Number, you must restart the computer.

5. Using the Printer Function

This section contains instructions for configuring the machine as a network printer. Read the section that relates to your network environment for information about correct configuration.

❖ Printing with a Windows 2000/XP, Windows Server 2003, or Windows NT 4.0 Print Server

To set up the machine as a network printer in Windows 95/98/Me, Windows 2000/XP, Windows Server 2003, and Windows NT 4.0 environment, see p.45 “Printing with Windows”.

- Printing with a Windows 2000/XP, Windows Server 2003, or Windows NT 4.0 print server

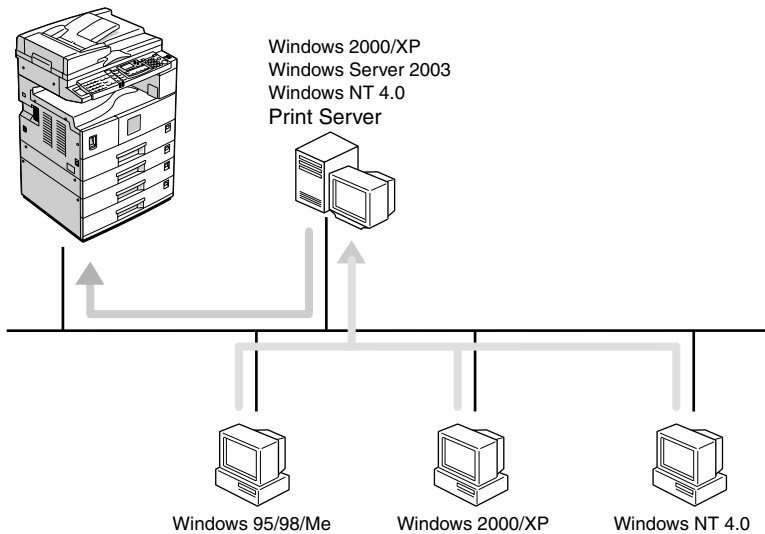

AAW00851

- Printing without a print server

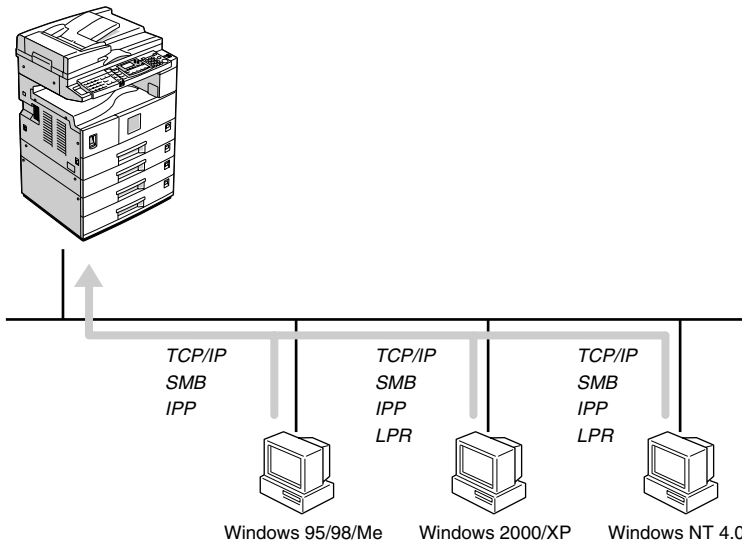

AAW009S1

5

Note

- Under Windows XP, you cannot print via NetBEUI using SMB.

❖ **Printing with a Macintosh**

To set up the machine as a network printer in a Macintosh environment, see p.49 “Printing with a Macintosh”.

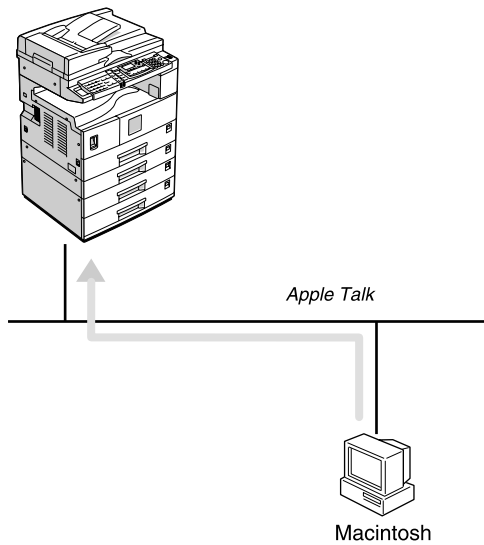

AAW010S1

❖ Printing with NetWare

To set up the machine as a print server or remote printer in a NetWare environment, see p.51 “Printing with NetWare”. The network interface board allows you to use the machine as either a print server or a remote printer.

- Configuring the machine as a print server

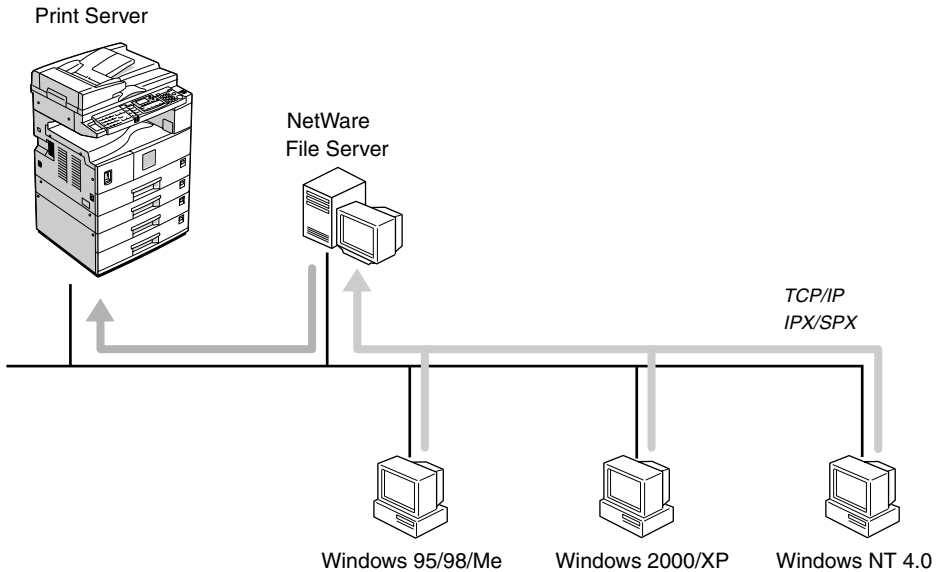

- Configuring the machine as a remote printer

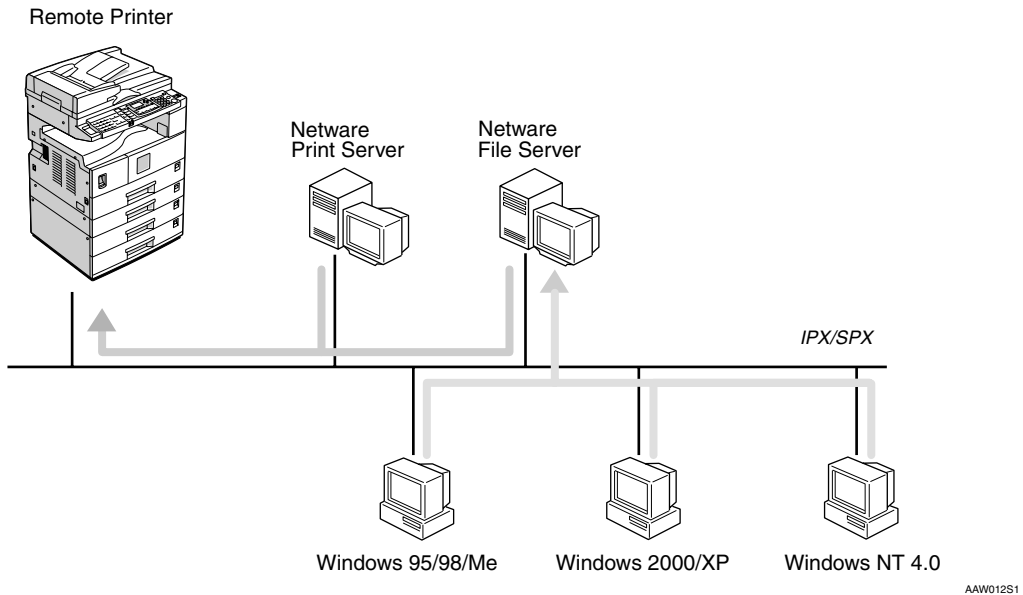

❖ **Printing with UNIX**

For UNIX printing information, visit our Web site or consult your authorized dealer.

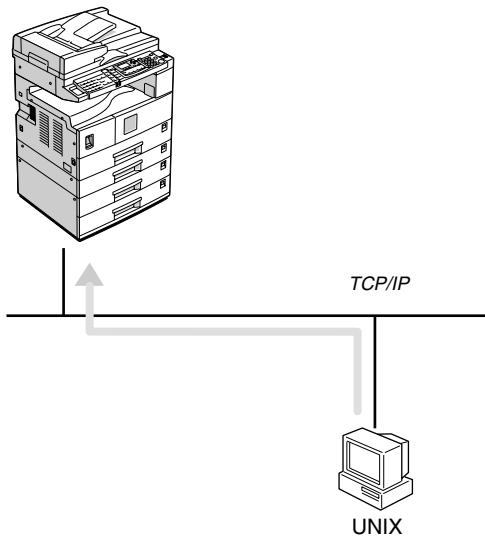

5

AAW013S1

Printing with Windows

Printing with a Windows 2000/XP, Windows Server 2003 or Windows NT 4.0 Print Server

This describes how to configure a client computer on a network using Windows 2000/XP, Windows Server 2003, Windows NT 4.0 Server or Windows NT 4.0 Workstation as a print server.

When using a Windows 2000/XP, Windows Server 2003, or Windows NT 4.0 print server, select a shared printer on Windows 2000/XP, Windows Server 2003, or Windows NT 4.0.

This section describes running **[Add Printer Wizard]** on each client computer, and adding the Windows 2000, Windows XP, Windows Server 2003, and Windows NT 4.0 print servers as the network printer.

These instructions are for Windows 98.

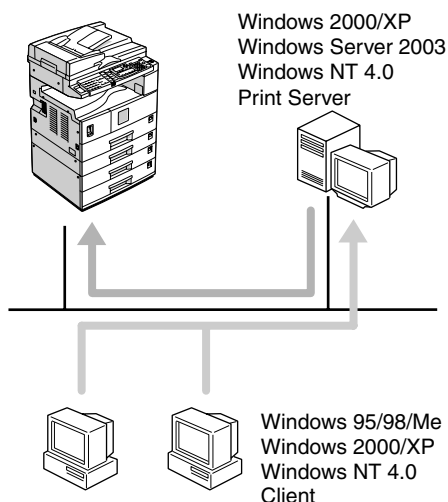

AAW014S1

Limitation

- When using a print server connected to the machine with SmartDeviceMonitor for Client, you cannot use Recovery Printing and Parallel Printing.
- When using Windows XP as a print server, the client computer cannot receive notification of print job completion.

Note

- This section assumes the client is already configured to communicate with a Windows 2000/XP, Windows Server 2003, or Windows NT 4.0 print server. Do not begin the following procedure until the client computer is set up and configured correctly.
- When using Windows NT 4.0 as the print server, make sure you install the Windows NT 4.0 printer driver before connecting the print server. There is a Windows NT 4.0 printer driver on the CD-ROM labeled "Printer Drivers and Utilities".

1 On the **[Start]** menu, point to **[Settings]**, and then click **[Printers]**.

2 Click the icon of the printer you want to use. On the **[File]** menu, click **[Properties]**.

3 Click the **[Details]** tab, and then click **[Add Port]**.

4 Click **[Network]**, and then click **[Browse]**.

- 5** On the network tree, double-click the name of the computer used as the print server.

The printers connected to the network are displayed.

- 6** Click the name of the printer you want to use, and then click [OK].

- 7** Click [OK].

- 8** Make sure the port name is displayed in the [Print to the following port] box, and then click [OK].

Printing without a Print Server

You can use this machine as a network printer without connecting to a print server.

You can configure the following ports:

❖ SmartDeviceMonitor

You can print via TCP/IP, IPP, or NetBEUI using SmartDeviceMonitor.

Note

- Install SmartDeviceMonitor for Client from the supplied CD-ROM. For more information about installation, see *Printer Reference 1*.
- For more information about SmartDeviceMonitor for Client, see p.63 "Using SmartDeviceMonitor for Client".

❖ Standard TCP/IP port

You can print via TCP/IP using a standard TCP/IP port.

Note

- A standard TCP/IP port can be used with Windows 2000/XP or Windows Server 2003.

❖ LPR port

You can print via TCP/IP using an LPR port.

Note

- An LPR port can be used with Windows 2000/XP, Windows Server 2003, or Windows NT 4.0.

Changing port settings

This describes how to change the port settings under Windows 2000 when a printer driver has been installed.

- 1** In the [Printers] window, click the icon of the printer you want to use. On the [File] menu, click [Properties].

- 2** Click the [Ports] tab, and then click [Add Port].

Select the port you want to use.

SmartDeviceMonitor

- 1** Click [SmartDeviceMonitor], and then click [New Port].

- 2** Select the printer you want to use.

❖ TCP/IP

- ① Click [TCP/IP], and then click [Search].
Available printers are listed.
- ② Click the printer you want to use, and then click [OK].

Note

- Printers that respond to a broadcast from the computer will be displayed. To print to a printer not listed here, click [Specify Address], and then enter the printer's IP address or host name.

❖ NetBEUI

✎ Note

- ❑ Do not use NetBEUI under Windows XP.
- ① Click **[NetBEUI]**, and then click **[Search]**.
Available printers are listed.
- ② Click the printer you want to use, and then click **[OK]**.

✎ Note

- ❑ Printers that respond to a broadcast from the computer will be displayed. To print to a printer not listed here, click **[Specify Address]**, and then enter the NetBEUI address. Confirm the NetBEUI address on the network appears on the configuration page. For more information about printing the configuration page, see *Printer Reference 2*. NetBEUI addresses appear as “\\RNPxxxx\xxx” on the configuration page. Enter the printer's network path name in the format: “%%Computer name\Share name”. Do not enter “\\” as head characters but “%%”.
- ❑ You cannot print to printers beyond routers.

❖ IPP

- ① Click **[IPP]**.
The IPP setting dialog box appears.
- ② To specify the IP address of the printer, enter “http://printer's IP address/printer” or “ipp://printer's IP address/printer” in the **[Printer URL]** box.
(Example: IP address is 192.168.15.16)
`http://192.168.15.16/printer`
`ipp://192.168.15.16/printer`
- ③ If necessary, enter the name to identify the printer in the **[IPP Port Name]** box. Enter a different name from those of any existing port name.
If you do not do this, the address entered in the **[Printer URL]** box is set as the IPP port name.
- ④ If a proxy server and IPP user name are used, click **[Detailed Settings]** and make the necessary settings.
- ⑤ Click **[OK]**.

Standard TCP/IP Port

- ① Click **[Standard TCP/IP]**, and then click **[New Port]**.
- ② In the **[Add Standard TCP/IP Printer Port Wizard]** dialog box, click **[Next]**.

- 3 In the [Printer Name or IP Address] box, enter the printer name or IP address, and then click [Next].
- 4 In the [Add Standard TCP/IP Printer Port Wizard] dialog box, click [Finish].

LPR Port

- 1 Click [LPR Port], and then click [New Port].
- 2 In the [Name or address of server providing lpd] box, enter the printer's IP address.
- 3 In the [Name of printer or print queue on that server] box, enter "lp", and then click [OK].

- 3 Click [OK].
- 4 Check the location for the selected printer, and click [Close].

Printing with a Macintosh

This describes how to configure a Macintosh computer to use EtherTalk. Actual procedures may vary depending on the version of the Mac OS. The following procedures describe how to configure Mac OS 9.1 and Mac OS X v10.1. If you are using other version than Mac OS 9.1 and Mac OS X v10.1, see the manual that comes with Mac OS for more information.

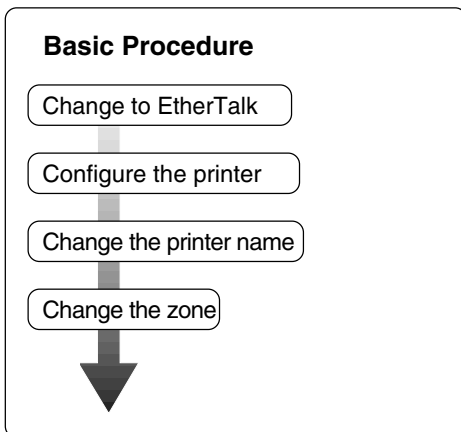

Note

- Mac OS 8.6 and later versions are supported (except for Mac OS X v10.0.x).
- To print from a Macintosh, PostScript 3 option is required.

Changing to EtherTalk

Follow the procedure below to configure a Macintosh computer to use EtherTalk.

Reference

For more information about installing the software required for EtherTalk, see the Macintosh manuals.

Mac OS

- 1** Open [Control Panel], and then double-click the AppleTalk icon.
- 2** On the [Connect via] pop-up menu, click [Ethernet].
- 3** If you change zones, select a name on the [Current zone] pop-up menu.
- 4** Close the [AppleTalk] control panel.
- 5** Click [Save].
- 6** Restart the Macintosh.

Mac OS X

Note

- You need an administrator name and a password (phrase). For more information, consult your administrator.

- 1** Open [System Preferences], and then click the Network icon.
- 2** From the [show] menu, select [Built-in Ethernet].
- 3** Click the [AppleTalk] tab.
- 4** If you change zones, select a name on the [AppleTalk Zone:] pop-up menu.
- 5** When the setting is complete, click [Apply Now].

Configuring the Printer

Use the control panel to activate the AppleTalk protocol. (The default is active.)

Reference

For more information about configuration, see p.26 “Interface Settings/Network”.

Changing the Printer Name

If the network has several similar model printers, the names will be the same. Printers with the same name will have slightly different names in the **[Chooser]** dialog box. For example, three printers named “printer” will appear in the **[Chooser]** dialog box as “printer0”, “printer1”, and “printer2”.

To change the printer name in the Macintosh EtherTalk environment, use Printer Utility for Mac included on the CD-ROM labeled “Printer Drivers and Utilities”.

Changing the Zone

To change the zone configuration in a Macintosh EtherTalk environment, use Printer Utility for Mac included on the CD-ROM labeled “Printer Drivers and Utilities”.

Reference

For more information about using Printer Utility for Mac, see *PostScript 3 Supplement*, provided as a PDF file on the CD-ROM labeled “Operating Instructions for Printer/Scanner”.

Printing with NetWare

This describes how to configure the machine for use as a print server or remote printer in a NetWare environment.

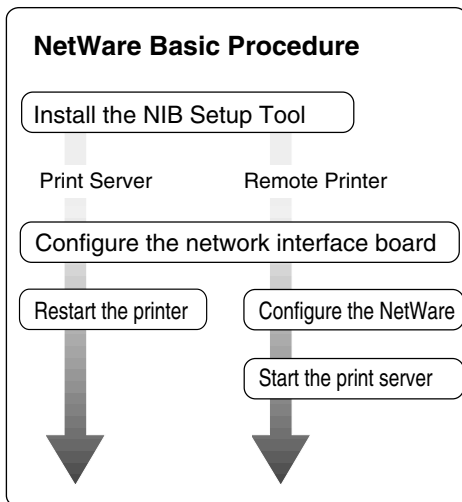

This section assumes NetWare is functional and the necessary environment for the NetWare print service is available.

Note

- NetWare must be set to active using the control panel. For more information about how to set it, see p.13 "Setting Up the Machine on a Network".

❖ SmartDeviceMonitor for Admin

To use a printer in a NetWare environment, configure the NetWare printing environment using SmartDeviceMonitor for Admin.

Note

- If you configure NetWare printing using SmartDeviceMonitor for Admin under the following environments, NetWare Client from Novell is required:
 - NDS mode in Windows 95/98/Me
 - NDS or Bindery mode in Windows 2000/XP, Windows Server 2003, Windows NT 4.0

❖ Printers listed by SmartDeviceMonitor for Admin

SmartDeviceMonitor for Admin displays a list of printers that are connected to the network.

If you cannot find the printer from the displayed list, refer to the configuration page printed from the machine. For more information about printing a configuration page, see *Printer Reference 2*.

Setting Up as a Print Server

NetWare 3.x

1 Log on to the file server as a Supervisor, or equivalent.

2 Start **SmartDeviceMonitor** for Admin.

3 On the **[Group]** menu, point to **[Search Device]**, and then click **[IPX/SPX]**.

A list of machines appears.

4 In the list, select the printer for which you want to change configuration.

5 On the **[Tools]** menu, click **[NIB Setup Tool]**.

NIB Setup Tool starts.

6 Click **[Wizard]**, and then click **[OK]**.

7 If necessary, enter the print server name in the **[Device Name:]** box, and then click **[Next >]**.

8 Select the **[NetWare]** check box, and then click **[Next >]**.

9 Click **[Bindery Mode]**, enter the file server name in the **[File Server Name:]** box, and then click **[Next >]**.

- In the **[File Server Name:]** box, enter the file server name (up to 47 alphanumeric characters) of the server to make the print server. You can also click **[Browse...]** to select a file server in the **[Browse...]** dialog box.

10 Enter the print server name in the **[Print Server Name:]** box, the printer name in the **[Printer Name:]** box, and the print queue name in the **[Print Queue Name:]** box, then click **[Next >]**.

- In the **[Print Server Name:]** box, enter the name of the NetWare print server using up to 47 characters.
- In the **[Printer Name:]** box, enter the name of the NetWare printer using up to 47 characters.
- In the **[Print Queue Name:]** box, enter the name of the print queue to be added to NetWare.

11 After confirming the settings, click **[Next >]**.

The settings take effect, and NIB Setup Tool closes.

12 Quit **SmartDeviceMonitor** for Admin.

13 Restart the printer.

Note

- To make sure the printer is correctly configured, enter the following from the command prompt:

```
F:> USERLIST
```

- If the printer works as configured, the name of the print server appears as an attached user.

NetWare 4.x, 5/5.1, 6

Important

- ❑ You must set up the print server using NDS mode in NetWare 4.x, 5/5.1, 6.

❖ To use NetWare 5/5.1, 6

- Use the printer as a print server. Do not use it as a remote printer in a PureIP environment.
- If you use PureIP, configure the machine to use TCP/IP. For more information about how to make the settings, see p.13 “Setting Up the Machine on a Network”.

1 Log on to the file server as an administrator, or equivalent.

2 Start SmartDeviceMonitor for Admin.

3 On the [Group] menu, point to [Search Device], and then click [IPX/SPX] or [TCP/IP].

A list of machines appears.

4 In the list, select the printer for which you want to change configuration.

5 On the [Tools] menu, click [NIB Setup Tool].

NIB Setup Tool starts.

Reference

If you use NetWare 5/5.1 or NetWare 6 in a PureIP environment, see p.54 “Using PureIP in the NetWare 5/5.1, 6 environment”.

6 Click [Wizard], and then click [OK].

7 If necessary, enter the print server name in the [Device Name:] box, and then click [Next >].

8 Select the [NetWare] check box, and then click [Next >].

9 Click [NDS Mode:], enter the file server name in the [File Server Name:] box, the NDS tree name in the [NDS Tree:] box and the context in the [NDS Context:] box, and then click [Next >].

- In the [File Server Name:] box, enter the file server name (up to 47 alphanumeric characters) of the server to make the print server. You can also click [Browse...] to select a file server in the [Browse...] dialog box.
- In the [NDS Tree:] box, enter the NDS tree name (using up to 32 alphanumeric characters (“-” and “_” can be used)) of the NDS tree in which you want to make the print server. [Browse...] to select an NDS tree from those listed in the [Browse...] dialog box.
- In the [NDS Context:] box, enter the NDS context in which to make the print server. As context, object names are entered in lower object order and divided by a period. For example, if you want to create a print server in NET under DS, enter “NET.DS”.



10 Enter the print server name in the [Print Server Name:] box, the printer name in the [Printer Name:] box, the print queue name in the [Print Queue Name:] box, and the print queue volume in the [Queue Volume:], and then click [Next >].

- In the [Print Server Name:] box, enter the name of the NetWare print server using up to 47 characters.
- In the [Printer Name:] box, enter the name of the NetWare printer using up to 47 characters.
- In the [Print Queue Name:] box, enter the name of the print queue to be added to NetWare.
- In [Queue Volume:], enter the print queue volume. As a volume, object names are entered from a lower object and divided by a period. You can also click [Browse...] to select a volume in the [Browse...] dialog box.

11 After confirming the settings, click [Next >].

12 Click [Finish].

The settings take effect, and NIB Setup Tool closes.

13 Quit SmartDeviceMonitor for Admin.

14 Restart the printer.

 **Note**

- To make sure the printer is correctly configured, enter the following from the command prompt:

```
F:>NLIST USER /A/B
```

- If the printer works as configured, the name of the print server appears as an attached user.

Using PureIP in the NetWare 5/5.1, 6 environment

 **Note**

- When not using IPX, it is recommended that you change the print server protocol in the Web browser from [TCP/IP+IPX] to [TCP/IP].

1 Log on to the file server as an administrator, or equivalent.

2 Start SmartDeviceMonitor for Admin.

3 On the [Group] menu, point to [Search Device], and then click [IPX/SPX].

A list of machines appears.

4 In the list, select the printer for which you want to change configuration.

5 On the [Tools] menu, click [NIB Setup Tool].

NIB Setup Tool starts.

6 Click [Property Sheet], and then click [OK].

7 If necessary, enter the print server name in the [Device Name:] box.

8 Click the [NetWare] tab, and then make the following settings:

- 1** In the [Logon Mode] area, click [File Server Mode] or [NDS Mode:].

 **Note**

- If [File Server Mode] is selected, a connecting destination will be chosen based on the string entered in step **3**.
- If [NDS Mode:] is selected, a connecting destination will be chosen based on the string entered in step **4**.

- ② In the [Print Server Name:] box, enter the print server name.

! **Limitation**

- Enter up to 47 alphanumeric characters.

- ③ In the [File Server Name:] box, enter the name of the file server in which the print server is to be created.

By clicking [Browse...], you can select a file server among those listed in the [Browse...] dialog box.

! **Limitation**

- Enter up to 47 alphanumeric characters.

- ④ In the [NDS Tree:] box, enter the NDS tree name in which to make the file server.

By clicking [Browse...], you can select the NDS tree name and NDS context name from their lists.

! **Limitation**

- Enter up to 32 alphanumeric characters (“-” and “_” can be used).

- ⑤ In the [NDS Context:] box, enter the context of the print server.

! **Limitation**

- Enter up to 127 alphanumeric characters.

 **Note**

- As context, object names are entered in lower object order and divided by a period. For example, if you want to create a print server into NET under d, enter “d”.

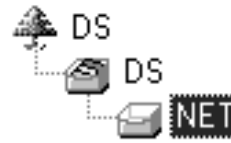

- ⑥ In the [Print Server Operation Mode] area, click [As Print Server].

- ⑦ Click [OK] to close the [NIB Set-up Tool - Network board list] dialog box.

- ⑧ **Quit SmartDeviceMonitor for Admin.**

After this step, operate the machine by following the procedure from step ⑨ on p.58 “NetWare 4.x, 5/5.1, 6”. However, steps ⑩-③ and ⑩-④ are not required.

Setting Up as a Remote Printer

NetWare 3.x

1 Log on to the file server as an administrator, or equivalent.

2 Start SmartDeviceMonitor for Admin.

3 On the [Group] menu, point to [Search Device], and then click [IPX/SPX].

A list of machines appears.

4 In the list, select the printer for which you want to change configuration.

5 On the [Tools] menu, click [NIB Setup Tool].

NIB Setup Tool starts.

6 Click [Property Sheet], and then click [OK].

The [NIB Setup Tool - Network board list] dialog box appears.

7 Click the [NetWare] tab, and then make the following settings:

1 In the [Print Server Name:] box, enter the name of the print server.

⚠ Limitation

Enter up to 47 alphanumeric characters.

2 In the [File Server Name:] box, enter the name of the file server in which a print server is to be created.

By clicking [Browse...], you can select a file server among those listed in the [Browse...] dialog box.

⚠ Limitation

Enter up to 47 alphanumeric characters.

3 In the [Print Server Operation Mode] area, click [As Remote Printer].

4 In the [Remote Printer No.] box, enter the printer number.

⚠ Important

Use the same printer number as that to be created in the print server.

5 Click [OK] to close the [NIB Setup Tool - Network board list] dialog box.

8 Quit SmartDeviceMonitor for Admin.

9 Enter "PCONSOLE" from the command prompt.

```
F: > PCONSOLE
```

10 Create a print queue as follows:

📝 Note

If you are using a currently defined print queue, proceed to step **11**.

1 On the [Available Options] menu, click [Print Queue Information], and then press the [ENTER] key.

2 Press the [INSERT] key, and then enter a print queue name.

3 Press the [ESCAPE] key to return to the [Available Options] menu.

11 Create a printer as follows:

1 On the [Available Options] menu, click [Print Server Information], and then press the [ENTER] key.

- 2 To create a new print server, press the **[INSERT]** key, and then enter a print server name.

 **Note**

- If you are using a currently defined print server, select one of the print servers shown in the **[Print Server]** list.

 **Important**

- Use the same name as that specified in NIB Setup Tool. (Step **7-1**).
- 3 On the **[Print Server Information]** menu, click **[Print Server Configuration]**.
 - 4 On the **[Print Server Configuration]** menu, click **[Printer Configuration]**.
 - 5 Select the printer indicated as "Not Installed".

 **Important**

- Use the same number as that specified as the Remote Printer No. using NIB Setup Tool. (Step **7-4**).
- 6 If you want to change the printer name, enter a new name.

 **Note**

- The name "Printer x" is assigned to the printer. "x" stands for the number of the selected printer.

- 7 Click **[Remote Parallel, LPT1]** as the printer type.

IRQ, Buffer size, Starting form, and Queue service mode are automatically configured.

- 8 Press the **[ESC]** key, and then click **[Yes]** when the confirmation message appears.

- 9 Press the **[ESC]** key to return to the **[Print Server Configuration]** menu.

- 12 Assign print queues to the created printer as follows:

- 1 On the **[Print Server Configuration]** menu, click **[Queues Serviced By Printer]**.
- 2 Select the printer created in step **11**.
- 3 Press the **[INSERT]** key to select a queue serviced by the printer.

 **Note**

- You can select more than one queue at a time.

- 4 Follow the instructions on screen to make other necessary settings.

When you have finished the above procedure, make sure the queues are assigned.

- 13 Press the **[ESC]** key until the "Exit?" appears, and then click **[Yes]** to quit PCONSOLE.

- 14 Start the print server by entering the following from the NetWare server's keyboard.

If it is running, restart after quitting.

❖ **To quit**

```
CAREE: unload pserver
```

❖ **To start**

```
CAREE: load pserver
print_server_name
```

 **Note**

- If the printer works as configured, "Waiting for job" appears.
- NetWare 3.x ends here.

NetWare 4.x, 5/5.1, 6

1 Log on to the file server as an administrator, or equivalent.

2 Start SmartDeviceMonitor for Admin.

3 On the [Group] menu, point to [Search Device], and then click [IPX/SPX].

A list of machines appears.

4 In the list, select the printer for which you want to change configuration.

5 On the [Tools] menu, click [NIB Setup Tool].

NIB Setup Tool starts.

6 Click [Property Sheet], and then click [OK].

The [NIB Setup Tool - Network board list] dialog box appears.

7 Click the [NetWare] tab, and then make the following settings:

1 In the [Logon Mode] area, select [File Server Mode] or [NDS Mode:].

 **Note**

If [File Server Mode] is selected, a connecting destination will be chosen based on the string entered in step **3**.

If [NDS Mode:] is selected, a connecting destination will be chosen based on the string entered in step **4**.

2 In the [Print Server Name:] box, enter the name of the print server.

 **Important**

Use the same name as that of the print server name to be set from NWadmin (**18-3**).

 **Limitation**

Enter up to 47 alphanumeric characters.

3 In the [File Server Name:] box, enter the name of the file server in which a print server is to be created.

By clicking [Browse...], you can select a file server among those listed in the [Browse...] dialog box.

 **Limitation**

Enter up to 47 alphanumeric characters.

4 In the [NDS Tree:] box, enter the NDS tree name in which to make the file server.

By clicking [Browse...], you can select the NDS tree name and NDS context name from their lists.

 **Limitation**

Enter up to 32 alphanumeric characters ("-" and "_" can be used).

5 In the [NDS Context:] box, enter the context in which the print server is to be created.

 **Limitation**

Enter up to 127 alphanumeric characters.

6 In the [Print Server Operation Mode] area, click [As Remote Printer].

7 In the [Remote Printer No.] box, enter the number of the printer.

 **Important**

Use the same number as that of the printer to be created in the print server (**17-4**).

8 Click [OK] to close the [NIB Setup Tool - Network board list] dialog box.

8 Quit SmartDeviceMonitor for Admin.

9 On Windows, start NWadmin.

Reference

For more information about NWadmin, see the operating instructions that come with the NetWare.

10 Create a print queue as follows:

Note

If you are using a currently defined print queue, proceed to step 11.

1 Select the container object the print queue is located in from those in the directory tree, and then click [Create] on the [Object] menu.

2 In the [Class of new object] box, click [Print Queue], and then click [OK].

3 In the [Print Queue name] box, enter the name of the print queue.

4 In the [Print Queue Volume] box, click [Browse].

5 In the [Available objects] box, click the volume in which the print queue is created, and then click [OK].

6 After checking the settings, click [Create].

11 Create a printer as follows:

1 Select the container object where the printer is located, and then click [Create] on the [Object] menu.

2 In the [Class of new object] box, click [Printer], and then click [OK]. If you are using NetWare 5/5.1, 6, click [Printer (Non NDPS)].

3 In the [Printer name] box, enter the name of the printer.

4 Select the [Define additional properties] check box, and then click [Create].

12 Assign print queues to the created printer as follows:

1 Click [Assignments], and then click [Add] in the [Assignments] area.

2 In the [Available objects] box, click the queue created in step 11, and then click [OK].

3 Click [Configuration], and in the [Printer type] list, click [Parallel], and then click [Communication].

4 In the [Communication type] area, click [Manual load], and then click [OK].

5 After checking the settings, click [OK].

13 Create a print server as follows:

1 Select the context specified using NIB Setup Tool (Step 7-2), and on the [Object] menu, click [Create].

2 In the [Class of new object] list, click [Print Server], and then click [OK].

If you are using NetWare 5/5.1, 6, click [Print Server (Non NDPS)].

3 In the [Print Server name] box, enter the name of the print server.

Important

Use the same name as that specified using NIB Setup Tool (step 7-2).

- ④ Select the [Define additional properties] check box, and then click [Create].
- 14 Assign the printer to the created print server as follows:
 - ① Click [Assignments], and then click [Add] in the [Assignments] area.
 - ② In the [Available objects] box, click the queue created in step 10, and then click [OK].
 - ③ In the [Printers] box, click the printer assigned in step ②, and then click [Printer Number].
 - ④ Enter the printer number, and then click [OK].
- ❗ **Important**
 - Use the same number as that specified as Remote Printer No. using NIB Setup Tool (step 7-7).
- ⑤ After checking the settings, click [OK].
- 15 Start the print server by entering the following from the NetWare server's keyboard.

If it is running, restart after quitting.

❖ **To quit**

```
CAREE: unload pserver
```

❖ **To start**

```
CAREE: load pserver
print_server_name
```

Setting Up a Client Computer

This describes how to set up a client computer when using a NetWare print server.

 **Note**

- Use the version of Novell Client provided with your operating system, or the latest version.
- This section assumes the client computer has NetWare client applications installed and is correctly configured to communicate with a NetWare print server. If it is not, install the necessary applications before starting the setting up procedure.

Windows 95/98/Me

Follow the procedure below to set up a Windows 95/98/Me client computer:

 **Preparation**

Log on to the NetWare file server before starting the following procedure:

- 1 Install the printer driver you want to use as "local printer".

 **Reference**

For more information about installing the printer driver, see *Printer Reference 1*.

 **Note**

- Any port can be selected during installation. However, LPT1 is recommended.
- 2 On the [Start] menu, point to [Settings], and then click [Printers].
 - 3 In the [Printers] window, click the icon of the printer you want to use.

- 4 On the [File] menu, click [Properties].
- 5 Click the [Details] tab, and then click [Add Port].
- 6 Click [Network], and then click [Browse].
- 7 In the tree pane, double-click the name of the file server.
The queues are displayed.
- 8 Select the queue you want to print, and then click [OK].
- 9 Click [OK].
In the [Print to the following port] box, a network path to the printer appears.
- 10 Click [OK] to close the printer properties dialog box, and open it again.
- 11 Click the [Printer Settings] tab.
- 12 Clear the [Form feed] and [Enable banner] check boxes.

 **Note**

- You do not have to select these boxes because they should be specified in the printer driver. If they are selected, the printer might not print correctly.

When using the PostScript printer driver

Follow the procedure below to set the PostScript printer driver:

- 1 Click the [PostScript] tab.
- 2 Click [Advanced].
- 3 Clear the [Send CTRL+D before job] and [Send CTRL+D after job] check boxes.

- 13 Click [OK] to close the printer properties dialog box.

Windows 2000/XP, Windows NT 4.0

Follow the procedure below to set up a Windows 2000/XP, Windows NT 4.0 client computer.

 **Preparation**

Log on to the NetWare file server before starting the following procedure:

- 1 Double-click [My Network Places], navigate to the queue you want to use, and then double-click it.

The [Printers] dialog box appears.

 **Note**

- When using Windows NT 4.0, the Network Neighborhood icon appears on the desktop instead of the My Network Places icon.

- 2 Click [Yes], and then click [OK].

Add Printer Wizard starts.

- 3 Insert the CD-ROM labeled "Printer Drivers and Utilities" into the CD-ROM drive, and then click [Have Disk].

If the setup menu starts automatically, you can proceed to the next step. If not, see *Printer Reference 1*.

- 4 Follow the instructions on screen to complete installation of the printer driver.

 **NDPS**

The machine operates using NDPS. Operating requirements are as follows:

- NetWare Version: 5/5.1, 6

❖ **Printer Drivers and Operating Systems**

Printer driver	Operating system
PCL	Windows 95/98/Me Windows 2000 Windows XP Professional Windows NT 4.0
PostScript 3	Windows 95/98/Me Windows 2000 Windows XP Professional Windows NT 4.0

To use the machine with NDPS, NDPS Gateway is required.

- **Novell NDPS Gateway**
For more information about using Novell NDPS Gateway, see the manual provided with it.
- **Custom NDPS Gateway**
For more information about using Custom NDPS Gateway, consult your authorized retailer.

 **iPrint**

This machine does not support iPrint.

6. Using SmartDeviceMonitor for Client

SmartDeviceMonitor for Client

SmartDeviceMonitor for Client is equipped with the following functions. We recommend all users of this printer to install this software.

❖ Protocol Stack

Operating system	Protocol stack
Microsoft Windows 95/98/Me	TCP/IP provided with Windows 95/98/Me IPX/SPX provided with Windows 95/98/Me NetBEUI provided with Windows 95/98/Me NetWare network client provided with Windows 95/98/Me Novell Client for Windows 95/98/Me
Microsoft Windows 2000	TCP/IP provided with Windows 2000 IPX/SPX provided with Windows 2000 NetBEUI provided with Windows 2000 NetWare Client provided with Windows 2000 Novell Client for Windows NT/2000/XP
Microsoft Windows XP	TCP/IP provided with Windows XP IPX/SPX provided with Windows XP NetWare Client provided with Windows XP Novell Client for Windows NT/2000/XP
Microsoft Windows Server 2003	TCP/IP provided with Windows Server 2003 IPX/SPX provided with Windows Server 2003
Microsoft Windows NT 4.0	TCP/IP provided with Windows NT 4.0 IPX/SPX provided with Windows NT 4.0 NetBEUI provided with Windows NT 4.0 Client Service for NetWare provided with Windows NT 4.0 Novell Client for Windows NT/2000/XP

❖ What can it do?

- Peer-to-Peer print function
 - Print directly on the network printer without a print server.
 - Print on a substitute printer if too many jobs accumulate in the specified printer, or if an error disables printing (Recovery Printing).
 - Allocate multiple printings to multiple printers (Parallel Printing).
 - Perform prior group registration of printers specified for Recovery Printing /Parallel Printing.

- Notification function
 - An error message appears if there is an error on the specified printer during transfer or printing of data.
 - A window opens to notify you of print completion. You can also select to be notified of the print condition, such as displaying the notice only when Recovery Printing is executed.
 - A completion message appears after printing, document storage, and LAN-Fax transmission.
- Display an error message if an error occurs during printing or transmission of a print job.
- Monitoring function
 - Check the equipment to give you information about printing, paper levels, etc., via your computer.
 - Simultaneously monitor multiple printers in use.
 - Check the printer's network settings and detailed information of devices.
 - Check the print job log using the user ID.
- Receive the reports of print completion and document storage using the printer function, and print completion, document storage and transmission by the LAN-Fax function.
- Display up to 100 print jobs.

Limitation

- Make the same settings for the option configuration of the printer for Recovery/Parallel Printing and the printer for giving print commands. If the options necessary for printing, such as the paper feed unit, are not installed on the substitute printer, that function is disabled.
- Load paper of the same size on both the printer for Recovery/Parallel Printing and the printer for giving print commands. When specifying a particular paper tray for printing, load paper of the same size into that tray.
- If the type and devices of the printer for Recovery/Parallel Printing and the printer for giving commands are different, print results might not be identical.
- If you select Sample Print or Locked Print, you cannot execute Recovery/Parallel Printing.

Reference

For more information about using Recovery Printing/Parallel Printing, see SmartDeviceMonitor for Client Help.

Setting the Network Monitoring Function

To view the status of machines using SmartDeviceMonitor for Client, you must configure SmartDeviceMonitor for Client in advance, so that it monitors the machine whose status you want to view.

1 Start SmartDeviceMonitor for Client.

The SmartDeviceMonitor for Client icon appears at the right end of the taskbar.

2 Right-click the SmartDeviceMonitor for Client icon, and check the desired machine is on the shortcut menu that appears.

For details about the machine status icon, see SmartDeviceMonitor for Client Help.

3 If the desired machine does not appear, click [Options...] on the shortcut menu.

The [SmartDeviceMonitor for Client - Options] dialog box appears.

4 Select the machine to be monitored, and select the [To be Monitored] check box.

 **Note**

- Selecting the [Displayed on Task Bar] check box will bring up the status of a machine on the SmartDeviceMonitor for Client icon on the taskbar.

5 Click [OK].

The dialog box closes and the selected machine is monitored.

Displaying the Status of Machines

Follow the procedure below to monitor machine status using SmartDeviceMonitor for Client.

1 Start SmartDeviceMonitor for Client.

2 The status of machines is displayed on the SmartDeviceMonitor for Client icon on the taskbar.

 **Note**

- For more information about status icons, see SmartDeviceMonitor for Client Help.

3 For further information on status, right-click the SmartDeviceMonitor for Client icon, and then select the desired machine.

The status of the machine is displayed in the dialog box.

 **Note**

- For more information about each item in the dialog box, see SmartDeviceMonitor for Client Help.

7. Using SmartDeviceMonitor for Admin

SmartDeviceMonitor for Admin

Using SmartDeviceMonitor for Admin, not only can you monitor the status of network printers, but you can also change the configuration of the network interface board using TCP/IP or IPX/SPX protocol.

❖ Protocol Stack

Operating system	Protocol stack
Microsoft Windows 95/98/Me	TCP/IP provided with Windows 95/98/Me IPX *1 /SPX provided with Windows 95/98/Me NetWare network client provided with Windows 95/98/Me Novell Client for Windows 95/98/Me
Microsoft Windows 2000	TCP/IP provided with Windows 2000 IPX *1 /SPX provided with Windows 2000 NetWare Client provided with Windows 2000 Novell Client for Windows NT/2000/XP
Microsoft Windows XP	TCP/IP provided with Windows XP IPX *1 /SPX provided with Windows XP Novell Client for Windows NT/2000/XP
Microsoft Windows Server 2003	TCP/IP provided with Windows Server 2003 IPX *1 /SPX provided with Windows Server 2003 NetWare Client provided with Windows Server 2003
Microsoft Windows NT 4.0	TCP/IP provided with Windows NT 4.0 IPX *1 /SPX provided with Windows NT 4.0 Client Service for NetWare provided with Windows NT 4.0 Novell Client for Windows NT/2000/XP

*1 IPX is used for monitoring the machines.

❖ What can it do?

- Limit settings done from the control panel, and disable changes made to certain items.
- Select of paper type loaded in the machine.
- Switch to, and come out of Energy Saver mode.
- Check information about printing, paper quantity, etc.
- Simultaneously monitor multiple printers. When there are many printers, you can create groups and classify printers to facilitate management.

- Check the machine's network settings and detailed device information.
- Change the machine's network settings.
- Check details of print jobs sent from a computer.
- Check job histories of printed, faxed (LAN-Fax), scanned, and photocopied documents identified by user codes.
- Select functions such as printing and scanning for each user code.
- Change and save numbers and e-mail addresses stored in the machine by computer.
- Check each fax job history entry.
- Check settings for and display the status changes of group devices.
- Using Address Management Tool, manage LAN-Fax numbers, and addresses for sending and receiving Internet faxes.
- Protect the e-mail sender's name and folder.

Reference

For more information about these settings, see SmartDeviceMonitor for Admin Help.

Limitation

TCP/IP is required for the following functions:

- Using Tools
 - Locking the Control Panel Menu
 - Selecting the Paper Type
 - Managing User Information
 - Address Management Tool
 - Loading Fax Journal
 - Starting the Web browser using SmartDeviceMonitor for Admin

Changing the Network Interface Board Configuration

Limitation

- Internet Explorer 4.01 or a later version is required to use NIB Setup Tool.

1 Start SmartDeviceMonitor for Admin.

2 On the [Group] menu, point to [Search Device], and then click [TCP/IP] or [IPX/SPX].

A list of machines appears.

Note

- Select the protocol of the machine for which you want to change configuration.

3 In the list, select the machine for which you want to change configuration.

4 On the [Tools] menu, click [NIB Setup Tool].

NIB Setup Tool starts.

5 Click [Property Sheet], and then click [OK].

6 Change the device name and comment.

7 Click [OK].

Confirmation message appears.

8 Click [OK].

Note

- For more information about changing machine names, comments, and other items, see NIB Setup Tool Help.

Displaying Machine Status

Follow the procedure below view the status of machines using SmartDeviceMonitor for Admin.

1 Start SmartDeviceMonitor for Admin.

2 On the [Group] menu, point to [Search Device], and then click [TCP/IP] or [IPX/SPX].

The status of machines is indicated by an icon in the list.

Note

- For more information about status icons, see SmartDeviceMonitor for Admin Help.

3 For further information, select the desired machine in the list, and then click [Open] on the [Device] menu.

The status of the machine is displayed in the dialog box.

Note

- For more information about each item in the dialog box, see SmartDeviceMonitor for Admin Help.

Locking the Control Panel Menu

- 1** Start SmartDeviceMonitor for Admin.
- 2** On the [Group] menu, point to [Search Device], and then click [TCP/IP] or [IPX/SPX].

A list of machines appears.

Note

- Select the protocol of the machine for which you want to change configuration.

- 3** In the list, select the machine for which you want to change configuration.

- 4** On the [Tools] menu, point to [Device Settings], and then click [Lock Operation Panel Menu].

The dialog box for entering the password appears.

- 5** Enter your user name and password, and then click [OK].

Note

- To use the factory default account, enter no user name and enter "password" for the password.

- 6** On "Lock Printer Operation Panel", click [Enable], and then click the Apply icon.

Reference

For more information about viewing status information and changing settings using a Web browser, see Help on the Web browser.

Selecting the Paper Type

- 1** Start SmartDeviceMonitor for Admin.

- 2** On the [Group] menu, point to [Search Device], and then click [TCP/IP] or [IPX/SPX].

A list of machines appears.

Note

- Select the protocol of the machine for which you want to change configuration.

- 3** In the list, select the machine for which you want to change configuration.

- 4** On the [Tools] menu, point to [Device Settings], and then click [Select Paper Type].

The dialog box for entering the password appears.

- 5** Enter your user name and password, and then click [OK].

Note

- To use the factory default account, enter no user name and enter "password" for the password.

Check the paper type on the Web browser, and make the paper settings.

Reference

For more information about viewing status information and changing settings using a Web browser, see Help on the Web browser.

Managing User Information

1 Start SmartDeviceMonitor for Admin.

2 On the [Group] menu, point to [Search Device], and then click [TCP/IP] or [IPX/SPX].

A list of machines appears.

 **Note**

- Select the protocol of the machine for which you want to change configuration.

3 In the list, select the machine for which you want to change configuration.

4 On the [Tools] menu, click [User Management Tool].

The dialog box for entering the password appears.

5 Enter the password, and then click [OK].

 **Note**

- The factory default password is “password”.

User Management Tool starts.

For more information about using User Management Tool, see User Management Tool Help.

Loading Fax Journal

1 Start SmartDeviceMonitor for Admin.

2 On the [Group] menu, point to [Search Device], and then click [TCP/IP] or [IPX/SPX].

A list of machines appears.

 **Note**

- Select the protocol of the machine for which you want to change configuration.

3 In the list, select the machine for which you want to change configuration.

4 On the [Tools] menu, click [Load Fax Journal].

5 Check the Load Fax Journal area that appears in the Web browser, and change the settings.

For details, see Help on the Web browser.

Managing Address Information

1 Start SmartDeviceMonitor for Admin.

2 On the [Group] menu, point to [Search Device], and then click [TCP/IP] or [IPX/SPX].

A list of machines appears.

Note

- Select the protocol of the machine for which you want to change configuration.

3 In the list, select the machine for which you want to change configuration.

4 On the [Tools] menu, click [Address Management Tool].

The dialog box for entering the password appears.

5 Enter the password, and then click [OK].

Note

- The factory default password is “password”.

Address Management Tool starts.

Reference

For more information about Address Management Tool, see Address Management Tool Help.

Configuring Energy Saver Mode

1 Start SmartDeviceMonitor for Admin.

2 On the [Group] menu, point to [Search Device], and then click [TCP/IP] or [IPX/SPX].

A list of machines appears.

3 On the [Group] menu, point to [Energy Saver Mode].

For more information about the Energy Saver Mode settings, see SmartDeviceMonitor for Admin Help.

Note

- Point to [Set by Group] if you want to change all devices in the area.
- Point to [Set Individually] if you want to change only selected devices.
- When you point to [Set Individually], [Timer Settings] is not displayed.

8. Configuring the Network Interface Board Using a Web Browser

You can check the status of a machine and change its settings using the Web browser.

❖ What can it do?

You can remotely check the status of a machine or specify its settings over the network using a computer's Web browser.

The following functions are available with Web browser:

- Displaying machine status/settings
- Checking print job status and history, or deleting the print job
- Managing the Address Book
- Making machine settings

❖ Configuring the machine

This requires TCP/IP to be installed. After the machine has been configured to use TCP/IP, it will be possible to adjust settings using a Web browser.

Reference

For more information about configuring the machine to use TCP/IP, see p.13 "Setting Up the Machine on a Network".

❖ Browser

- Windows
 - Microsoft Internet Explorer 5.5 or later
 - Netscape Navigator 6.2 or later
- Macintosh
 - Netscape Navigator 6.2 or later

Limitation

- If the Web browser in use is older than the recommended version or **[JavaScript]** and **[Cookie]** are not available, display and operation problems may occur.
- If you are using a proxy server, change the Web browser settings. Consult your network administrator about the settings.
- Sometimes after clicking **[Back]**, the previous page may not appear. In this case, click **[Refresh]** or **[Reload]**.
- This machine information cannot be refreshed automatically. Click **[Reload]** or **[Refresh]** on the Web browser, or click **[Refresh]** on the work area when you want to refresh the machine information.

❖ Specifying the address

In the **[Address]** box, enter the address (for example `http://XXX.XXX,XXX,XXX`, where the Xs are the numbers of the IP address).

If the host name of the machine is registered on the DNS server or WINS server, you can enter it.

Going to the Top Page

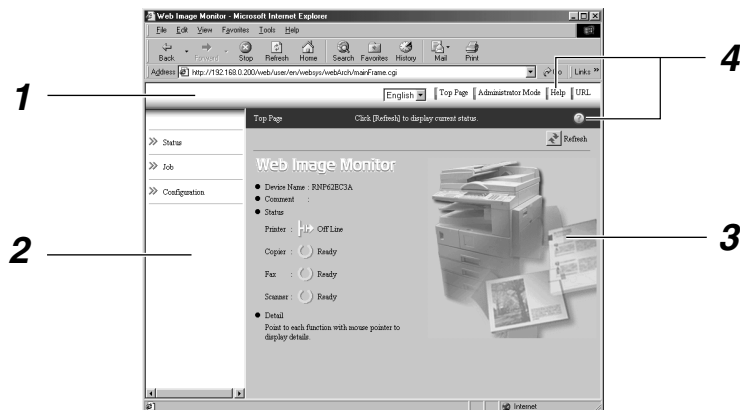

1. Header area

You can register favorite URLs using [URL]. To view the Help section, click [Help].

2. Menu area

These menus are for configuring the network interface board and checking machine status.

3. Status

Displays machine status, network interface board name, and comments.

4. Help

To view the Help section, click [Help].

Types of Menu Configuration and Mode

Items that appear on the menu area differ between user mode and administrator mode.

The work area which appears under the selected menu displays machine status under user mode and machine status and settings under administrator mode.

Note

- Indicates machine status can be displayed.
- Indicates machine settings can be changed.

Menu		User mode	Administrator mode	
Status	Input Tray		○	○
	Output Tray		○	○
	Toner		○	○
	Function		○	○
	System		○	○
	Printer Language		○	○
Job	Printer	Job History	○	○
		Error Log	○	○
	Fax History	Transmission	○	○
		Reception	○	○
		LAN-Fax	○	○
Address Book		-	●	

Menu			User mode	Administrator mode	
Configura- tion	Paper		-	●	
	System		-	●	
	Fax	General	○	●	
		Key Operator Tools	-	●	
		Parameter Settings	-	●	
	Printer		○	●	
	E-mail		○	●	
	Interface		○	● ^{*1}	
	Network	Protocol	Protocol	○	●
			TCP/IP	○	●
			NetWare	○	●
			AppleTalk	○	●
			SMB	○	●
			SNMP	-	●
		System Log	○	○	
	Webpage		○	●	
	Security	Password	-	●	
Access Control		-	●		
IPP Authentication		-	●		

^{*1} You can make the IEEE 802.11b, IEEE 1394, or parallel interface settings. You can also check the Ethernet status.

 **Reference**

For more information about displaying status and changing settings, see p.79 "Using Help on the Web Browser".

Verifying the Network Interface Board Settings

- 1** Start the Web browser.
- 2** In the [Address] box, enter the machine's IP address (for example `http://XXX.XXX,XXX,XXX`, where the Xs are the numbers of the IP address).

The status of the machine you chose appears on the Web browser.

- 3** In the menu area, click the selected menu.

If a sub-menu appears, click it.

Reference

For more information about each item, see p.79 "Using Help on the Web Browser".

Configuring the Network Interface Board Settings

1 Start the Web browser.

2 In the [Address] box, enter the machine's IP address (for example `http://XXX.XXX,XXX,XXX`, where the Xs are the numbers of the IP address).

The status of the machine you chose appears on the Web browser.

3 Click [Administrator Mode].

The dialog box for entering the password and user name appears.

4 Enter your user name and password, and then click [OK].

To use the factory default account, enter no user name and enter "password" for the password.

5 In the menu area, select the item, and then make the necessary settings.

6 Click [Apply].

The configuration is transmitted.

Reference

For more information about making settings, see p.79 "Using Help on the Web Browser".

Using Help on the Web Browser

When using Help for the first time, clicking either **[Help]** in the header area or the icon marked “?” in the work area makes the following screen appear. From there you can check Help in two different ways, as shown below:

❖ Checking a Help Using the Internet

You can check the latest Help updates.

❖ Downloading and Checking Help

You can download Help to your computer’s hard drive and view it. As the Help URL, you can specify the path to the local file to view the Help without connecting to the Internet.

Note

- By clicking **[Help]** in the header area, Help contents normally appear.
- By clicking “?”, the Help icon in the work area, Help for the items shown in the work area normally appears.

Downloading Help

- 1** In the **[OS]** list, select the operating system.
- 2** In the **[Language]** list, select the language.
- 3** Click **[Download]**.
- 4** Download Help by following the messages on screen.
- 5** Save the downloaded compressed file, and then decompress it.

Note

- To check the downloaded Help, specify the path where the file is decompressed.

Linking the address (URL) to the **[Help]** button

You can link the address (URL) of the **[Help]** button to the Help files on the computer or Web server.

- ① Download the Help files on the computer to the desired location.
- ② Using a Web browser, navigate to Top Page and click **[Administrator Mode]**.
- ③ Enter your password, (it is not necessary to enter a user name) and click **[OK]**.
- ④ Click **[Configuration]**, and then click **[Webpage]**.
- ⑤ In the **[Help URL]** box, enter the path to the Help files.
If you copied the Help files to “C:\HELP\EN”, enter “file:///C:/HELP/”. For example, if you copied the files to a Web server and the index URL is “http://a.b.c.d/HELP/EN/index.html”, enter “http://a.b.c.d/HELP/”.
- ⑥ Click **[Apply]**.

Remote Maintenance by telnet

You can view printer status and configure the network interface board using telnet.

Note

- You should specify a password so only the network administrator, or a person with network administrator privileges, can use remote maintenance.
- The password is the same as that used for configuring the network interface board with a Web browser.
- If you change a password using remote maintenance, the other passwords are also changed.

Using telnet

Follow the procedure below to use telnet.

Limitation

- Only one person at a time can be logged on to do remote maintenance.

1 Using the machine's IP address or host name, start telnet.

```
% telnet IP_address
```

Note

- In order to use the host name instead of the IP address, you must write it to the hosts file.

2 Enter the password.

Note

- The default is "password".

3 Enter a command.

Reference

For more information about telnet commands, see p.82 "Commands List".

4 Quit telnet.

```
msh> logout
```

When the configuration changes, a message asks whether the changes should be saved or not.

5 Enter "yes" to save the changes, and then press the [ENTER] key.

If you do not want to save the changes, enter "no", and then press the [ENTER] key. If you want to make additional changes, enter "return", and then press the [ENTER] key.

Note

- If "Cannot write NVRAM information" appears, the changes are not saved. Repeat the steps above, as necessary.
- The network interface board is automatically reset when the changes are saved.
- When the network interface board is reset, active print jobs already sent to the machine will be finished. However, jobs not already sent will be canceled.

Commands List

Use the “help” command to display remote maintenance use.

Note

- Enter “help” to display a list of commands that can be used.

```
msh> help
```

- Enter “help *command_name*” to display information about the syntax of that command.

```
msh> help command_name
```

TCP/IP address

Use the “ifconfig” command to configure the Ethernet interface, the IEEE 1394 interface/IEEE 802.11b, and the TCP/IP (IP address, subnet mask, broadcast address, default gateway address) for the machine.

❖ Reference

```
msh> ifconfig
```

❖ Configuration

```
msh> ifconfig interface_name
parameter address
```

Interface name	Interface to be configured
ether	Ethernet interface ^{*1}
ip1394 ^{*2}	IEEE 1394 interface
wlan ^{*3}	IEEE 802.11b interface

^{*1} If you did not enter an interface name, it will automatically be set to the Ethernet interface.

^{*2} Available when the optional 1394 interface board is installed.

^{*3} You can specify an interface when installing the optional 802.11b interface unit.

Parameter	Meaning
(no parameter)	IP address
netmask	subnet mask
broadcast	broadcast address

❖ Changing the Interface

You can specify either Ethernet interface or IEEE 802.11b interface when using the optional 802.11b interface unit.

```
msh> ifconfig interface up
```

Note

- You cannot specify the optional IEEE 1394 interface board (ip1394).

The following is a sample configuration, using an IP address of 192.168.15.16 on an Ethernet interface:

```
msh> ifconfig ether
192.168.15.16
```

The following is a sample configuration, using a subnet mask of 255.255.255.0 on an Ethernet interface:

```
msh> ifconfig ether netmask
255.255.255.0
```

Note

- This affects the configuration of the network interface board on the IP address used.
- The TCP/IP setting is the same as that of the Ethernet interface and IEEE 802.11b interface.
- To enter an address using hexadecimal, prefix it with “0x”.

Address

❖ Subnet Mask

A number used to numerically “mask” or hide the IP address on the network by eliminating those parts of the address that are alike for all machines on the network.

❖ Broadcast address

A specified address for sending data to specific devices on the network.

Note

- To get the above addresses, contact your network administrator.
- If you do not know the address to configure, use the machine's default.
- The Ethernet interface and IEEE 802.11b interface share the same TCP/IP address. When changing interfaces, the former interface setting is applied to the new interface.
- When installing the optional 1394 interface board, set the subnet so it does not overlap with the Ethernet interface or the IEEE 1394 interface.

Access control

Use the “access” command to view and configure access control. You can also specify two or more access ranges.

❖ Reference

```
msh> access
```

❖ Configuration

```
msh> access ☆ range start-address end-address
```

- ☆ represents a target number between 1 and 5. (Up to five access ranges can be registered and selected.)

Example: To specify accessible IP addresses between 192.168.0.10 and 192.168.0.20:

```
msh> access 1 range
192.168.0.10 192.168.0.20
```

Note

- The access range restricts the workstations from which printing is possible by means of an address. If you do not need to restrict printing, make the setting “0.0.0.0”.
- The entry is invalid if the start address is greater than the end address.
- Up to five access ranges can be specified. The entry is invalid if the target number is omitted.
- Sessions other than those from a Web browser or telnet are limited by access control.

❖ Access control initialization

```
msh> access flush
```

Note

- This restores the factory default so all access ranges become “0.0.0.0”.

DHCP

Use the “dhcp” command to configure the DHCP settings.

❖ Reference

The following command displays the current DHCP settings.

```
msh> dhcp
```

❖ Configuration

You can configure the DHCP settings.

```
msh> dhcp interface_name
[on|off]
```

Note

- Select [on] to enable DHCP. Select [off] to disable DHCP.

❖ Interface Priority Configuration

You can assign priorities governing which interface obtains DHCP parameters.

```
msh> dhcp priority
interface_name
```

Note

- Priority assignment is useful when connecting more than one interface to the machine.
- If an interface is not selected, it appears according to the currently set priority regardless of multiple interface connections.

Interface name	Interface to be configured
ether	Ethernet interface
wlan ^{*1}	IEEE 802.11b interface
ip1394 ^{*2}	IEEE 1394 interface

^{*1} Available when the optional 802.11b interface unit is installed.

^{*2} Available when the optional 1394 interface board is installed.

Reference

For more information about DHCP, see p.97 “Using DHCP”.

Protocol

Use the “set” command to allow or prevent remote access for each protocol.

```
msh> set protocol {up | down}
```

Protocol	
tcpip	“up” means active and “down” means inactive.
appletalk	
netware	
smb	
scsiprint ^{*1}	
ip1394 ^{*1}	
lpr	
ftp	
rsh	
diprint	
web	
snmp	
ipp	
http	

^{*1} Available when the 1394 interface board is installed.

Note

- If you prohibit remote access via TCP/IP and then log out, you cannot use remote access. If you did this by mistake, you can use the control panel to allow access by TCP/IP.
- When you prevent access via TCP/IP, you are also prevented from using ip1394, lpr, ftp, rsh, diprint, web, snmp, ipp, and http.

❖ Display

The following command displays current tcpip, appletalk, netware, and smb settings.

```
msh> set protocol
```

Printer status

The following command can be used to get information about the current printer status:

msh> command

Command	Information that is displayed
status	Status of printer. Information about print jobs.
info	Information about the paper tray, output tray, printer language of printer.
prnlog [ID]	Lists the last 20 print jobs.

Note

- For more information about print jobs is displayed when the ID number is added after the prnlog command.

Reference

For more information about the meaning of the data returned using these commands, see p.103 “Understanding Displayed Information”.

Network interface board configuration settings information

Use the “show” command to display the network interface board configuration settings.

msh> show [-p]

Note

- Add “-p” (as above) to have the information displayed one screen at a time.

Reference

For more information about the meaning of the data returned using this command, see p.108 “Configuring the Network Interface Board”.

System log information

Use the “syslog” command to display information stored in the system log.

msh> syslog

Reference

For more information about the displayed information, see p.113 “System Log Information”.

SNMP

Use the “snmp” command to display and edit SNMP configuration settings such as the community name.

Limitation

- The 1394 interface board supports TCP/IP only.

Note

- You can configure one of ten SNMP access settings numbered 1-10.
- If you change the community name, you must change your computer settings. See p.99 “SNMP”.
- Default access settings 1 and 2 are as follows:

Number	1	2
Community name	public	admin
IP address	0.0.0.0	0.0.0.0
Access type	read-only trap off	read-write trap off

❖ Display

Shows SNMP information and available protocols.

```
msh> snmp ?
```

The following command displays the settings of registered number specified.

```
msh> snmp [registered_number]
```

Omitting the number displays all access settings.

```
msh> snmp [-p]
```

Note

- Add “-p” (as above) to have the information displayed one screen at a time.

❖ Community name configuration

You can set the community name of the registered number.

```
msh> snmp number name
community_name
```

Note

- The community name can consist of up to 15 characters.

❖ Access type configuration

You can select the access type from those listed below:

```
msh> snmp number type
access_type
```

Access type	Type of access permitted
read	Read only
write	Read and write
trap	User notified of trap messages.
no	All access denied.

❖ Protocol configuration

You should use the following command to set protocols to active or inactive. If you set a protocol to inactive, all access settings for that protocol will be disabled:

```
msh> snmp {ip | ipx} {on | off}
```

- “on” means active, “off” means inactive.

To change an access setting protocol, use the following command. However, if you have disabled a protocol using the above command, making it active here will have no effect.

```
msh> snmp number active
{ip | ipx} {on | off}
```

❖ Access configuration

You can configure a host address according to protocols used.

The network interface board accepts requests only from hosts with “read-only” or “read-write” access type addresses. Enter “0” to have the network interface board accept requests from any host without requiring a specific type of access.

```
msh> snmp number {ip | ipx}
address
```

Note

- To specify TCP/IP protocol, enter “ip” followed by a space, and then the IP address.
- To specify the IPX/SPX protocol, enter “ipx” followed by a space, and then the IPX address followed by a decimal, and then the MAC address of the network interface board.

The following is a sample configuration using the registration number 3 with the IP address 192.168.15.16:

```
msh> snmp 3 ip 192.168.15.16
```

The following is a sample configuration using the registration number 3 with the IPX address 7390A448, and the MAC address 00:00:74:62:5C:65:

```
msh> snmp 3 ipx 7390A448:0000
```

IPP

Use the “ipp” command to configure IPP settings.

❖ Viewing setting

The following command displays the current IPP setting:

```
msh> ipp
```

Example output:

```
timeout=900(sec)
auth=off
```

- The “timeout” setting specifies how many seconds the computer keeps trying to access the network printer to send print jobs if no connection can be made.
- The “auth” setting indicates the user authentication mode.

❖ IPP timeout configuration

Specify how many seconds to wait before canceling a print job if it has been interrupted for some reason. The time can be from 30 to 65535 seconds.

```
msh> ipp timeout {30 - 65535}
```

❖ IPP user authentication configuration

Use IPP user authentication to restrict printing with IPP to certain users. The default is “off”.

```
msh> ipp auth {basic|digest|off}
```

- “basic” and “digest” are user authentication settings.
- “off” removes the user authentication.

Note

- If you select “basic” or “digest”, see next section “Configuring IPP user authentication” for how to configure the user name. Up to ten user names are available.

❖ Configuring IPP user authentication

Use the following command:

```
msh> ipp user
```

The following message appears:

```
Input user number (1 to 10):
Enter the number, user name, and
password.
```

```
IPP user name:user1 IPP
password:*****
```

After configuring, the following message appears:

```
IPP configuration changed.
```

Direct printing port

The direct printing port allows printing directly from a computer, connected to the network, to the printer.

Use the “diprint” command to change direct printing port settings.

❖ View settings

The following command displays the current direct printing port settings:

```
msh> diprint
```

Example output:

```
port 9100
timeout=300(sec)
bidirect off
```

- “Port” specifies the port number of the direct printing port.
- The “bidirect” setting indicates whether the direct printing port is bidirectional or not.

❖ Setting timeout

You can specify the timeout interval in use when receiving data from the network.

```
msh> diprint timeout
[30~65535]
```

Note

- The default is 300 seconds.

❖ Bidirectional configuration for the direct printing port

Use this setting to configure whether the direct printing port is bidirectional or not. The default is “off”.

```
msh> diprint bidirect {on
| off}
```

Note

- If you select “on”, SmartDevice-Monitor for Client or Standard TCP/IP on Windows 2000 might not work correctly.

Netware

Use the “netware” command to configure the NetWare settings such as the print server name or file server name.

```
msh> netware parameter
```

Parameter	Settings
pname	Enter the NetWare print server name using up to 47 characters.
fname	Enter the NetWare file server name using up to 47 characters.
encap [802.3/802.2/snap/ethernet2/auto]	Select the encap type.
rnum	Specify the remote printer number.
timeout	Set the timeout.
mode {pserver ps}	Select the print server mode.
mode {rprinter rp}	Select the remote printer mode.
context	Specify the NDS context name.
sap_interva l	Specify the SAP intervals. Each interval can be set to between 0 and 3600 seconds in one-second increments.
login server	Specify “login with a selected file server” as the login mode.
login tree	Specify “login with a selected NDS tree” as the login mode.
tree NDS tree name	Select the NDS tree to log on to.

SMB

Use the “smb” command to configure or delete the NetBEUI settings such as the computer name or workgroup name.

msh> smb parameter

Parameter	Settings
comp	Your computer name consisting of up to 15 characters
group	Workgroup name consisting of up to 15 characters
comment	Comment consisting of up to 31 characters
notif {on off}	You can enable or disable notification of print job completion.
clear comp	Clears the computer name
clear group	Clears the Workgroup name
clear comment	Clears comment

Note

- You cannot use a computer name starting with “RNP” or “rnp”.

ROUTE

Use the “route” command to control the routing table.

This command allows you to configure and display routing information. You can change the network configuration from remote computers using this command.

Note

- The maximum number of routing tables is 16.

Commands	Topics of setting
route add {host net} destination * ¹ gateway * ¹	Adds a host/network route to “destination”, and a gateway address to “gateway” in the table. Host becomes the default.
route delete {host net} destination * ¹	Deletes a host/network route from the table. Host becomes the default.
route get {destination * ¹ }	Displays only route information corresponding to a specified destination. When the destination is unspecified, all routing information is displayed.
route active {host net} destination * ¹ on/off	You can turn the specified destination on or off. Host becomes the default.
route add default gateway * ¹	You can set the default gateway address.
route flush	Deletes all routing information.

*¹ IP address

SLP

Use the “slp” command to configure SLP settings.

You can search the NetWare server using SLP in the PureIP environment of NetWare5/5.1, 6. Use the “slp” command to configure the value of TTL used by the SLP multi-cast-packet.

Note

- The default value of TTL is “1”. A search is executed only within a local segment. If the router does not support multi-cast, the settings are not available even if the TTL value is increased.
- The acceptable TTL value is 1 - 255.

msh> slp ttl {1 - 255}

SPRINT

Use the “sprint” command to view and configure SCSI print (SBP-2) on IEEE 1394.

🔔 Limitation

- ❑ You can use this function when the optional IEEE 1394 board is installed.

❖ Viewing settings

The following command displays the current IEEE 1394 (SCSI print) settings:

```
msh> sprint
```

❖ Bidirectional configuration for IEEE 1394 (SCSI print)

```
msh> sprint bidi {on | off}
```

Use this setting to select whether IEEE 1394 (SCSI print) is bidirectional or not. The default is “on”.

Setting IEEE 802.11b

Use the “wiconfig” command to configure IEEE 802.11b settings.

🔔 Limitation

- ❑ You can make settings when installing the optional 802.11b interface unit.

❖ View settings

The following command displays the current IEEE 802.11b settings.

```
msh> wiconfig
```

The following command displays the IEEE 802.11b card information.

```
msh> wiconfig cardinfo
```

📝 Note

- ❑ If the IEEE 802.11b interface is not working correctly, the IEEE 802.11b card information is not displayed.

❖ Configuration

msh> wiconfig *parameter*

Parameter	Value to be configured
mode [ap 802.11adhoc adhoc]	You can set infrastructure mode (ap), 802.11 ad hoc mode (802.11adhoc), or ad hoc mode (adhoc). The default is 802.11 ad hoc mode.
ssid <i>ID value</i>	You can set SSID in infrastructure mode. The characters that can be used are ASCII 0x20-0x7e (32 bytes). SSID value is set automatically to the nearest access point if the setting has not been made. If the setting has not been made for ad hoc mode, the same value as for infrastructure mode or an “AS-SID” value is automatically set.
channel frequency <i>channel no.</i>	You can set the channel. You can specify from the following channels: <ul style="list-style-type: none"> • Metric Version : 1-13 • Inch Version : 1-11 Set the same channel for all the machines you are using.

Parameter	Value to be configured
enc [on off]	You can enable or disable the WEP function. To enable the WEP function, select [on]; to disable it, select [off]. To start the WEP function, enter the correct WEP key.
key [<i>key value</i>]	64-bit or 128-bit can be set. Only 10 hexadecimal characters can be set when using 64-bit; or 26 hexadecimal characters when using 128-bit. Also, set 0x as the prefix. To use this function, set the same WEP key for all ports that transmit to each other.
auth [open shared]	You can set the authorized mode when using WEP. The specified value and the authorized mode are as follows: open: Open system authorized (default) shared: Shared key authorized

Parameter	Value to be configured
rate [auto 11m 5.5m 2m 1m]	You can set the IEEE 802.11b transmission speed. The transmission speed you specify here is the speed at which data is sent. You can receive data at any speed. auto: automatically set (default) 11m: 11 Mbps fixed 5.5m: 5.5 Mbps fixed 2m: 2 Mbps fixed 1m: 1 Mbps fixed

Note

- When changing the interface to IEEE 802.11b, see p.82 “TCP/IP address”.
- When configuring the IEEE 802.11b TCP/IP, see p.82 “TCP/IP address”.

Changing the host name

Use the “hostname” command to change the printer name.

```
msh> hostname interface_name
printer_name
```

Interface name	Interface to be configured
ether	Ethernet interface ^{*1}
wlan ^{*2}	IEEE 802.11b interface
ip1394 ^{*3}	IEEE 1394 interface

^{*1} If you did not enter the interface name, it will be automatically set to the Ethernet interface.

^{*2} Available when the optional 802.11b interface unit is installed.

^{*3} Available when the optional 1394 interface board is installed.

Note

- Enter the printer name using up to 15 characters.
- You cannot use a printer name starting with “RNP” or “rnp”.
- The Ethernet interface and IEEE 802.11b interface will have the same printer name.

WINS

Use the “wins” command to configure WINS server settings.

❖ Viewing setting

The following command displays the WINS server IP address:

```
msh> wins
```

Example output:

```
msh> wins
WINS Configuration:
interface_name:
WINS: On
primary server 0.0.0.0
secondary server 0.0.0.0
ScopeID
Current configuration:
primary server 0.0.0.0
secondary server 0.0.0.0
hostname host_name ScopeID
```

Note

- If the IP address obtained from DHCP differs from the WINS IP address, the DHCP address is the valid address.

❖ Configuration

Use the “set” command to make WINS active or inactive.

```
msh> wins interface_name
{on | off}
```

- “on” means active; “off” means inactive.

❖ Setting WINS Server Address

You can make settings for the WINS server address.

```
msh> wins interface_name
{primary | secondary}
IP_address
```

- “primary” is for setting the primary WINS server address.
- “secondary” is for setting the secondary WINS server address.

❖ NBT scope ID setting

You can configure the NBT scope ID.

! Limitation

- Enter a scope ID using up to 31 alphanumeric characters.

```
msh> wins interface_name
scope scope_ID
```

Note

- If you receive different scope IDs from DHCP and WINS, the scope ID from DHCP takes priority.

Interface name	Interface to be configured
ether	Ethernet interface
wlan ^{*1}	IEEE 802.11b interface
ip1394 ^{*2}	IEEE 1394 interface

^{*1} Available when the optional 802.11b interface unit is installed.

^{*2} Available when the optional 1394 interface board is installed.

AutoNet

Use the “autonet” command to configure AutoNet settings.

❖ Display

The following command displays the current AutoNet settings.

```
msh> autonet
```

❖ Configuration

You can configure the AutoNet settings.

```
msh> autonet interface_name
[on|off]
```

Note

- Select **[on]** to enable AutoNet.
- Select **[off]** to disable AutoNet.

❖ Interface Priority Configuration

You can assign priorities governing which interface obtains AutoNet parameters.

```
msh> autonet priority
interface_name
```

Note

- Priority assignment is useful when connecting more than one interface to the machine.
- If an interface is not selected, the interface appears according to the currently set priority, regardless of multiple interface connections.

Interface name	Interface to be configured
ether	Ethernet interface
wlan ^{*1}	IEEE 802.11b interface
ip1394 ^{*2}	IEEE 1394 interface

^{*1} Available when the optional 802.11b interface unit is installed.

^{*2} Available when the optional 1394 interface board is installed.

Reference

For more information about AutoNet, see p.98 “Using AutoNet”.

Changing the password

Use the “passwd” command to change the remote maintenance password.

Important

- Be sure not to forget or lose the password.

Note

- The default password is “password”.

1 Enter “passwd”.

```
msh> passwd
```

2 Enter the current password.

Old password:

3 Enter the new password.

New password:

Note

- The password must consist of three to eight alphanumeric characters and symbols. Passwords are case-sensitive. For example, “R” is different from “r”.
- The password is the same as that used in configuring the network interface board with a Web browser and that used in NIB Setup Tool. If you change a password from telnet, the other passwords are also changed.

4 Enter the new password again.

Retype new password:

DNS

Use the “dns” command to configure or display DNS (Domain Name System) settings.

❖ View setting

The following command displays current DNS settings:

```
msh> dns
```

❖ Using the DNS server obtained from the DHCP server

The following command enables/disables use of the DNS server obtained from the DHCP server:

```
msh> dns dhcp {valid | invalid}
```

- If you use the DNS server obtained from the DHCP server, select “valid”. If not, select “invalid”.

If you set “valid”, the DNS server from the DHCP server is prioritized.

❖ DNS server configuration

The following command enables/disables use of the DNS server address:

```
msh> dns number server server_address
```

The following is a sample configuration using an IP address of 192.168.15.16 on DNS 1 server:

```
msh> dns 1 server 192.168.15.16
```

- You can register up to three DNS server numbers.
- You cannot use “255.255.255.255” as the DNS server address.

Domain name

Use the “domainname” command to display or configure domain name settings.

You can configure the Ethernet interface, IEEE 1394 interface, or IEEE 802.11b interface.

❖ View setting

The following command displays the current domain name:

```
msh> domainname
```

❖ Interface domain configuration

The following command displays or sets the Ethernet interface domain name, IEEE 1394 interface, or IEEE 802.11b interface.

```
msh> domainname interface_name domain_name
```

The following is a sample configuration using a domain name on the Ethernet interface:

```
msh> domainname ether domain_name
```

Interface	Interface that can be set
ether	Ethernet interface
ip1394 *1	IEEE 1394 interface
wlan *2	IEEE 802.11b interface

*1 Available when the optional 1394 interface board is installed.

*2 Available when the optional 802.11b interface unit is installed.

Note

- ❑ A domain name can consist of up to 63 alphanumeric characters.

Setting Protocols

The protocols described in this section provide various functions that can be used on the machine.

Important

- If a protocol is disabled or inactive, functions provided by that protocol cannot be used.

Reference

For more information about setting protocols, consult your network administrator.

❖ TCP/IP

- Functions using ftp, lpr, rsh/rcp, diprint, http, ipp, web, wins, ip1394, snmp ^{*1}, or smb ^{*2}

^{*1} SNMP session using TCP/IP

^{*2} SMB session using TCP/IP

Note

- You cannot switch between protocols, but turning off or disabling TCP/IP will also disable smtp and dns.

❖ AppleTalk

- Printer function using AppleTalk under Macintosh

Note

- This can be configured when a module supporting PostScript 3 is installed in the machine.

❖ NetWare

- Printer function using NetWare server

Note

- In a PureIP environment, you can use only the print server even if this protocol has been turned off or disabled.
- Turning off or disabling NetWare will also disable the SNMP session using IPX/SPX.

❖ SMB

- Printer function using SmartDeviceMonitor for Client
- Printer function using Microsoft Windows Network

❖ SCSI print

- Printer function using the IEEE 1394 interface (SCSI print)

❖ IP1394

- Printer function using the IEEE 1394 interface (IP over 1394)

❖ LPR

- Printer function using standard TCP/IP
- Printer function using the command line

❖ FTP

- Printer function using the command line
- Scanner function using the delivery server
- Function to obtain device information using the command line

❖ RSH/RCP

- Printer function using the command line
- Scanner function using the Network TWAIN Driver
- Function to obtain device information using the command line

❖ DIPRINT

- Printer function using SmartDeviceMonitor for Client

❖ WEB

- Web browser function

❖ SNMP

- Bidirectional communication function using a printer driver
- Function to obtain device information using SmartDeviceMonitor for Client/Admin

❖ IPP

- Printer function using SmartDeviceMonitor for Client

❖ HTTP

- Web browser function
- Printer function using SmartDeviceMonitor for Client
- Function to obtain device information using SmartDeviceMonitor for Client/Admin

 Note

- Disabling http will also disable ipp and web.



Using DHCP

You can use the printer in a DHCP environment. You can also register the printer NetBIOS name on a WINS server when it is running.

If you connect an Ethernet interface and IEEE 1394 (IP over 1394) interface simultaneously, pay attention to the following:

❖ When a static IP address is set for both interfaces

- IP Address: If interface IP addresses overlap, the Ethernet interface is selected.
- Subnet Mask: If interface subnet masks overlap, the Ethernet interface is selected.
- Gateway Address: The selected value is applied.

Note

- Make the gateway address setting inside the subnet set in the interface.
- If a value is beyond the range of the subnet selected by the interface, the machine operates using "0.0.0.0".

❖ When obtaining addresses from the DHCP server

- IP Address, Subnet Mask: you can configure addresses assigned by a DHCP server.

Note

- If IP addresses overlap or the same subnet IP addresses are selected, the effective value is assigned only to the prioritized interface.
- Ethernet has default interface priority.

- AutoNet: A temporary IP address starting with 169.254 and not used on the network, is assigned to the prioritized interface.

Note

- Default interface priority is IEEE 1394 (IP over 1394).
- Gateway Address, DNS Server Address, and Domain Name: You can configure the addresses assigned by DHCP to the prioritized interface.
If the gateway address is beyond the range of the subnet selected for the interface, the machine operates using "0.0.0.0".

Note

- Ethernet has default interface priority.

❖ When there are static IP addresses and addresses assigned by DHCP

- IP Address and subnet mask: if a static IP address is the same as an address assigned by DHCP, or the static subnet mask address and the subnet mask address assigned by DHCP overlap, the machine uses the static IP address interface.

Note

- The interface with the DHCP setting is set by default.
 - Gateway Address: operates using the address entered manually.

Note

- ❑ If a static address is not selected, or is set to 0.0.0.0, the interface using the address assigned by DHCP is used.

Note

- ❑ Printers that register the printer NetBIOS name on a WINS server must be configured for the WINS server. See p.92 “WINS”.
- ❑ Supported DHCP servers: Microsoft DHCP server - included with Windows 2000 Server, Windows Server 2003, and Windows NT 4.0; and the DHCP servers included with NetWare and UNIX.
- ❑ If you do not use the WINS server, reserve the printer's IP address in the DHCP server so the same IP address is assigned every time.
- ❑ To use the WINS server, change the WINS server setting to “active” using the control panel.
- ❑ Using the WINS server, you can configure the host name via the remote network printer port.
- ❑ DHCP relay-agent is not supported. If you use DHCP relay-agent on a network via ISDN, it will result in increased line charges. This is because your computer connects to the ISDN line whenever a packet is transferred from the printer.
- ❑ If there is more than one DHCP server, use the same setting for all servers. The machine operates using data from the DHCP server that responds first.

Using AutoNet

If the printer IP address is not automatically assigned by the DHCP server, a temporary IP address starting with 169.254 and not used on the network can be automatically selected by the printer.

Note

- ❑ The IP address assigned by the DHCP server is given priority over that selected by AutoNet.
- ❑ You can confirm the current IP address on the configuration page. For more information about the configuration page, see *Printer Reference 2*.
- ❑ When AutoNet is running, the NetBIOS name is not registered on the WINS server.
- ❑ The machine cannot communicate with devices that do not have the AutoNet function.

SNMP

The machine is equipped with an SNMP (Simple Network Management Protocol) agent that operates under UDP and IPX on the Ethernet/wireless LAN interface, and UDP on the IEEE 1394 (IP over 1394) interface. Using the SNMP manager you can get information about the machine.

The default community names are “public” and “admin”. You can get MIB information using these community names.

Important

- If you change the machine’s community name to one different from the default, use SNMP Setup Tool to change the setting for the computer. For more information, see SNMP Setup Tool Help.

Note

- Before using SNMP Setup Tool, install SmartDeviceMonitor for Admin.
- Follow the procedure below to start SNMP Setup Tool:
 - Windows 95/98/Me, Windows 2000, Windows NT 4.0:
On the **[Start]** menu, point to **[Programs]**, point to **[SmartDeviceMonitor for Admin]**, and then click **[SNMP Setup Tool]**.
 - Windows XP, Windows Server 2003:
On the **[Start]** menu, point to **[All Programs]**, point to **[SmartDeviceMonitor for Admin]**, and then click **[SNMP Setup Tool]**.

❖ Supported MIBs

- MIB-II
- PrinterMIB
- HostResourceMIB
- RicohPrivateMIB

Error Messages on the Display

This section describes the most common network-related messages that appear on the display. If a message not described here appears, act according to that message.

Messages without Code Numbers

Reference

Before turning the main power off, see “Turning On the Power”, *Copy Reference*.

Message	Causes	Solutions
Ethernet Board Error	An error has occurred in the Ethernet board.	Turn off the main power switch, and back on again. If the message appears again, contact your sales or service representative.
Problem:IEEE1394 board	An error has occurred in the IEEE 1394 board.	
Connect failed:IEEE802.11b	IEEE 802.11b card was not inserted when the machine was turned on, or it was pulled out after the machine turned on. An error has occurred in the IEEE 802.11b card.	Turn off the main power switch, and check the card is installed correctly. If the message appears again, contact your sales or service representative.
Problem:IEEE802.11b card	An error has occurred in the IEEE 802.11b card.	Turn off the main power switch, and back on again. If the message appears again, contact your sales or service representative.
Problem:IEEE802.11b board	An error has occurred in the IEEE 802.11b unit.	

Messages with Code Numbers

Note

A message reporting an error appears on the display as shown.

Message	Causes	Solutions	Code numbers
Cannot connect with DHCP server	The DHCP server cannot be found.	Check the DHCP server is running on the network.	101
			201
			301
The same IP Address already exists	The specified IP address overlaps another IP address.	The IP address specified for the machine overlaps another IP address in use. Check the address of the device indicated in <MAC address>.	102
			202
			302
Check network settings	An unauthorized value is specified as the IP address or gateway address.	Change the IP address, subnet mask, or gateway address to the correct value.	103
			203
			303
The same IP Address exists on several interfaces	IP addresses overlap across multiple interfaces. IP addresses of simultaneously operating interfaces overlap.	The IP address of the specified interface overlaps the IP address of another interface. Configure the IP address so it does not overlap.	004
Cannot set within the same subnet range	Subnet masks overlap across multiple interfaces. The subnet masks of simultaneously operating interfaces overlap.	The subnet range of the specified interface overlaps the subnet range of another interface. Configure the subnet mask so it does not overlap.	005
Cannot connect with NetWare server	Cannot contact to the specified file server.	The file server is refusing the connection for some reason. Check the file server setting. See p.51 "Printing with NetWare".	106
			206
Cannot connect with NetWare print server	Cannot contact to the specified file server in remote printer mode.	The print server is refusing the connection for some reason. Check the print server setting. See p.51 "Printing with NetWare".	107
			207
This NetBIOS name is already in use	The NetBIOS name overlaps.	The interface's NetBIOS name specified overlaps another interface's NetBIOS name. Configure the NetBIOS name so that it does not overlap.	108
			208
			308

❖ **Code Numbers**

The problem interface is displayed.

- 1XX: Ethernet
- 2XX: IEEE 802.11b
- 3XX: IEEE 1394
- 0XX: Independent of interface

❖ **Order of priority of messages (when multiple errors occur)**

Order of interface priority

- 1.Ethernet
- 2.IEEE 802.11b
- 3.IEEE 1394

Order of protocol priority

- 1.TCP/IP
- 2.NetWare
- 3.NetBEUI
- 4.AppleTalk

 **Note**

- When messages for the same protocol appear, they are displayed ascending in code order.

Understanding Displayed Information

This section describes how to read the status information returned by the network interface board.

Print Job Information

Print job status can be viewed using the following commands:

- telnet : Use the “status” command. See p.85 “Printer status”.

Item name	Meaning
Rank	Print job status: <ul style="list-style-type: none"> • Active Printing or preparing for printing • Waiting Waiting to be transferred to the printer
Owner	Print request user name
Job	Print request number
Files	The name of the document
Total Size	The size of the data (spooled) The default is “0 bytes”.

Print Log Information

This is a record of the most recent 20 jobs printed.

This log can be displayed with the following commands:

- telnet : Use the “prnlog” command. See p.85 “Printer status”.

Name	Meaning
ID	Print request ID
User	Print request user name
Page	The number of pages printed
Result	The result of the print request
Time	The time the print request was received
UserID * ¹	User ID is to be configured using the printer driver
JobName * ¹	The name of the document for printing

*¹ Displays UserID and JobName information when entering the “prnlog” command using the ID.

Machine Status and Configuration

You can check the machine status and configuration using telnet or UNIX.

❖ telnet

Use the “info” or “status” command.

❖ UNIX

Use the “lpr” or “lpstat” command, or “stat”, “info” parameter of rsh, rcp, or ftp.

Machine status

Status	Description
Call Service Center	Call service center and ask for assistance.
Cover Open: Front Cover	The machine's front cover is open.
Cover Open: Lower Right Cover	The machine's lower-right cover is open.
Cover Open: Right Cover	The machine's center-right cover is open.
Cover Open: Internal Tray2 Exit	The machine's internal tray exit is open.
Empty: Toner	Toner has run out.
Energy Saver Mode	The machine is standing by in Energy Saver mode.
Error: Ethernet Board	An Ethernet board error has occurred.
Error: IEEE1394 Board	An IEEE 1394 board error has occurred.
Error: Memory Switch	Memory switch data is corrupt.
Error: Parallel I/F Board	A parallel interface board error has occurred.
Error: USB Interface	A USB interface board error has occurred.
Error: Wireless Card	Wireless card is not inserted.
Error: Wireless Card or Board	A wireless card or wireless board error has occurred.
Error: Optional Font	An optional font error has occurred.
Error: DIMM Value	A DIMM value error has occurred.
In Use: Input Tray	Paper tray is in use.
Key Card not inserted	The machine is waiting for key card to be inserted.
Key Counter not inserted	The machine is waiting for key counter to be inserted.
Low: Toner	Toner has almost run out.
Malfunction: Ext. Charge Unit	There is a problem with the external charge unit.

Status	Description
Malfunction: Tray 2	There is a problem with tray 2.
Malfunction: Tray 3	There is a problem with tray 3.
Malfunction: Tray 4	There is a problem with tray 4.
Mismatch: Paper Size	Indicated paper tray does not contain paper of selected size.
Mismatch: Paper Size and Type	Indicated paper tray does not contain paper of selected size and type.
	Auto Paper Select cannot detect selected paper size and type.
Mismatch: Paper Type	Indicated paper tray does not contain paper of selected type.
No Paper: Selected Tray	Selected tray has run out of paper.
Not Detected: Selected Tray	Selected tray is not attached or is not attached correctly.
Paper Misfeed: Duplex Unit	Paper has jammed in duplex unit.
Paper Misfeed: Input Tray	Paper has jammed in paper feed path.
Paper Misfeed: Internal Path	Paper has jammed in the machine.
Paper Misfeed: Internal Tray 2	Paper has jammed in internal tray 2.
Printing	Printing is in progress.
Ready	The machine is ready to print.
Tray Error: Duplex Printing	Selected paper tray cannot be used for duplex printing.
Warming Up/Adjusting...	The machine is warming up or waiting to finish replenishing toner.

Machine configuration

Note











- "*" (asterisk) is displayed with the current setting.
- Regarding *1-*5, see table below.

Item	Description
Input Tray	
No.	ID number of the paper tray
Name	Name of the paper tray* ¹
Paper Size	Paper size loaded in the paper tray* ²
Status	Current status of the paper tray* ³
Output Tray	
No.	ID number of the output tray
Name	Name of the output tray* ⁴
Status	Current status of the output tray* ⁵

❖ *1 Input Tray: Name

Name	Description
Tray X	Name of installed paper tray (X is the number of tray.)
Bypass Tray	Bypass tray

❖ *2 Input Tray: Paper Size

Paper size	Description
A3 (297 × 420)	A3 
B4JIS (Japanese Industrial Standard) (257 × 364)	B4 
A4 (297 × 210)	A4 
A4 (210 × 297)	A4 
B5JIS (257 × 182)	B5 
B5JIS (182 × 257)	B5 
A5 (210 × 148)	A5 
A5 (148 × 210)	A5 
A6 (105 × 148)	A6 
11 × 17	DLT 
8 ¹ / ₂ × 14	LG 

Paper size	Description
8 ¹ / ₂ × 11	LT
11 × 8 ¹ / ₂	LT
5 ¹ / ₂ × 8 ¹ / ₂	HLT
8 ¹ / ₂ × 5 ¹ / ₂	HLT
Custom Size	Custom Size
10 ¹ / ₂ × 7 ¹ / ₄	Executive
7 ¹ / ₄ × 10 ¹ / ₂	Executive
8 ¹ / ₄ × 13	Folio
8 ¹ / ₂ × 13	Foolscap
8 × 13	8"×13"
8K (267 × 390)	8K
16K (195 × 267)	16K
16K (267 × 195)	16K

❖ *3 Input Tray: Status

Status	Description
Normal	----
Not Detected	There is no paper tray.
No Paper	There is no paper in the paper tray.

❖ *4 Output Tray: Name

Name	Description
Internal Tray 1	Internal tray 1
Internal Tray 2	Internal tray 2

❖ *5 Output Tray: Status

Status	Description
Normal	----
Paper In	There is paper in the output tray.
Full	Output tray is full of paper.
Error	Other error

Configuring the Network Interface Board

The network interface board settings can be displayed using the commands below.

- telnet : Use the “show” command. See p.85 “Network interface board configuration settings information”.

Item name	Meaning
Common	
Mode	
Protocol Up/Down	“Up” means active; “Down” means inactive.
AppleTalk	
TCP/IP	
NetWare	
SMB	
IP over 1394 *1	
SCSI print *1	
Ethernet interface	
Syslog priority	
NVRAM version	
Device name	
Comment	
Location	Internal version number
Contact	
Soft switch	Internal version number
AppleTalk	
Mode	AppleTalk protocol selected
Net	Network number
Object	Macintosh printer name
Type	The type of printer
Zone	Name of zone the printer belongs to

Item name	Meaning
NetWare EncapType RPRINTER number Print server name File server name Context name Switch Mode NDS/Bindery Packet negotiation Login Mode Print job timeout Protocol SAP interval time NDS Tree Name	Frame type Remote printer number Print server name Name of the connect file server Context of print server Active mode (this value is fixed) (this value is fixed) Time of the job timeout Protocol names that can be used Intervals under the SAP function NDS Tree Name
SMB Switch Mode Direct print Notification Workgroup name Computer name Comment Share name[1] Protocol	(this value is fixed) (this value is fixed) Notification of print job completion Name of the workgroup Name of the computer Comment Share name (name of the printer type)

Item name	Meaning
IEEE 802.11b ^{*3} Device name DHCP Address Netmask Broadcast SSID Channel range Channel Communication mode Authentication Tx Rate WEP encryption Encryption key	Dynamic Host Configuration Protocol IP address Subnet mask Broadcast address SSID being used Channels available for use Channel being used IEEE 802.11b interface transmission mode Validity or invalidity of the authorized mode setting when using WEP IEEE 802.11b interface speed Enable or disable WEP 64-bit WEP key/128-bit WEP key
IP over 1394 ^{*1} Device name DHCP Address Netmask Broadcast	Name of the machine Dynamic Host Configuration Protocol IP address Subnet mask Broadcast address
SCSI print ^{*1} Bidi.	Bidirectional setting (on/off)
DNS Server[☆] ^{*4} use DHCP parameters	DNS server address
Domain name ether ip1394 ^{*1} wlan ^{*3}	Ethernet interface domain name IEEE 1394 interface domain name IEEE 802.11b interface domain name

Item name	Meaning
WINS	
ether	Ethernet interface WINS name
Primary WINS	Primary WINS server address
Secondary WINS	Secondary WINS server address
ip 1394 * ¹	IEEE 1394 interface WINS name
Primary WINS	Primary WINS server address
Secondary WINS	Secondary WINS server address
wlan * ³	IEEE 802.11b interface WINS name
Primary WINS	Primary WINS server address
Secondary WINS	Secondary WINS server address
Shell mode	Mode of the remote maintenance tool

*¹ You can display these item names when installing the optional 1394 interface board.

*² ☆ represents a target number between 1 and 5.

*³ You can display these item names when installing the optional 802.11b interface unit.

*⁴ ☆ represents a target number between 1 and 3.

Message List

This is a list of messages written to the machine's system log. The system log can be viewed using the "syslog" command.

System Log Information

You can use the following methods to view the system log:

- telnet : Use the "syslog" command. See p.85 "System log information".

Message	Causes and solutions
Access to NetWare server <file server name> denied. Either there is no account for this print server or the NetWare server or the password was incorrect.	(In print server mode) Cannot log on to the file server. Make sure the print server is registered on the file server. If a password is specified for the print server, delete it.
add_sess: bad trap addr:<IpAddress>, community:<community name>	The IP address (0.0.0.0) is unavailable when the community access type is TRAP. Specify the host IP address for the TRAP destination.
add_sess: community<community name> already defined.	The same community name already exists. Use another community name.
add_sess_ipx: bad trap addr: <IPX address>, <community name>	The IPX address (00:00:00:00:00:00) is unavailable when the community access type is TRAP. Specify the host IPX address for the TRAP destination.
add_sess_ipx: community <community name> already defined.	The community name already exists. Use another community name.
ANONYMOUS FTP LOGIN FROM <IP address>, <password>	An anonymous login has been made with a password <password> from the host <IP address>.
anpd start.(AppleTalk)	An anpd (AppleTalk Network Package Daemon) has started.
Attach FileServer= <file server name>	Attached to the file server as a nearest server
Attach to print queue <print queue name>	(In print server mode) Attached to the print queue name
Cannot create service connection	<p>If the remote printer is working: A connection with the file server cannot be established. The amount of data may have exceeded the file server's user limit.</p> <p>If the remote printer is working: The printer with the required <printer number> does not appear in <print server name>. Check the printer number of the printer registered in the print server.</p>

Message	Causes and solutions
Cannot find rprinter (<print server name>/<printer number>)	Check the printer number registered in the print server.
Change IP address from DHCP Server.	The IP address changes when DHCP LEASE is renewed. To always assign the same IP address, set a static IP address to the DHCP server.
child process exec error! (process name)	The network service failed to start. Turn the printer off and then on. If this does not work, contact your service or sales representatives.
Connected DHCP Server (<DHCP server address>).	The IP address was successfully received from the DHCP server.
connection from <IP address>	Logged on from the host <IP address>
Could not attach to PServer <print server name>	When using a remote printer: Cannot connect to the print server. The print server is rejecting the connection for some reason. Check the print server settings.
Could not attach to FileServer <error code>	When using a remote printer: Cannot connect to the file server. The file server is rejecting the connection for some reason. Check the file server settings.
Current Interface Speed:xxxMbps	The speed of the network (10 Mbps or 100 Mbps)
Current IP address <current IP address>	The IP address <current IP address> was received from the DHCP server.
Current IPX address <IPX address>	The current IPX address
DHCP lease time expired.	DHCP lease time has expired. The printer tries to locate the DHCP server again. The IP address used till now becomes invalid.
DHCP server not found.	The DHCP server cannot be found. Make sure the DHCP server is running on the network.
dhcpcd start.	A dhcpcd (DHCP client server) has started.
Duplicate IP=<IP address>(from <MAC address>).	The same IP address is used. Every IP address must be unique. Check the address of the device indicated in <MAC address>.
Established SPX Connection with PServer, (RPSocket=<socket number>, connID =<connection ID>)	(In remote printer mode) A connection with the print server has been established.
exiting	lpd service has ended and the system is closing down.
Exit pserver	(In print server mode) Exits the print server because necessary print server settings have not been made.

Message	Causes and solutions
Frametype =<frame type name>	The <frame type name> is configured to be used on NetWare.
httpd start.	httpd has started.
IEEE 802.11b <Transmission mode> mode	<p>Transmission mode for IEEE 802.11b (Example: current mode is infrastructure mode.)</p> <p>IEEE 802.11b [infrastructure] mode (Example: current mode is 802.11 ad hoc mode.)</p> <p>IEEE 802.11b [802.11 ad hoc] mode (Example: current mode is ad hoc mode.)</p> <p>IEEE 802.11b [ad hoc] mode</p>
IEEE 802.11b current channel <Channel>	<p>The current channel is displayed.</p> <p>The value selected by the user is displayed in ad hoc mode.</p> <p>The channel used in the access point is displayed in infrastructure mode. (Example: current channel is 11.)</p> <p>IEEE 802.11b current channel 11</p>
IEEE 802.11b Card Firmware REV. <Version>	<p>IEEE 802.11b interface unit Firmware version (Example: current version is 0.8.3.)</p> <p>IEEE 802.11b interface unit Firmware REV. 0.8.3</p>
IEEE 802.11b MAC Address = <MAC Address>	<p>The IEEE 802.11b I/F MAC address is displayed. (Example: current MAC address is 00:00:74:XX:XX:XX.)</p> <p>IEEE 802.11b MAC Address = 00:00:74:XX:XX:XX</p>
IEEE 802.11b SSID <ssid> (AP MAC Address < MAC Address>)	<p>The access point SSID used in infrastructure mode and the MAC address of the access point are displayed. (Example: current MAC address is xx:xx:xx:xx:xx:xx and SSID value is "test-ssid".)</p> <p>IEEE 802.11b SSID test-ssid (AP MAC Address xx:xx:xx:xx:xx:xx)</p>

Message	Causes and solutions
IEEE 802.11b TX Rate <Transfer Speed>	The IEEE 802.11b transmitting speed (set speed) is displayed. (Example: current Tx Rate is 11 Mbps.) IEEE 802.11b Tx Rate 11 Mbps Transmission speeds vary depending on signal quality. Displayed values may differ from actual transmission speed.
inetd start.	An inetd has started.
<interface> started with IP: <IP address>	<IP address> has been set for <Interface> and <Interface> started.
<Interface>: Subnet overlap.	Subnet from Netmask and the IP address you tried to set for <Interface> overlap the subnet of another interface. Set Subnet so it does not overlap with another interface.
IPP cancel-job: permission denied.	The printer could not authenticate the name of the user attempting to cancel a job.
ipp disable.	Printing with ipp is disabled.
ipp enable.	Printing with ipp is enabled.
IPP job canceled. jobid=%d.	The spooled job has been canceled due to error or user request.
job canceled. jobid=%d.	The spooled job has been canceled due to error or user request.
LeaseTime=<lease time>(sec), RenewTime=<renew time>(sec).	The resource lease time received from the DHCP server is <lease time> in seconds. The renewal time is also <renew time> in seconds.
Login to fileserver <file server name> (<IPX IP>,<NDS BINDERY>)	(In print server mode) Logged on to the file server with NDS or BINDERY mode.
multid start.	Data transmission service for multiprotocols has started.
Name registration failed. name=<NetBIOS name>	The printer could not register the name of NetBIOS.
Name registration success in Broadcast name=<NetBIOS name>	The NetBIOS name was successfully registered from a broadcast.
Name registration success. WINS Server=<WINS Server Address> NetBIOS Name=<NetBIOS name>	The NetBIOS name was successfully registered to the WINS server.
nbstart start.(NetBEUI)	The server for setting the NetBEUI protocol stack has started.
nbttd start.	nbttd (NetBIOS over TCP/IP Daemon) has started. (Available only in DHCP mode)

Message	Causes and solutions
NetBEUI Computer Name =<computer name>	The NetBEUI Computer Name is defined as <computer name>.
nmsd start. (NetBEUI)	nmsd (Name Server Daemon) has started.
nprinter start. (NetWare)	(In remote printer mode) NetWare service has started.
nwstart start. (NetWare)	The service for NetWare protocol stack setting has started.
Open log file <file name>	(In print server mode) The specified log file has been opened.
papd start. (Apple Talk)	Apple Talk print service has started.
permission denied.	Job cancellation was determined to be unauthorized after checking the user name and host address (except for ROOT authorization).
phy release file open failed.	A replacement network interface board is required. Contact your sales or service representatives.
Print queue <print queue name> cannot be serviced by printer 0, <print server name>	(In print server mode) The print queue name cannot be serviced. Make sure that print queue volume is on the specified file server.
Print server <print server name> has no printer.	(In print server mode) The printer is not assigned to the print server <print server name>. Using NWadmin, assign the printer, and then restart the printer device.
Print sessions full	Cannot accept the print session.
Printer <printer name> has no queue.	(In print server mode) The print queue is not assigned to the printer. Using NWadmin, assign the print queue to the printer, and then restart it.
pserver start. (NetWare)	(In print server mode) NetWare service has started.
Required computer name (<Computer name>) is duplicated name.	The same computer name is detected on the network. The start job determines the computer name by adding it to the suffix (0,1,...). Configure a new computer name that is unique.
Required file server (<file server name>) not found.	Cannot find the required file server.
restarted.	LPD has started.
sap enable, saptype=<SAP type>, sapname=<SAP name>	The SAP function has started. The SAP (SAP type and SAP name) packet is issued to advertise the service on the NetWare server SAP table.

Message	Causes and solutions
session<community name> not defined.	The requested community name is not defined.
session_ipx<community name> not defined.	The requested community name is not defined.
Set context to <NDS context name>	A <NDS context name> has been set.
shutdown signal received. network service rebooting...	Rebooting the network service.
smbd start. (NetBEUI)	An smbd (SMB (Server Message Block) service) has started.
Snmp over ip is ready.	Communication over TCP/IP via SNMP is available.
Snmp over IP over 1394 is ready.	Communication over IP over 1394 via SNMP is available.
Snmp over ipx is ready.	Communication over IPX via SNMP is available.
snmpd start.	SNMP service has started.
started.	Direct print service has started.
The print server received error <error number> during attempt to log in to the network. Access to the network was denied. Verify that the print server name and password are correct.	Cannot log on to the file server. The print server is not registered or a password is specified. Register the print server without specifying a password.
SMTPC: failed to get smtp server ip-address.	Failed to get the SMTP server IP address. This could be because: <ul style="list-style-type: none"> • The DNS server could not be found. • There is no connection to the network. • The specified DNS server could not be connected to. • Incorrect DNS server is specified. • No specified SMTP server IP address in the DNS server.
SMTPC: failed to connect smtp server. timeout.	Failed to connect the SMTP server due to timeout. This could be because: <ul style="list-style-type: none"> • The SMTP server name is incorrect. • There is no connection to the network. • The network configuration is incorrect, so there is no response from the SMTP server.
SMTPC: refused connect by smtp server.	The connection to the SMTP server is denied. This could be because: <ul style="list-style-type: none"> • Another server other than the SMTP server has been specified. • The SMTP server port number is incorrect.

Message	Causes and solutions
SMTPC: no smtp server. connection close.	<p>No response from the SMTP protocol. Cannot connect to the SMTP server. This could be because:</p> <ul style="list-style-type: none"> • Another server other than the SMTP server has been specified. • The SMTP server port number is incorrect.
SMTPC: failed to connect smtp server.	<p>Failed to connect the SMTP server. This could be because:</p> <ul style="list-style-type: none"> • There is no connection to the network. • The network configuration is incorrect, so there is no response from the SMTP server. • The SMTP server name is incorrect. • The specified SMTP server is incorrect. • There is no specified SMTP server IP address in the DNS server. • Another server other than the SMTP server has been specified. • The SMTP server port number is incorrect.
SMTPC: username or password wasn't correct.	<p>Failed to connect the SMTP server. This could be because:</p> <ul style="list-style-type: none"> • The specified SMTP user name is incorrect. • The specified SMTP password is incorrect. <p>Check the SMTP user name and password.</p>
WINS name registration: No response to server (WINS server address)	<p>There is no response from the server during data registration.</p> <p>Check the WINS server address is correct and WINS server is working properly.</p>
WINS name registration/refresh error code (error code)	<p>The NetBEUI name could not be registered or updated. Make sure the name is not already being used. If the name is not the problem, check that the WINS server address is correct and that the WINS server is working properly.</p>
WINS wrong scopeID	<p>The scope ID is wrong.</p> <p>Specify the correct scope ID.</p>
write error occurred. (diskfull)	<p>The hard disk became full while the spool file was being written.</p> <p>Wait until enough HDD space becomes available as printing proceeds.</p>
write error occurred. (fatal)	<p>A fatal error occurred while the spool file was being written.</p> <p>Turn the printer off and then on. If this does not work, contact your service or sales representative.</p>

When Using Windows Terminal Service/MetaFrame

Operating Environment

The following combinations of operating system and MetaFrame are supported:

- ❖ **Windows NT Server 4.0 Terminal Server Edition**
 - MetaFrame 1.8 SP3/FR1 SP3
 - MetaFrame XP 1.0 SP1/SP2/FR1
- ❖ **Windows 2000 Server /Advanced Server**
 - MetaFrame 1.8 SP3/FR1 SP3
 - MetaFrame XP 1.0 SP1/SP2/FR1/FR2

Supported Printer Drivers

- ❖ **When Windows Terminal Service is operating**
 - PCL5e
 - PCL6
 - PostScript 3

Note

- The RPCS printer driver is not supported.
- Some RPCS printer driver functions do not work if Windows Terminal Service is installed, even if it is not operating.

Limitation

The following restrictions apply in the Windows Terminal Service environment.

These restrictions are due to the way Windows Terminal Service or MetaFrame works.

- ❖ **When printing (Windows Terminal Service)**

When printing a file containing a large number of bitmap images or fonts, some images or font settings may be lost. We strongly recommend testing this function under your network environment before applying it to actual jobs.
- ❖ **When using [Auto-creating client printers] (MetaFrame)**

[Auto-creating client printers] can select a logical printer created by copying the client's local printer data to the MetaFrame server. We strongly recommend testing this function under your network environment before applying it to actual jobs.

 - The settings for optional equipment, such as the finisher or Large Capacity Tray, will not be stored in the server after the equipment is disconnected. The settings for optional items will return to default values each time the client computer logs on to the server.

- When printing a large number of bitmap images or using the server in a WAN environment over dial-up lines such as ISDN, depending on the data rate, printing may be disabled or errors may occur.
 - When using MetaFrame XP 1.0 or later versions, we recommend configuring **[Client Printer bandwidth]** available from **[Citrix Management Console]**, according to the environment.
 - If a printing error occurs on the server and the print job or **[Auto-creating client printers]** cannot be deleted, we recommend doing the following:
 - MetaFrame 1.8 SP3, MetaFrame XP 1.0 SP1/FR1
Configure the **[Delete unfinished print jobs]** settings in the registry. For more information, see the Readme file provided with MetaFrame.
 - MetaFrame XP 1.0 FR2
Configure the **[Delete pending print jobs at logout]** settings in **[Printer Properties Management]** of the Citrix Management Console.
- ❖ **When using [Printer driver replication] (MetaFrame)**
[Printer driver replication] is designed to distribute printer drivers across all servers in a server farm. We strongly recommend testing this function under your network environment before applying it to actual jobs.
- If the printer drivers are not properly copied, we recommend installing them directly onto each server.

Precautions

Please pay attention to the following when using the network interface board. When configuration is necessary, follow the appropriate procedures below.

Connecting a Dial-Up Router to a Network

When using NetWare (file server)

If the NetWare file server and printer are on opposite sides of a router, packets are sent back and forth continuously, possibly incurring communications charges. Because packet transmission is a feature of NetWare, you need to change the configuration of the router. If the network you are using does not allow you to configure the router, configure the machine instead.

❖ Configuring the router

Filter packets so they do not pass over the dial-up router.

Note

- The MAC address of the filtering printer is printed on the printer configuration page. For more information about printing a configuration page, see *Printer Reference 2*.
- For more information about configuring the printer if the router cannot be configured, see the following instructions.

Configuring the printer with NetWare

- 1** Following the setup method described earlier in this manual, configure the file server.
- 2** Set the frame type for NetWare environment.

Reference

For more information about selecting a frame type, see p.13 “Setting Up the Machine on a Network”.

Configuring the printer without NetWare

- 1** When not printing, the network interface board sends packets over the network. Set NetWare to “inactive”.

Reference

For more information about selecting a protocol, see p.13 “Setting Up the Machine on a Network”.

When Using Network Utility

If the machine is connected to a network, observe the following points when setting up the machine or changing settings:

For more details, see the operating instructions and Help for the ScanRouter delivery software and DeskTopBinder.

❖ When a dial-up router is connected in a network environment

The settings for the delivery server to be connected must be made appropriately for the machine with the ScanRouter delivery software, Auto Document Link, or DeskTopBinder. In addition, set up connected devices using the I/O settings of the ScanRouter delivery software Administration Utility.

If the network environment changes, make the necessary changes for the delivery server using the machine, the administration utility of client computers, Auto Document Link, and DeskTopBinder. Also, set the correct information for the connected devices using the I/O settings of the ScanRouter delivery software Administration Utility.

Important

- If the machine is set up to connect to the delivery server via a dial-up router, the router will dial and go online whenever a connection to the delivery server is made. Telephone charges may be incurred.

❖ When connected to a computer that uses dial-up access

- Do not install the ScanRouter delivery software on a computer which uses dial-up access.
- When using the ScanRouter delivery software, DeskTopBinder, Auto Document Link, or a TWAIN driver on a computer with dial-up access, a dial-up connection may be performed when connecting to the delivery server and other equipment, depending on the setup. If the computer is set up to connect to the Internet automatically, the confirmation dialog box will not appear, and telephone charges may be incurred without your being aware of it. To prevent unnecessary connections, the computer should be set up so the confirmation dialog box always appears before establishing a connection. Do not make unnecessary connections when using the above listed software.

NetWare Printing

Form feed

You should not configure form feed on NetWare. Form feed is controlled by the printer driver on Windows. If NetWare form feed is configured, the printer might not work properly. If you want to change form feed settings, always configure them using Windows.

- Under Windows 95/98/Me, clear the **[Form feed]** check box on the **[Printer Settings]** tab in the printer properties dialog box.
- Under Windows 2000/XP, clear the **[Form feed]** check box on the **[NetWare Settings]** tab in the printer properties dialog box.
- Under Windows NT 4.0, clear the **[Form feed]** check box on the **[NetWare Settings]** tab in the printer properties dialog box.

Banner page

You should not configure a banner page on NetWare. If you want to change the banner page setting, always configure it using Windows.

- Under Windows 95/98/Me, clear the **[Enable banner]** check box on the **[Printer Settings]** tab in the printer properties dialog box.
- Under Windows 2000/XP, clear the **[Enable banner]** check box on the **[NetWare Settings]** tab in the printer properties dialog box.
- Under Windows NT 4.0, clear the **[Enable banner]** check box on the **[NetWare Settings]** tab in the printer properties dialog box.

Printing after resetting the machine

After resetting the remote printer, the connection from the print server will be cut off for about 30-40 seconds before re-connecting. Depending on the NetWare specification, print jobs may be accepted, but they will not be printed during this interval.

When using the machine as a remote printer, wait about two minutes after resetting before attempting to print.

When Using IPP with SmartDeviceMonitor for Client

When using IPP with SmartDeviceMonitor for Client, note the following:

- The network printer can only receive one print job from SmartDeviceMonitor for Client at a time. While the network printer is printing, another user cannot access it until the job is finished. In this case, SmartDeviceMonitor for Client tries to access the network printer until the retry interval expires.
- If SmartDeviceMonitor for Client cannot access the network printer and times out, it will stop sending the print job. In this case, you should cancel the paused status from the print queue window. SmartDeviceMonitor for Client will resume access to the network printer. You can delete the print job from the print queue window, but canceling a print job printed by the network printer might cause the next job sent from another user to be incorrectly printed.

- If a print job sent from SmartDeviceMonitor for Client is interrupted and the network printer cancels the job because something went wrong, send the print job again.
- Print jobs sent from another computer do not appear in the print queue window, regardless of protocol.
- If various users send print jobs using SmartDeviceMonitor for Client to network printers, the printing order might not be the same as that in which the jobs were sent.
- An IP address cannot be used for the IPP port name because the IP address is used for the SmartDeviceMonitor for Client port name.

When the IEEE 80211.b interface unit (optional) is installed

When using the wireless LAN interface on the network, note the following:

❖ When moving the machine

Detach the antennas when relocating the machine locally.

After moving the machine, reattach the antennas, ensuring that:

- The antennas are positioned clear of obstacles.
- There is 40 to 60 mm between the antennas, so that they do not touch.
- The exposure glass cover and the Auto Document Feeder (ADF) do not knock the antennas.

❖ If the network area provides poor radio environment

Where radio wave conditions are bad, the network may not function due to interrupted or failed connections. When checking the wireless LAN signal and the access point, follow the procedure below to improve the situation:

- Position the access point nearer to the machine.
- Clear the space between access point and machine of obstructions.
- Move radio wave generating appliances, such as microwaves, away from the machine and access point.

Reference

For information about how to check radio wave status, see p.12 “Checking the machine's radio wave status”.

For more information about access point radio wave conditions, refer to the access point manual.

Specifications

Interface	100BASE-TX, 10BASE-T, IEEE 1394 (IP over 1394) ^{*1} , IEEE 802.11b
Frame type	EthernetII, IEEE 802.2, IEEE 802.3, SNAP
Protocol	<ul style="list-style-type: none"> • Printer (LAN-Fax) <ul style="list-style-type: none"> TCP/IP LPR RSH RCP DIPRINT FTP IPP ^{*2} ^{*3} IPX/SPX (NetWare) AppleTalk ^{*4} NetBEUI SMB ^{*2} ^{*5} • Internet Fax <ul style="list-style-type: none"> TCP/IP SMTP POP IMAP • Network Scanner <ul style="list-style-type: none"> TCP/IP RSH FTP SMTP POP SMB ^{*6} • Management Function <ul style="list-style-type: none"> TCP/IP RSH RCP FTP SNMP HTTP TELNET (mshell) NBT DHCP
SNMP	MIB-II, PrinterMIB, HostResourceMIB, RicohPrivateMIB

^{*1} The 1394 interface board supports only TCP/IP.

^{*2} Use the SmartDeviceMonitor for Client port.

^{*3} To use IPP under Windows XP or Windows Server 2003, use the Standard IPP port. Note, in SmartDeviceMonitor for Client however, this port does not support digest access authentication.

^{*4} This can be used when the PostScript 3 module is installed.

^{*5} Under Windows, this function can be used with TCP/IP and NetBEUI.

^{*6} SMB using NetBEUI is unavailable.

INDEX

A

Access Control, 83
access type, 86
AutoNet, 93, 98

B

Bidirectional SCSI print, 28
Broadcast address, 83

C

Channel, 29
Communication Mode, 29
Communication Speed, 29
community name, 86
configuration
 access type, 86
 community name, 86
 Network Interface Board configuration, 108
 Web Browser, 73

D

Delivery Option, 30
DHCP, 84, 97
dial-up router, 122
Direct Printing Port, 87
DNS, 94
DNS Configuration, 26
Domain Name, 27, 28
Domainname, 94

E

Effective Protocol, 27
Energy saver mode, 72
Ethernet Speed, 27
EtherTalk
 Macintosh, 49

F

File Transfer, 30

G

Gateway Address, 26

H

Host Name, 27, 28, 91

I

IEEE 802.11b, 90
information
 Network Interface Board configuration, 85
 print job, 103
 print log, 103
 system log, 85, 113
Interface Settings/IEEE 1394, 27
Interface Settings/IEEE 802.11b, 29
Interface Settings/Network, 26
IP Address, 26, 27
IP address, 82
IP over 1394, 28
IPP, 87, 124

L

LAN Type, 27

M

Machine configuration, 104, 106
Machine status, 104
Macintosh
 EtherTalk, 49
 printer name, 50
 zone, 50
message, 113
MIB, 99

N

NBT scope ID setting, 92
NW Frame Type, 27

P

password, 93
precautions, 122
printer name
 Macintosh, 50
printer status, 85

R

remote maintenance
 telnet, 81
Return to Defaults, 29
ROUTE, 89

S

SCSI print (SBP-2), 28
SLP, 89
SmartDeviceMonitor for Client, 124
SMB, 89
SMTP Server, 30
SNMP, 85, 99
specifications, 126
SPRINT, 90
SSID Setting, 29
subnet mask, 83
system Log, 113
system log
 information, 85

T

Telnet, 104
telnet
 remote maintenance, 81
 using, 81

U

UNIX, 104

W

Web Browser, 73
WEP (Encryption) Setting, 29
WINS, 92
Wireless LAN Signal, 29

Z

zone
Macintosh, 50

