



Printer/Scanner Unit Type 2018

Operating Instructions Scanner Reference



-
- 1 Network Scanner
 - 2 Preparations for Use as a Network Scanner
 - 3 Setting Originals
 - 4 Sending Scan Files by E-mail
 - 5 Using the Network Delivery Scanner Function
 - 6 Using the Network TWAIN Scanner Function
 - 7 Appendix

Introduction

This manual contains detailed instructions and notes on the operation and use of this machine. For your safety and benefit, read this manual carefully before using the machine. Keep this manual in a handy place for quick reference.

The scanner function is available when the Printer/Scanner option is installed in the machine.

Caution:

Use of controls or adjustments or performance of procedures other than those specified in this manual might result in hazardous radiation exposure.

Two kinds of size notation are employed in this manual. With this machine refer to the metric version.

Manuals for This Machine

The following manuals describe the operational procedures of this machine. For particular functions, see the relevant parts of the manual.

Note

- The manuals provided are specific to machine type.
- Adobe Acrobat Reader is necessary to view the manuals as a PDF file.
- Three CD-ROMs are provided:
 - CD-ROM 1 "Operating Instructions for Printer / Scanner"
 - CD-ROM 2 "Scanner Driver & Document Management Utilities"
 - CD-ROM 3 "Operating Instructions for General Settings and Facsimile"

❖ **General Settings Guide (PDF file - CD-ROM3)**

Provides an overview of the machine and describes System Settings (paper trays, Key Operator Tools, etc.), and troubleshooting.

Refer to this manual for Address Book procedures such as registering fax numbers, e-mail addresses, and user codes.

❖ **Network Guide (PDF file - CD-ROM1)**

Describes procedures for configuring the machine and computers in a network environment.

❖ **Copy Reference**

Describes operations, functions, and troubleshooting for the machine's copier function.

❖ **Facsimile Reference <Basic Features>**

Describes operations, functions, and troubleshooting for the machine's facsimile function.

❖ **Facsimile Reference <Advanced Features>(PDF file - CD-ROM3)**

Describes advanced functions and settings for key operators.

❖ **Printer Reference 1**

Describes system settings and operations for the machine's printer function.

❖ **Printer Reference 2 (PDF file - CD-ROM1)**

Describes operations, functions, and troubleshooting for the machine's printer function.

❖ **Scanner Reference (this manual) (PDF file - CD-ROM1)**

Describes operations, functions, and troubleshooting for the machine's scanner function.

❖ **Manuals for DeskTopBinder Lite**

DeskTopBinder Lite is a utility included on the CD-ROM labeled "Scanner Driver & Document Management Utilities".

- DeskTopBinder Lite Setup Guide (PDF file - CD-ROM2)
Describes the installation of DeskTopBinder Lite, and the operating environment for DeskTopBinder Lite in detail. This guide can be displayed from the **[Setup]** dialog box when DeskTopBinder Lite is installed.
- DeskTopBinder Lite Introduction Guide (PDF file - CD-ROM2)
Describes operations with DeskTopBinder Lite and provides an overview of its functions. This guide is added to the **[Start]** menu when DeskTopBinder Lite is installed.
- Auto Document Link Guide (PDF file - CD-ROM2)
Describes operations and functions of Auto Document Link installed with DeskTopBinder Lite. This guide is added to the **[Start]** menu when DeskTopBinder Lite is installed.

❖ **Manuals for ScanRouter V2 Lite**

ScanRouter V2 Lite is a utility included on the CD-ROM labeled "Scanner Driver & Document Management Utilities".

- ScanRouter V2 Lite Setup Guide (PDF file - CD-ROM2)
Describes the installation of ScanRouter V2 Lite, settings, and the operating environment for ScanRouter V2 Lite in detail. This guide can be displayed from the **[Setup]** dialog box when ScanRouter V2 Lite is installed.
- ScanRouter V2 Lite Management Guide (PDF file - CD-ROM2)
Describes delivery server management and operations, and provides an overview of ScanRouter V2 Lite functions. This guide is added to the **[Start]** menu when ScanRouter V2 Lite is installed.

❖ **Other manuals**

- PostScript3 Supplement (PDF file - CD-ROM1)
- UNIX Supplement (available from an authorized dealer, or as a PDF file on our Web site)

TABLE OF CONTENTS

Manuals for This Machine	i
How to Read This Manual	1
Symbols	1
Names of Major Options	2

1. Network Scanner

Outline	3
E-mail	3
Network Delivery Scanner.....	4
Network TWAIN Scanner	5
Control Panel	6
Reading the Display and Using Keys.....	8

2. Preparations for Use as a Network Scanner

Initial Scanner Setup	9
Scanner Features.....	9
Scan Settings	12
Destination List Settings.....	14
Send Settings.....	14
Installing Software	17
Auto Run Program	17
Software for Using a Network TWAIN Scanner	19
Software for Using the Network Delivery Scanner Function	20
DeskTopBinder Lite.....	21
Software Supplied on CD-ROM	21

3. Setting Originals

Placing Originals	27
Placing on the Exposure Glass	28
Placing in the Auto Document Feeder	29
Original Orientation and Scan Area	31
For E-mail and a Network Delivery Scanner	31
For a Network TWAIN Scanner.....	33
Scanning Originals in Several Times using the Exposure Glass	34

4. Sending Scan Files by E-mail

Preparation for Sending by E-mail	35
E-mail Screen.....	36
Sending Scan Files by E-mail	37
Procedure for Sending by E-mail	37
Checking the Status of E-mail	49

5. Using the Network Delivery Scanner Function

Preparation for Delivering	51
Network Delivery Scanner Screen	52
Delivering Scan Files	54
Delivery Procedure.....	54
Checking the Status of Delivery	64

6. Using the Network TWAIN Scanner Function

Preparation for Using the Network TWAIN Scanner	65
Network TWAIN Scanner Screen.....	65
Scanning Originals	66
Functions of the TWAIN Driver	68

7. Appendix

Relationship between Resolution and File Size	69
When Using as E-mail or Network Delivery Scanner.....	69
When Using as a Network TWAIN Scanner.....	69
Max. Number of Addresses Which Can Be Specified	70
Troubleshooting	71
When Scanning Is Not Performed as Expected.....	71
When the Delivery Function Does Not Work.....	71
When an Error Message Appears on the Control Panel	72
When an Error Message Appears on the Client Computer.....	74
Specifications	77
INDEX	78

How to Read This Manual

Symbols

In this manual, the following symbols are used:

 **Important**

If this instruction is not followed, paper might be misfed, originals might be damaged, or files might be lost. Be sure to read this.

 **Preparation**

This symbol indicates the prior knowledge or preparations required before operating.

 **Note**

This symbol indicates precautions for operation or actions to take after misoperation.

 **Limitation**

This symbol indicates numerical limits, functions that cannot be used together, or conditions in which a particular function cannot be used.

 **Reference**

This symbol indicates a reference.

[]

Keys that appear on the machine's display panel.

[]

Keys and buttons that appear on the computer's display.

[]

Keys built into the machine's control panel.

[]

Keys on the computer's keyboard.

Names of Major Options

Major options of this machine are referred to as follows in this manual:

- Exposure Glass Cover
- Auto Document Feeder → ADF
- Auto Document Feeder capable of scanning both sides of a sheet → ARDF
- Printer/Scanner Unit Type 2018 → printer/scanner controller

The following software products are referred to using a general name:

- DeskTopBinder Lite and DeskTopBinder Professional* → DeskTopBinder
 - ScanRouter V2 Lite, ScanRouter EX Professional* and ScanRouter EX Enterprise* → the ScanRouter delivery software
- *Optional

1. Network Scanner

Outline

By installing the printer/scanner controller, the machine can be used as a network scanner.

As a network scanner, the machine can send scan files by e-mail, operate as a network delivery scanner, and operate as a network TWAIN scanner.

E-mail

Scan files that are attached to an e-mail can be sent using the e-mail system through a LAN or the Internet.

Reference

p.35 "Sending Scan Files by E-mail"

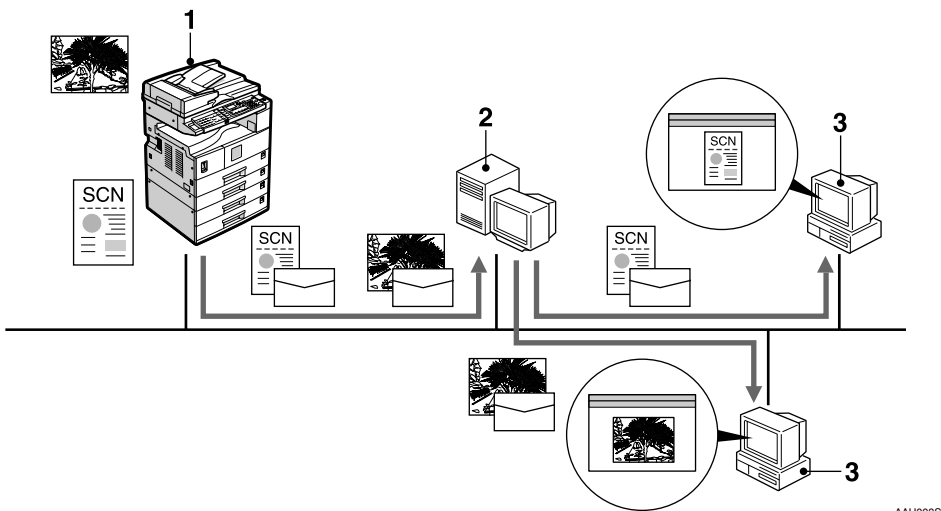

1. This machine

Scan files that are attached to an e-mail can be sent to an e-mail server.

2. E-mail server

An e-mail server is the SMTP server used for an e-mail system. It transfers a received e-mail to a specified destination through a LAN or the Internet.

3. Client computer

An e-mail with scan files attached is received from the e-mail server using e-mail software.

Check the contents of the file with an application appropriate for the file type.

Network Delivery Scanner

The machine is used as a delivery scanner with the ScanRouter delivery software. Scan files are stored in the delivery server and delivered to the folders of client computers on the same network.

Reference

p.51 "Using the Network Delivery Scanner Function"

Note

- When the optional ScanRouter EX Professional is used, the machine can also deliver scan files using e-mail, and the files can be viewed from a client computer using a Web browser.

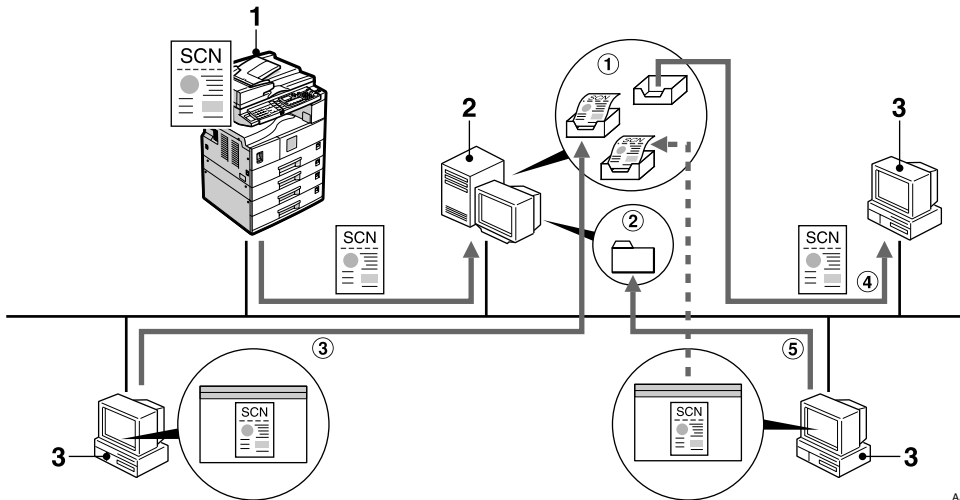

AAH009S

1. This machine

Scan files are sent to the delivery server.

2. Delivery server

The ScanRouter delivery software is installed in this computer which is used as a delivery server.

A received file is delivered to the in-tray of the specified destination. (1 in the figure). According to the settings of the in-tray, the file is stored in the in-tray or in a Windows folder. (2 in the figure)

3. Client computer

The contents of stored files can be checked in the following ways:

- View the file in the in-tray using DesktopBinder Lite to check the contents. (3 in the figure)
- Use Auto Document Link to receive the file stored in the in-tray, and check the contents with an application appropriate for the file type. (4 in the figure)
- Access the Windows folder where the file is stored via the network, and check the contents with an application appropriate for the file type. (5 in the figure)

Reference

For more information about ScanRouter V2 Lite, DeskTopBinder Lite, or Auto Document Link, see p.i “Manuals for This Machine”.

Network TWAIN Scanner

The scanning function of this machine can be used from a client computer via a network (Ethernet, IEEE 1394 (IP over 1394) [optional], or IEEE 802.11b (Wireless LAN) [optional]).

Reference

p.65 “Using the Network TWAIN Scanner Function”

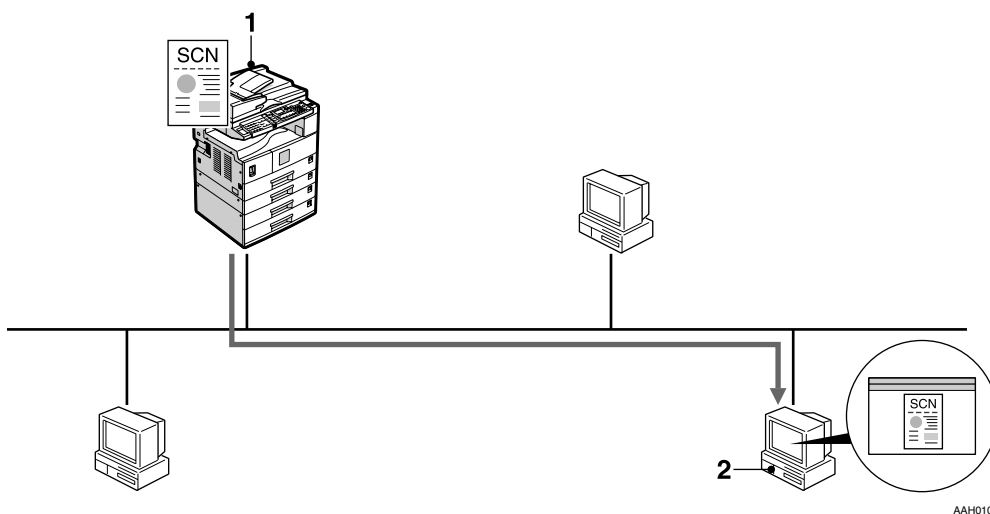

1. This machine

The scanning function of the machine can be used from a client computer via a network.

2. Client computer

Originals are scanned using the TWAIN driver for the machine from an application.

Control Panel

This illustration shows the control panel when options are installed.

1

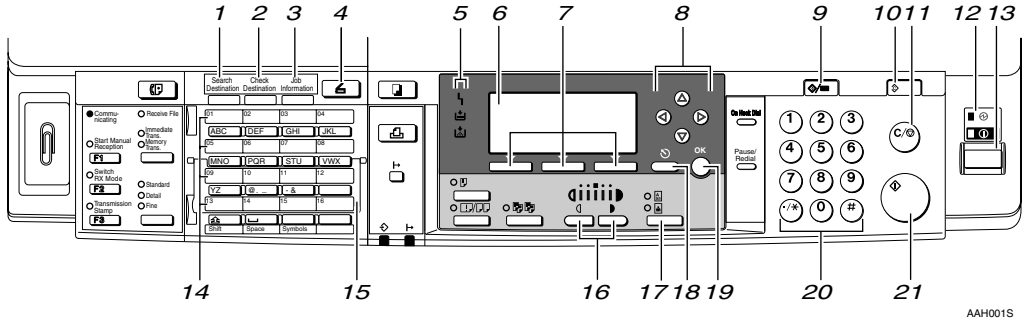

1. [Search Destination] key

Press to search for the destination from the Destination List.

2. [Check Destination] key

Press to check the destinations currently selected.

3. [Job Information] key

Press to check the status of sent and delivered e-mail.

4. [Scanner] key

Press to activate the scanner function.

5. Indicators

Display errors and machine status.

:Error indicator

:Load Paper indicator

:Add Toner indicator

Reference

For more information, see *Copy Reference*.

6. Display

Displays operation status and messages.

7. Selection keys

Correspond to items on the display. Press to select the corresponding item.

8. Scroll keys

Press to select an item.

: scroll upward

: scroll downward

: scroll right

: scroll left

9. [User Tools/Counter] key

Press to change default or operation parameters according to requirement.

10. [Clear Modes] key

Press to clear the current settings.

11. [Clear/Stop] key

Clear: clears an entered numeric value.

Stop: stops scanning.

12. Main power indicator and On indicator

The main power indicator lights when the main power switch is turned on. The On indicator lights when the operation switch is on.

13. Operation switch

Press to turn the power on. The On indicator lights. To turn the power off, press again.

Note

- This key is inactivate during scanning or while setting scanner defaults.

14. Quick Dial keys

Press to select the registered destination with a single touch, or to enter letters and symbols.

Reference

For more information, see *General Settings Guide*.

Note

- You can register up to 32 destinations using the Quick Dial keys.

15. Quick Dial Flip Plate

Flip this plate down to access Quick Dial keys 01 through 16; flip it up to access keys 17 through 32.

16. **[Lighter]** and **[Darker]** keys

Press to change the image density setting. Select the image density in five increments, Lighter to Darker.

17. **[Original Type]** key

Press to select the original type registered with **[Type 1(Text):]** or **[Type 2(Photo):]**. When the original type is selected, the corresponding indicator lights.

18. **[Cancel]** key

Press to cancel an operation or return to the previous display.

19. **[OK]** key

Press to set a selected item or an entered numeric value.

20. Number keys

Press to enter numeric values.

21. **[Start]** key

Press to start scanning or sending.

Reading the Display and Using Keys

This section explains how to read the display and use the selection key.

1

Note

- The copy screen is set as the default screen when the machine is turned on. You can change the settings in [**System Settings**]. See *General Setting Guide*.

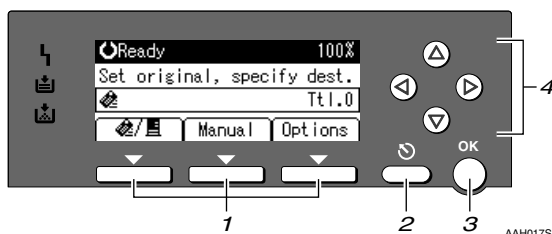

1. Selection keys

Correspond to items at the bottom line on the display.

Example: The E-mail screen

- When the instruction “press [📧/📧]” is given in this manual, press the left selection key.
- When the instruction “press [Manual]” is given in this manual, press the centre selection key.
- When the instruction “press [Options]” is given in this manual, press the right selection key.

2. [Cancel] key

Press to cancel an operation or return to the previous display.

3. [OK] key

Press to set a selected item or an entered numeric value.

4. Scroll keys

Press to move the cursor in each direction, step by step.

When the [▲],[▼],[▶], or [◀] key appears in this manual, press the scroll key of the same direction.

2. Preparations for Use as a Network Scanner

To use the machine as a network scanner, you must make settings required for use as a scanner as well as basic settings for use in a network.

Reference

First, see *General Settings Guide* for details about how to make basic settings, and then make scanner settings.

For more information about settings for sending by e-mail, see *Network Guide*.

Initial Scanner Setup

This section explains all required settings and procedures for using the machine as a network scanner.

Scanner Features

The settings for using the network scanner functions of the machine are listed below. Make the necessary settings.

Note

Make settings for the items marked with ○ if necessary.

❖ Scan Settings

For explanations of settings, see p.12 “Scan Settings”.

Settings			Default	E-mail	Delivery	TWAIN
Scan Settings	Default Scan Settings	Resolution	200dpi	○	○	
		Scan Size	Auto Detect	○	○	
	Original Setting		1 Sided Original	○	○	
	Mixed Orig. Sizes Priority		Off	○	○	
	Orig. Orientation Priority			○	○	
	Original Type Setting		Type 1(Text):	Text (Print)	○	○
Type 2(Photo):			Photo	○	○	

Note

[Original Setting] will be effective only when you have installed the optional ADF capable of scanning both sides of a sheet (ARDF).

❖ **Destination List Settings**

For explanations of settings, see p.14 “Destination List Settings”.

Settings		Default	E-mail	Deliv- ery	TWAIN
Destina- tion List Settings	Destination List Pri- ority	Delivery Server	<input type="radio"/>	<input type="radio"/>	
	Update Server Dest. List	—		<input type="radio"/>	

❖ **Send Settings**

For explanations of settings, see p.14 “Send Settings”.

Settings		Default	E-mail	Deliv- ery	TWAIN
Send Set- tings	TWAIN Standby Time	10 sec.	<input type="radio"/>	<input type="radio"/>	<input type="radio"/>
	File Type Priority	Multi-page:TIFF	<input type="radio"/>		
	Compression	On	<input type="radio"/>	<input type="radio"/>	
	Print&Del. Scanner Journal	On	<input type="radio"/>	<input type="radio"/>	
	Max. E-mail Size	2048KB	<input type="radio"/>		
	Divide & Send E-mail	On (per max. size)	<input type="radio"/>		
	E-mail Informatn. Language	British English	<input type="radio"/>		
	Sender's Name De- fault	None	<input type="radio"/>		

Setting procedure

1 Press the **[User Tools/Counter]** key.

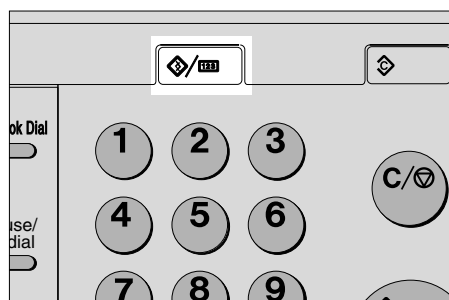

AAH011S

- 2** Select [Scanner Features] using [▲] or [▼], and then press the [OK] key.

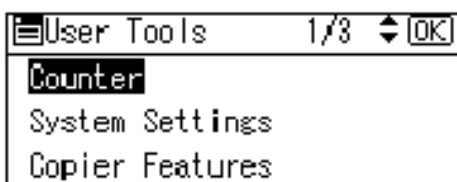

- 3** Select a menu using [▲] or [▼], and then press the [OK] key.

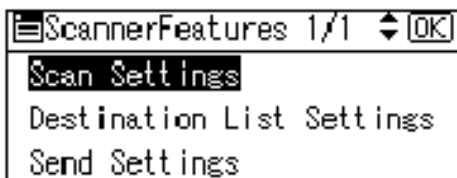

- 4** Select a setting using [▲] or [▼], and then press the [OK] key.

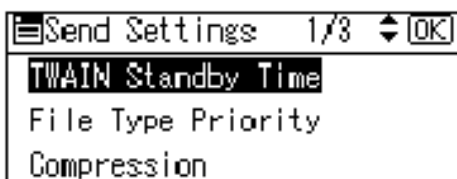

Example: TWAIN Standby Time setting

- 5** Change the settings.

- Select an item using [▲] or [▼], and then press the [OK] key.

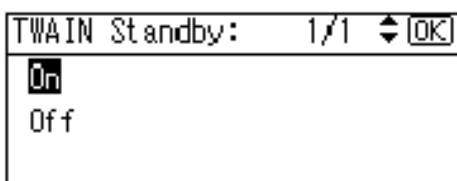

- Enter numbers using the number keys, and then press the [OK] key.

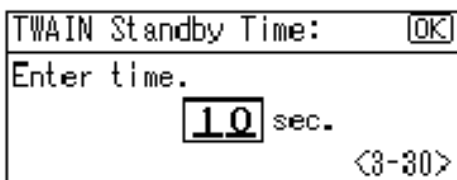

The “programmed” message appears, and then the Send Settings screen returns.

Note

- To cancel changing a setting, press the [Cancel] key. The setting returns to the previous condition.

- 6** Press the [Cancel] key.

The Scanner Features screen reappears.

7 Repeat steps **3** to **6** to make other settings.

8 Press the **[Cancel]** key.

The main menu appears.

Scan Settings

This section explains how to set the defaults for scan settings.

The scan settings consist of the following. For the list about settings and defaults, see p.9 “Scanner Features”.

❖ Default Scan Settings















Resolution and scan size can be set.

- Resolution
Select the resolution from 100dpi, 200dpi, 300dpi, 400dpi, or 600dpi.

- Scan Size
Select the size of the original to be scanned.

When **[Auto Detect]** is selected, the auto detect function of the machine is used to set the original size.

When the size is specified, scanning is performed for that size, regardless of the actual size of the original. The following sizes can be selected:

A3 , A4 , A4 , A5 , A5 , 11 × 17 , 8¹/₂ × 14 , 8¹/₂ × 13 , 8¹/₂ × 11 , 8¹/₂ × 11 , 5¹/₂ × 8¹/₂ , 5¹/₂ × 8¹/₂ , B4 JIS  (Japanese Industrial Standard), B5 JIS , B5 JIS , Custom size





Note

- When **[Custom Size]** is selected, the dimensions of the scan area (width and height) can be specified.
- When selecting **[Custom Size]** for **[Scan Size]**, see p.13 “Selecting a custom size”.

❖ Original Setting

Note

- This setting is available only when you have installed the optional ADF capable of scanning both sides of a sheet (ARDF).

Set the default for whether originals are one-sided or two-sided and if two-sided, the relationship between those sides. When the originals are always the same, set this for the default to make operation easier. You can select **[1 Sided Original]**, **[2 sided Orig.(T toT  )]** (Top to Top), or **[2 Sided Orig.(To toB  )]** (Top to Bottom).

Reference

p.31 “Original Orientation and Scan Area”

❖ Mixed Orig. Sizes Priority

This setting determines whether the original size is to be automatically detected when originals of different sizes are inserted in the ADF. You can select **[On]** or **[Off]**.

Note

- If the original size is specified when scanning, this setting is ignored.
- When **[Off]** is selected, **[Auto Detect]** is selected for **[Scan Size]**, and originals of different sizes are placed in the ADF, the maximum size of the originals is detected as the scan size.

❖ Orig. Orientation Priority

Select the default for original placement orientation. When originals are always positioned the same way, select that orientation as the default to make operation easier.

🔍 Reference

p.31 "Original Orientation and Scan Area"

❖ Original Type Setting

Select the original type registered in **[Type 1(Text):]** or **[Type 2(Photo):]**. The original type that can be registered is as follows:

- Text (Print)
For standard originals containing mainly text (for print)
- Text (OCR)
For standard originals containing mainly text (for OCR)
- Text/Photo
For originals containing a mixture of text and photographs
- Photo
For originals containing photographs and other pictures

📝 Note

- ❑ You can register "Text (Print)" or "Text (OCR)" in **[Type 2(Photo):]**, or "Text/Photo" or "Photo" in **[Type 1(Text):]**.
- ❑ Printer printing is best scanned with Text (Print). Text (OCR) is suitable for higher OCR accuracy.

Selecting a custom size

When selecting **[Custom Size]** as the scan size, follow the procedure below.

- 1** Select **[Custom Size]** on the Scan Size screen using the scroll keys, and then press the **[OK]** key.

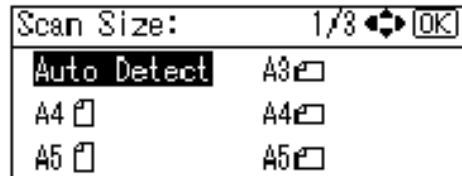

- 2** Enter the width of the original using the number keys.

Enter the value in **[Horiz.]**, and then press the **[OK]** or **[#]** key.

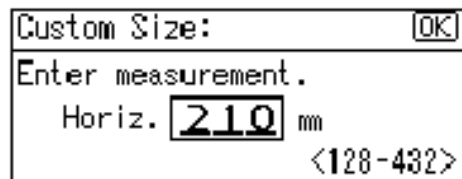

- 3** Enter the height of the original using the number keys.

Enter the value in **[Vert.]**, and then press the **[OK]** or **[#]** key.

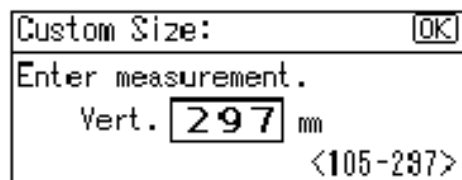

The range of possible dimensions for original sizes is as follows:

- Original Size
Horiz.: 128 - 432 mm(5.1" - 17.0")
Vert.: 105 - 297 mm(4.2" - 11.6")
The "Programmed" message appears, and then the Scan Size screen returns.

- 4** Press the **[User Tools/Counter]** key.

Destination List Settings

This section explains how to set the defaults for the destination list displayed.

The destination list settings consist of the following. For the list about settings and defaults, see p.9 “Scanner Features”.

❖ Destination List Priority

Select a destination list to be displayed when the machine is in the initial state. You can select either **[E-mail]** or **[Delivery Server]**.

❖ Update Server Dest. List

To update the Delivery Server Destination List, press **[Update Server Dest. List]**.

Ordinarily, the Delivery Server Destination List is automatically updated. This function allows updating at any time.

Send Settings

This section explains how to set the defaults for sending settings and how the machine switches to the network TWAIN scanner function.

The send settings consist of the following. For the list about settings and defaults, see p.9 “Scanner Features”.

❖ TWAIN Standby Time

When the machine is being used to send e-mail or functioning as a network delivery scanner, a scanning request to the machine as a TWAIN scanner will switch the machine to the network TWAIN scanner function. This setting determines the delay until the machine switches to the network TWAIN scanner function.

- When **[Off]** is selected, the machine will switch to the network TWAIN scanner function at once.
- When **[On]** is selected, you can enter the delay time with the number keys (3 - 30 seconds). The machine will switch to the network TWAIN scanner function when the time set here passes after the last key operation.

❖ File Type Priority

Select whether to send the file of scanned originals using a single page or multiple pages. When sending using multiple pages, select either TIFF or PDF.

❖ Compression

This setting determines whether a scan file is to be compressed.

Note

- The actual time required for file transfer will vary depending on the file size and network load.
- Compression reduces the time required for transferring the scan file.

❖ Print&Del. Scanner Journal

Select whether to print the Scanner Journal automatically when the number of delivered e-mails reaches 50.

Important

- When the main power switch is turned off, all records are deleted.

 **Note**

- When **[On]** is selected, all records are deleted after printing. When **[Off]** is selected, records that exceed the limit are automatically deleted from the oldest records.

❖ Max. E-mail Size

Select whether the size of an e-mail with a scan file attached is limited or not.

When **[On]** is selected, enter the size limit (64 - 8580 KB) with the number keys.

 **Note**

- When the SMTP limits the size, match that setting.

❖ Divide&Send Mail

This function is effective only when **[On]** is selected for **[Max. E-mail Size]**.

When an e-mail with an attached file exceeds the size specified in **[Max. E-mail Size]**, select whether or not to divide the file and send using more than one e-mail. Select either **[On (per page)]**, **[On (per max. size)]**, or **[Off]**. When **[On (per max. size)]** is selected, enter the maximum number of divisions (2-130) with the number keys.

 **Note**

- When **[Multi-page:TIFF]** or **[Multi-page:PDF]** is selected for **[File Type Priority]**, an attached scan file will not be divided even if **[On (per page)]** is selected.
- When **[On (per max. size)]** is selected, some received files may not be able to be restored, depending on the type of e-mail software.

- When **[Off]** is selected, the e-mail is not sent if its size exceeds the limit, and an error message appears. The scan file is discarded.

- Set the maximum e-mail size within the capacity of the SMTP server.

❖ E-mail Informatn. Language

Select a language for E-mail Information Language for message, date, key operator's e-mail address to be sent.

Select one of the following 20 languages: British English, American English, German, French, Italian, Spanish, Dutch, Portuguese, Polish, Czech, Swedish, Finnish, Hungarian, Norwegian, Danish, Japanese, Simplified Chinese, Traditional Chinese, Russian, and Hangul.

 **Note**

- "E-mail Information Language" is as follows (Example: When **[British English]** is selected): "This E-mail was sent from.", "Scan Date", and "Queries to:". These messages cannot be changed.

❖ Sender's Name Default

Select whether to register an administrator as a sender or to specify a sender each time e-mail is sent. If the key operator code has been set, enter the code with the number keys, and then press the **[OK]** key.

- Select **[None]** to specify the sender each time.
- Select **[Key Op's E-mail Address]** to specify an administrator as the sender.

Important

- It is recommended that a sender's password be set to prevent the sender's name from being misused.
- When **[On]** is selected for **[Key Operator Code]** in **[Key Operator Tools]** of **[System Settings]** and **[On: Partial]** is set for the range, enter the key operator code when **[Sender's Name Default]** in **[Send Settings]** of **[Scanner Features]** is selected. For more information about System Settings, see *General Settings Guide*.

Installing Software

The machine comes with three CD-ROMs containing various software.

The CD-ROM labeled “Scanner Driver & Document Management Utilities” contains the necessary software to use the machine as a network scanner. The CD-ROM labeled “Printer Driver & Utilities” contains the necessary software to use the machine as a printer.

This section explains the software to use the machine as a network scanner.

2

Auto Run Program

When the CD-ROM is inserted into a client computer in Windows 95/98/Me/2000/XP, or Windows NT 4.0, the installer starts automatically (Auto Run) to install the TWAIN driver and various software.

Note

- Auto Run might not automatically work with certain operating system settings. In this case, launch “Set up.exe” located in the CD-ROM root directory.
- If you want to install the software without using Auto Run, hold down the **[Shift]** key while inserting the CD-ROM. Keep the **[Shift]** key held down until the client computer has finished accessing the CD-ROM.
- If **[Cancel]** is pressed during installation, the installation will be stopped and all the remaining software will not be installed. If **[Cancel]** has been pressed, reinstall the remaining software after restarting the client computer.

Limitation

- For installation in Windows 2000/XP, or Windows NT 4.0, log in as a member of the administrators group.

The installing sequence using Auto Run is as follows.

Installation Sequence

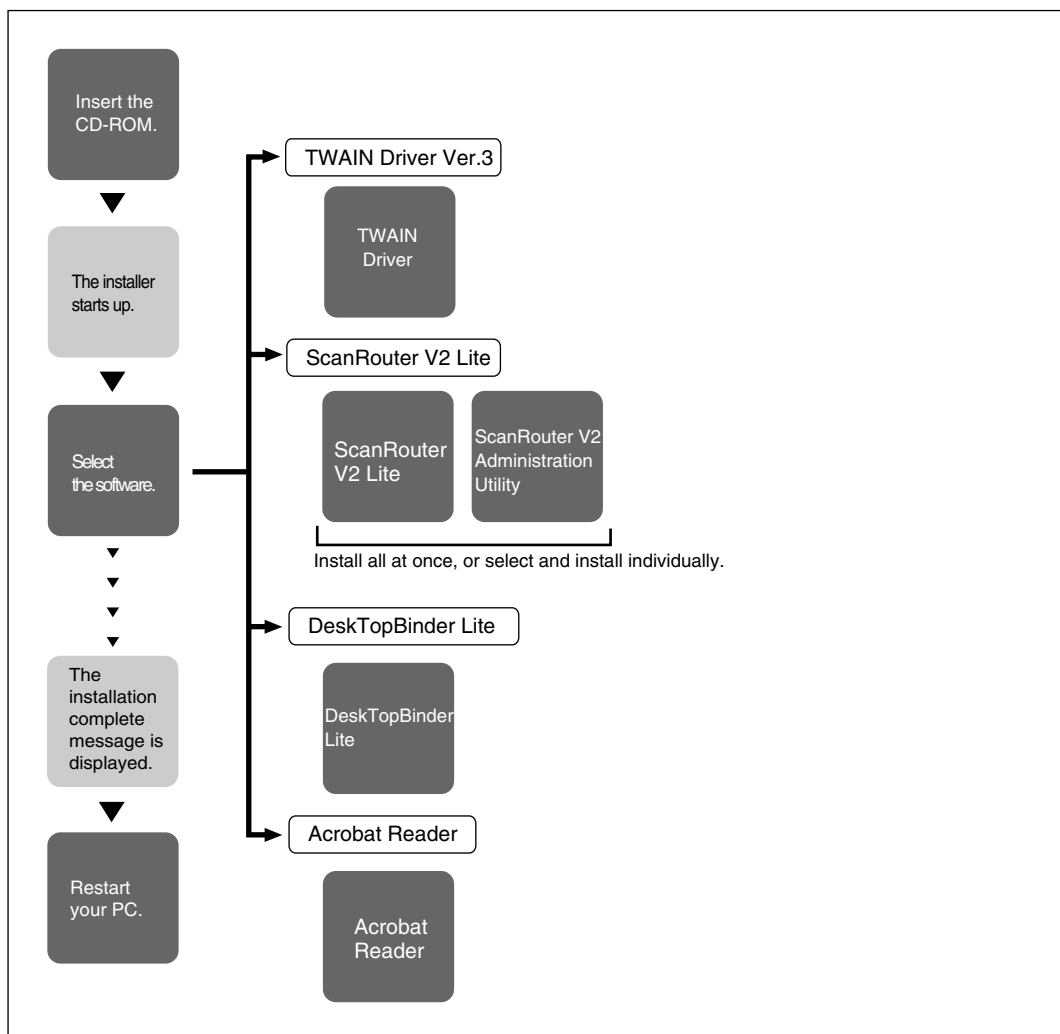

AKN001S

For information about the software that can be installed by Auto Run, see p.21 "Software Supplied on CD-ROM".

Software for Using a Network TWAIN Scanner

To use the machine as a network TWAIN scanner, it is essential to install the TWAIN driver.

If you do not have applications that work with TWAIN, it is necessary to also install DeskTopBinder Lite. For information about the installation of DeskTopBinder Lite, see p.21 “DeskTopBinder Lite”.

Preparation

Before installation, check the operating environment for the TWAIN driver. See p.21 “Type2018 TWAIN Driver”.

Using Windows 95/98/Me/2000/XP, or Windows NT 4.0

Install the TWAIN driver using Auto Run.

- 1** Start Windows, and then insert the supplied CD-ROM labeled “Scanner Driver & Document Management Utilities” into the CD-ROM drive of the client computer.

The CD-ROM Launcher screen appears.

Reference

If the installer does not start automatically, see p.17 “Auto Run Program”.

- 2** Click [TWAIN Driver].

The Software Setup screen appears.

- 3** The installer of the TWAIN driver starts. Follow the instructions on the screen.

Note

- When the installation is complete, a message to prompt you to restart the client computer may appear. In this case, restart the client computer.

- After the installation is complete, the “Type2018 TWAIN V3” folder is in the “Program” folder on the Start menu. Help can be displayed from here.
- Be sure to read “Readme.txt” before use.

Software for Using the Network Delivery Scanner Function

To use the machine as a network delivery scanner, it is essential to install ScanRouter V2 Lite on the delivery server. To check an in-tray or retrieve files, it is necessary to install DeskTopBinder Lite on the client computer.

Use Auto Run for installation.

2

Preparation

Before installation, check the system requirements for the software. See p.21 “Software Supplied on CD-ROM”.

1 Start Windows, and then insert the supplied CD-ROM labeled “Scanner Driver & Document Management Utilities” into the CD-ROM drive of the client computer.

The CD-ROM Launcher screen appears.

2 Click the key of the software to be installed.

- Click [**ScanRouter V2 Lite**], and then the ScanRouter V2 Lite Setup screen appears.
- Click [**DeskTopBinder Lite**], and then the DeskTopBinder Lite Setup screen appears.

3 Click [**ScanRouter V2 Lite**] or [**DeskTopBinder Lite**]. The installer of the software starts. Follow the instructions on the screen.

Reference

For information about the subsequent installation procedure, see *Setup Guide* that can be displayed from the Setup screen of the respective software.

DeskTopBinder Lite

Use Auto Run for installation.

Preparation

Before installation, check the system requirements for DeskTopBinder Lite. See p.22 “DeskTopBinder Lite”.

- 1 Start Windows, and then insert the supplied CD-ROM labeled “Scanner Driver & Document Management Utilities” into the CD-ROM drive of the client computer.**

The CD-ROM Launcher screen appears.

- 2 Click [DeskTopBinder Lite].**

The DeskTopBinder Lite Setup screen appears.











- 3 Click [DeskTopBinder Lite]. The Installer of the DeskTopBinder Lite starts. Follow the instructions on the screen.**

Reference

For information about the subsequent installation procedure, see *Setup Guide* that can be displayed from the Setup screen of DeskTopBinder Lite.

Software Supplied on CD-ROM

List of files

 CD-ROM Drive	 Wizard for the TWAIN driver and utilities		
	 Drivers	 Twain	TWAIN driver for Windows 95/98/Me/2000/XP, Windows NT 4.0
	 Utility	 RouterV2	 ScanRouter V2 Lite ,  ScanRouter V2 Administration Utility
		 DeskV2	 DeskTopBinder Lite
	 Acroread	Acrobat Reader	

Type2018 TWAIN Driver

This driver is required to scan an original on the machine.

To use the machine as a network TWAIN scanner, this driver must be installed.

❖ File storage folder

The files are stored in the following folder on the CD-ROM provided with this machine:

`\DRIVERS\TWAIN`

❖ System requirements

📌 Limitation

- Under Windows NT with RISC-based processors (MIPS R series, Alpha AXP, or PowerPC), this driver is not available.
- Hardware
PC/AT compatible
- CPU
Pentium or faster (Pentium 150 MHz or faster recommended)
- Operating system
Microsoft Windows 95 (OSR 2 or later)
Microsoft Windows 98
Microsoft Windows Millennium Edition
Microsoft Windows 2000 Professional
Microsoft Windows 2000 Server
Microsoft Windows XP Home Edition
Microsoft Windows XP Professional
Microsoft Windows NT Workstation 4.0 (Service Pack 5 or later)
Microsoft Windows NT Server 4.0 (Service Pack 5 or later)
- Memory
Operating system minimum operation memory + 8 MB (64 MB or more recommended)
- Hard disk space
100 MB or more
- Display resolution
800 × 600 pixels, 256 colours or higher
- Network protocol
TCP/IP

DeskTopBinder Lite

DeskTopBinder Lite is to be installed on the client computers for integration and management of various kinds of files such as scan files, files created with applications, and existing files. This software allows you to use various functions for scan files stored in the Document Server, e.g., viewing stored files. Also, with ScanRouter V2 Lite, you can view the files stored in in-trays of the delivery server or use other functions for stored files.

🔍 Reference

See DeskTopBinder Lite Help or the manuals for DeskTopBinder Lite.

❖ File storage folder

The files are stored in the following folder on the CD-ROM provided with this machine:

`\UTILITY\DESKV2`

❖ System requirements

- Hardware
PC/AT compatible
- CPU
Pentium 133 MHz or faster (Pentium II 266 MHz or faster recommended)
- Operating system
Microsoft Windows 95 (OSR 2 or later)
Microsoft Windows 98
Microsoft Windows Millennium Edition
Microsoft Windows 2000 Professional (Service Pack 1 or later)
Microsoft Windows 2000 Server (Service Pack 1 or later)
Microsoft Windows XP Home Edition
Microsoft Windows XP Professional
Microsoft Windows Server 2003 Standard Edition
Microsoft Windows Server 2003 Enterprise Edition
Microsoft Windows Server 2003 Web Edition
Microsoft Windows NT Workstation 4.0 (Service Pack 5 or later)
Microsoft Windows NT Server 4.0 (Service Pack 5 or later)
- Memory
48 MB or more (128 MB or more recommended)
- Hard disk space
50 MB or more (200 MB or more recommended)
- Display resolution
800 × 600 pixels, 64K colours or higher
- Network protocol
TCP/IP

❖ Software installed with DeskTopBinder Lite

- Auto Document Link
Auto Document Link on the client computer monitors in-trays of the delivery server. In addition, the files delivered to in-trays can be retrieved or notification of the arrival of a file can be received at the client computer with this software.
- Function Palette
Function Palette allows you to use functions such as the network TWAIN scanner, printing, printing preview, sending files by e-mail, or sending faxes without starting DeskTopBinder Lite. You must make settings in advance in the **[Extended Features...]** to use Function Palette. See the DeskTopBinder manuals for more information.
- Extended Features Wizard
You can make settings equivalent to the settings made with **[Extended Features...]** of the **[Tools]** menu with Extended Features Wizard. See the DeskTopBinder manuals for more information.

ScanRouter V2 Lite

ScanRouter V2 Lite is to be installed on the delivery server. Scan files can be sorted in the delivery server, stored in specified in-trays, or saved in folders of client computers on the same network.

Reference

See ScanRouter V2 Lite Help or the manuals for ScanRouter V2 Lite.

❖ File storage folder

The files are stored in the following folder on the CD-ROM provided with this machine:

`\UTILITY\ROUTERV2`

❖ System requirements

Limitation

- When installing the software in Windows NT Server or Windows 2000 Server, a stand-alone server must be used. Do not use the primary domain controller or backup domain controller.
- If you install this software in an operating system, such as Windows NT Workstation and Windows 2000 Professional, in which a client server is not permitted to be used in a network, you may violate the license agreement of Microsoft Corporation.

- Hardware
 - PC/AT compatible
- CPU
 - Pentium 200 MHz or faster (Pentium II 350 MHz or faster recommended)
- Operating system
 - Microsoft Windows 95 (OSR 2 or later)
 - Microsoft Windows 98
 - Microsoft Windows Millennium Edition
 - Microsoft Windows 2000 Professional (Service Pack 1 or later)
 - Microsoft Windows 2000 Server (Service Pack 1 or later)
 - Microsoft Windows XP Home Edition
 - Microsoft Windows XP Professional
 - Microsoft Windows NT Workstation 4.0 (Service Pack 5 or later)
 - Microsoft Windows NT Server 4.0 (Service Pack 5 or later)
- Memory
 - 64 MB or more (128 MB or more recommended)
- Hard disk space
 - Minimum free space required for installing: 200 MB

Note

- In addition to the space required for installation, the hard disk should have at least 500 MB of free space for files.
- Network protocol
 - TCP/IP

❖ Software installed with ScanRouter V2 Lite

- ScanRouter V2 Administration Utility

ScanRouter V2 Administration Utility manages the delivery system run by ScanRouter V2 Lite.

You can register destination and sender information for the scan files in the delivery server. In addition, you can perform maintenance for free disk space monitoring, error log recording, and other features of the delivery server.

Note

- ScanRouter V2 Administration Utility can be installed not only on the delivery server but also on client computers. To install it, click [**ScanRouter V2 Administration Utility**] on the ScanRouter V2 Lite Setup screen.

3. Setting Originals



This chapter explains the procedure for placing originals on the exposure glass and in the ADF, and setting the original scan area and orientation according to the placement method.

To correctly display the top/bottom orientation of the scanned original on a client computer, the placement of the original and the settings made on the control panel and scanner driver must match.

Placing Originals

There are two orientations for placing the original. See the table below.

Note

- Normally, an original is  or , but in the table below, a square original is used to make original orientation easy to understand. If the actual shape of the original is different, the combination of original orientation and the orientation specified on the control panel or scanner driver does not change.

◆ Specifying original orientation and setting originals

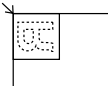
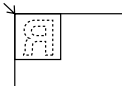
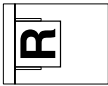
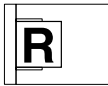
1 An original to be scanned				
2 Decide the placement method.	Exposure glass		ADF	
3 Place the original. (There are two original orientations.)	Place the original so that the top edge touches the top left of the exposure glass. 	Place the original so that the top edge touches the rear of the exposure glass. 	Place the top edge of the original first. 	Place the original so that the top edge touches the back of the ADF. 

4 Specify the orientation. When scanning using the e-mail function or the delivery scanner function (Specified on the control panel screen)	
	When scanning using the TWAIN scanner function (Specified in the Scanner Control dialog box)
5 The original displayed on a computer	

Placing on the Exposure Glass

Originals which do not fit into the ADF, such as sheets with glued-on parts, books, etc., can be placed directly on the exposure glass for scanning.

Note

- For information about the originals which can be placed on the exposure glass, see *Copy Reference*.

1 Lift the exposure glass cover or the ADF.

Note

- Lift the exposure glass cover or ADF more than 30 degrees. The opening/closing action triggers the automatic original size detection process.

2 Place the original on the exposure glass with the side to be scanned facing down. Align the original with the back left corner mark.

There are two original orientations.

- ◆ When placing the original so that the top edge touches the rear of the exposure glass

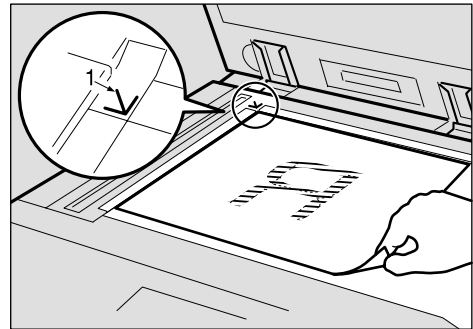

AAH004S

1. Positioning mark

- ❖ When placing the original so that the top edge touches the top left of the exposure glass

When using the machine as a network TWAIN scanner, this orientation is the standard setting for the TWAIN driver. Normally, use this orientation for placing originals.

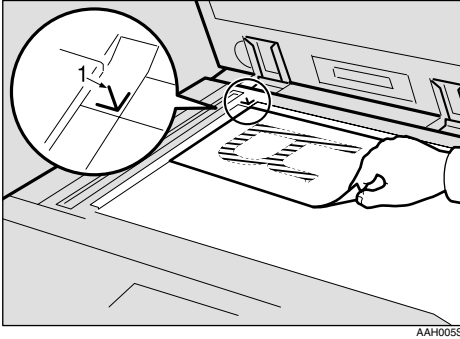

1. Positioning mark

- 3 Lower the exposure glass cover or the ADF.
- 4 Select the original orientation according to the orientation of the placed original.

Reference

p.27 "Specifying original orientation and setting originals"

Proceed to p.31 "Original Orientation and Scan Area".

Placing in the Auto Document Feeder

The ADF allows you to place multiple originals at one time. Originals placed in the ADF can be scanned on one side or both sides.

Note

- The duplex function is available only when you have installed the optional ADF capable of scanning both sides of a sheet (ARDF).

- ❖ **Originals that can and cannot be placed in the ADF**

For information about the originals that can and cannot be placed in the ADF, see *Copy Reference*.

Attempting to use unsuitable originals in the ADF can lead to a mis-feed and damage to the originals. Place such originals directly on the exposure glass.

Important

- For information about original sizes that can be detected automatically and notes on placing originals in the ADF, see *Copy Reference*.

- 1 Adjust the original guide to match the size of the originals.
- 2 Place the originals with the side to be scanned facing up. (For originals which are to be scanned on both sides, the first side should face up.)

There are two orientations.

- ❖ **When placing the originals so that the top edges touch the back of the ADF**

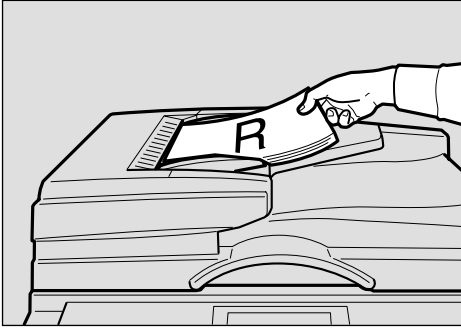

AAH006S

- ❖ **When placing the top edges of the originals first**

When using the machine as a network TWAIN scanner, this orientation is the standard setting for the TWAIN driver. Normally, use this orientation for placing originals.

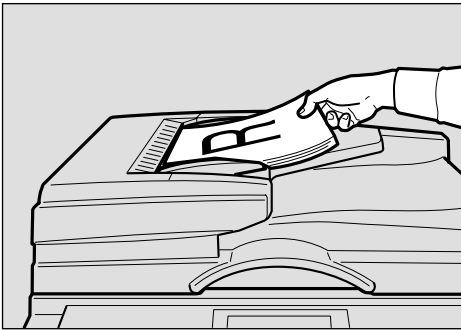

AAH007S

Note

- ❑ Originals of the same width and different length can be placed at the same time. Place the originals as shown:

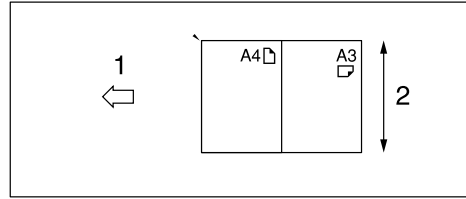

AAH022S

1. ADF placement orientation

2. Height

Reference

p.32 "Mixed size selection"

- ❑ Originals are scanned in the inserted order, starting with the topmost page.

3 Select the original orientation according to the orientation of the placed originals.

Reference

p.27 "Specifying original orientation and setting originals"

Proceed to p.31 "Original Orientation and Scan Area".

Original Orientation and Scan Area

To correctly display the top/bottom orientation of a scanned original on a client computer, original orientation must be set when placing the original.

When using the e-mail function or the network delivery scanner function, settings are made on the control panel of the machine. When using the machine as a network TWAIN scanner, settings are made with the TWAIN driver.

Note

- The difference between scanning with the TWAIN scanner function and the e-mail function or the network delivery scanner function is shown in the following table.

	TWAIN Scanner	E-mail/Network Delivery Scanner
Auto Detect Non-Mixed Original Sizes	A whole batch of originals is scanned using the size of the first original.	Auto detection is used to determine the size of each original placed on the exposure glass. A batch of originals placed in the ADF is scanned using the size of the largest original placed.

	TWAIN Scanner	E-mail/Network Delivery Scanner
Auto Detect Mixed Original Sizes	Auto detection is used to determine the size of each original.	
Size Specification	When an original is smaller than the specified size, a blank space appears in the resulting image.	

For E-mail and a Network Delivery Scanner

- 1** To make settings for original orientation, one-sided/two-sided combination, and mixed original sizes, press [Options].

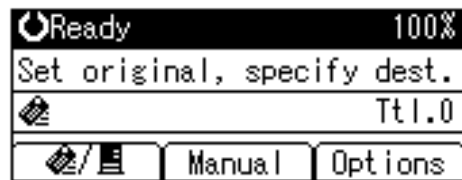

Note

- The default can be changed using the initial scan settings [Original Setting], [Mixed Orig. Sizes Priority], and [Orig. Orientation Priority]. See p.12 "Scan Settings".

- ❑ The duplex function is available only when you have installed the optional ADF capable of scanning both sides of a sheet (ARDF).

Orientation selection

- 1 Select [Original Orientation] using [▲] or [▼], and then press the [OK] key.

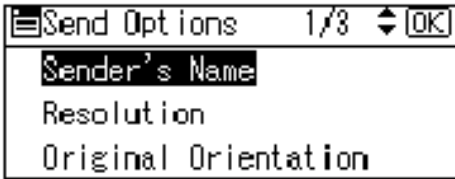

- 2 Select the icon for the same orientation as the actual orientation of the original, [R R] or [B B], and then press the [OK] key.

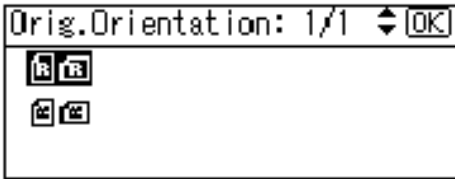

The "Accepted" message appears, and then the Send Option screen returns.

One-sided original/Two-sided original selection

- 1 Select [Original Setting] using [▲] or [▼], and then press the [OK] key.

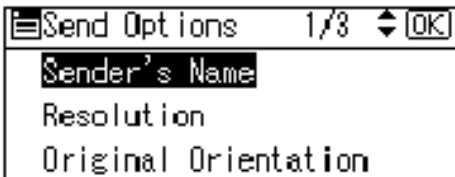

- 2 When scanning one-sided originals, select [1 Sided Original] using [▲] or [▼], and then press the [OK] key. When scanning two-sided originals, select [2 Sided Orig.(T to T)] or [2 Sided Orig.(To to B)] using [▲] or [▼] according to the binding side of the original, and then press the [OK] key.

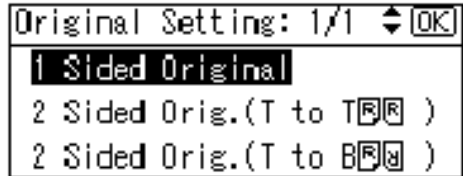

Top to top original:



Top to bottom original:

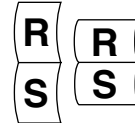

The "Accepted" message appears, and then the Send Options screen returns.

Mixed size selection

- 1 Select [Mixed Sizes] using [▲] or [▼], and then press the [OK] key.

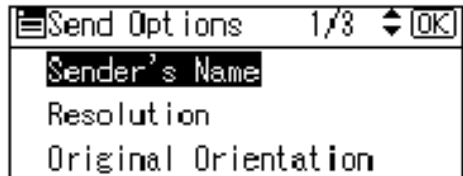

- ② When originals of the same width and different length are placed, select **[On]** using **[▲]** or **[▼]**, and then press the **[OK]** key.

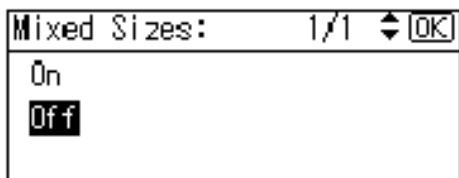

The “Accepted” message appears, and then the Send Options screen returns.

Note

- When **[Off]** is selected and **[Auto Detect]** is selected for **[Scan Size]**, if originals of different sizes are placed in the ADF, the size of the largest original placed is detected and set as the scan size. For originals smaller than this size, a blank space will appear in the resulting image.
- ③ Press the **[Cancel]** key.
The E-mail screen appears.

For a Network TWAIN Scanner

- ① Open the scanner properties dialog box.

Reference

p.66 “Scanning Originals”

- ② Select the position from the **[Document]** list in the **[Document]** area.

- ③ Select **[←R→/←B→]** or **[←R→/←B→]** in the **[Orientation:]** list.

Reference

p.27 “Specifying original orientation and setting originals”

- ④ When the originals are placed in the ADF, select **[Simplex]** or **[Duplex]** in the **[Side:]** list.

Note

- The duplex function is available only when you have installed the optional ADF capable of scanning both sides of a sheet (ARDF).
- If originals of different sizes are placed in the ADF, specify the original size or detection method in the **[Size:]** box. If **[Auto detection (Uni-size)]** is selected, all originals are scanned using the size of the first page. If **[Auto detection (Multi-size)]** is selected, all originals are scanned according to their own width. For both Uni-size and Multi-size, all originals are scanned using their own length.

Scanning Originals in Several Times using the Exposure Glass

1 Place the originals.

 **Reference**
p.27 "Placing Originals"

 **Note**

Originals are scanned in order.
Place them from the first page.

2 Make settings for scanning area and original orientation.

 **Reference**
p.31 "Original Orientation and Scan Area"



3 Make settings for sending by e-mail or delivering.

 **Reference**
p.37 "Procedure for Sending by E-mail"
p.54 "Delivery Procedure"

4 Press the **[Start]** key.



5 When there are additional originals to scan, place them and press the **[Start]** key.

Repeat this step until all originals are scanned.

6 After all originals are scanned, press the **[#]** key.
Sending will start.

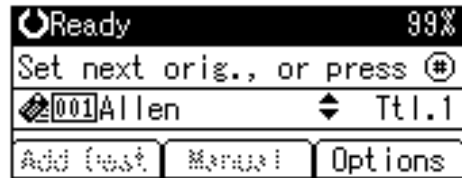

4. Sending Scan Files by E-mail

Scan files can be sent from this machine to a specified destination using e-mail. This chapter explains the preparation for sending scan files by e-mail, various display screens, procedures for sending, and how to check the sending result when this function is used.

Preparation for Sending by E-mail

To send by e-mail system, the preparation described below is required.

Note

- ❑ Set up an e-mail server on the network in advance. For information about setting up an e-mail server, see the instruction manuals of the e-mail server to be used and the software to be installed.

1

Connect to Network

Connect the machine to the network with an Ethernet cable or IEEE 1394 (optional) cable, or use Wireless LAN (optional).

See *Network Guide*.

2

Make System Settings

Make the network settings, settings for sending e-mail such as for the SMTP server and TCP/IP, and the destination (sender) settings in System Settings.

See *Network Guide* and *General Settings Guide*.

3

Make Scanner Settings

Make settings for sending e-mail such as the file type priority and sender's default.

See p.14 "Send Settings".

E-mail Screen

These screens are shown when using the machine for e-mail .

❖ Main display

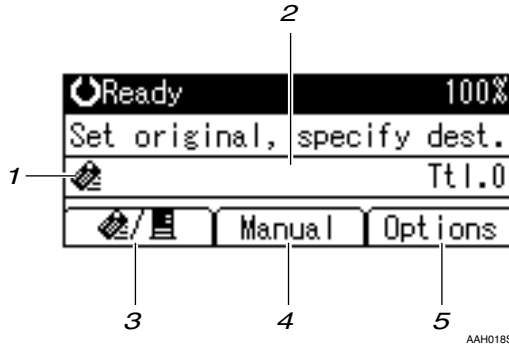

❖ When a destination is selected.

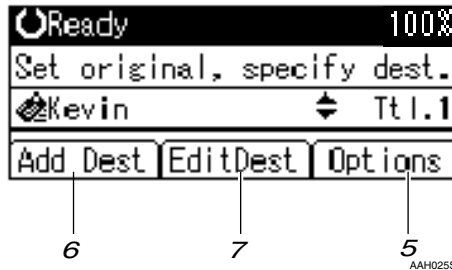

1. E-mail icon (✉)

Indicates that the E-mail screen is displayed.

2. Destination field

Displays the selected destination. If multiple destinations are selected, the destinations are displayed in the order they were selected by pressing **[▲]** or **[▼]**.

📌 Note

- Press the **[Check Destination]** key to check the selected destination.

3. [✉/📡]E-mail/Network Delivery Scanner

Press to switch between the e-mail function and the network delivery scanner function.

4. [Manual]

When specifying a destination that is not registered, press **[Manual]**, and then enter the e-mail address of the destination using the Quick Dial keys.

5. [Options]

Press to make the scan settings such as resolution or scan size, the sender, the subject of the e-mail to be sent, and the file type of the scan file attached to the e-mail if necessary.

6. [Add Dest]

When selecting multiple destinations after a manual entry of an e-mail address, press **[Add Dest]**, and then enter the e-mail address of the destination.

7. [EditDest]

When changing an e-mail address that has been entered, press **[EditDest]**, and then enter the new e-mail address.

Sending Scan Files by E-mail

Procedure for Sending by E-mail

Scan files are sent after specifying scan settings and destinations.

- 1 Press the **[Scanner]** key.

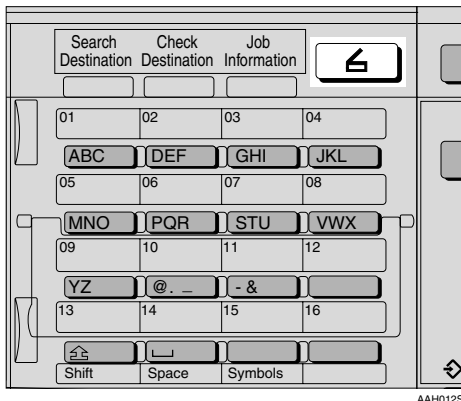

AAH012S

- 2 If the user codes are set, enter a user code using the number keys, and then press the **[#]** key.

The initial scanner screen appears.

Reference

For information about user codes, see *General Settings Guide*.

- 3 If the Network Delivery Scanner screen appears, press **[Network Delivery]** to switch to the E-mail screen.



The E-mail screen appears.

- 4 Make sure that no previous settings remain.

Note

- If a previous setting remains, press the **[Clear Modes]** key.

- 5 Place the original, and then make the scan settings and settings for orientation if necessary.

Reference

- p.12 "Scan Settings"
- p.27 "Setting Originals"

Making the settings

- 1 Press **[Options]**.
- 2 Select items such as resolution and original size using **[▲]** or **[▼]**, and then change their settings.

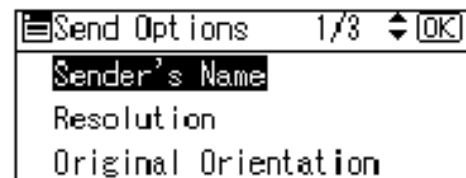

Scan settings can be made in the same way as default scan settings. See p.12 "Scan Settings".

- 3 Press the **[Cancel]** key.

The E-mail screen appears.

- 6 Specify the destination

To specify a destination, you can select it using the Quick Dial key, search for and select it from the Destination List, select it by specifying a registration number, or enter the e-mail address directly.

Using a Quick Dial key to select a destination

- 1 Press the Quick Dial key in which the destination is registered.

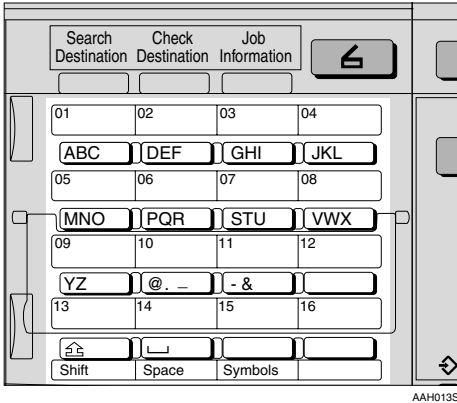

AAH013S

Reference

For more information about how to register the destination, see *General Settings Guide*.

- 2 To select more destinations, repeat step 1.



Note

- To deselect a destination, press **[▲]** or **[▼]** to display the destination in the Destination field, and then press the **[Clear/Stop]** key.

Searching to select a destination by name

- 1 Press the **[Search Destination]** key.

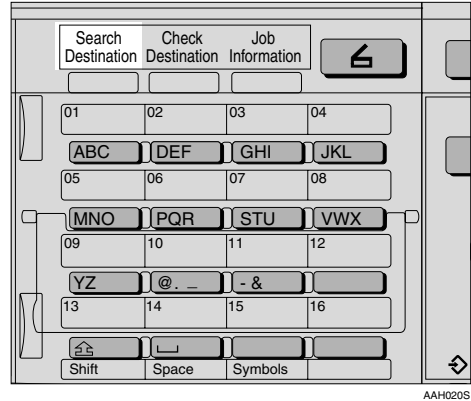

AAH020S

- 2 Select **[Search by Name]** using **[▲]** or **[▼]**, and then press the **[OK]** key.

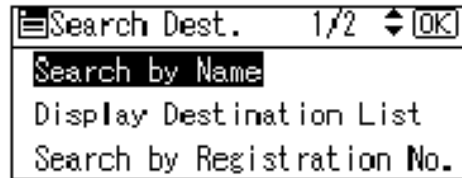

- 3 Enter the beginning of the destination name, and then press the **[OK]** key twice.

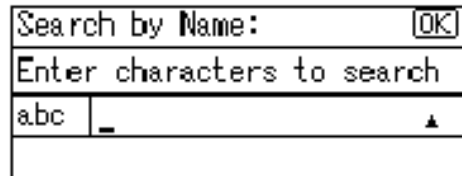

Note

- Enter the first character or characters of the destination name.
- It is necessary to differentiate between uppercase and lowercase.

Reference

For information about how to enter characters, see *General Settings Guide*.

- ④ Select the destination using **[▲]** or **[▼]**, and then press the **[OK]** key.

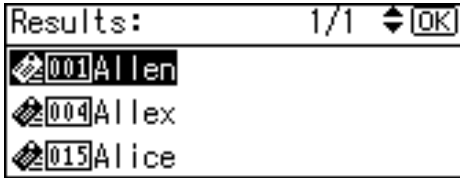

- ⑤ To select more destinations, repeat steps ① to ④.

Note

- To deselect a destination, press **[▲]** or **[▼]** to display the destination in the Destination field, and then press the **[Clear/Stop]** key.

Selecting a destination from Destination List

- ① Press the **[Search Destination]** key.

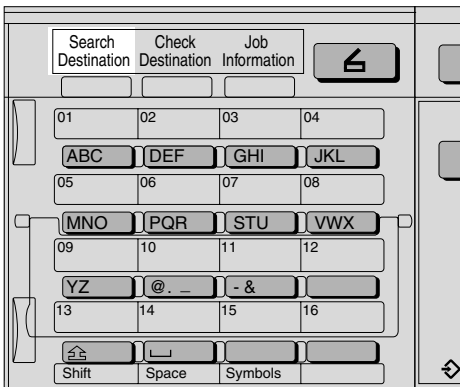

AAH020S

- ② Select **[Display Destination List]** using **[▲]** or **[▼]**, and then press the **[OK]** key.

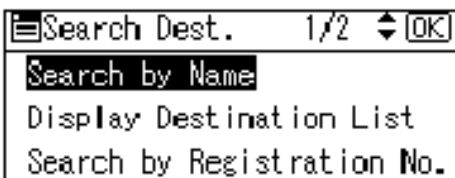

- ③ Select the destination using **[▲]** or **[▼]**, and then press the **[OK]** key.

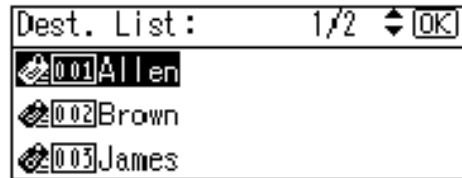

- ④ To select more destinations, repeat steps ① to ③.

Note

- To deselect a destination, press **[▲]** or **[▼]** to display the destination in the Destination field, and then press the **[Clear/Stop]** key.

Searching to select a destination by registration number

- ① Press the **[Search Destination]** key.

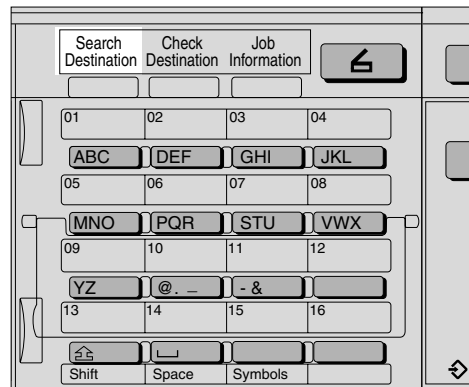

AAH020S

- ② Select **[Search by Registration No.]** using **[▲]** or **[▼]**, and then press the **[OK]** key.

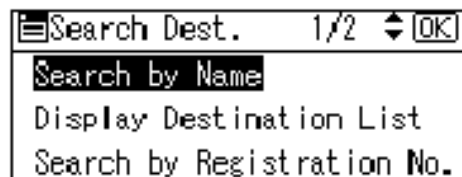

- ③ Enter a 3-digit registration number that has been assigned to a destination using the number keys, and then press the [OK] key.



- ④ Press the [OK] key.

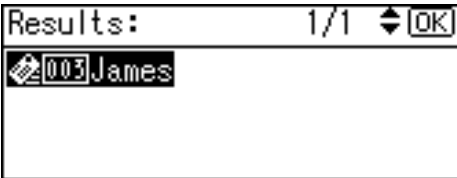

- ⑤ To select more destinations, repeat steps ① to ④.

Note

- To deselect a destination, press [▲] or [▼] to display the destination in the Destination field, and then press the [Clear/Stop] key.

Searching to select a destination by e-mail address

- ① Press the [Search Destination] key.

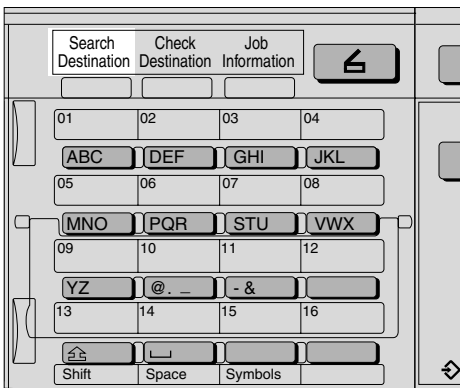

AAH020S

- ② Select [Search by E-mail Address] using [▲] or [▼], and then press the [OK] key.

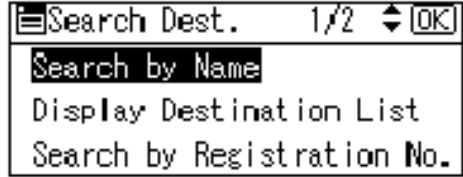

- ③ Enter the beginning of the e-mail address, and then press the [OK] key twice.

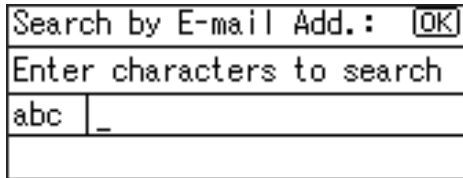

Note

- Enter the first character or characters of the destination name.
- It is necessary to differentiate between uppercase and lowercase.

Reference

For information about how to enter characters, see *General Settings Guide*.

- ④ Select the destination using [▲] or [▼], and then press the [OK] key.



- ⑤ To select more destinations, repeat steps ① to ④.

Note

- To deselect a destination, press [▲] or [▼] to display the destination in the Destination field, and then press the [Clear/Stop] key.

Manual entry of an e-mail address

- ❶ Press **[Manual]**.
- ❷ Enter the e-mail address.

E-mail Address:	[OK]
Enter E-mail address	
abc	_

Note

- Letters, number, and periods can be used. The symbols ()\,;:" cannot be used.

Reference

For information about how to enter characters, see *General Settings Guide*.

- ❸ Press the **[OK]** key.

Note

- To change an e-mail address that has been entered, press **[EditDest]**. The E-mail Address screen appears. Enter the new e-mail address, and then press the **[OK]** key.
 - If the entered destination is longer than the Destination field, the address will be omitted and [...] is displayed instead.
- ❹ To enter more destinations, press **[Add Dest]**, and then repeat steps ❶ to ❸.

Note

- To deselect a destination, press **[▲]** or **[▼]** to display the destination in the Destination field, and then press the **[Clear/Stop]** key.

Checking selected destinations

- ❶ Check the selected destinations in the Destination field.

Note

- When multiple destinations are selected, the selected destinations are displayed in the order they were selected by pressing **[▲]** or **[▼]**.
- Press the **[Check Destination]** key to check the selected destination.

Check Dest.:	1/1	[OK]
<input checked="" type="checkbox"/> allen@abcdef.ghi.jk <input type="checkbox"/> 001Allen		

- ❷ Select the file type if necessary.

- ❶ Press **[Options]**.
- ❷ Select **[File Type]** using **[▲]** or **[▼]**, and then press the **[OK]** key.

Send Options	1/3	[OK]
<input checked="" type="checkbox"/> Sender's Name <input type="checkbox"/> Resolution <input type="checkbox"/> Original Orientation		

- ❸ Select the file type of the file to be attached to the e-mail using **[▲]** or **[▼]**, and then press the **[OK]** key.

File Type:	1/1	[OK]
<input type="checkbox"/> Single page:TIFF <input checked="" type="checkbox"/> Multi-page:TIFF <input type="checkbox"/> Multi-page:PDF		

The "Accepted" message appears, and then the Send Options screen returns.

- ❹ Press the **[Cancel]** key.

8 Specify the e-mail sender.

To specify a sender, you can select it using the Quick Dial key, search for and select it from the Destination List, or select it by specifying a registration number.

- 1 Press [Options].
- 2 Select [Sender's Name] using [▲] or [▼], and then press the [OK] key.

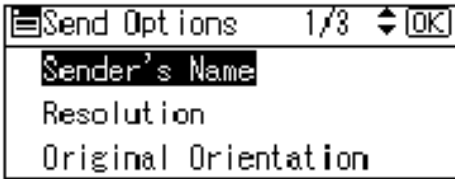

Note

- Step 8 can be omitted if [Key Op's E-mail Address] is specified for [Sender's Name Default] in [Send Settings] of [Scanner Features].
- When a sender is selected, the sender name is automatically placed in the From field of the e-mail so that the sender can be identified by the recipient.
- To prevent misuse of a sender name, we recommend you set a sender's password for that sender name.
- Be sure to select or enter a sender name. Otherwise the key operator's e-mail address is used as the sender name. See *General Settings Guide*.

Using a Quick Dial key to select a sender

- 1 Press the Quick Dial key in which the sender is registered.

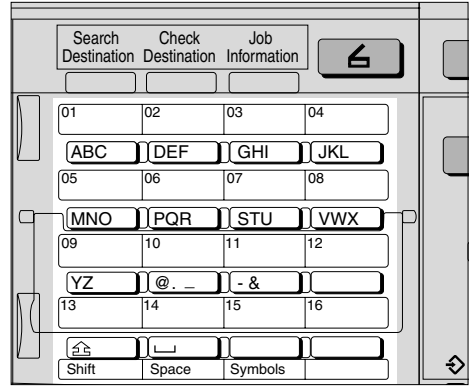

Reference

For more information about how to register the destination, see *General Settings Guide*.

Note

- When a sender's password is set, a screen for entering the sender's password appears. Enter the sender's password using the number keys, and then press the [OK] or [#] key. If the password entered is correct, the sender name is displayed.

- 2 Press the [OK] key.

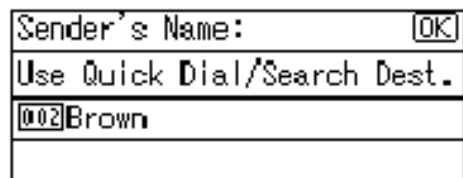

The "Accepted" message appears, and then the Return Receipt screen returns.

- For receiving a return receipt confirmation, select [On] using [▲] or [▼], and then press the [OK] key.

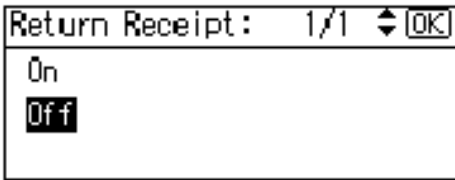

The “Accepted” message appears, and then the Send Options screen returns.

Note

- When [On] is selected, an e-mail notifying that the e-mail has been read by the recipient is sent to the sender selected here. However, if the mailing software used by the recipient does not support MDN (Message Disposition Notification), the e-mail may not be sent.

Searching to select a sender by name

- Press the [Search Destination] key.

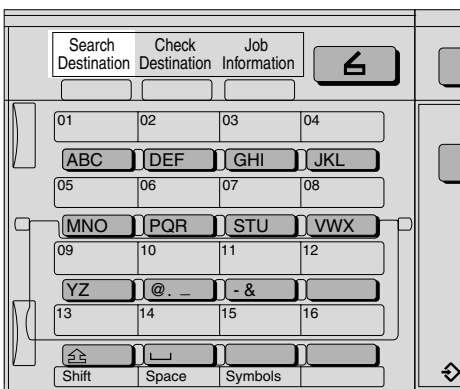

AAH0205

- Select [Search by Name] using [▲] or [▼], and then press the [OK] key.

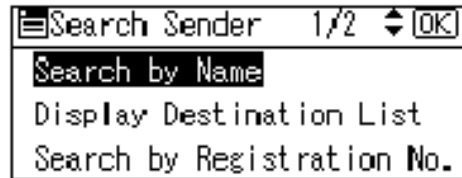

- Enter the beginning of the sender name, and then press the [OK] key twice.

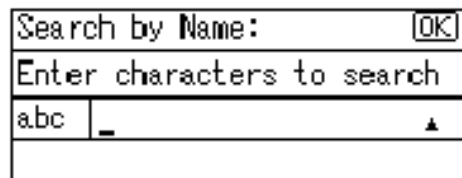

Note

- Enter the first character or characters of the sender name.
- It is necessary to differentiate between uppercase and lowercase.

Reference

For information about how to enter characters, see *General Settings Guide*.

- Select the sender using [▲] or [▼], and then press the [OK] key.

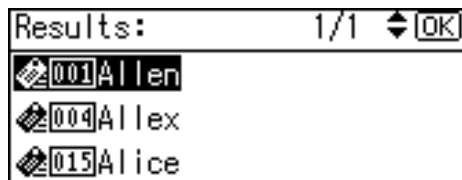

Note

- When a sender's password is set, a screen for entering the sender's password appears. Enter the sender's password using the number keys, and then press the **[OK]** or **[#]** key. If the password entered is correct, the sender name is displayed.

5 Press the [OK] key.



The "Accepted" message appears, and then the Return Receipt screen returns.

6 For receiving a return receipt confirmation, select [On] using [▲] or [▼], and then press the [OK] key.

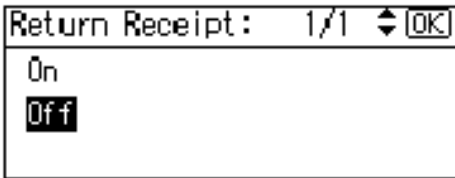

The "Accepted" message appears, and then the Send Options screen returns.

Note

- When **[On]** is selected, an e-mail notifying that the e-mail has been read by the recipient is sent to the sender selected here. However, if the mailing software used by the recipient does not support MDN (Message Disposition Notification), the e-mail may not be sent.

Selecting a sender from Destination List

1 Press the [Search Destination] key.

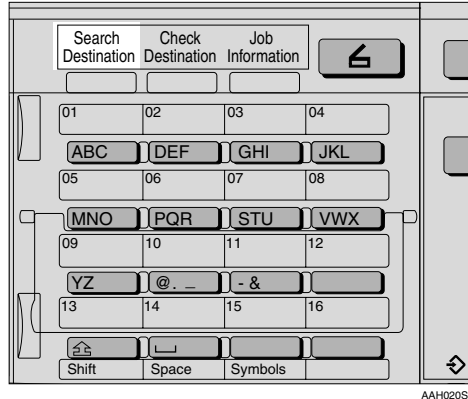

2 Select [Display Destination List] using [▲] or [▼], and then press the [OK] key.

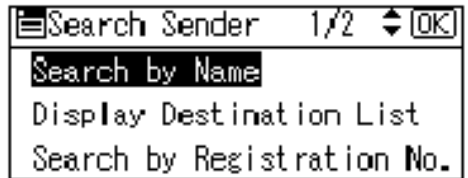

3 Select the sender using [▲] or [▼], and then press the [OK] key.



Note

- When a sender's password is set, a screen for entering the sender's password appears. Enter the sender's password using the number keys, and then press the **[OK]** or **[#]** key. If the password entered is correct, the sender name is displayed.

- ④ Press the **[OK]** key.

Sender's Name:	[OK]
Use Quick Dial/Search Dest.	
[02]Brown	

The "Accepted" message appears, and then the Return Receipt screen returns.

- ⑤ For receiving a return receipt confirmation, select **[On]** using **[▲]** or **[▼]**, and then press the **[OK]** key.

Return Receipt:	1/1	[OK]
On		
Off		

The "Accepted" message appears, and then the Send Options screen returns.

Note

- When **[On]** is selected, an e-mail notifying that the e-mail has been read by the recipient is sent to the sender selected here. However, if the mailing software used by the recipient does not support MDN (Message Disposition Notification), the e-mail may not be sent.

Searching to select a sender using a registration number

- ① Press the **[Search Destination]** key.

Search Destination	Check Destination	Job Information	[←]
01	02	03	04
ABC	DEF	GHI	JKL
05	06	07	08
MNO	PQR	STU	VWX
09	10	11	12
YZ	@, _	- &	
13	14	15	16
Shift	Space	Symbols	[↗]

AAH020S

4

- ② Select **[Search by Registration No.]** using **[▲]** or **[▼]**, and then press the **[OK]** key.

Search Sender	1/2	[OK]
Search by Name		
Display Destination List		
Search by Registration No.		

- ③ Enter a 3-digit registration number that has been assigned to a sender using the number keys, and then press the **[OK]** key twice.

Search by Regist. No.:	[OK]	
Enter No. to search		
<table border="1" style="margin: auto;"> <tr> <td style="width: 30px; height: 20px;"> </td> </tr> </table>		

Note

- When a sender's password is set, a screen for entering the sender's password appears. Enter the sender's password using the number keys, and then press the **[OK]** or **[#]** key. If the password entered is correct, the sender name is displayed.

4 Press the [OK] key.

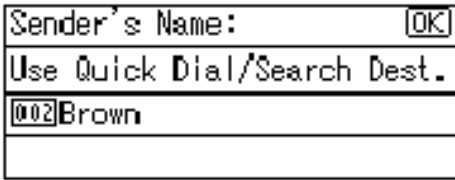

The "Accepted" message appears, and then the Return Receipt screen returns.

5 For receiving a return receipt confirmation, select [On] using [▲] or [▼], and then press the [OK] key.

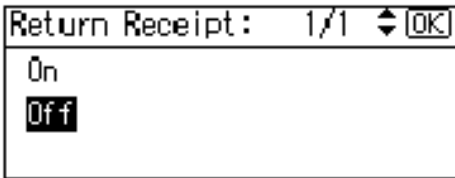

The "Accepted" message appears, and then the Send Options screen returns.

Note

- When **[On]** is selected, an e-mail notifying that the e-mail has been read by the recipient is sent to the sender selected here. However, if the mailing software used by the recipient does not support MDN (Message Disposition Notification), the e-mail may not be sent.

6 Press the [Cancel] key.

Searching to select a sender by e-mail address

1 Press the [Search Destination] key.

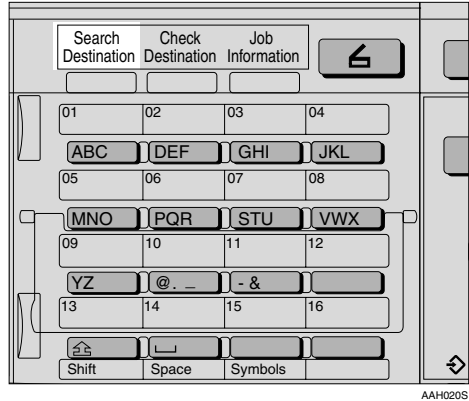

2 Select [Search by E-mail Address] using [▲] or [▼], and then press the [OK] key.

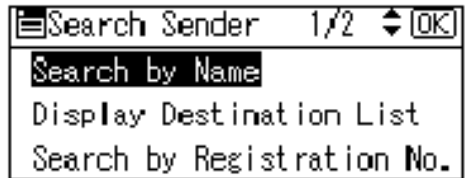

3 Enter the beginning of the sender's e-mail address, and then press the [OK] key twice.

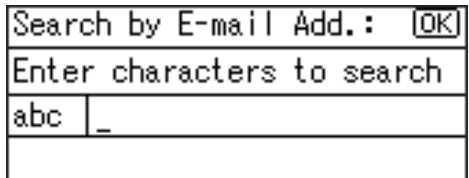

Note

- Enter the first character or characters of the sender name.
- It is necessary to differentiate between uppercase and lowercase.

Reference

For information about how to enter characters, see *General Settings Guide*.

- 4 Select the sender using **[▲]** or **[▼]**, and then press the **[OK]** key.

Results:	1/1	[OK]
[001]Allen		
[004]Alex		
[015]Alice		

Note

- When a sender's password is set, a screen for entering the sender's password appears. Enter the sender's password using the number keys, and then press the **[OK]** or **[#]** key. If the password entered is correct, the sender name is displayed.

- 5 Press the **[OK]** key.

Sender's Name:	[OK]
Use Quick Dial/Search Dest.	
[001]Allen	

The "Accepted" message appears, and then the Return Receipt screen returns.

- 6 For receiving a return receipt confirmation, select **[On]** using **[▲]** or **[▼]**, and then press the **[OK]** key.

Return Receipt:	1/1	[OK]
On		
Off		

The "Accepted" message appears, and then the Send Options screen returns.

Note

- When **[On]** is selected, an e-mail notifying that the e-mail has been read by the recipient is sent to the sender selected here. However, if the mailing software used by the recipient does not support MDN (Message Disposition Notification), the e-mail may not be sent.

- 9 Specify a subject if necessary.

- 1 Press **[Options]**.
- 2 Select **[Attach Subject]** using **[▲]** or **[▼]**, and then press the **[OK]** key.

Send Options	1/3	[OK]
Sender's Name		
Resolution		
Original Orientation		

Note

- When a subject is set, it is added to the scan file. The subject appears automatically in the Subject field of the e-mail.
- To specify a subject, you can select it from the list, enter it directly, or combine selecting and entering it.
- A subject to select from the list must be registered in **[System Settings]** in advance. See *Network Guide*.
- A subject can be entered using up to 64 characters.

Manual entry of a subject

- 1 Select [Manual Input] using [▲] or [▼], and then press the [OK] key.

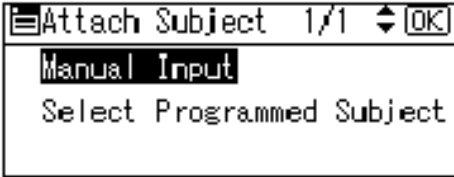

- 2 Enter a subject, and then press the [OK] key.

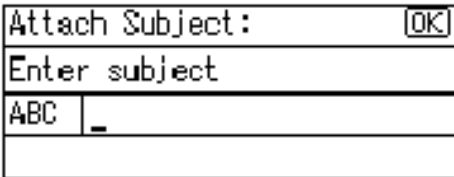

The “Accepted” message appears, and then the Send Options screen returns.

Note

- When the subject to be entered exceeds 64 characters, “▲” appears.

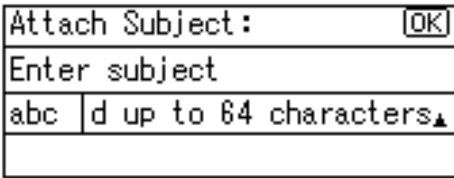

Selecting a subject from the list

- 1 Select [Select Programmed Subject] using [▲] or [▼], and then press the [OK] key.

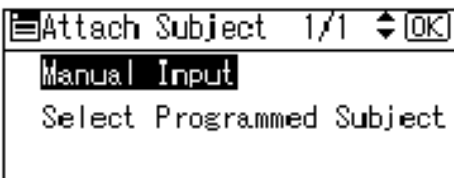

- 2 Select a subject using [▲] or [▼], and then press the [OK] key.

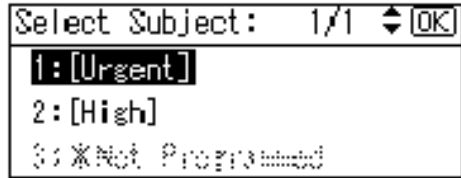

The “Accepted” message appears, and then the Send Options screen returns.

- 10 Press the [Cancel] key.

The initial scanner screen appears.

- 11 Press the [Start] key.

Note

- The original is scanned and the “Scanning...” message appears.



- To interrupt scanning, press the [Clear/Stop] key.

- The scan file is sent and the “Sending...” message appears.

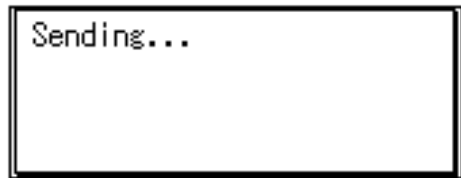

- While sending a scan file, you cannot do any other job.
- If sending fails, start the procedure again from the beginning.

Checking the Status of E-mail

The status of the last 50 sendings can be checked. For every new sending record after 50, the oldest record is deleted.

Important

- ❑ When the main power switch is turned off, all records are deleted.

Note

- ❑ When **[Print&Del. Scanner Journal]** is set to **[On]**, the whole scanner journal is printed when the number of records reaches 50.

◆ Items that can be checked

- **Date/Time**
The date and time the e-mail was sent or the date "Error" was confirmed is displayed.
- **Page**
The number of pages of a scan file is displayed.
- **Status**
One of the following is displayed: "Done" or "Error".
- **Destination**
The function that was used (e-mail or delivery function) is displayed with an icon. When multiple destinations were selected, the first selected destination is displayed.

1 Press the **[Job Information]** key.

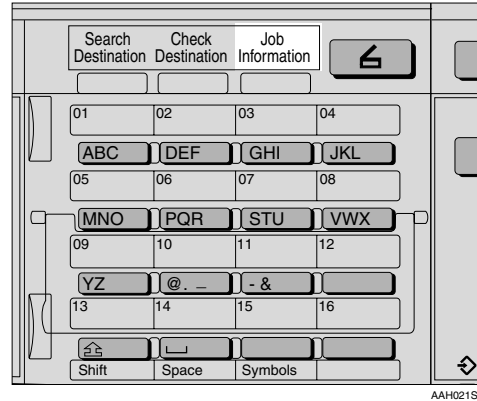

2 Check the displayed records.

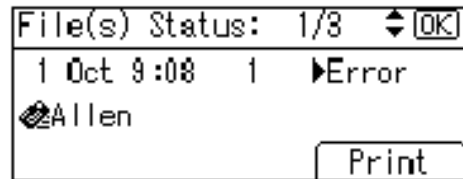

3 If you want to print the scanner journal, press **[Print]**, and then press the **[Start]** key.

Note

- ❑ The whole scanner journal is printed.

4 Press the **[Cancel]** key.

The display returns to the E-mail screen.

5. Using the Network Delivery Scanner Function

Scan files can be sent to a specified destination using the network delivery scanner function. This chapter explains the preparation sequence, various display screens, delivery procedures, and how to check the delivery result when this function is used.

❗ Important

- ❑ A delivery server in which the ScanRouter delivery software is installed is necessary to use the network delivery scanner function. Information about delivery destinations and senders must be registered first into the delivery server. Also, configure connected devices in **[Set I/O Device]** of the ScanRouter delivery software. For more information, see the ScanRouter delivery software Help.

Preparation for Delivering

To use the machine as a network delivery scanner, the preparation described below is required.

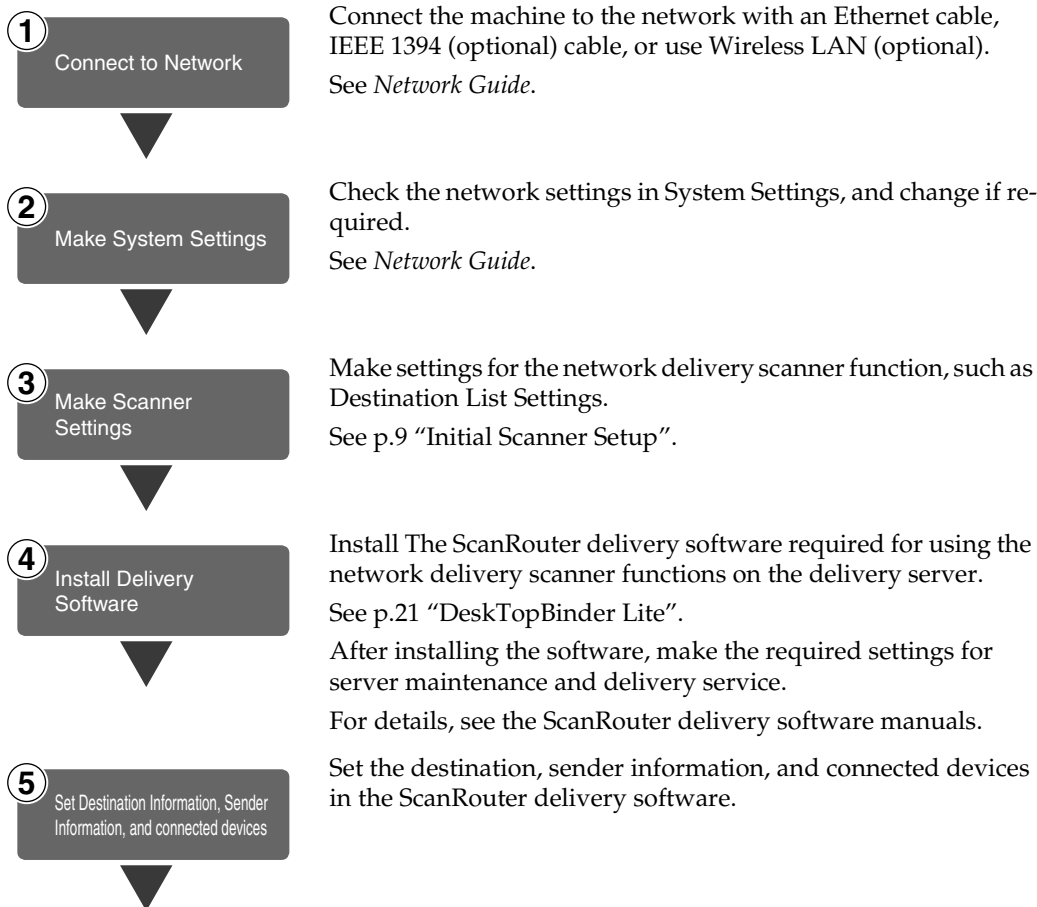

6 Install Client Computer Software

On the client computers, install the application required for viewing or retrieving files by connecting to the delivery server, such as DeskTopBinder Lite.
See p.22 "DeskTopBinder Lite".

Network Delivery Scanner Screen

These screens are shown when using the machine as a network delivery scanner.

◆ Main display

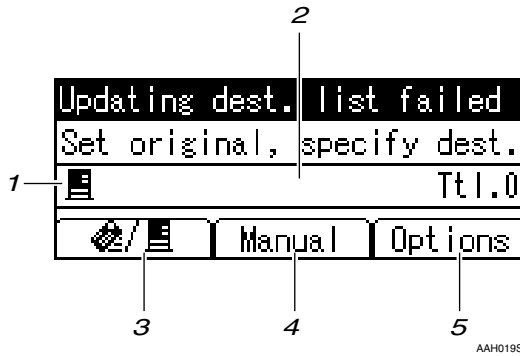

◆ When a destination is selected

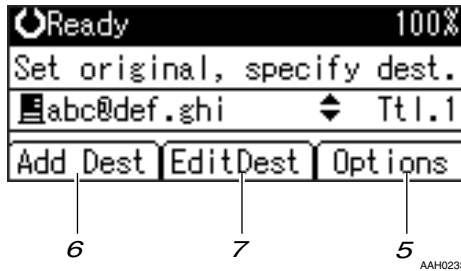

1. Network Delivery Scanner icon (🖨️)

Indicates that the Network Delivery Scanner screen is displayed.

2. Destination field

Displays the selected destination. If multiple destinations are selected, the destinations are displayed in the order they were selected by pressing [▲] or [▼].

Note

- ❑ Press the **[Check Destination]** key to check the selected destination.
- ❑ Group destinations are denoted by this symbol (🖨️).

3. [🖨️/🖨️] E-mail/Network Delivery Scanner

Press to switch between the network delivery scanner function and the e-mail function.

4. [Manual]

When specifying a destination that is not registered, press **[Manual]**, and then enter the e-mail address of the destination using the Quick Dial keys.

5. [Options]

Press to make the scan settings such as resolution or scan size, the sender, and the subject of the e-mail to be sent.

6. [Add Dest]

When selecting multiple destinations after a manual entry of a e-mail address, press **[Add Dest]**, and then enter the e-mail address of the destination.

7. [EditDest]

When changing the e-mail address that has been entered, press **[EditDest]**, and then re-enter the e-mail address.

Delivering Scan Files

Delivery Procedure

Scan files are delivered after scan settings and destinations are specified. If necessary, you can select a sender and a subject.

1 Press the **[Scanner]** key.

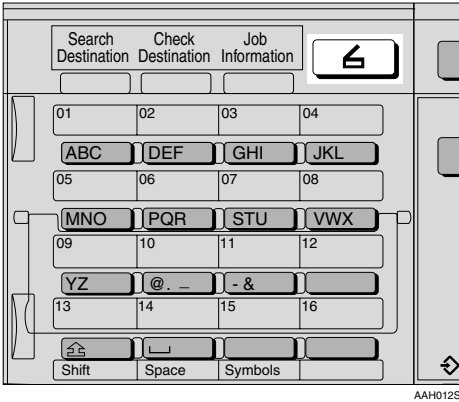

2 If the user codes are set, enter a user code using the number keys, and then press the **[#]** key.

The initial scanner screen appears.

Reference

For information about user codes, see *General Settings Guide*.

3 If the E-mail screen appears, press **[E-mail]** to switch to the Network Delivery Scanner screen.



The Network Delivery Scanner screen appears.

4 Make sure that no previous settings remain.

Note

If a previous setting remains, press the **[Clear Modes]** key.

5 Place the original in the machine, and then make the scan settings and settings for orientation if necessary.

Reference

p.12 "Scan Settings"
p.27 "Setting Originals"

Making the settings

- 1** Press **[Options]**.
- 2** Select items such as resolution and original size using **[▲]** or **[▼]**, and then change their settings.

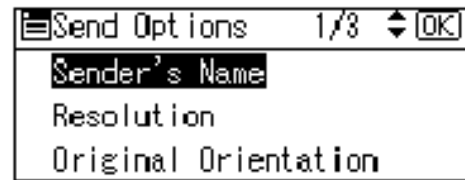

Scan settings can be made in the same way as default scan settings. See p.12 "Scan Settings".

3 Press the **[Cancel]** key.

The Network Delivery Scanner screen appears.

6 Specify the destination.

To specify a destination, you can select it using the Quick Dial key, search for and select it from the Destination List, select it by specifying a registration number, or enter the e-mail address directly.

Note

- When using the ScanRouter delivery software, the Destination List is updated automatically.

Using a Quick Dial key to select a destination

- 1 Press the Quick Dial key in which the destination is registered.

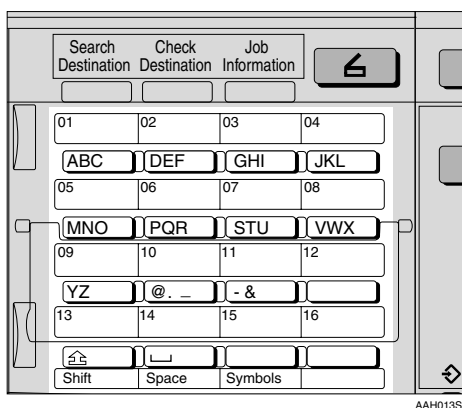
**Reference**

For more information about how to register the destination, see *General Settings Guide*.

- 2 To select more destinations, repeat step 1.

**Note**

- To deselect a destination, press **[▲]** or **[▼]** to display the Destination in the destination field, and then press the **[Clear/Stop]** key.

Searching to select a destination by name

- 1 Press the **[Search Destination]** key.

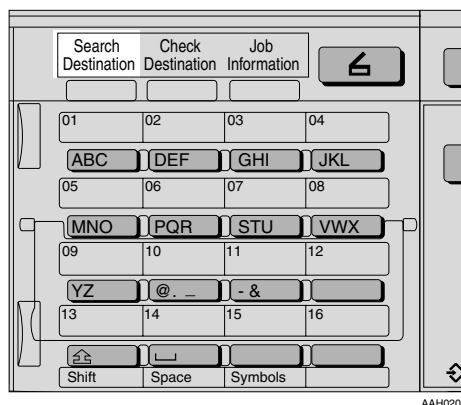

- 2 Select **[Search by Name]** using **[▲]** or **[▼]**, and then press the **[OK]** key.

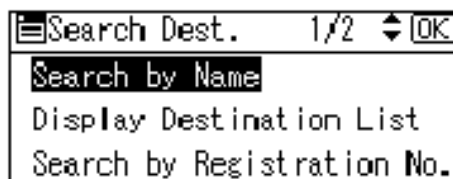

- 3 Enter the beginning of the destination name, and then press the **[OK]** key twice.

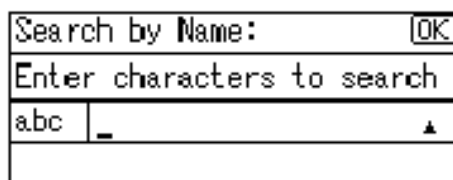
**Note**

- Enter the first character or characters of the destination name.
- It is necessary to differentiate between uppercase and lowercase.

Reference

For information about how to enter characters, see *General Settings Guide*.

- 4 Select the destination using **[▲]** or **[▼]**, and then press the **[OK]** key.

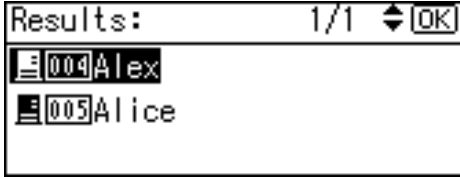

- 5 To select more destinations, repeat steps 1 to 4.

Note

- To deselect a destination, press **[▲]** or **[▼]** to display the destination in the Destination field, and then press the **[Clear/Stop]** key.

- 3 Select the destination using **[▲]** or **[▼]**, and then press the **[OK]** key.

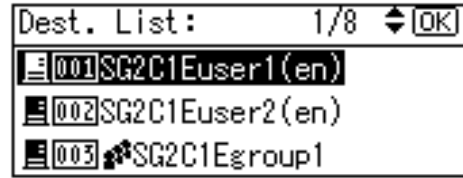

- 4 To select more destinations, repeat steps 1 to 3.

Note

- To deselect a destination, press **[▲]** or **[▼]** to display the destination in the Destination field, and then press the **[Clear/Stop]** key.

5

When selecting a destination from Destination List

- 1 Press the **[Search Destination]** key.

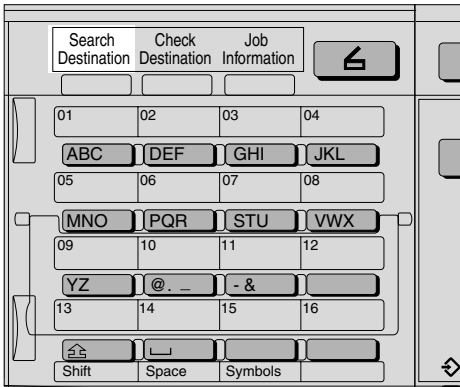

AAH020S

- 2 Select **[Display Destination List]** using **[▲]** or **[▼]**, and then press the **[OK]** key.

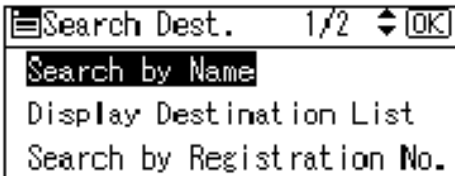

Searching to select a destination by registration number

- 1 Press the **[Search Destination]** key.

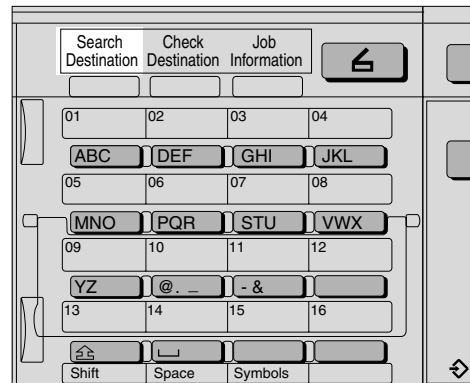

AAH020S

- 2 Select **[Search by Registration No.]** using **[▲]** or **[▼]**, and then press the **[OK]** key.

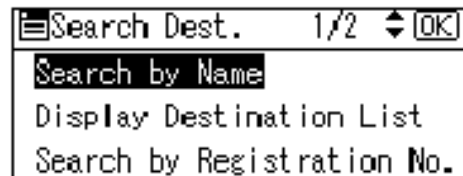

- Enter a 3-digit registration number that has been assigned to a destination using the number keys, and then press the **[OK]** key.

- Press the **[OK]** key.

- To select more destinations, repeat steps 1 to 4.

Note

- To deselect a destination, press **[▲]** or **[▼]** to display the destination in the Destination field, and then press the **[Clear/Stop]** key.

Searching to select a destination by comment

- Press the **[Search Destination]** key.

AAH020S

- Select **[Search by Comment]** using **[▲]** or **[▼]**, and then press the **[OK]** key.

- Enter the beginning of the comment, and then press the **[OK]** key twice.

Note

- Enter the first character or characters of the comment.
- It is necessary to differentiate between uppercase and lowercase.

Reference

For information about how to enter characters, see *General Settings Guide*.

- Select the destination using **[▲]** or **[▼]**, and then press the **[OK]** key.

- To select more destinations, repeat steps 1 to 4.

Note

- To deselect a destination, press **[▲]** or **[▼]** to display the destination in the Destination field, and then press the **[Clear/Stop]** key.

Manual entry of a destination

Note

- When using ScanRouter EX Professional, it is possible to enter the e-mail address of the destination directly. However, settings for sending e-mail must be made in advance.

- 1 Press **[Manual]**.
- 2 Enter the e-mail address.

Note

- It is possible to use letters, number, and periods. The symbols ()\,;:" cannot be used.

Reference

For information about how to enter characters, see *General Settings Guide*.

- 3 Press the **[OK]** key.

Note

- To change an e-mail address that has been entered, press **[EditDest]**. The display returns to the E-mail Address screen. Make any changes, and then press the **[OK]** key.
- If the entered destination is longer than the Destination field, the address will be omitted and **[...]** is displayed instead.

- 4 To enter more destinations, press **[Add Dest]**, and then repeat steps 1 to 3.

Note

- To deselect a destination, press **[▲]** or **[▼]** to display the destination in the Destination field, and then press the **[Clear/Stop]** key.

Checking selected destinations

- 1 Use the Destination field to check which destinations are selected.

Note

- When multiple destinations are selected, the selected destinations are displayed in the order they were selected by pressing **[▲]** or **[▼]**.
- Press the **[Check Destination]** key to check the details of the selected destination.

- 7 Specify the sender (scan file deliver source) if necessary.

To specify a sender, you can search for and select it from the Destination List, or select it by specifying a registration number.

- 1 Press **[Options]**.
- 2 Select **[Sender's Name]** using **[▲]** or **[▼]**, and then press the **[OK]** key.

Note

- When a sender is selected, the sender name is automatically placed in the From field of the e-mail so that the sender can be identified by the recipient.

Using a Quick Dial key to select a sender

- 1 Press the Quick Dial key in which the sender is registered.

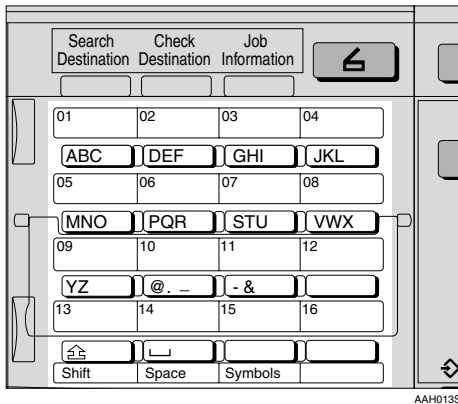
**Reference**

For more information about how to register the destination, see *General Settings Guide*.

- 2 Press the [OK] key.

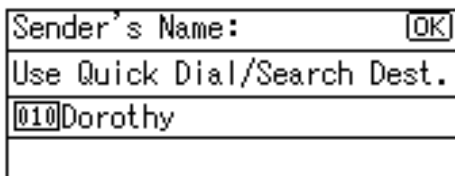

The “Accepted” message appears, and then the Return Receipt screen returns.

- 3 For receiving a return receipt confirmation, select [On] using [▲] or [▼], and then press the [OK] key.

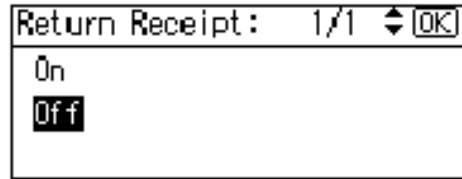

The “Accepted” message appears, and then the Send Options screen returns.

Note

- When [On] is selected, an e-mail notifying that the e-mail has been read by the recipient is sent to the sender selected here. However, if the mailing software used by the recipient does not support MDN (Message Disposition Notification), the e-mail may not be sent.

Searching to select a sender by name

- 1 Press the [Search Destination] key.
- 2 Select [Search by Name] using [▲] or [▼], and then press the [OK] key.

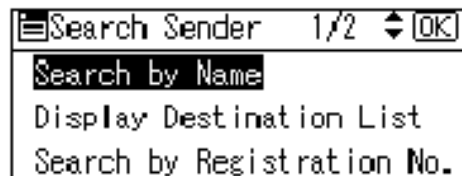

- 3 Enter the beginning of the sender name, and then press the [OK] key twice.

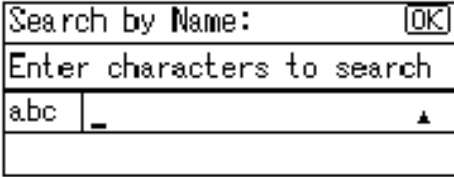

Note

- Enter the first character or characters of the sender name.
- It is necessary to differentiate between uppercase and lowercase.

Reference

For information about how to enter characters, see *General Settings Guide*.

- 4 Select the sender using [▲] or [▼], and then press the [OK] key.

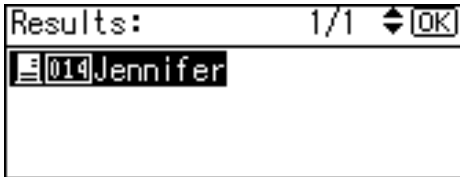

- 5 Press the [OK] key.

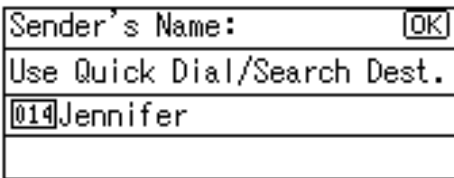

The “Accepted” message appears, and then the Return Receipt screen returns.

- 6 For receiving a return receipt confirmation, select [On] using [▲] or [▼], and then press the [OK] key.

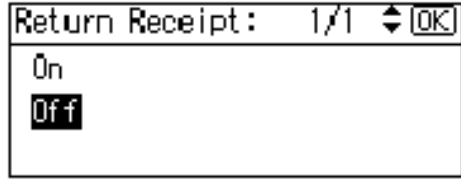

The “Accepted” message appears, and then the Send Options screen returns.

Note

- When [On] is selected, an e-mail notifying that the e-mail has been read by the recipient is sent to the sender selected here. However, if the mailing software used by the recipient does not support MDN (Message Disposition Notification), the e-mail may not be sent.

When selecting a sender from Destination List

- 1 Press [Search Destination].

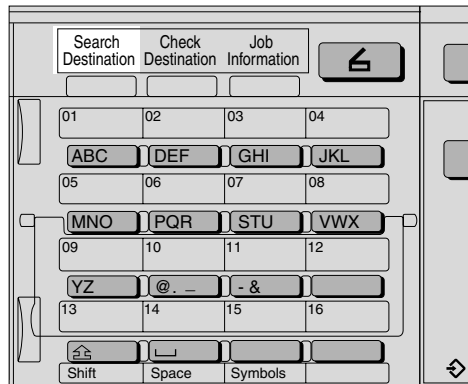

AAH0205

- ② Select [Display Destination List] using [▲] or [▼], and then press the [OK] key.

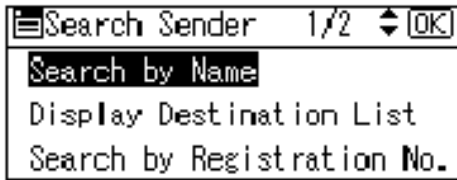

- ③ Select the sender using [▲] or [▼], and then press the [OK] key.

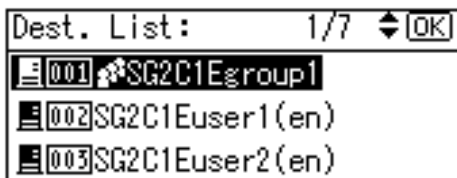

- ④ Press the [OK] key.

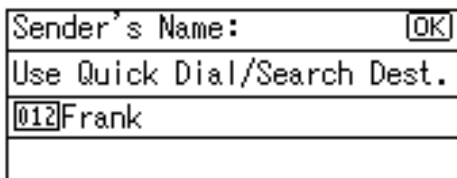

The "Accepted" message appears, and then the Return Receipt screen returns.

- ⑤ For receiving a return receipt conformation, select [On] using [▲] or [▼], and then press the [OK] key.

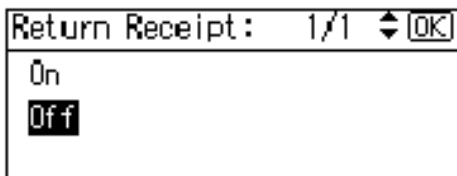

The "Accepted" message appears, and then the Send Options screen returns.

Note

- When [On] is selected, an e-mail notifying that the e-mail has been read by the recipient is sent to the sender selected here. However, if the mailing software used by the recipient does not support MDN (Message Disposition Notification), the e-mail may not be sent.

Searching to select a sender by registration number

- ① Press the [Search Destination] key.

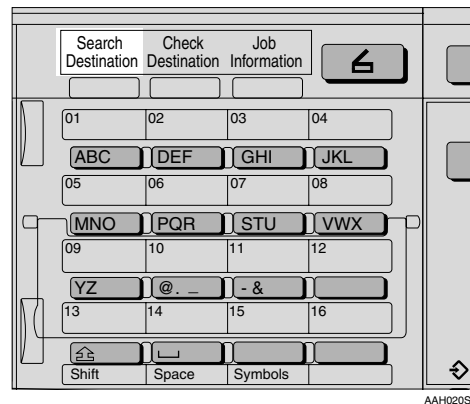

- ② Select [Search by Registration No.] using [▲] or [▼], and then press the [OK] key.

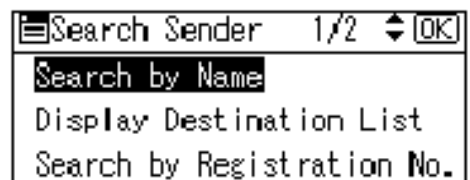

- 3 Enter a 3-digit registration number that has been assigned to a sender using the number keys, and then press the [OK] key twice.



- 4 Press the [OK] key.

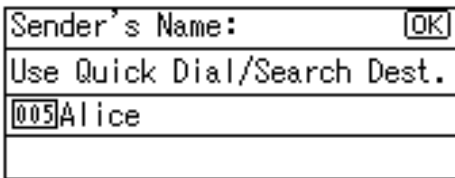

The "Accepted" message appears, and then the Return Receipt screen returns.

- 5 For receiving a return receipt conformation, select [On] using [▲] or [▼], and then press the [OK] key.

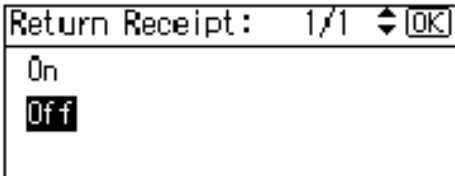

The "Accepted" message appears, and then the Send Options screen returns.

Note

- When [On] is selected, an e-mail notifying that the e-mail has been read by the recipient is sent to the sender selected here. However, if the mailing software used by the recipient does not support MDN (Message Disposition Notification), the e-mail may not be sent.

- 8 Specify a subject if necessary.

- 1 Press [Options].
- 2 Select [Attach Subject] using [▲] or [▼], and then press the [OK] key.

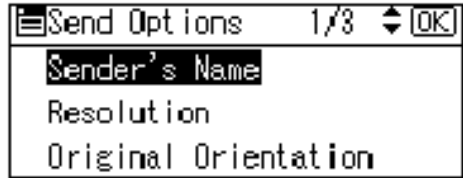

Note

- When a subject has been set, this information is added to the scan file.
- When ScanRouter EX Professional is used to send files using e-mail, the subject is automatically placed in the Subject field of the e-mail.
- To specify a subject, you can select it from the list, enter it directly, or combine selecting and entering it.
- A subject to select from the list must be registered in [System Settings] in advance. See *Network Guide*.
- A subject can be entered using up to 64 characters.

Manual entry of a subject

- 1 Select [Manual Input] using [▲] or [▼], and then press the [OK] key.

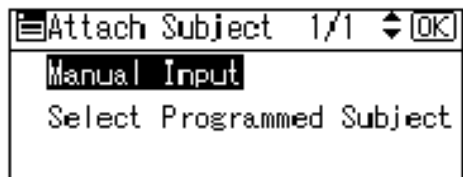

- ② Enter a subject, and then press the **[OK]** key.

The “Accepted” message appears, and then the Send Options screen returns.

Attach Subject:	[OK]
Enter subject	
ABC	_

 **Note**

- When the subject to be entered exceeds 64 characters, “▲” appears.

Attach Subject:	[OK]
Enter subject	
abc	d up to 64 characters▲

When selecting a subject from the list

- ① Select **[Select Programmed Subject]** using **[▲]** or **[▼]**, and then press the **[OK]** key.

Attach Subject	1/1	[OK]
Manual Input		
Select Programmed Subject		

- ② Select a subject using **[▲]** or **[▼]**, and then press the **[OK]** key.

Select Subject:	1/1	[OK]
1: [Urgent]		
2: [High]		
3: *Not Programmed		

The “Accepted” message appears, and then the Send Options screen returns.

- ⑨ Press the **[Cancel]** key.

The initial scanner screen appears.

- ⑩ Press the **[Start]** key.

 **Note**

- The original is scanned and the “Scanning...” message appears.

Scanning...	100%	
Original:	1	
[023]Sowa	Ttl.1	
Add (next)	Manual	Options

- To interrupt scanning, press the **[Clear/Stop]** key.
- The scan file is sent and the “Sending...” message appears.

Sending...

- While sending a scan file, you cannot do any other job.
- If sending fails, start the all procedure again from the beginning.

Checking the Status of Delivery

The status of the last 50 deliveries can be checked. For every new delivery record after 50, the oldest record is deleted.

Important

- When the main power switch is turned off, all records are deleted.

Note

- When **[Print&Del. Scanner Journal]** is set to **[On]**, the whole journal is printed when the number of records reaches 50.

5

Items that can be checked

- **Date/Time**
The date and time the delivery was requested or the date "Error" was confirmed is displayed.
- **Page**
The number of pages of a scan file is displayed.
- **Status**
One of the following is displayed: "Done" or "Error".
- **Destination**
The function that was used (e-mail, or delivery function) is displayed with an icon.
When multiple destinations were selected, the first selected destination is displayed.

1 Press the **[Job Information]** key.

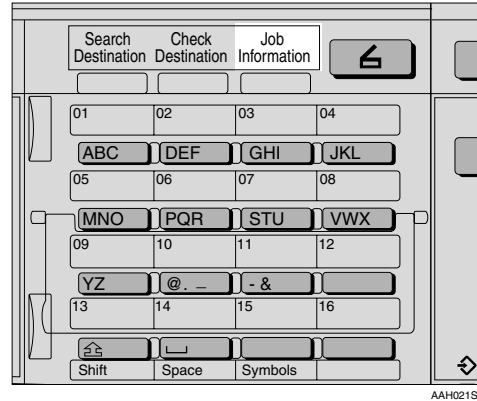

2 Check the displayed records.



3 If you want to print the scanner journal, press **[Print]**, and then press the **[Start]** key.

Note

- The whole scanner journal is printed.

4 Press the **[Cancel]** key.

The display returns to the E-mail screen.

6. Using the Network TWAIN Scanner Function

This chapter describes the operations for scanning originals with the network TWAIN scanner using DeskTopBinder Lite. In addition, the preparation for using the network TWAIN scanner and some functions of the TWAIN driver are introduced.

Preparation for Using the Network TWAIN Scanner

To use the machine as a network TWAIN scanner, the preparation described below is required.

- 

1 Connect to Network

Connect the machine to the network with an Ethernet cable, IEEE 1394 (optional) cable, or use Wireless LAN (optional).
See *Network Guide*.
- 

2 Make System Settings

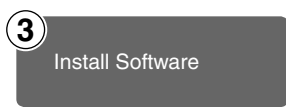
Check the network settings in System Settings, and change if required.
See *Network Guide*.
- 

3 Install Software

On the client computers, install the software required for using the network TWAIN scanner functions, such as a TWAIN driver and DeskTopBinder Lite.
See p.19 “Software for Using a Network TWAIN Scanner”.

Network TWAIN Scanner Screen

When using the machine as a network TWAIN scanner, it is not necessary to press the **[Scanner]** key on the control panel. When the TWAIN driver becomes active on a client computer, the display automatically switches to the following screen.

Press **[Exit]** to use functions other than the network TWAIN scanner function.

Scanning Originals

This section explains how to scan originals using the network TWAIN scanner function.

1 Start **DeskTopBinder Lite**, and then select the scanner driver.

1 On the **[Start]** menu, point to **[Program]**, point to **[DeskTopBinder]**, and then click **[DeskTopBinder]**.

2 Click **[Scanner Settings]** on the **[Tools]** menu.

If the scanner is already selected, no scanner settings are necessary. Check the settings in the **[File format for scanned image(s)]** area, and then proceed to step

5.

3 Click **[Select Scanner Driver...]**.

4 Select the name of the machine you want to use in the list, and then click **[Select...]**.

5 Click **[OK]**.

2 Place the original in the scanner.

 **Reference**

p.27 "Setting Originals"

3 Make the scan settings.

1 On the **[File]** menu, point to **[Add Document]**, and then click **[Scan]**.

The TWAIN driver starts.

After a short while, the dialog box of the TWAIN driver that operates the scanner appears. This dialog box is called the Scanner Properties dialog box.

Note

The name of the scanner currently being used is shown on the title bar of the dialog box. When multiple machines are connected, make sure that the indicated machine is the machine you want to use. If it is different, click **[Select Scanner]** to select the scanner again.

If the machine you want to use is not displayed in the list, make sure that the IP address is configured and that the machine is correctly connected to the network. If the machine is still not displayed in the list after confirming the above, consult with your network administrator.

2 Depending on the type of original or the objective for scanning, click the appropriate button in **[Mode]**.

- **[Standard]** is suitable for scanning standard originals that are comprised of mainly text.

- **[Photo]** is suitable for scanning originals that include photos, shaded illustrations, etc.

- **[OCR]** is suitable for conversion processing with an OCR (Optical Character Reading) application after scanning the original.

- **[Filing]** is suitable for use with filing applications, etc.

 **Note**

- For advanced settings, click **[Detail]** to display the Detail window. For information about the Detail window, see TWAIN driver Help.

- 3** According to the settings of **[Document]** and **[Orientation:]**, change the other setting of the **[Document]** group.

 **Reference**

p.33 "For a Network TWAIN Scanner"

For information about making settings for the **[Document]** group, see TWAIN driver Help.

When you want to configure the scanning area

When you do not configure the scanning area, the area scanned is the size specified in the **[Size:]** box.

- 1** Click **[Preview]**.

The original that was placed is scanned and the **[Preview]** dialog box appears. The scanning area in the preview is displayed within the broken lines.

 **Note**

- When you change the scan settings after previewing the original, scan that original again.

- 2** Configure the scanning area by dragging a border or a corner.

When reconfiguring the area, click  and drag one corner of the area towards or away from its opposite corner.

 **Note**

- Depending on the scanning resolution, the area to be scanned may be subject to restrictions.

- 3** Click **[Close]**.

 **Note**

- When an original placed in the ADF is previewed, place that original again.

- 4** Click **[Scan]**.

When there are additional originals to scan, place the original, and then click **[Continue]**. When there are no more originals, click **[Complete]**.

- 5** Save the scan file in DeskTop-Binder Lite.

- 1** On the **[File]** menu, click **[Exit]**.

- 2** Enter the file name, and then click **[OK]**.

The scan file is stored in DeskTopBinder Lite, and DeskTopBinder Viewer closes.

 **Editing and printing scan files**

With DeskTopBinder Lite, it is possible to edit and print scan files. For more information about how to edit and print, see DeskTopBinder Lite Help.

Functions of the TWAIN Driver

The following is an introduction to the various functions of the TWAIN driver:

❖ Automatic Tilt Correction

This function automatically corrects character strings that were scanned slanted.

❖ Printing to the Image

This function allows you to imprint dates, page numbers, or your favorite characters on a scan file. You can also change the fonts of the imprints as well as change the ascending order of images to a descending order.

❖ Scanning Mode Registration

This function allows you to register other scanning configurations that are often used as scanning modes besides the already pre-installed ones. After registration, you can quickly scan with these scanning configurations.

Reference

For more information about these functions or other functions, see TWAIN driver Help.

Relationship between Resolution and File Size

Resolution and scan area are inversely related. The higher the resolution is set, the smaller the area that can be scanned. Conversely, the larger the scan area, the lower the resolution that can be set.

The relationship between the scanning resolution and the file size is shown below. If the file size is too large, the message “Exceeded max.data capacity. Check the scanning resolution.” appears on the control panel of the machine. Specify the scan size and resolution again.

Limitation

- Depending on the image compression level, the maximum image size will be limited.

When Using as E-mail or Network Delivery Scanner

All combinations up to 297 × 432 mm/11.6 × 17.0 inches (A3, 11 × 17 inches) and 600 dpi are possible.

When Using as a Network TWAIN Scanner

All combinations up to 297 × 432 mm/11.6 × 17.0 inches (A3, 11 × 17 inches) and 600 dpi are possible.

Reference

To specify the scanning area or resolution when using the machine as a network TWAIN scanner, see TWAIN driver Help.

Note

- When the originals cannot be scanned, select **[No compression]** in Select Device Data Compression.

Max. Number of Addresses Which Can Be Specified

	E-mail	Delivery Server
The number of addresses which can be specified at a time when sending	100 *1	100 *2
The number of addresses which can be registered in the list	150	See the manuals for the ScanRouter Delivery software
The max. number of files which can be scanned	1	
The max. number of pages which can be scanned	100	
The max. number of pages which can be scanned as a single file	100	

*1 Up to 50 addresses can be entered directly. All remaining addresses have to be specified using the registered ones.

*2 The maximum number of addresses which can be specified varies depending on the software you use, ScanRouter V2 Lite or ScanRouter EX Professional. For more information, see the manuals for the ScanRouter Delivery software.

 **Note**

- Sometimes the machine cannot scan files to the maximum number depending on the type of originals.
- When the power switch is turned off, all records are deleted.

Troubleshooting

This section contains advice on what to do if you have problems scanning an original, or if the network delivery scanner or e-mail function does not work. Various messages that may appear on the control panel or client computer are listed, along with causes and solutions.

When Scanning Is Not Performed as Expected

Problems	Causes and solutions
No image results from scanning.	The original was placed with the front and back reversed. When the original is placed directly on the exposure glass, the side to be scanned must face down. When the original is fed via the ADF, the side to be scanned must face up. See p.27 "Setting Originals".
The image is distorted or out of position.	<ul style="list-style-type: none"> • The original was moved during scanning. Do not move the original during scanning. • The original was not pressed flat against the exposure glass. Make sure that the original is pressed flat against the exposure glass.
The scanned image is dirty.	The exposure glass or the exposure glass cover is dirty. Clean these parts. See <i>General Settings Guide</i> .
The scanned image is upside down.	The original was placed upside down. Place the original in the correct orientation. See p.27 "Setting Originals".

7



When the Delivery Function Does Not Work

Problems	Causes and solutions
The delivery scanner function screen is not displayed.	<ul style="list-style-type: none"> • If the network TWAIN scanner screen appears when the machine is switched to scanner mode, press [Exit] to switch to the network delivery scanner screen. • If the display does not switch from network TWAIN scanner to network delivery scanner, the delivery scanner settings are not correct. See p.9 "Scanner Features", and then make the appropriate settings.

When an Error Message Appears on the Control Panel

Note

- If an error message that is not included in this section appears, turn off the main power switch of the machine, and then turn it on again. If the message still appears, note the content of the message and the error number (if listed in the table), and contact your service representative. For information about how to turn off the main power switch, see *General Settings Guide*.

Message	Causes and solutions
Cannot detect original size Select scan size	<ul style="list-style-type: none"> Place the original correctly. Specify the scan size. When placing an original directly on the exposure glass, the lifting/lowering action of the ADF triggers the automatic original size detection process. Lift the ADF by more than 30 degrees.
Cannot enter manually more than nnn destinations.  Note <input type="checkbox"/> "nnn" in the message represents a changeable number.	When there are nnn or more destinations for a delivery or an e-mail, split the destinations into two or more groups.
Cannot specify more than 100 destinations.	When there are 100 or more destinations for a delivery or an e-mail, split the destinations into two or more groups.
Exceeded max. data capacity Check resolution and Start	Specify the scan size and resolution again. Note that it may not be possible to scan very large originals at a high resolution. See p.69 "Relationship between Resolution and File Size".
Exceeded max. data capacity Check the resolution and reset nnn original(s)  Note <input type="checkbox"/> This message appears when using the ADF. <input type="checkbox"/> "nnn" in the message represents a changeable number.	Specify the scan size and resolution again. Note that it may not be possible to scan very large originals at a high resolution. See p.69 "Relationship between Resolution and File Size".
Exceeded max. E-mail size. Sending E-mail has been cancelled.	<ul style="list-style-type: none"> Increase the size of [Max. E-mail Size]. Set [Divide & Send E-mail] to [On (per page)] or [On (per max. size)].

Message	Causes and solutions
Exceeded max. page capacity. Do you want to send the scanned data? Scanned data will be cleared when selecting [No].	Because the number of pages has reached the maximum number that can be sent, the data up to this point is sent. Scan the remaining pages after transmission.
Exceeded max.memory capa. Scanning will be cancelled. Scanned data will be cleared.	Because of insufficient memory space, the first page could not be scanned. Try one of the following measures: <ul style="list-style-type: none"> • Wait for a while, and then retry the scan operation. • Reduce the scan area or scanning resolution.
Exceeded max. memory capacity. Do you want to send the scanned data? Scanned data will be cleared when selecting [No].	Because there is not enough free memory space in the machine for delivery or e-mail, only some of the pages could be scanned. Specify whether or not to deliver the data.
No valid dest. lists. Check the settings or the server status.	Check that the delivery server is on and the authentic settings for the delivery server are correct.
Original is being scanned by another function.	The machine is using another function such as copying. Retry scanning after the operation with the other function is completed.
Sending has failed. Press Job Information key to check the status.	While a file was being sent, a network error occurred and the file could not be sent correctly. Try the operation once more. If the message is still shown, the network may be crowded. Consult the network administrator. Use the Job Information screen to check for the file where the problem occurred. See p.49 "Checking the Status of E-mail" or p.64 "Checking the Status of Delivery". If there is not enough free hard disk space in the destination server, free the necessary hard disk space.
Destination list has been updated. Selected destinations/sender will be cleared.	A specified destination or sender's name was cleared when the destination list in the delivery server was updated. Specify the destination or sender's name again.
E-mail address entered is incorrect. Please re-enter.	Make sure the e-mail address is correct, and then enter it again.

Message	Causes and solutions
Specified group contains some invalid dest. Do you want to select only valid dest.?	The group contains members whose e-mail addresses are not registered. Please check the e-mail addresses of the group and make selections again.
Updating destination list. Reselect destination(s) or sender's name later.	If a destination or a sender's name was already selected, re-select it after this message disappears.
Updating destination list has failed. Try again?	Check whether the server is connected.

When an Error Message Appears on the Client Computer

This section describes the main possible causes and actions for error messages displayed on the client computer when the TWAIN driver is used.

Note

















- If an error message that is not contained in this section appears, turn off the main power switch of the machine, and then turn it on again. If the message is still shown after scanning is performed again, note the content of the message and the error number (if listed in the table), and contact your service representative. For information about how to turn off the main power switch, see *General Settings Guide*.

Message	Causes and solutions
[Cannot add any more scanning mode.]	The maximum number of modes that can be stored is 99. Delete unneeded modes.
[Cannot connect to the scanner. Check the network Access Mask settings in User Tools.]	The access mask is set. Consult the network or scanner administrator.
[Cannot detect the paper size of the original. Specify the scanning size.]	<ul style="list-style-type: none"> • Place the original correctly. • Specify the scan size. • When placing an original directly on the exposure glass, the lifting/lowering action of the ADF triggers the automatic original size detection process. Lift the ADF by more than 30 degrees.
[Cannot find the scanner. Check if the scanner main power is on.]	<ul style="list-style-type: none"> • Check whether the main power switch of the machine is turned off. • Check whether the machine is connected to the network correctly. • Deselect the personal firewall function of the client computers.
[Cannot specify any more scanning area.]	The maximum number of scanning areas that can be stored is 99. Delete unneeded scanning areas.

Message	Causes and solutions
[Clear Misfeed(s) in ADF.]	Remove the jammed originals. When originals are misfed, place them again. Check whether the originals are suitable to be scanned by the machine.
[Communication error has occurred on the network.]	Check whether the client computer can use the TCP/IP protocol.
[Error has occurred in the scanner.]	Check whether the scanning settings made with the application exceed the setting range of the machine.
[Error has occurred in the scanner driver.]	<ul style="list-style-type: none"> • Check whether the network cable is connected correctly to the client computer. • Check whether the Ethernet board of the client computer is recognized correctly by Windows. • Check whether the client computer can use the TCP/IP protocol.
[Fatal error has occurred in the scanner.]	An unrecoverable error has occurred in the machine. Call your service representative.
[Insufficient memory. Close all other applications, then restart scanning.]	Close all the unnecessary applications running on the client computer.
[Insufficient memory. Reduce the scanning area.]	<ul style="list-style-type: none"> • Reset the scan size. • Lower the resolution. • Set with no compression. See p.14 "Send Settings". <p> Note</p> <p><input type="checkbox"/> When a paper misfeed occurs in the machine during printing, scanning cannot be performed. In this case, after the misfed paper has been removed, proceed with scanning.</p>
[Invalid Winsock version. Please use version 1.1 or higher.]	Reinstall the operating system of the computer or copy Winsock from the operating system CD-ROM.
[No response from the scanner.]	<ul style="list-style-type: none"> • Check whether the machine is connected to the network correctly. • The network is crowded. Wait for a while, and then try to reconnect.
[No User Code is registered. Consult your system administrator.]	Access is restricted with user codes. Consult the system administrator of the machine.
[Please call your service representative.]	An unrecoverable error has occurred in the machine. Call your service representative.

Message	Causes and solutions
[Scanner is in use for other function. Please wait.]	A function of the machine other than the scanner function is being used such as the copier function. Wait for a while and reconnect.
[Scanner is not available. Check the scanner connection status.]	<ul style="list-style-type: none">• Check whether the main power switch of the machine is turned off.• Check whether the machine is connected to the network correctly.• Deselect the personal firewall function of the client computers.
[Scanner is not ready. Check the scanner and the options.]	Check whether the ADF cover is closed.
[The name is already in use. Check the registered names.]	You tried to register a name that is already in use. Use another name.

Specifications

Scan method	Flatbed scanning
Scan speed *1	<ul style="list-style-type: none"> E-mail/Network Delivery Scanner Approx.43 pages/minute [Scan size:A4 , Original type: Text(Print), Resolution: 200dpi, Compression: On (MH), Document feeder: ADF, ITU-T No.1 Chart] TWAIN Scanner Approx.25 pages/minute [Scan size:A4 , Colors/Gradients:Binary, Resolution: 200dpi, Select device data compression (Binary/Halftone): Data compression (MMR), Document feeder: ADF, ITU-T No.1 Chart]
Maximum power consumption	Less than 1280 W
Image sensor type	CCD Image Sensor
Scan types	Sheet, book
Interface	Ethernet interface (10BASE-T or 100BASE-TX), IEEE 1394 (IP over 1394) [optional], and IEEE 802.11b (Wireless LAN) [optional]
Maximum scan size	297 × 432 mm/11.6 × 17.0 inches(A3, 11 × 17 inches)
Scan sizes that can be detected automatically	<ul style="list-style-type: none"> Exposure glass A3 , B4 , A4  , B5 , 8" × 13"  ADF A3 , B4 , A4  , B5  , A5  , 8.5" × 13" 
Resolution	600 dpi
Variable range of scan resolution	<ul style="list-style-type: none"> E-mail/Network Delivery Scanner Setting range: 100 dpi, 200 dpi, 300 dpi, 400 dpi, and 600 dpi TWAIN Scanner Setting range: 100 dpi - 600 dpi
File formats that can be sent by e-mail	TIFF, PDF
Compression method	Binary: TIFF (MH, MR, MMR)
Protocol	Network: TCP/IP Sending e-mail:SMTP

*1 Scanning speeds vary according to machine operating conditions, computer (specification, network traffic, and software, etc.), and original types.

INDEX

A

- Automatic Tilt Correction, 68
- Auto run program, 17

C

- Checking the status of delivery, 64
- Checking the Status of E-mail, 49
- Compression, 14
- Control Panel, 6

D

- Default Scan Settings, 12
- Delivering Scan Files, 54
- Delivery Procedure, 54
 - Checking selected destinations*, 58
 - Manual entry of a destination*, 58
 - Manual entry of a subject*, 62
 - Searching to select a destination by comment*, 57
 - Searching to select a destination by name*, 55
 - Searching to select a destination by registration number*, 56
 - Searching to select a sender by name*, 59
 - Searching to select a sender by registration number*, 61
 - Using a Quick Dial key to select a destination*, 55
 - Using a Quick Dial key to select a sender*, 59
 - When selecting a destination from Destination List*, 56
 - When selecting a sender from Destination List*, 60
 - When selecting a subject from the list*, 63
- DeskTopBinder Lite, 21, 22, 65
- Destination List Priority, 14
- Destination List Settings, 10, 14
- Divide&Send Mail, 15

E

- E-mail, 35
- E-mail Informatn. Language, 15
- E-mail Screen, 36

F

- File Type Priority, 14
- Functions of the TWAIN Driver, 68

I

- Initial scanner setup, 9
- Installing software, 17

M

- Max. E-mail Size, 15
- Max. Number of Addresses Which Can Be Specified and Files Which Can Be Stored, 70
- Mixed Orig. Sizes Priority, 12
- Mode, 66

N

- Network delivery scanner, 51
- Network Delivery Scanner Screen, 52
- Network TWAIN scanner, 65

O

- Original orientation and scan area, 31
 - For a Network TWAIN Scanner*, 33
 - For E-mail and a Network Delivery Scanner*, 31
- Original Setting, 12
- Original Type Setting, 13
- Orig. Orientation Priority, 13
- Outline, 3
 - E-mail*, 3
 - Network delivery scanner*, 4
 - Network TWAIN scanner*, 5

P

- Placing Originals, 27
 - Placing on the exposure glass*, 28
 - Placing original in the Auto Document Feeder (ADF)*, 29
- Preparation for Delivering, 51
- Preparation for Sending by E-mail, 35
- Preview, 67
- Print & Del. Scanner Journal, 14
- Printing to the image, 68
- Procedure for Sending by E-mail, 37
 - Checking selected destinations*, 41
 - Manual entry of an e-mail address*, 41
 - Manual entry of a subject*, 48
 - Searching to select a destination by e-mail address*, 40
 - Searching to select a destination by name*, 38
 - Searching to select a destination by registration number*, 39
 - Searching to select a sender by e-mail address*, 46
 - Searching to select a sender by name*, 43
 - Searching to select a sender using a registration number*, 45
 - Selecting a destination from Destination List*, 39
 - Selecting a sender from Destination List*, 44
 - Selecting a subject from the list*, 48
 - Using a Quick Dial key to select a destination*, 38
 - Using a Quick Dial key to select a sender*, 42

R

- Reading the Display and Using Keys, 8
- Relationship between resolution and file size, 69
 - When Using as a Network TWAIN Scanner*, 69
 - When Using as E-mail or Network Delivery Scanner*, 69
- Resolution, 12

S

- Save, 67
- Scanner Features, 9
 - Setting procedure*, 10
- Scanning mode registration, 68
- Scanning originals, 66
- Scanning Originals in Several Times using the Exposure Glass, 34
- ScanRouter V2 Lite, 24
- Scan Settings, 9, 12
- Scan size, 12
- Selecting a custom size, 13
- Sender's Name Default, 15
- Sending Scan Files by E-mail, 37
- Send Settings, 10, 14
- Setting Originals, 27
- SMTP server, 3
- Software for Using the Network Delivery Scanner Function, 20
- Software supplied on CD-ROM, 21
- Specifications, 77

T

- Troubleshooting, 71
 - When an Error Message Appears on the Client Computer*, 74
 - When an Error Message Appears on the Control Panel*, 72
 - When Scanning Is Not Performed as Expected*, 71
 - When the Delivery Function Does Not Work*, 71
- TWAIN Standby Time, 14
- Type2018 TWAIN Driver, 21

U

- Update server dest. list, 14

In accordance with IEC 60417, this machine uses the following symbols for the main power switch:

I means **POWER ON.**

⏻ means **STAND BY.**



Declaration of Conformity

“The Product complies with the requirements of the EMC Directive 89/336/EEC and its amending directives and the Low Voltage Directive 73/23/EEC and its amending directives.”

Trademarks

Adobe, PostScript, and Acrobat are trademarks of Adobe Systems Incorporated.

Ethernet is a registered trademark of Xerox Corporation.

Pentium is a registered trademark of Intel Corporation.

MS, Microsoft, and Windows are registered trademarks of Microsoft Corporation.

Other product names used herein are for identification purposes only and might be trademarks of their respective companies. We disclaim any and all rights in those marks.

- The product name of Windows® 95 is Microsoft® Windows® 95.
- The product name of Windows® 98 is Microsoft® Windows® 98.
- The product name of Windows® Me is Microsoft® Windows® Millennium Edition (Windows Me).
- The product names of Windows® 2000 are as follows:
Microsoft® Windows® 2000 Professional
Microsoft® Windows® 2000 Server
Microsoft® Windows® 2000 Advanced Server
- The product names of Windows® XP are as follows:
Microsoft® Windows® XP Home Edition
Microsoft® Windows® XP Professional
- The product names of Windows Server™ 2003 are as follows:
Microsoft® Windows Server™ 2003 Standard Edition
Microsoft® Windows Server™ 2003 Enterprise Edition
Microsoft® Windows Server™ 2003 Web Edition
- The product names of Windows NT® 4.0 are as follows:
Microsoft® Windows NT® Workstation 4.0
Microsoft® Windows NT® Server 4.0

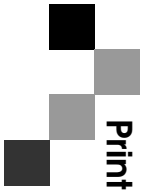

Printer/Scanner Unit Type 2018 Operating Instructions Scanner Reference