

2-stage RF power amplifier with LPF based on the PD85006L-E and STAP85050 RF power transistors

Introduction

This user manual briefly describes the function and use of the STEVAL-TDR011V1 demonstration board.

The board is a two-stage 50 W RF power amplifier which includes an output LPF (low-pass filter) for harmonics rejection. It also features power detection and a temperature sensor.

The main purpose of the board is to demonstrate the functioning and performance of the PD85006L-E and the STAP85050 devices from the LdmoST plastic family of RF power transistors.

The application is specifically designed for 2-way analog and digital mobile radios.

Figure 1. STEVAL-TDR011V1 demonstration board

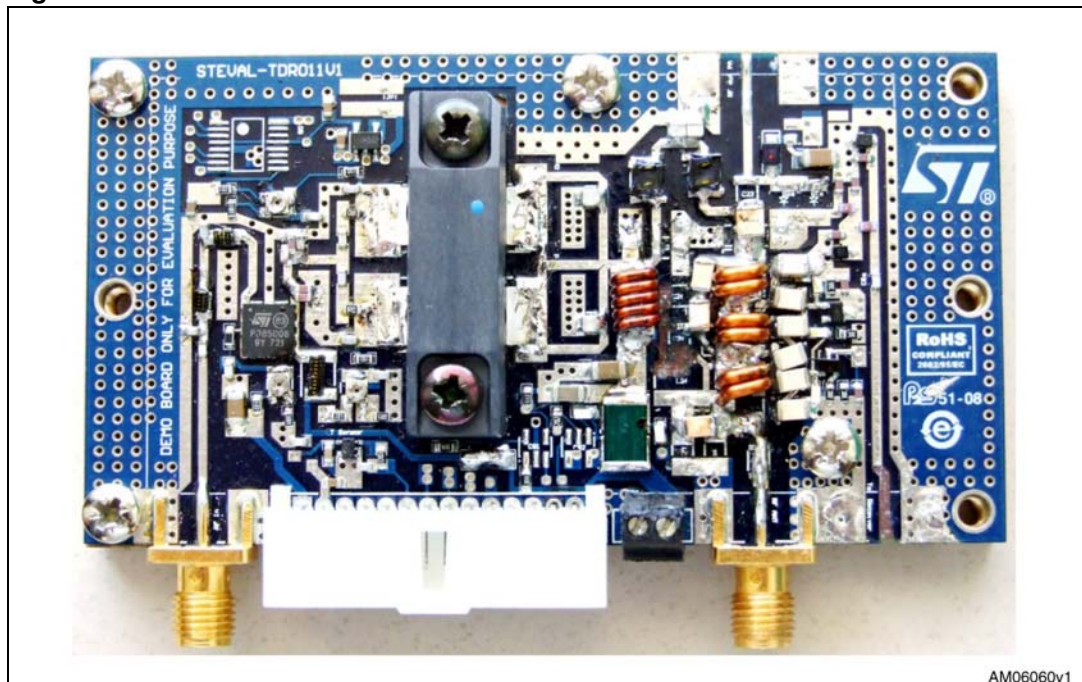

1 Schematic diagram

The schematic diagram in [Figure 2](#) shows the following stages:

- a) low pass band filter
- b) power detector
- c) thermal temperature sensor
- d) voltage regulator

Figure 2. STEVAL-TDR011V1 demonstration board schematic

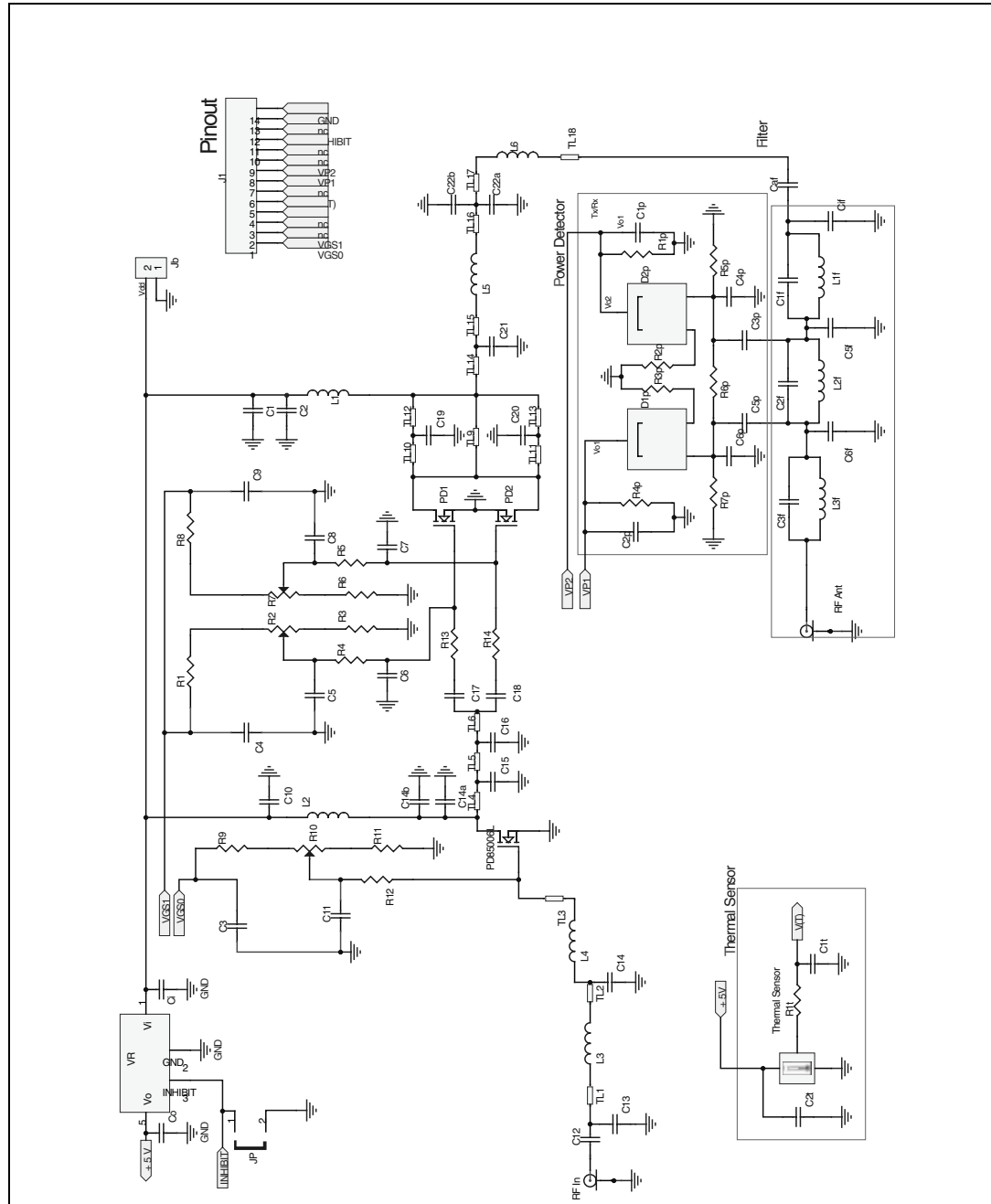

2 Testing procedure

2.1 Equipment required

1. DC power supply
2. RF power amplifier
3. RF signal generator
4. Power meters
5. Multimeter

2.2 Connector pin-out

Figure 3. Pin-out scheme

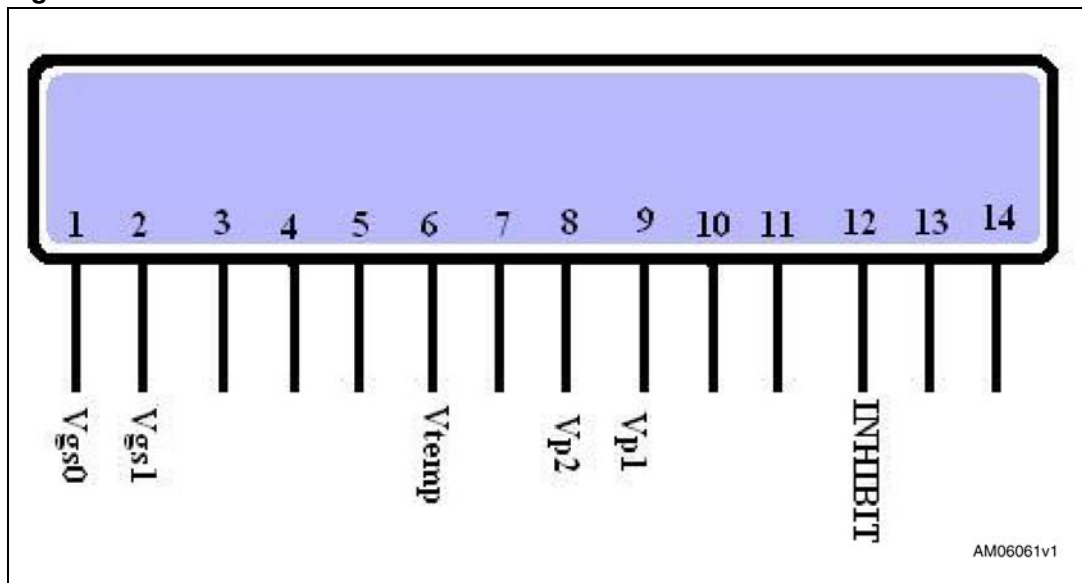

2.3 Testing

To ensure the correct functioning of the STEVAL-TDR011V1, perform the following procedure:

- a) Connect a power supply with a high current capability (about 10 A) and set 13.6 V on the drain.
- b) The board features a voltage regulator (VR) to supply 5 V to a temperature sensor (TS). Switch on the INHIBIT pin to activate the VR, and read the temperature with the TS according to the following transfer function:

Equation 1

$$T = -1481.96 + \sqrt{2.1962 \times 10^6 + \frac{(1.8639 - V_o)}{3.88 \times 10^{-6}}}$$

The INHIBIT is not internally pulled up, and cannot be left floating. Disable the device when connected to GND, or to a positive voltage less than 0.18 V.

- c) Select the bias gate mode by configuring the wires as shown in [Figure 6](#) and [Figure 7](#).

2.4 Thermal information

The temperature is taken on the surface of the PCB. If the PCB with its metal flange is cooled using an additional heat-sink ([Figure 5](#)), the main path of the heat (P_a) is easily dissipated, maintaining the PCB temperature below 70 °C ([Figure 4](#)).

Figure 4. Temperature trend

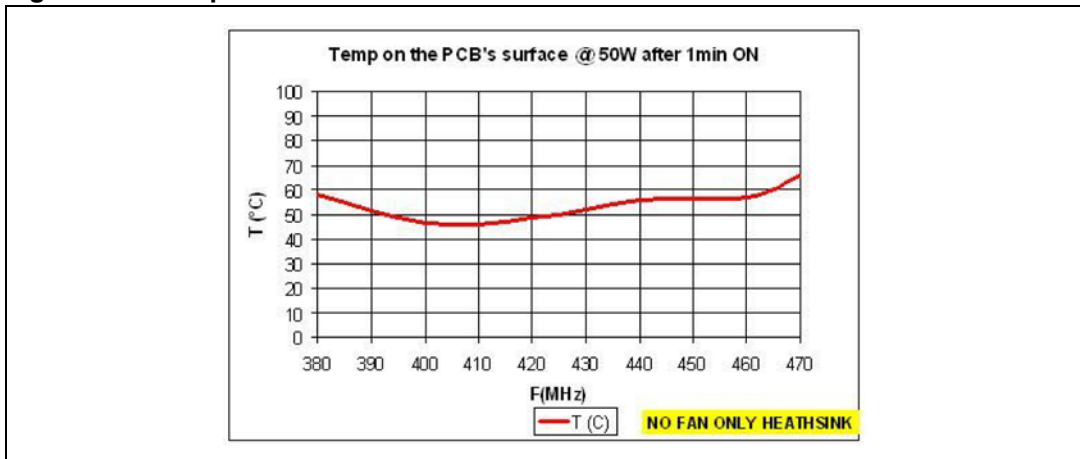
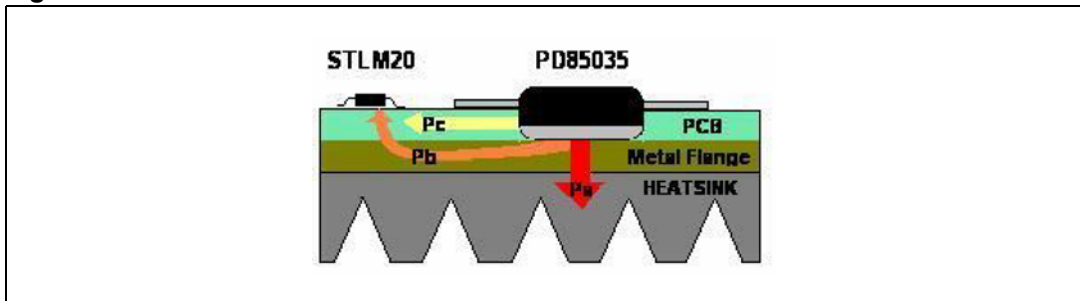
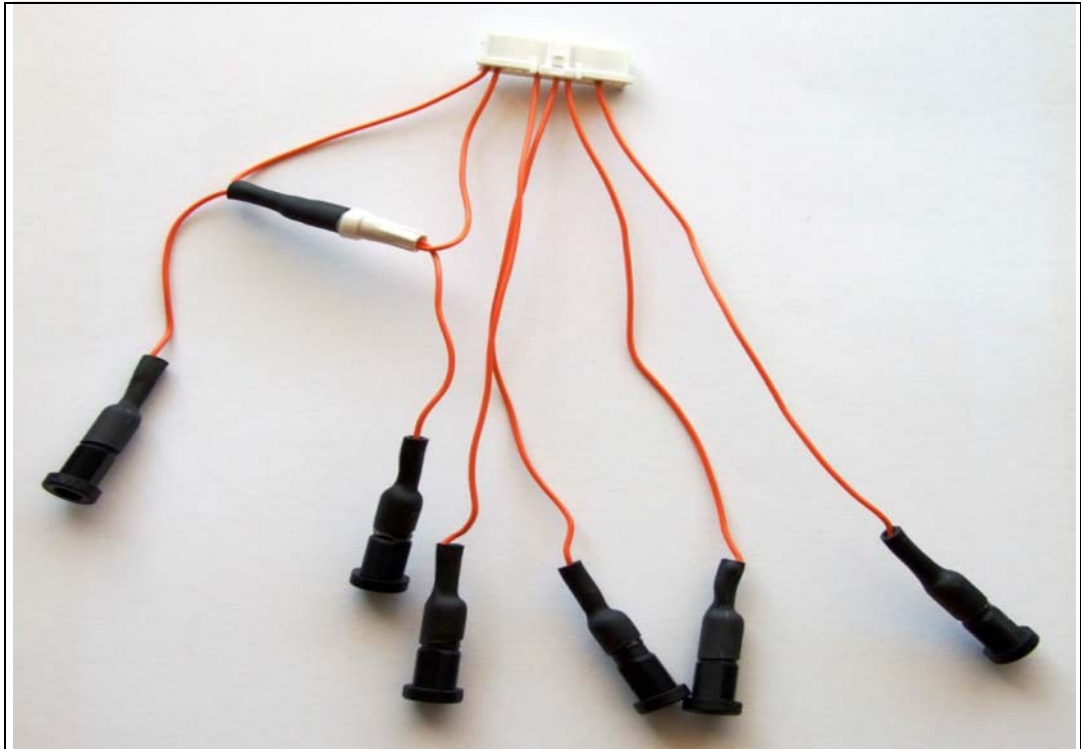

Figure 5. PCB with an additional heat-sink



In [Figure 6](#), the two wires are connected together in order to apply the same V_{gg} bias to both stages of the amplifier.

Figure 6. Bias mode selection - same V_{gg} bias to both amplifier stages



In [Figure 7](#), the two wires must be open in order to apply two independent V_{gg} biases on each stage of the amplifier.

Figure 7. Bias mode selection - independent V_{gg} bias on each amplifier stage

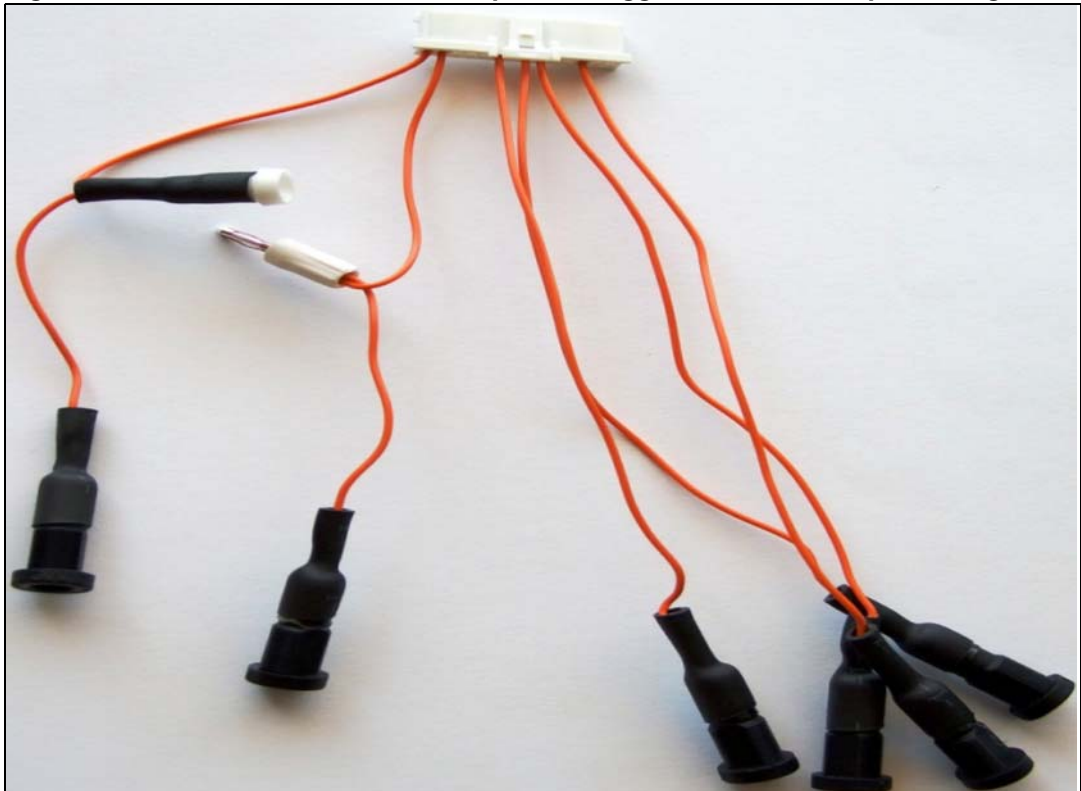

3 Revision history

Table 1. Document revision history

Date	Revision	Changes
18-Jan-2010	1	Initial release.

Please Read Carefully:

Information in this document is provided solely in connection with ST products. STMicroelectronics NV and its subsidiaries ("ST") reserve the right to make changes, corrections, modifications or improvements, to this document, and the products and services described herein at any time, without notice.

All ST products are sold pursuant to ST's terms and conditions of sale.

Purchasers are solely responsible for the choice, selection and use of the ST products and services described herein, and ST assumes no liability whatsoever relating to the choice, selection or use of the ST products and services described herein.

No license, express or implied, by estoppel or otherwise, to any intellectual property rights is granted under this document. If any part of this document refers to any third party products or services it shall not be deemed a license grant by ST for the use of such third party products or services, or any intellectual property contained therein or considered as a warranty covering the use in any manner whatsoever of such third party products or services or any intellectual property contained therein.

UNLESS OTHERWISE SET FORTH IN ST'S TERMS AND CONDITIONS OF SALE ST DISCLAIMS ANY EXPRESS OR IMPLIED WARRANTY WITH RESPECT TO THE USE AND/OR SALE OF ST PRODUCTS INCLUDING WITHOUT LIMITATION IMPLIED WARRANTIES OF MERCHANTABILITY, FITNESS FOR A PARTICULAR PURPOSE (AND THEIR EQUIVALENTS UNDER THE LAWS OF ANY JURISDICTION), OR INFRINGEMENT OF ANY PATENT, COPYRIGHT OR OTHER INTELLECTUAL PROPERTY RIGHT.

UNLESS EXPRESSLY APPROVED IN WRITING BY AN AUTHORIZED ST REPRESENTATIVE, ST PRODUCTS ARE NOT RECOMMENDED, AUTHORIZED OR WARRANTED FOR USE IN MILITARY, AIR CRAFT, SPACE, LIFE SAVING, OR LIFE SUSTAINING APPLICATIONS, NOR IN PRODUCTS OR SYSTEMS WHERE FAILURE OR MALFUNCTION MAY RESULT IN PERSONAL INJURY, DEATH, OR SEVERE PROPERTY OR ENVIRONMENTAL DAMAGE. ST PRODUCTS WHICH ARE NOT SPECIFIED AS "AUTOMOTIVE GRADE" MAY ONLY BE USED IN AUTOMOTIVE APPLICATIONS AT USER'S OWN RISK.

Resale of ST products with provisions different from the statements and/or technical features set forth in this document shall immediately void any warranty granted by ST for the ST product or service described herein and shall not create or extend in any manner whatsoever, any liability of ST.

ST and the ST logo are trademarks or registered trademarks of ST in various countries.

Information in this document supersedes and replaces all information previously supplied.

The ST logo is a registered trademark of STMicroelectronics. All other names are the property of their respective owners.

© 2010 STMicroelectronics - All rights reserved

STMicroelectronics group of companies

Australia - Belgium - Brazil - Canada - China - Czech Republic - Finland - France - Germany - Hong Kong - India - Israel - Italy - Japan - Malaysia - Malta - Morocco - Philippines - Singapore - Spain - Sweden - Switzerland - United Kingdom - United States of America

www.st.com