

**2018**

**ALUMINUM ELECTROLYTIC  
CAPACITORS**

**CONDUCTIVE POLYMER  
CAPACITORS**





# INDEX

## PRODUCT GUIDE

- 03 Precautions In Using Aluminum Electrolytic Capacitors
- 05 The Function Of Electrolytic Capacitors
- 06 Basic Electrical Characteristics
- 09 Reliability
- 10 Circuit Design
- 11 Caution For Mounting
- 13 Emergency Action/Storage Condition/Environment-Related Substances
- 14 The Characteristics Of Endurance Test
- 15 Ordering Code
- 19 Packing Information

## SURFACE MOUNT ALUMINUM ELECTROLYTIC CAPACITORS

Low Profile	Rated Voltage	Temperature Endurance	
27 CA General	4 - 100	2,000hrs.	85°C
31 CB General	4 - 100	1,000hrs.	105°C
35 CE Long Life	6.3 - 400	2,000hrs.	105°C
39 CZ Low Impedance, Low ESR	4 - 50	1,000hrs.	105°C
42 CX Ultra Low Impedance and Long Life	6.3 - 50	3,000~5,000hrs.	105°C
44 CD Ultra Low Impedance	6.3 - 50	2,000hrs.	105°C
47 CJ Long Life , High Reliability (*)	160 - 400	5,000hrs.	105°C
49 CH High Temperature , Ultra Low Impedance	6.3 - 50	2,000hrs.	125°C

## CONDUCTIVE POLYMER ALUMINUM SOLID ELECTROLYTIC CAPACITORS (\*)

### Surface Mount type

52 VP SMD, General (*)	2.5 - 25	2,000hrs.	105°C
55 VS SMD Long life, Ultra Low ESR (*)	4 - 20	5,000hrs.	105°C

### Radial lead type

57 PG High Ripple Current & Low ESR	2.5 - 25	2,000hrs.	105°C
60 PP 8mm Heigh, Ultra Low ESR	2.5 - 25	2,000hrs.	105°C
62 PR High Ripple, Ultra Low ESR (*)	2.5 - 6.3	2,000hrs.	105°C
64 PS Hybrid (*)	35 - 100	5,000hrs.	105°C
66 PH Long Life, Ultra Low ESR, High Reliability (*)	2.5 - 50	5,000hrs.	105°C
68 PT High Temperature, Low ESR, High Reliability (*)	6.3 - 25	2,000hrs.	125°C

## SCREW TYPE ALUMINUM ELECTROLYTIC CAPACITORS

70 NP General	10 - 250	2,000hrs.	85°C
75 NM Wide Temperature	25 - 450	2,000hrs.	105°C
79 NG Low Voltage, Large Capacity	10 - 100	2,000hrs.	85°C
82 NF Long Life for Inverter	400 - 450	5,000hrs.	85°C
84 NH High Temperature, Long Life for Inverter	10 - 100	5,000hrs.	105°C

(\*) = New Product

# INDEX

## RADIAL TYPE ALUMINUM ELECTROLYTIC CAPACITORS

Low Profile		Rated Voltage	Temperature Endurance	
89	S5 Super Miniature	4 - 50	1,000hrs.	105°C
91	S7 Super Miniature (*)	4 - 63	2,000hrs.	105°C
93	SS Super Miniature	4 - 63	1,000hrs.	105°C

### General , Low ESR, Low Impedance, High Ripple Current

95	SK For General	6.3 - 450	2,000hrs.	85°C
100	SE-K For General	6.3 - 450	1,000hrs.	105°C
105	SH For General	6.3 - 450	2,000hrs.	105°C
109	SG High Voltage ,High Ripple Current, Long Life ( Ballast & UPS)	160 - 500	5,000hrs.	105°C
112	SP Miniature, Long Life	160 - 450	10,000hrs.	105°C
114	SN None Polar	6.3 - 50	1,000hrs.	105°C
116	SB Low Leakage Current	6.3 - 100	1,000hrs.	105°C
120	SZ Ultra Low ESR	6.3 - 16	2,000hrs.	105°C
122	SQ High Ripple, Low Impedance	160 - 450	2,000hrs.	105°C
124	SC Low Impedance and Low ESR	6.3 - 450	3,000hrs.	105°C
129	SJ Low Impedance and High Ripple	6.3 - 100	1,000~5,000hrs.	105°C
134	SX Low Impedance, Low ESR	6.3 - 100	2,000~5,000hrs.	105°C
138	SY Low Impedance and Low ESR	6.3 - 100	3,000~6,000hrs.	105°C
144	TC Low Impedance and Long Life	6.3 - 100	8,000~10,000hrs.	105°C
148	SL Long Life and Low Impedance	6.3 - 450	3,000~7,000hrs.	105°C
155	ST Low Impedance and Long Life (Anhydrous)	6.3 - 63	4,000~10,000hrs.	105°C
158	SD High Ripple Current, Slim Type	160 - 450	5,000hrs.	105°C
161	SV High Voltage High Ripple Current, Slim Type (*)	160 - 450	10,000~12,000hrs.	105°C
163	TA Low Impedance and Long Life	6.3 - 100	4,000~10,000hrs.	105°C
171	TE LED Lighting, Ultra Long Life	160 - 450	12,000~20,000hrs.	105°C

### High Temperature

173	SU Higher Temperature Range	10 - 63	2,000hrs.	125°C
175	SW High Temperature and Long Life	10 - 63	2,000~5,000hrs.	125°C

## LARGE CAN ALUMINUM ELECTROLYTIC CAPACITORS

177	LH Snap-in, General	63 - 500	2,000hrs.	85°C
186	LF Snap-in, General (*)	100 - 500	3,000hrs.	85°C
192	LG Snap-in, General	10 - 500	2,000hrs.	105°C
200	LV Snap-in, Long Life, High Ripple Current	10 - 500	3,000hrs.	105°C
207	LC Snap-in, Long Life, High Ripple Current	160 - 500	5,000hrs.	105°C
210	LS Snap-in, Long Life, High Ripple Current (*)	350 - 500	7,000hrs.	105°C

(\*) = New Product

## PRECAUTIONS IN USING ALUMINUM ELECTROLYTIC CAPACITORS

Please note the following recommendations when using capacitors:

1. When using Electrolytic capacitors on DC applications, polarization is required as well as the confirmation of the polarity of the course. Otherwise, the circuit life may be shortened or the capacitor may be damaged by the insertion on reverse polarity.  
Use non-polar capacitors on those circuits with occasionally reverse polarity or unknown polarity. Also note that do not use electrolytic capacitors for AC applications.
2. Do not apply a voltage exceeding the capacitor rated voltage, that will cause the capacitor be damaged by increased leakage current.
3. Use the electrolytic capacitor at current value under the permissible ripple range.
4. Use the electrolytic capacitors according to the specified operation temperature range. Using at room temperature will ensure a longer life.
5. The electrolytic capacitor is not suitable for circuits which are charged and discharged repeatedly. If used in circuits which are charged and discharged repeatedly, the capacitance value may drop or the capacitor may be damaged. Please consult our engineering department for assistance in these applications.
6. When capacitors have been left unused for a long time, use them only after due voltage treatments. Long storage time may raise capacitor's leakage current level. In such cases, be sure to provide the necessary voltage treatment before use.
7. Be careful of the temperature and time conditions when soldering. Adverse effects may happen on the electrical characteristics and insulation sleeve of electrolytic capacitors may occur in case the soldering temperature is too high or dipping time too long. For small-size electrolytic capacitors, proper dipping shall be executed at temperature lower than 260°C for less than 10 seconds.
8. Clean circuit boards after soldering. Halogenated hydrocarbon cleaning solvents are not recommended to clean capacitors with exposed end seals. If halogenated solvent is required, order and use capacitors in Epoxy-coated end seals.

9. Do not apply excessive force to the lead wires or terminals. It may break the components or disconnect the internal elements on the board. (For strength of terminals, please refer to JIS C5102 and C5141.)
10. Keep the clearance between the vent of the capacitor and the case of the appliance. Do not block the operation of the vent, unless otherwise described on the catalogues or product specifications. The narrower clearance may adversely affect the vent operation and result in the capacitor explosion.

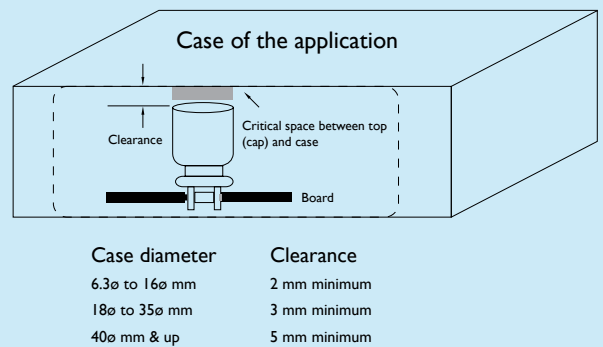

Fig. I-1

### Attention

- The description in this catalogue is subject to change without prior notice for product improvement. Therefore, please confirm the specification before ordering products.
- The general characteristics, reliability data, etc., described in this catalogue should not be construed as guaranteed values; they are merely standard values.
- Before using the products, please read the notes in this catalogue carefully for proper use.

## TECHNICAL CONCEPTS

### The Material and Structure of Electrolytic Capacitors

Electrolytic Capacitor is a simple module. It simply contains an insulator between relative conductors in an electrode. The major internal raw material contains an element constructed by an separator paper wrap around the anode foil and cathode foil, which is then impregnated with the electrolyte, inserted into an aluminum case and sealed.

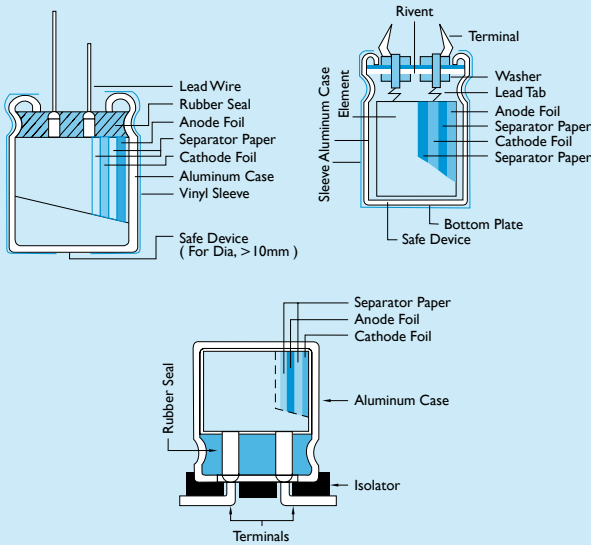

Fig. 1-2

### Production Processes

1. Etching: The process to increase surface area of aluminum foil by using chemical erosion or chemical corrosion method is called Etching. Normally chemical corrosion method uses the ripple current of electrolyte, combination of the liquid and temperature to determine the size, shape, and quantity of the dense network of microscopic channels on the aluminum foil surface.
2. Forming: The production process of the anode aluminum foil of electrolytic capacitors is by anodic oxidation of the etched aluminum foil. The production of the cathode aluminum foil sometimes involves oxidation in special purposes. This anodic oxidation process is called Forming. Boric acid or organic acid is used for high voltage forming and phosphoric acid or ammonium adipate is used for low voltage forming in order to obtain stable natural oxide layer of  $Al_2O_3$ .
3. Slitting: The cutting of the aluminum foil and separator paper according to the required length.
4. Winding: The stitching or cold welding of cut anode and cathode foils and tab terminal, and wrap the electrolytic paper in between the anode and cathode, then fix the end with glue or sticky tape, and attached leads is called the capacitor "element".
5. Impregnation: The process of eliminating the water from the elements by pressurizes or vacuum in order to soak the element with the electrolyte is called Impregnation. The elements fully filled with electrolyte is then centrifuged to remove excess electrolyte.
6. Assembly: The elements are sealed with rubber to stop the leakage of electrolyte then put into a sleeve to form the final product.
7. Aging: The purpose of aging is to repair the oxide layer damage by recharging and electrolyte.

## THE FUNCTION OF ELECTROLYTIC CAPACITORS

---

The electrolytic capacitors could be widely used in appliance (ie. TV, radio, audio equipment, washing machine and air conditioner...etc.), computer equipment (motherboard, image device & the peripherals such as the printer, drawing device, scanner... etc.), communication equipment, estate equipment, measuring instrument and also the industrial instrument, air plane, firebomb, satellite...etc. as a piloting equipment.

\* According to the inflict electric wave & using purpose, it basically with some classified purposes as below:

### DC Voltage:

1. For Momentary High Voltage: For using to the impulse generator such as the shock wave resistance test of the heavy electric machine.
2. For High Electric Current: For using to the welding machine, X-Ray facility, copy machine and discharge-processing device.
3. For DC High Voltage: The electrolytic capacitor and rectifier composing, a special DC high voltage been happened after charged, for using to the power of electronic microscope and accelerator.
4. For Integration & Memory: For either memory circuit or compare circuit inside the calculator.

### The DC Voltage that with Alternate Ingredient:

1. For Wave Filter: Combination with the chip resistor & inductor as a internet, to be passed by DC current or some frequency to closure or decline some other frequency.
2. For Bypass: A parallel track that outside from the circuit element, the IC (integrated circuit) has been rapidly developed in these years and thus a miniaturization or chip of electrolytic capacitors for bypass was conducted.
3. For Coupling: Combination of the electrolytic capacitor; chip resistor and inductor and thus coupling together.
4. For Arising of Toothed Wave: Composing of RC charge/discharge circuit through the electrolytic capacitor as well as the resistor to generate a toothed wave to be created.
5. For Reverse (Change) of Circuit: The equipment for changing the AC voltage to DC voltage.

### For AC Voltage:

1. For Power Improving: Connect the end loading of layout transporting & electrolytic capacitor for power improving.
2. For Wave Filter: Prevention of external interference in SCR circuit, use the LC wave filter circuit to inhibit or erase the interference.
3. For Phase Across: Phase change of the inductive electromotor (motor) with single phase.

# BASIC ELECTRICAL CHARACTERISTICS

## Capacitance (ESC)

The capacitive component of the equivalent series circuit (equivalent series capacitance ESC) is determined by applying an alternate voltage of 0.5V at a frequency of 120 Hz.

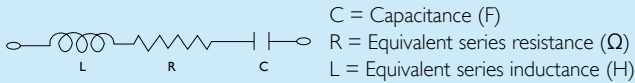

Fig. I-3 Simplified equivalent circuit diagram of an electrolytic capacitor

- Temperature Dependence of the Capacitance

The capacitance of an electrolytic capacitor depends on the temperature. With decreasing temperature, the viscosity of the electrolyte increases and reduces its conductivity which leads to the capacitance decrease. Furthermore temperature drifts cause armature dilatation and therefore capacitance changes (up to 20%, depending on the series considered, from 0 to 80 °C). This phenomenon is more evident on electrolytic capacitors than other types.

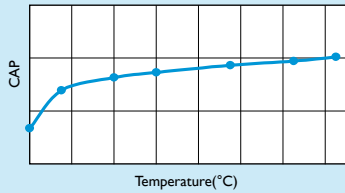

Fig. I-4 Capacitance Change vs. Temperature

- Frequency Dependence of the Capacitance

The effective capacitance value is derived from the impedance curve, as long as the impedance is still in the range where the capacitance component is dominant.

$$C = \frac{I}{2\pi f Z}$$

C = Capacitance (F)  
 f = Frequency (Hz)  
 Z = Impedance (Ω)

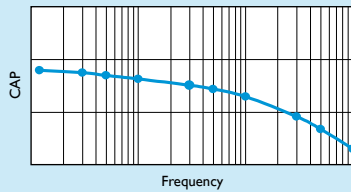
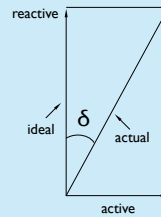

Fig. I-5 Capacitance Change vs. Frequency

## Dissipation Factor (tan δ)

The dissipation factor is the ratio between the active and the reactive power for a sinusoidal waveform voltage. It can be considered as a measurement of the gap between an actual and an ideal capacitor:



$$D.F. = \tan \delta \times 100 (\%) = \omega CR \times 100 (\%) = 2\pi fCR \times 100 (\%)$$

where: R = Equivalent Series Resistance  
 C = Equivalent Series Capacitance  
 $\omega = 2\pi f$

Fig. I-6 The tanδ is measured with the same set up as for the series capacitance ESC

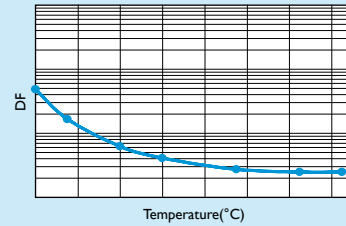

Fig. I-7 Dissipation Factor vs. Temperature

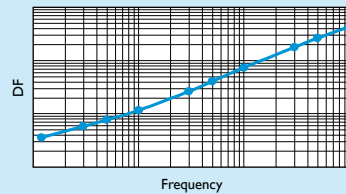

Fig. I-8 Dissipation Factor vs. Frequency



# BASIC ELECTRICAL CHARACTERISTICS

## Equivalent Series Resistance (ESR)

The equivalent series resistance is the resistive component of the equivalent series circuit. The ESR value depends on frequency and temperature and is related to the  $\tan \delta$  by the following equation:

$$ESR = \frac{\tan \delta}{2\pi fESC}$$

$ESR$  = Equivalent Series Resistance ( $\Omega$ )  
 $\tan \delta$  = Dissipation Factor  
 $ESC$  = Equivalent Series Capacitance (F)  
 $f$  = Frequency (Hz)

The tolerance limits of the rated capacitance must be taken into account when calculating this value.

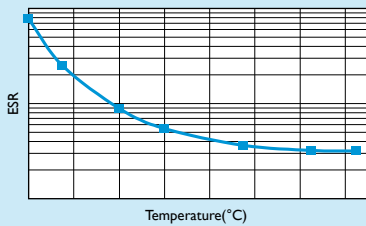

Fig. I-9 ESR Change vs. Temperature

The resistance of the electrolyte decreases strongly with increasing temperature.

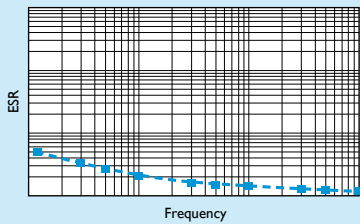

Fig. I-10 ESR Change vs. Frequency

## Impedance (Z)

The impedance of an electrolytic capacitor results from below circuit formed by the following individual equivalent series components.

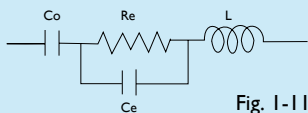

Fig. I-11

$C_o$  = Aluminum oxide capacitance (surface and thickness of the dielectric).  
 $R_e$  = Resistance of electrolyte and paper mixture (other resistances not depending on the frequency are not considered: tabs, plates, and so on).

$C_e$  = Electrolyte soaked paper capacitance.

$L$  = Inductive reactance of the capacitor winding and terminals.

The impedance of an electrolytic capacitor changes depending on the frequency and the temperature.

The impedance as a function of frequency (sinusoidal waveform) under a certain temperature can be represented as follows:

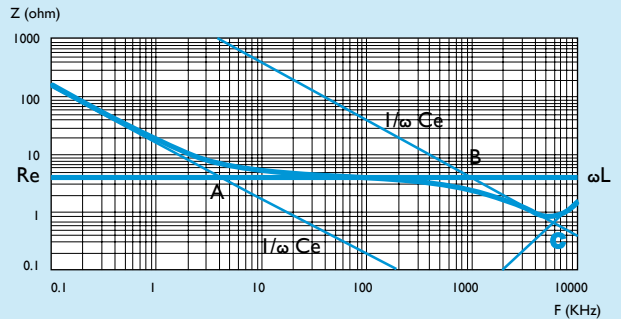

Fig. I-12

1. Capacitive reactance predominates at low frequencies
2. With increasing frequency, the capacitive reactance  $X_c = 1/\omega C_o$  decreases until it reaches the order of magnitude of the electrolyte resistance  $R_e$  (A)
3. At even higher frequencies, the resistance of the electrolyte predominates:  $Z = R_e$  (A-B)
4. When the capacitor's resonance frequency is reached ( $\omega_0$ ), capacitive and inductive reactance mutually cancel each other  $1/\omega C_e = \omega L$ ,  $\omega_0 = \text{SQRT}(1/LC_e)$  (C)
5. Above this frequency, the inductive reactance of the winding and its terminals ( $X_L = Z = \omega L$ ) becomes effective and leads to an increase in impedance. Generally speaking it can be estimated that  $C_e \approx 0.01 C_o$

## BASIC ELECTRICAL CHARACTERISTICS

The impedance as a function of frequency (sinusoidal waveform) for different temperature values can be represented as follows (typical values):

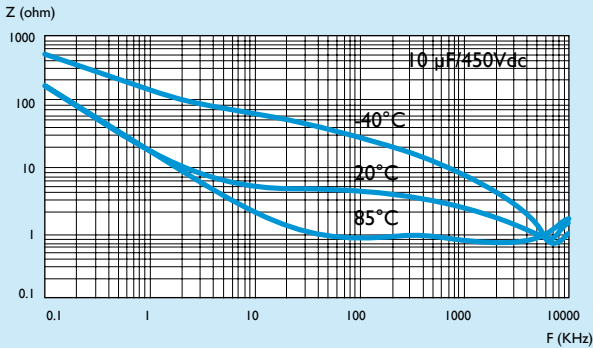

Fig. I-13

$R_e$  is the most temperature dependant component of electrolytic capacitor equivalent circuit. The electrolyte resistivity will decrease when the temperature rises. In order to obtain a low impedance value in all temperature range,  $R_e$  must be as little as possible, but too low  $R_e$  values means a very aggressive electrolyte and a shorter life of the electrolytic capacitor at the high temperatures. A compromise must be reached.

### Leakage Current (L.C.)

Due to the aluminum oxide layer that serves as a dielectric, a small current will continue to flow even after a DC voltage has been applied for long periods. This current is called leakage current. A high leakage current flows after applying a voltage to the capacitor and then decreases in few minutes (e.g. after a prolonged storage without any applied voltage). In the course of the continuous operation, the leakage current will decrease and reach an almost constant value. After a voltage free storage the oxide layer may deteriorate, especially at high temperature. Since there are no currents to transport oxygen ions to the anode, the oxide layer is not regenerated. The result is that a higher than normal leakage current will flow when a voltage is applied after prolonged storage. As the oxide layer is regenerated in use, the leakage current will gradually decrease to its normal level. The relationship between the leakage current and the voltage applied at constant temperature can be shown schematically as follows.

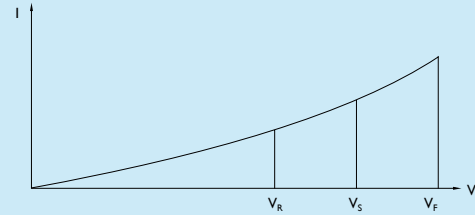

Fig. I-14

Where:

$V_F$  = Forming Voltage

If this level is exceeded, a large quantity of heat and gas will be generated and the capacitor could be damaged.

$V_R$  = Rated Voltage

This level represents the top of the linear part of the curve.

$V_S$  = Surge Voltage

It lies between  $V_R$  and  $V_F$ : the capacitor can be applied with  $V_S$  for short periods only.

# RELIABILITY

## Bathtub Curve

Aluminum electrolytic capacitors failure rates are shown by the following bathtub curve.

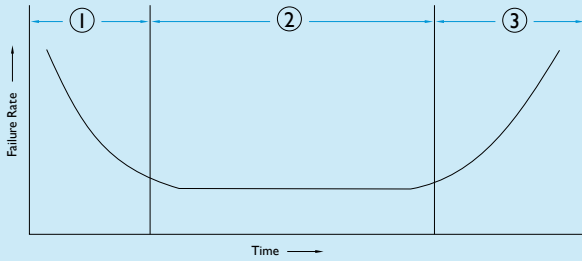

Fig. I-15 Bathtub Curve

1. Initial Failure Period  
Deficient Capacitors include any products before dispatch that may have some deficiency caused by the design, production process or use in inappropriate environments.
2. Random Failure Period  
The capacitors have a low defect ratio in the period after it has been stabilized.
3. Wear Out Failure Period  
The performance of capacitors will decrease with an increase in usage period. The malfunction rate may vary due to the structural design.

Table-I Failure Modes and Causes

Failure Modes	Internal Causes	Primary Factors		
		Mismanaged Production	Mishandled Application	Unavoidable Factors in Normal Service
Short Circuit	Short Circuit Between Electrodes	Burred Foil / Metal Particle		
	Dielectrical Break of Oxide Layer	Local Deficiency in Oxide Layer		
	Dielectrical Break of Separator		Mechanical Stress	
Open Circuit	Disconnection of Terminal Construction		Mechanical Stress	
	Poor Terminal Connection		Poor Connection	
Capacitance Drop	Less Electrolyte			Deterioration with Time
	Electrolyte Vaporization		Excessive Thermal Stress	
tanδ (ESR) Increase	Anode Foil Capacitance Drop		Excessive Operating Voltage	
	Cathode Foil Capacitance Drop		Reverse Voltage	
Leakage Current Increase	Deterioration of Oxide Layer		Excessive Ripple Current	
	Corrosion		Excessive Charge-Discharge Duty	
Open Vent	Internal Pressure Rise		Contamination by Chloride	Chloride Contamination by Assembly Board Cleaning
Electrolyte Leakage	Poor Sealing			Poor Sealing

## CIRCUIT DESIGN

### Environmental and Mounting Conditions

Please make sure the environmental and mounting conditions are compliant with their specifications in this catalog.

### Operating Temperature, Equivalent Series Resistance(ESR), Ripple Current and Load Life

MTTF(Mean-Time-To-Failure) means the useful life at room temperature 25°C

#### 1. Load Life ( $L_0$ )

If the capacitor's max. operating temperature is at 105 °C (85°C), then after applying capacitor's rated voltage (WV) for  $L_0$  hours at 10°C (85°C), the capacitor shall meet the requirements in detail specification. where  $L_0$  is called "load life" or "useful life (life time) at 105 °C (85°C)".

$$L_x = L_0 \times 2^{(T_0 - T_x) / 10} \times K^{-\Delta T_x / 5}$$

where  $\Delta T_x = \Delta T_0 \times (I_x / I_0)^2$

$$I_x > I_0, K = 4; I_x \leq I_0, K = 2$$

#### 2. Ripple Life ( $L_r$ )

If the capacitor's max. operating temperature is at 105 °C (85°C), then after applying capacitor's rated voltage (WV) with the ripple current for  $L_r$  hours at 105 °C (85°C), the capacitor shall meet the requirements in detail specification. where  $L_r$  is called "ripple life" or "useful ripple life (ripple lifetime) at 105 °C (85°C)".

$$L_x = L_r \times 2^{(T_0 - T_x) / 10} \times K^{(\Delta T_0 - \Delta T_x) / 5}$$

where  $\Delta T_x = \Delta T_0 \times (I_x / I_0)^2$

$$I_x > I_0, K = 4; I_x \leq I_0, K = 2$$

The (ripple) life expectancy at a lower temperature than the specified maximum temperature may be estimated by the following equation, but this expectancy formula does not apply for ambient below +40°C.

$L_0$  : Expected life period (hrs) at maximum operating temperature allowed

$L_r$  : Expected ripple life period (hrs) at maximum operating temperature allowed

$L_x$  : Expected life period (hrs) at actual operating temperature

$T_0$  : Maximum operating temperature (°C) allowed

$T_x$  : Actual operating ambient temperature (°C)

$I_x$  : Actual applied ripple current (mA/rms) at operating frequency  $f_0$  (Hz)

$I_0$  : Rated maximum permissible ripple current  $I_R$  (mA/rms) × frequency multiplier ( $C_f$ ) at  $f_0$  (Hz)

Ripple Current calculation: no need Temperature Multiplying Factor

$I_x$  Should be 80% equal or more of  $I_0$

$T_0$  : Maximum temperature rise (°C) for applying  $I_0$  (mA/rms) = 5

$T_c$  : Temperature rise (°C) of capacitor case for applying  $I_x$  (mA/rms)

$T_x$  : Temperature rise (°C) of capacitor element for applying  $I_x$  (mA/rms) =  $K_c \Delta T_c = K_c (T_c - T_x)$

where  $T_c$  is the surface temperature (°C) of capacitor case  $T_x$  is ditto.  $K_c$  is transfer coefficient between element and case of capacitor from table below :

Dia	≤8ø	10ø	12.5ø	13ø	16ø	18ø	22ø	25ø	30ø	35ø
Kc	1.10	1.15	1.20	1.20	1.25	1.30	1.35	1.40	1.50	1.65

#### 3. The Formula of Equivalent Series Resistance (ESR)

The operating frequency of ESR, DF, f & C must be the same, usually are 120 Hz.

$$ESR = DF / 2\pi f C \dots \dots \dots (2)$$

Where DF = Dissipation Factor (tanδ)

f = Operating Frequency (Hz)

C = Capacitance (F)

#### 4. Estimation of Life Considering the Ripple Current

The ripple current affects the life of a capacitor because the internal loss (ESR) generates heat. The heat can be calculated by:

$$P = I^2 R \dots \dots \dots (3)$$

Where I = Ripple current (Arms.)

R = ESR (Ω)

#### 5. Estimation of the Capacitor Temperature Increase

$$\Delta T = I^2 R / AH \dots \dots \dots (4)$$

Where ΔT = Temperature increase in the capacitor core (degree)

I = Ripple current (Arms)

R = ESR (Ω)

A = Surface area of the capacitor (cm<sup>2</sup>)

H = Radiation coefficient (Approx. 1.5~2.0'10<sup>-3</sup> W / cm<sup>2</sup>)

The values of ΔT varies depending on the capacitor types and operating conditions. The usage is generally desirable if ΔT remains less than 5°. The measuring point for temperature increase due to ripple current is shown below

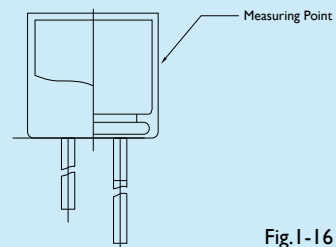

Fig.1-I6

## CIRCUIT DESIGN

---

### Conditions of Use

Aluminum Electrolytic Capacitors must not be used under the following conditions:

1. When capacitors expose to high humidity or humidity condensation situation such as water or saltwater spray, oil spray, steam.
2. When capacitors are exposed to toxic gases such as hydrogen sulfide, sulfurous acid, nitrous acid, chlorine, ammonium... etc.
3. When capacitors are exposed to ozone, ultraviolet rays and radiation.
4. When severe vibration or shock occurs and exceeds the conditions specified in the catalog or datasheet.
5. Aluminum Electrolytic Capacitors should be electrically isolated from the following circumstances
  - Aluminum case, cathode lead wire, and anode lead wire.
  - Auxiliary terminals of snap-in type, anode terminal, and outward terminal.

### Recommended Design Considerations

When designing a circuit board, please be noted to the following points:

1. Make the hole spacing of the PC board match the lead space for the capacitor.
2. There should not be any circuit pattern or circuit wire above the capacitors.
3. It is suggested to make a gas release hole when the capacitor's vent is placed toward the PC board.
4. Do not install screw terminal capacitor upside down. When place a screw terminal capacitor in a horizontal mount, the positive terminal must be in the upper position.
5. Do not locate any wiring or circuit patterns directly above the capacitor's vent.

---

## CAUTION FOR MOUNTING

---

### Caution Before Assembly

1. When the capacitors that are removed from PC board for the measuring electrical characteristics purpose at a periodical inspection, can be recycled to the same position. However, when mounting and applying electricity in unit, the capacitors cannot be recycled afterwards.
2. Aluminum Electrolytic Capacitors may accumulate charge during storage. In this case, discharge through a 1K $\Omega$  resistor before use.
3. Leakage current of Aluminum Electrolytic Capacitors may be increased during long storage time. In this case, the capacitors should be subjected to voltage treatment through a 1K $\Omega$  resistor before use.

### In the Assembly Process

1. Please confirm ratings before installing capacitors on the PC board.
2. Please confirm polarity before installing capacitors on the PC board.
3. Do not make capacitors drop on the floor or use a dropped capacitor.

4. Be careful not to deform the capacitor during installation.
5. The snap-in type of capacitors should be mounted firmly on the PC board without a gap between the capacitor body and the surface of PC board.
6. Avoid excessive force when clenching lead wire during auto-insertion process.
7. Avoid excessive shock to capacitors by automatic insertion machine, during mounting, parts inspection or centering operations.
8. Please utilize supporting material such as strap or adhesive to mount capacitors to PC board when it is anticipated that vibration or shock is applied.

### Soldering

1. All YAGEO's cp wires of electrolytic capacitors are lead free. (Pb).
2. Soldering conditions (temperatures, times) should be within the specified conditions which are described in the catalog or specification sheets.

## CAUTION FOR MOUNTING

- If it is necessary that the leads must be formed due to a mismatch of the lead space to hole space on the board, bend the lead prior to soldering without applying too much stress to the capacitor.
- If soldering capacitor has to be withdrawn from the PW board by soldering iron, the capacitor should be removed after the solder has melted completely in order to avoid stress to the capacitor or lead wires.
- Soldering iron should never touch the capacitor's body.

### Flow Soldering

- Do not dip capacitor's body into melted solder.
- Din of flow soldering for the capacitors should be limited at 260°C, 10 seconds.
- Flux should not be adhered to capacitor's body but only to its terminals.
- Other devices which are mounted near capacitors should not touch the capacitors.

### Reflow Soldering Condition

- For reflow, use a thermal condition system such as infrared radiation or hot blast. Vapor heat transfer systems are not recommended.
- Observe proper soldering conditions (i.e. temperature, time, etc.)
- Do not exceed the specified limits.
- Repeated reflowing :
  - \* Avoid reflowing twice if possible.
  - \* If repeated reflowing is unavoidable, contact Yageo after measuring the first and the second reflow profiles and reflow interval at your side.

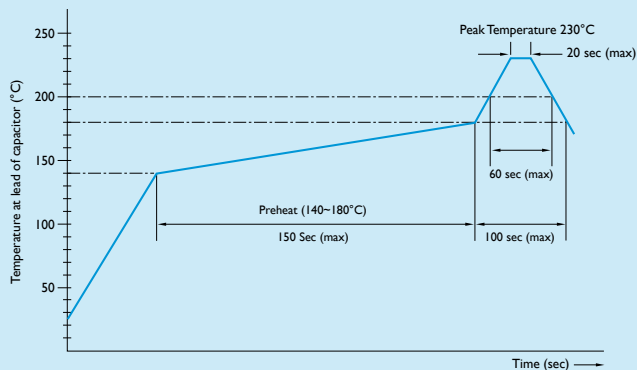

Fig. I-17 Reflow Soldering Condition

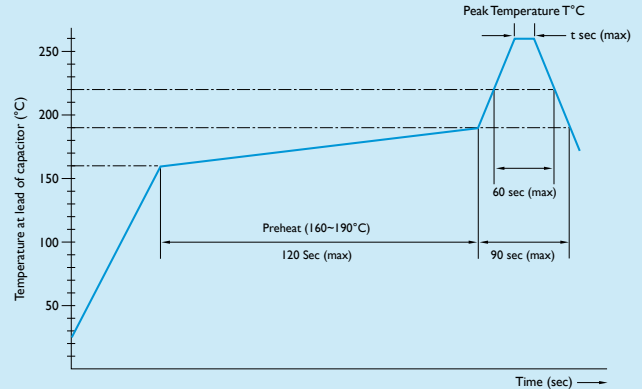

Fig. I-18 Lead Free Type Reflow Soldering Condition

SIZE	Temperature	t sec (max.)
ø4 ~ ø5 (4V ~ 50V)	250	10
	260	5
ø6.3 ~ ø10 (4V ~ 50V)	250	5

### Cleaning

- Satisfied characteristic of JIS C 5101.
- Aluminum Electrolytic Capacitors may be damaged by corrosion that is caused by any halogenated hydrocarbon solvents Ex: HCH(Cl)2). All of our products are non-solvent-proof, cleaning recommendation are as followed.  
Application: An type and rating  
Cleaning agents: pine Alpha ST-100S, Clean Through 750H/750L/710M, Sanelek B-12, Aqua Cleaner 210SEP, Techno Care FRW14~17, Iso-propyl Alcohol  
Cleaning conditions: Total cleaning time shall be within 5 minutes by immersion, ultrasonic or other method. (Temperature of the cleaning agent shall be 60°C or lower). After cleaning, capacitors should be dried using hot air for minimum of 10 minutes along with the PC board.

Hot air temperature should be below the maximum operating temperature of the capacitor. Insufficient drying after water rinse may cause appearance problems, sleeve may shrink, or the bottom-plate may bulge, etc. . .

Please inform Yageo in advance the solvent name and conditions for your PWB Cleaning.

## EMERGENCY ACTION

---

1. If you see smoke due to the operation of safety vent, turn off the main switch or pull out the plug.
  2. Do not put your face near the safety vent as gas which is over 100°C will be emitted when the safety vent operates. If the gas has entered your eyes, please rinse your eyes immediately with water. If you breathe in the gas, immediately wash out your mouth and throat with water. Do not ingest electrolyte. If your skin is exposed to electrolyte, please wash it immediately with soap and water.
- 

## STORAGE CONDITION

---

1. Aluminum electrolytic capacitors should not be stored in high temperatures or high level of humidity. The suitable storage condition is 5 °C ~ 35 °C and less than 75% in relative humidity.
  2. Aluminum electrolytic capacitors should not be stored in damp conditions such as water, saltwater spray or oil spray.
  3. Do not store aluminum electrolytic capacitors in an environment full of hazardous gases (hydrogen sulfide, sulfurous acid, nitrous acid, chlorine, ammonium, etc.)
  4. Aluminum electrolytic capacitors should not be stored under exposure to ozone, ultraviolet rays or radiation.
  5. If a capacitor has been stored more than a year under normal temperature (shorter time if higher temperature) and it shows increased leakage current, then a treatment by voltage application is recommended.
- 

## ENVIRONMENT – RELATED SUBSTANCES

---

All YAGEO capacitors comply to RoHS requirements (Restriction of Hazardous Substances) where Chromium VI (Cr+6), Cadmium (Cd), Mercury (Hg), Lead (pb), polybrominated biphenyls (PBBs) and Polybrominated biphenyl/diphenyl ethers (PBDEs / PBDEs) have not detected (lower than MDL (Method Detection Limit)) per SGS certification test report.

---

## DISPOSAL

---

Please dispose capacitors in either of the following ways:

1. Incinerate the capacitors after making a hole on the capacitor body.
  2. A capacitor disposal specialist in burying procedure handling is recommended.
-

# THE CHARACTERISTICS OF ENDURANCE TEST

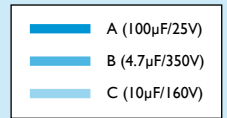
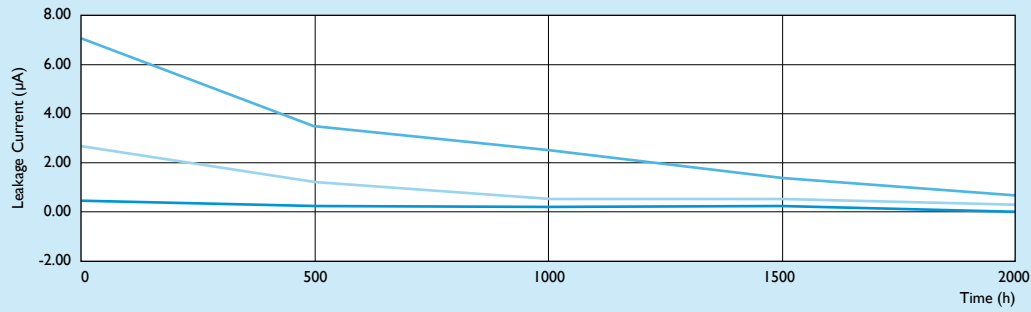
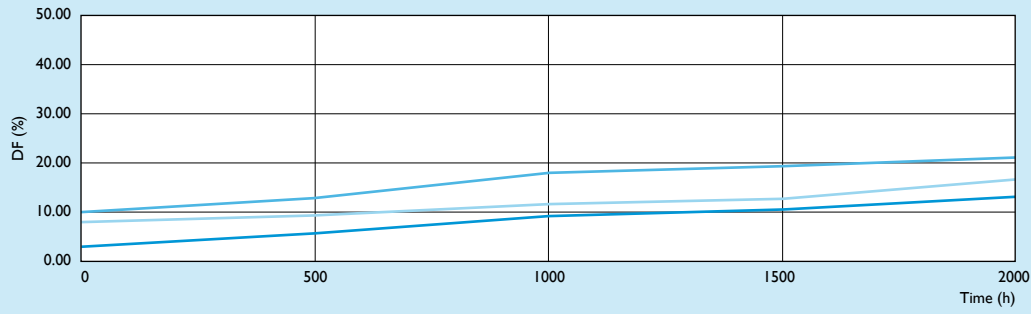
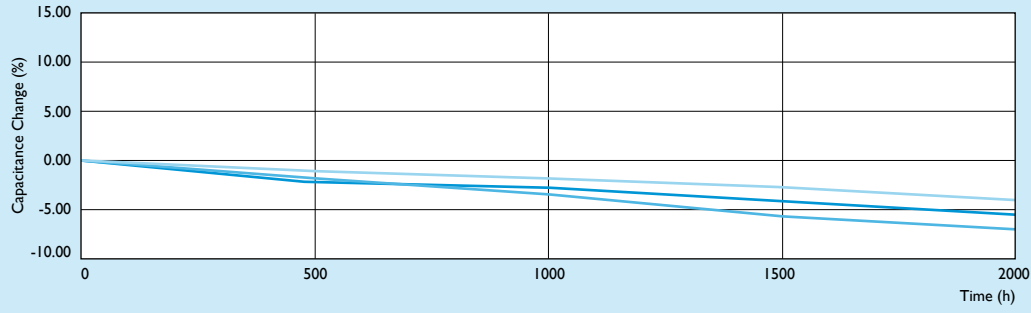



# MINIATURE & POLYMER ORDERING CODE

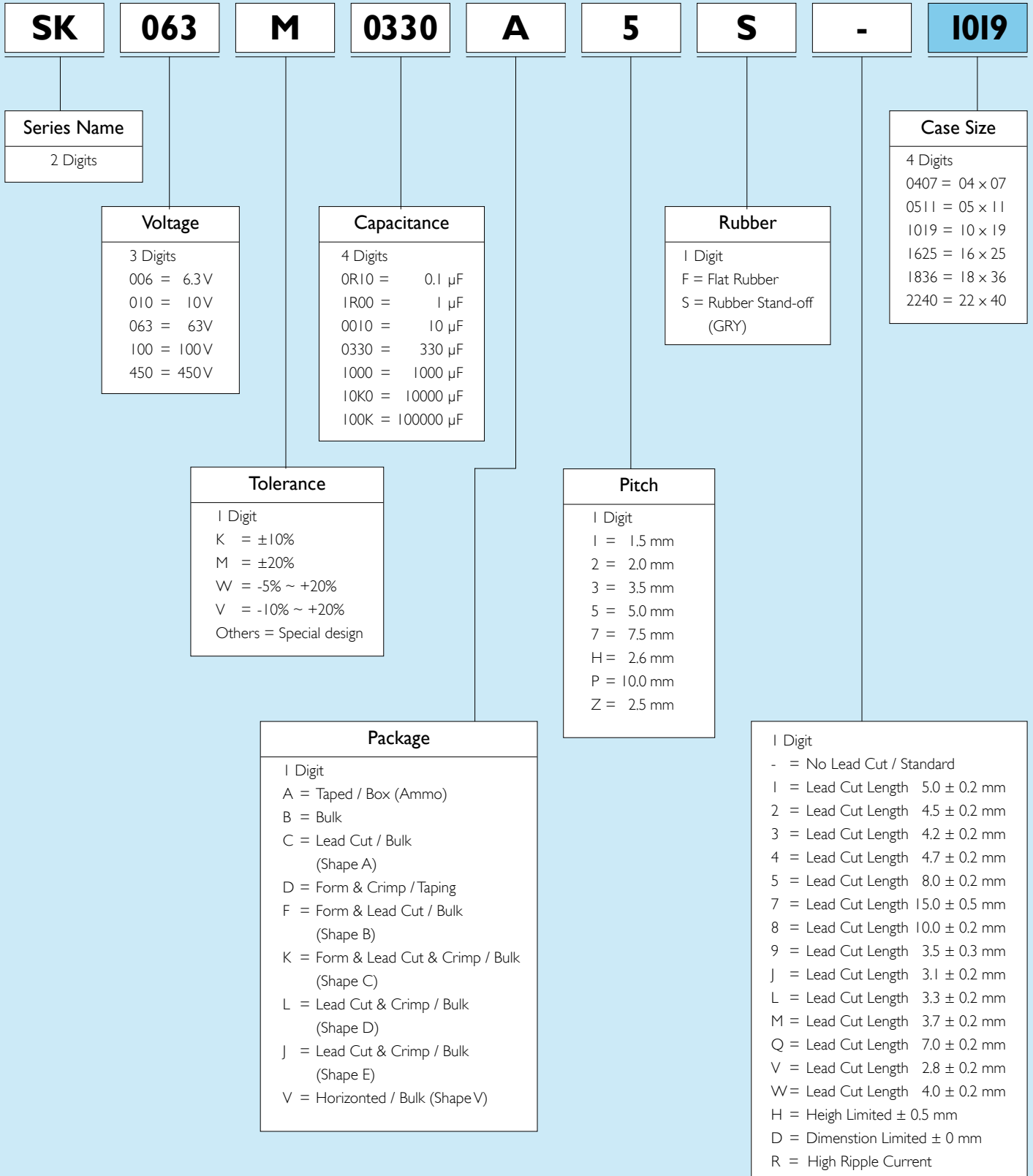

## LARGE CAN ORDERING CODE

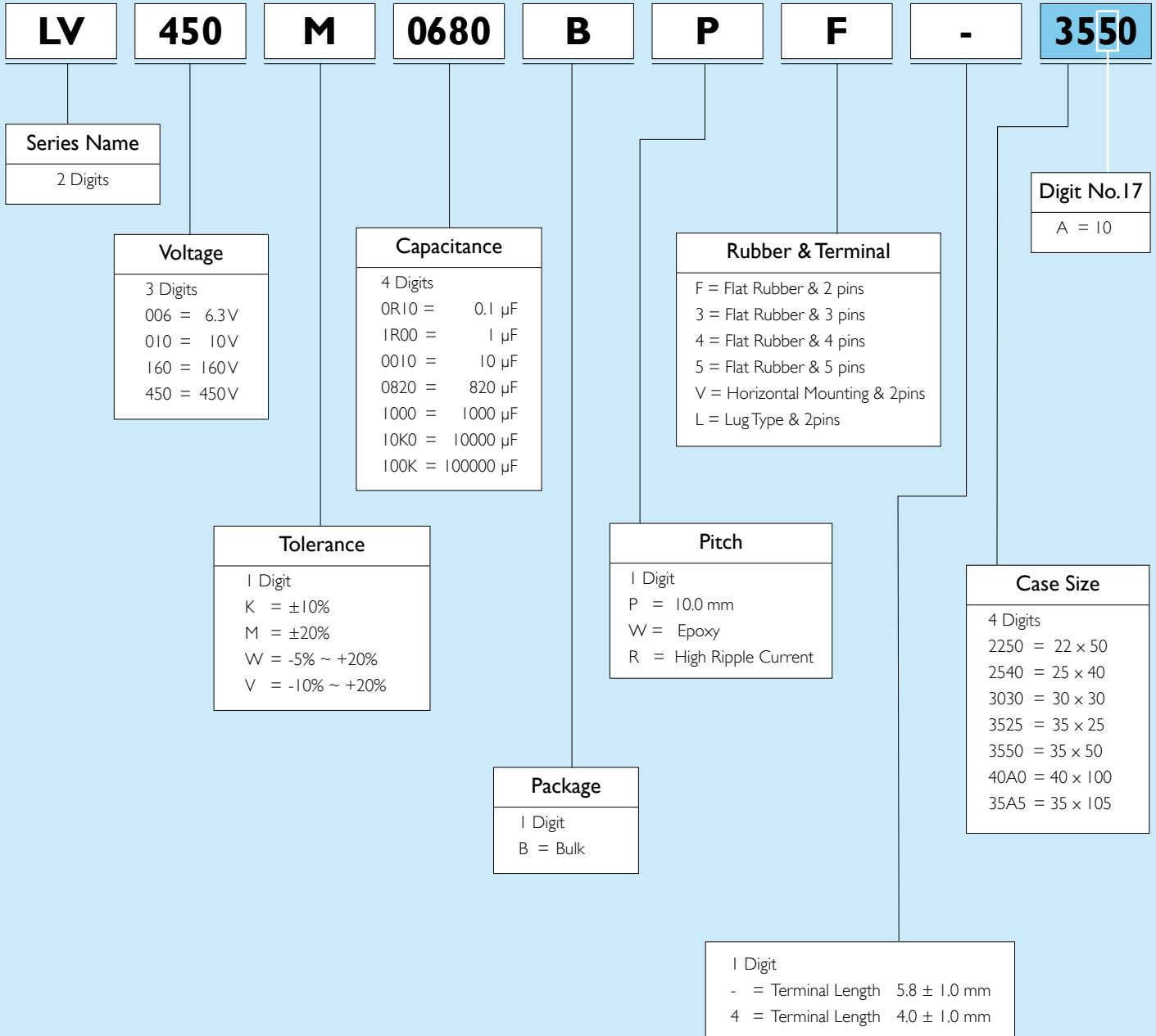

## SURFACE MOUNT ORDERING CODE

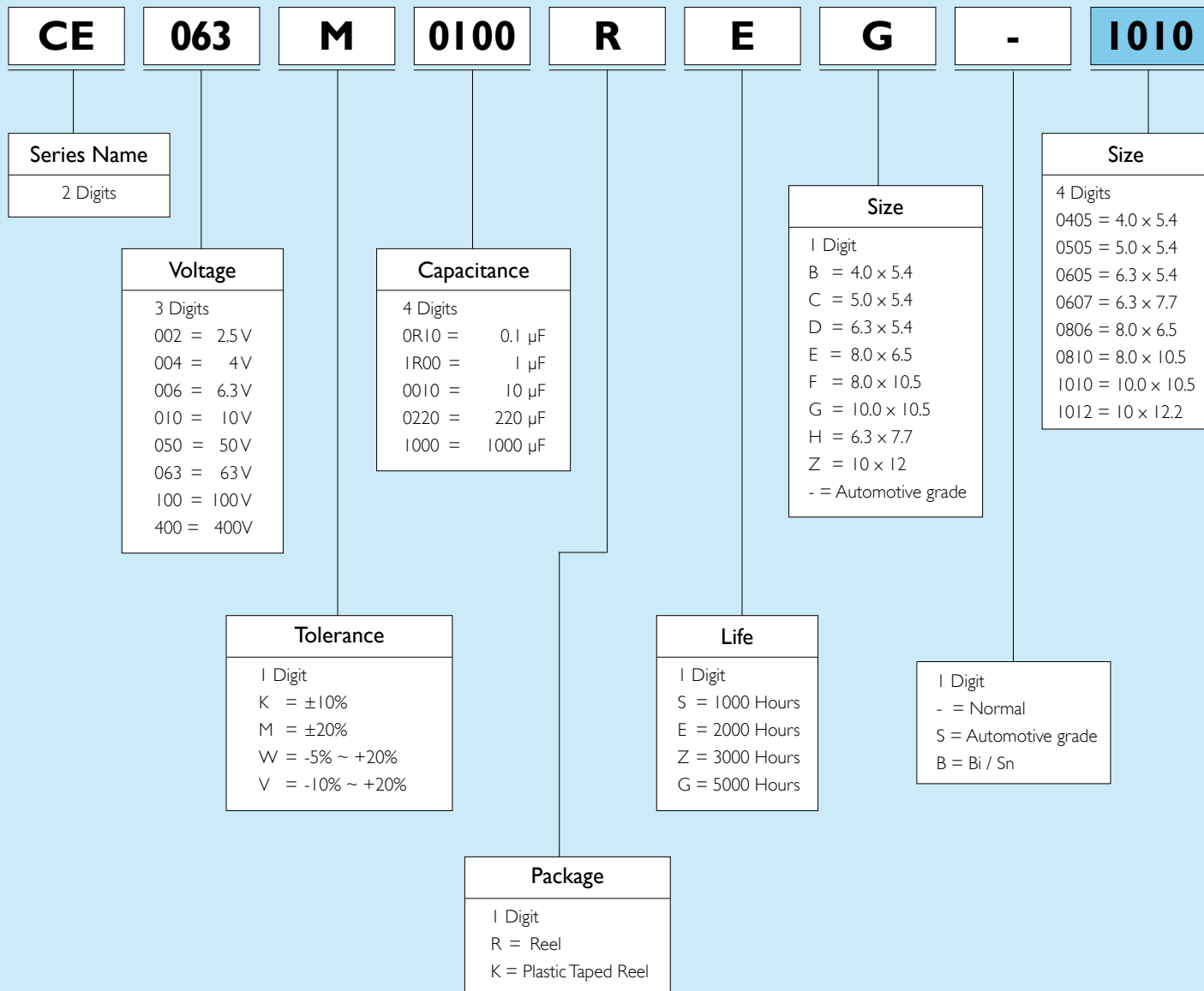

## SCREW TYPE ORDERING CODE

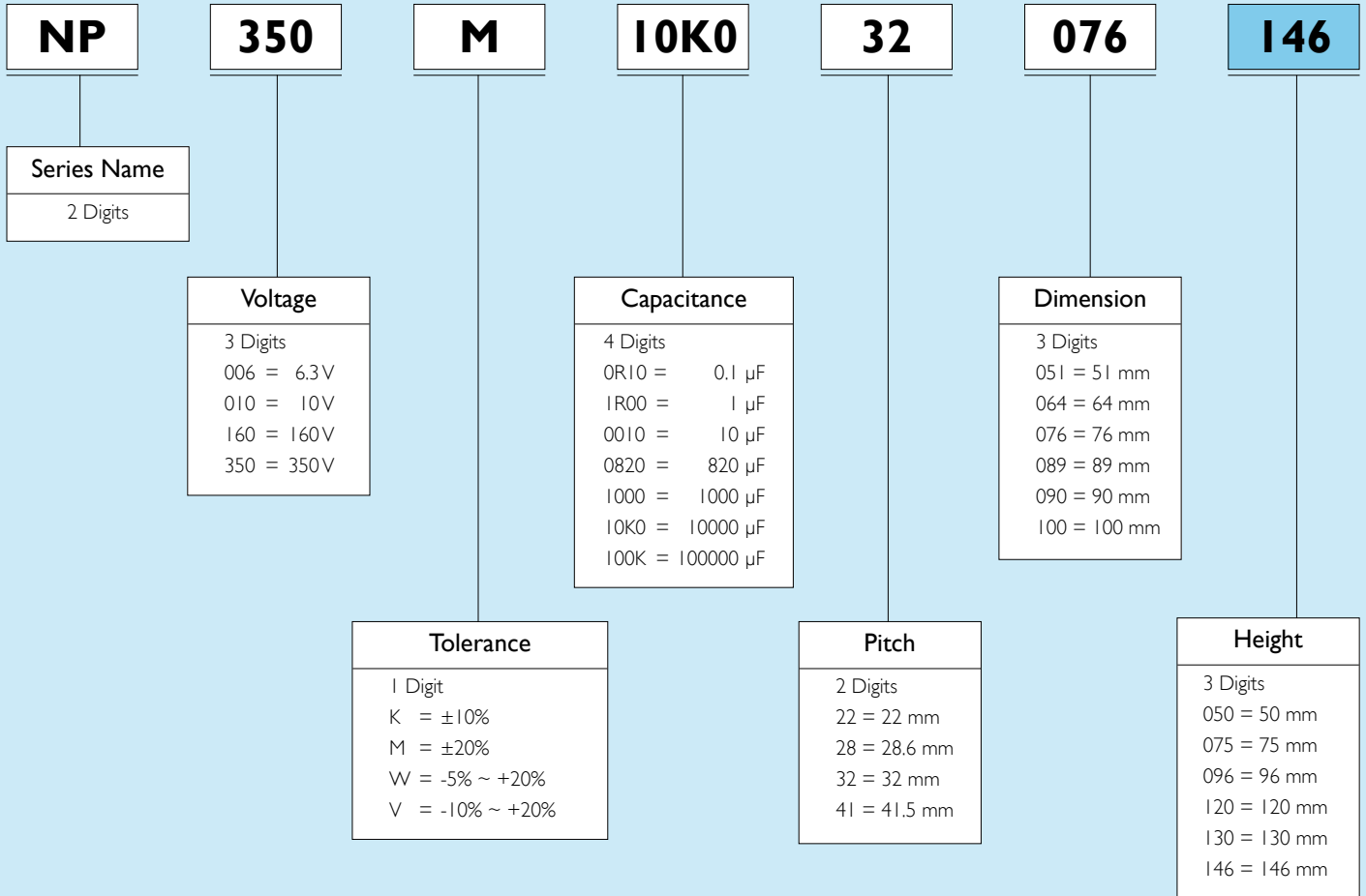

## PACKAGE INFORMATION

D × L: mm

RADIAL TYPE	BULK			TAPING		LEAD CUTTING		
	BAG/PCS	INNER BOX	CARTON	INNER BOX	CARTON	BAG/PCS	INNER BOX	CARTON
04 × 05	1000	10,000	20,000	2,500	25,000	1000	15,000	30,000
05 × 05	1000	10,000	20,000	2,000	20,000	1000	15,000	30,000
06 × 05	1000	10,000	20,000	2,000	20,000	1000	15,000	30,000
04 × 07	1000	10,000	20,000	2,500	25,000	1000	15,000	30,000
05 × 07	1000	10,000	20,000	2,000	20,000	1000	15,000	30,000
06 × 07	1000	10,000	20,000	2,000	20,000	1000	15,000	30,000
05 × 11	500	10,000	20,000	2,000	20,000	500	15,000	30,000
06 × 11	500	10,000	20,000	2,000	20,000	500	15,000	30,000
08 × 11	500	6,000	12,000	1,000	10,000	500	8,000	16,000
08 × 15	500	5,000	10,000	1,000	10,000	500	5,000	10,000
08 × 20	200	4,000	8,000	1,000	10,000	200	4,000	8,000
10 × 12	200	4,000	8,000	700	7,000	200	4,000	8,000
10 × 15	200	3,000	6,000	700	7,000	200	4,000	8,000
10 × 16	200	3,000	6,000	700	7,000	200	4,000	8,000
10 × 19	200	2,400	4,800	700	7,000	200	3,000	6,000
10 × 25	200	2,400	4,800	700	7,000	200	2,400	4,800
10 × 27	200	2,000	4,000			200	2,000	4,000
10 × 30	200	2,000	4,000			200	2,000	4,000
12 × 20	200	2,000	4,000	500	5,000	200	2,000	4,000
12 × 25	200	1,800	3,600	500	5,000	200	1,800	3,600
12 × 30	200	1,200	2,400			200	1,600	3,200
12 × 35	200	1,000	2,000				500	3,000
12 × 40	200	1,000	2,000				500	3,000
13 × 20	200	1,800	3,600	500	5,000	200	1,800	3,600
13 × 25	200	1,400	2,800	500	5,000	200	1,400	2,800
13 × 30	200	1,200	2,400				500	3,000
13 × 40	200	1,000	2,000				500	3,000
16 × 25	200	1,000	2,000	300	3,000		500	4,000
16 × 32	200	1,000	1,600				500	3,000
16 × 36	200	600	1,200				500	3,000
16 × 40	200	600	1,200				500	3,000
18 × 20	200	800	1,600			200	1,000	2,000
18 × 25	200	800	1,600				500	2,000
18 × 32	100	500	1,000				500	2,000
18 × 36	100	500	1,000				500	2,000
18 × 40	100	300	1,000				500	2,000
22 × 40	100	300	600				400	800

SNAP-IN TYPE	INNER BOX	CARTON
22 × 25 ~ 45	400	800
25 × 25 ~ 50	200	800
30 × 25 ~ 35	200	800
30 × 40 ~ 50	200	800
35 × 30 ~ 50	200	800

SMD TYPE	REEL	CARTON
4 × 5	2,000	20,000
5 × 5	1,000	10,000
6 × 5	1,000	10,000
6 × 7	1,000	10,000
8 × 6	1,000	10,000
8 × 10	500	3,000
10 × 10	500	3,000

# DIAGRAM OF TAPING DIMENSIONS

Unit: mm

Fig. 1

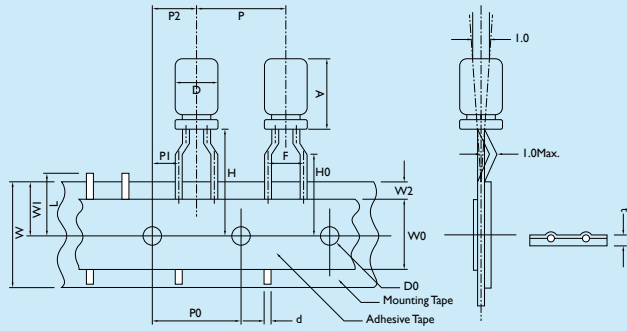

Fig. 4

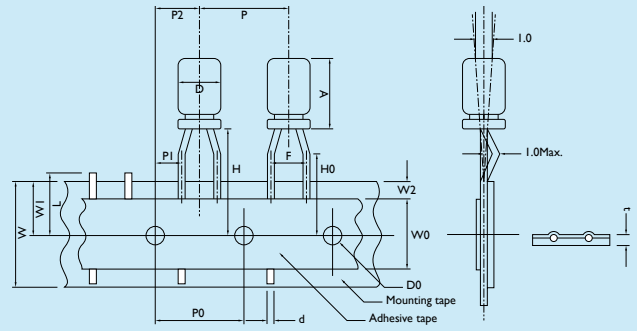

Fig. 2

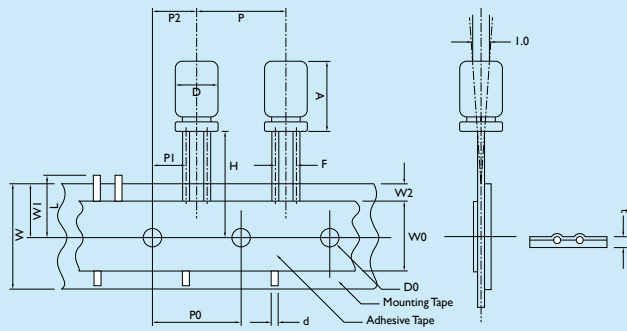

Fig. 5

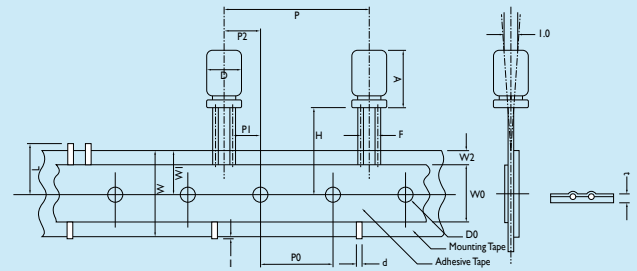

Fig. 3

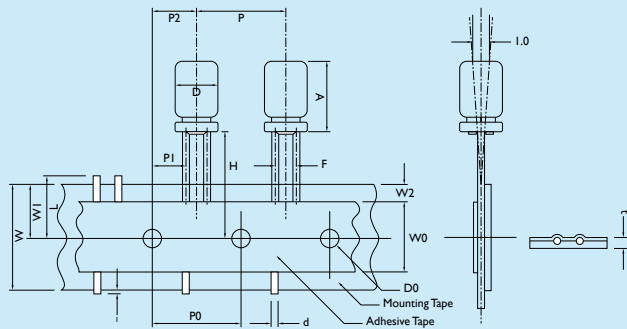
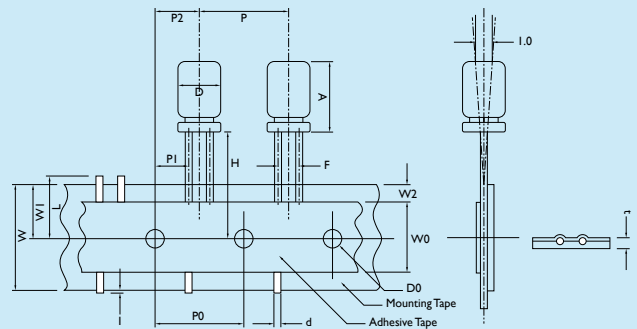

Fig. 6



## SPECIFICATIONS INFORMATION

Unit: mm

ITEM	TOLERANCE	PH = 2.5		FORMED LEAD TYPE							STRAIGHT LEAD TYPE									
		L		L							L									
		5~7	≤7 >7	5~7	≤7 >7	≤7 >7	≤7 >7	≤7 >7	5~7	≤7 >7	≤7 >7	≤7 >7	≤7 >7	≤7 >7	12~25	15~25	15~25			
D	+0.5,-0	4ø	5ø	4ø	5ø	6ø	8ø		4ø	5ø	6ø	8ø	10ø	12ø	12.5ø	13ø	16ø	18ø		
A	Max.	8.0	13	8.0	13	8.0	13	8.0	22.0	8.0	13	8.0	13	8.0	22.0	27.0				
d	±0.05	0.45	0.5	0.45	0.5	0.5	0.5	0.5	0.5	0.45	0.5	0.5	0.5	0.5	0.5	0.6		0.8		
P	±1.0	12.7		12.7						12.7							15.0	30.0		
P0	±0.3	12.7		12.7						12.7							15.0			
PI	±0.7	5.1		3.85						5.6	5.35	5.1	4.6	5.0				3.75		
P2	±1.3	6.35		6.35						6.35						7.5				
F	+0.6,-0.2	2.5		5.0						1.5	2.0	2.5	3.5	5.0				7.5 ± 0.8		
W	+1.0,-0.5	18.0		18.0						18.0										
W0	±0.5	12.0		12.0						12.0										
W1	±0.5	9.0		9.0						9.0										
W2	Max.	3.0		3.0						3.0										
H	±0.75	18.5		18.5						18.5										
H0	±0.5	16.0		16.0						-										
I	Max.	-		-						-				1.0						
D0	±0.2	4.0		4.0						4.0										
t	±0.2	0.7		0.7						0.7										
L	Max.	11.0		11.0						11.0										
<b>Fig.</b>		<b>4</b>		<b>1</b>						<b>2</b>				<b>3,6</b>			<b>5</b>			

## DIAGRAM OF LEAD CUTTING AND FORMING

Unit: mm

Shape (A)

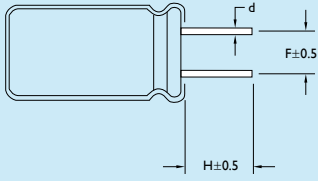

Shape (B)

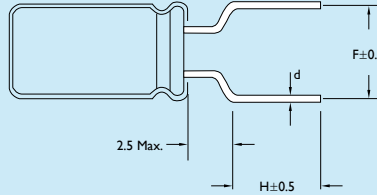

Shape (C)

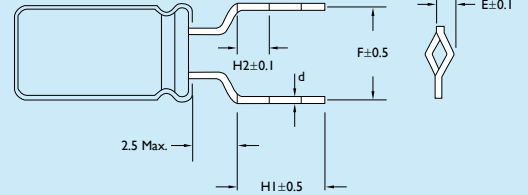

Shape (D)

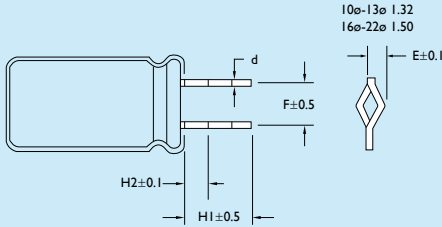

Shape (E)

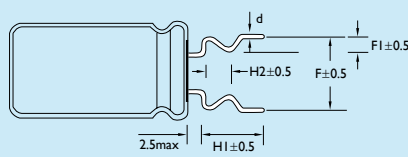

Shape (V) - Horizontal type

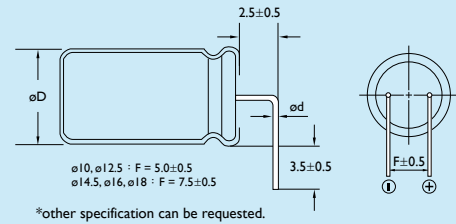

\*other specification can be requested.

## SPECIFICATIONS INFORMATION

Unit: mm

### NO. CUTTING & FORMING METHODS

		Dø	4ø	5ø	6ø	8ø	10ø	12ø	13ø	16ø	18ø	22ø			
A	Lead Cut Only	F	1.5	2.0	2.5	3.5	5.0	5.0	5.0	7.5	7.5	10			
		H	5.0	5.0	5.0	5.0	5.0	5.0	5.0	5.0	5.0	5.0			
		d	0.45	0.5	0.5	0.5	0.6	0.6	0.6	0.8	0.8	0.8			
B	Lead Cut and Form	F	5.0	5.0	5.0	5.0									
		H	5.0	5.0	5.0	5.0									
		d	0.45	0.5	0.5	0.5									
C	Lead Cut, Crimp and Form	F	5.0	5.0	5.0	5.0	5.0	5.0	5.0	5.0	5.0	5.0			
		H1	5.0	4.2	5.0	4.2	4.0	5.0	4.2	4.0	5.0	4.2	4.0		
		H2	2.5	2.0	2.5	2.0	2.0	2.5	2.0	2.0	2.5	2.0	2.0		
		d	0.45	0.5	0.5	0.5	0.5	0.5	0.5	0.5	0.5	0.5	0.5		
D	Lead Cut and Crimp	F				5.0	5.0	5.0	5.0	7.5	7.5	7.5	10		
		H1				2.5	5.0	4.2	4.0	5.0	4.2	4.0	5.0	4.2	4.0
		H2				3.5	2.5	2.0	2.0	2.5	2.0	2.0	2.5	2.0	2.0
		d				0.5	0.6	0.6	0.6	0.8	0.8	0.8			
E	Lead Cut Form and Crimp	F	5.0	5.0	5.0	5.0									
		F1	1.2	1.2	1.2	1.2									
		H1	4.0	4.0	4.0	4.0									
		d	0.45	0.5	0.5	0.5									
V	Horizontal	F					5.0	5.0	5.0	7.5	7.5				
		H					5.0	5.0	5.0	5.0	5.0				
		d					0.6	0.6	0.6	0.8	0.8				



# TERMINALS FOR SNAP-IN TYPE

Unit: mm

Standard

Apply to size  $\phi 22 \sim \phi 40$

Lug Code = L

Apply to size  $\phi 30 \sim \phi 40$

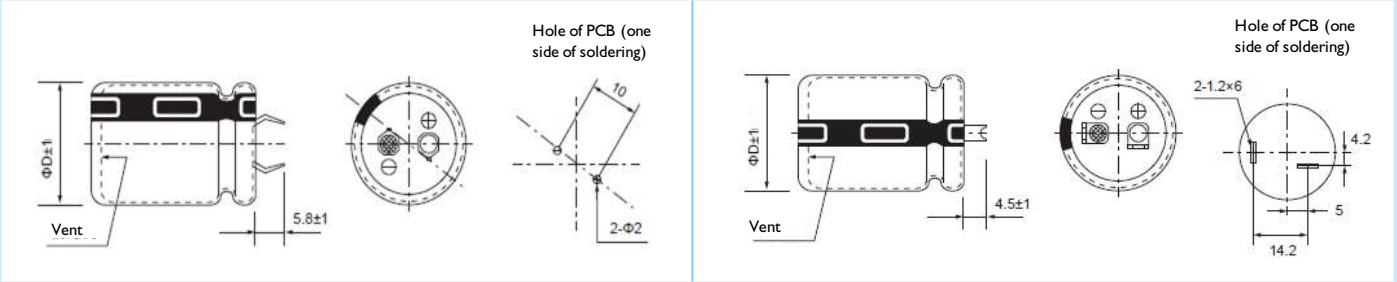

Three Terminal Code = 3

Apply to size  $\phi 30, \phi 35$

Horizontal Code = V

Apply to size  $\phi 22 \sim \phi 35$

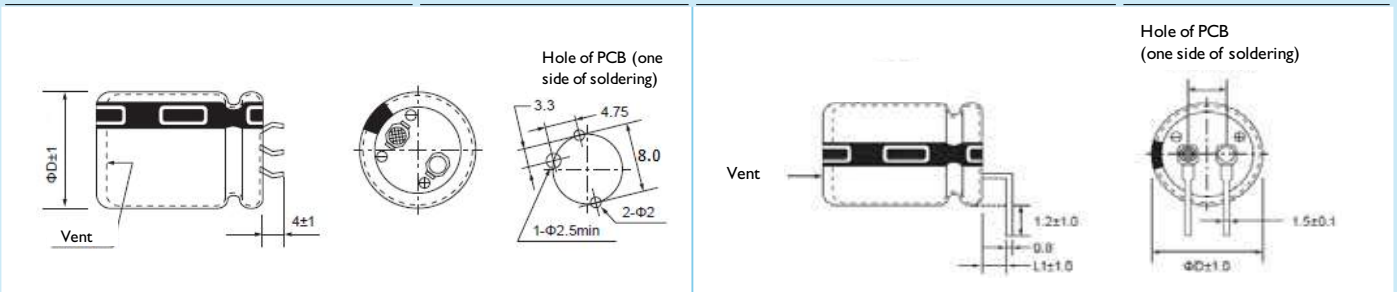

Four Terminal Code = 4

Apply to size  $\phi 35 \sim \phi 40$

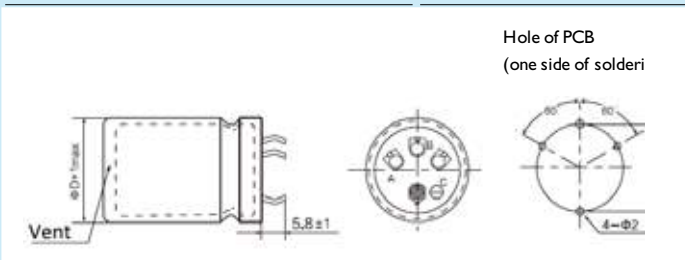

## CARRIER TAPE DIMENSION

Unit: mm

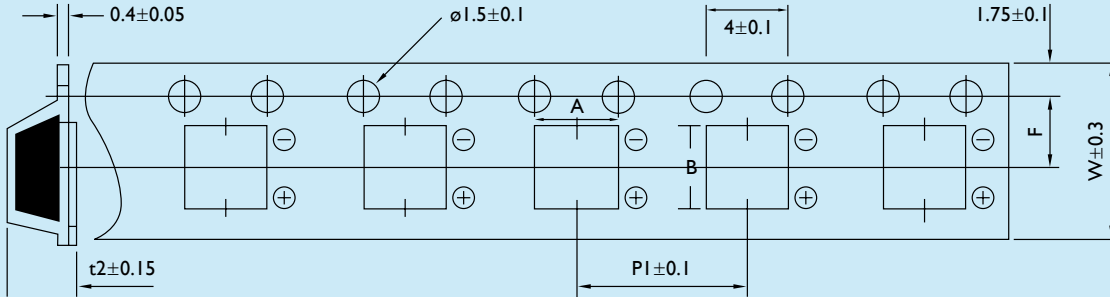

CASE SIZE	( $\phi D$ mm)	W	A	B	PI	F	t2
B	$\phi 4$	12.0	4.7	4.7	8.0	5.5	5.8
C	$\phi 5$	12.0	5.7	5.7	12.0	5.5	5.8
D	$\phi 6.3 \times 5.4$	16.0	7.0	7.0	12.0	7.5	5.8
E	$\phi 8 \times 6.5$	16.0	8.7	8.7	12.0	7.5	6.8
F	$\phi 8 \times 10.5$	24.0	8.7	8.7	16.0	11.5	11.0
G	$\phi 10 \times 10.5$	24.0	10.7	10.7	16.0	11.5	11.0
H	$\phi 6.3 \times 7.7$	16.0	7.0	7.0	12.0	7.5	8.0

## REEL DIMENSION

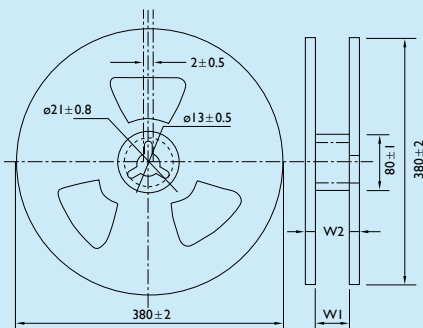

SIZE CODE	B	C	D	E	F	G	H
W1±1	14	14	18	18	26	26	18
W2±1	20	20	24	24	32	32	24

## DETAILS OF CARRIER TAPE SPECIFICATION

### (1) Details of carrier tape

- a. Last reeling empty part of carrier tape shall be more than 10 cm
- b. Leader part of seal tape shall be more than 20 cm
- c. First reeling empty part of carrier tape shall be more than 10 cm
- d. Adhesive tape fixing the end of the leader part shall be approx 10 cm

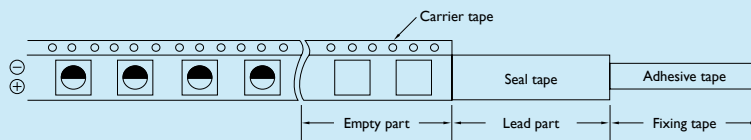

### (2) Deviation between carrier tape and seal tape

- a. Deviation between carrier tape and seal tape shall be less than 0.5 mm
- b. Seal tape shall not cover on the feeding holes more than 0.75 mm

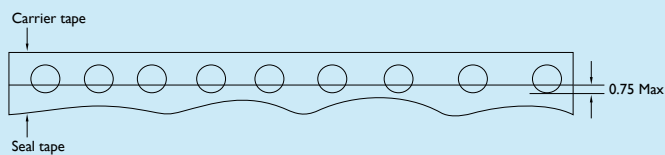
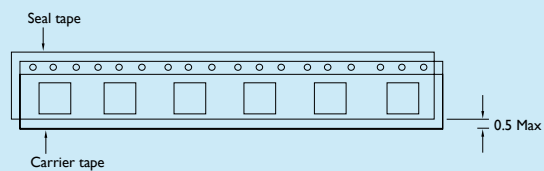

## ADHESION TEST

Reasonable pulling strength: 0.1~0.7N, Pulling speed: 300mm / min

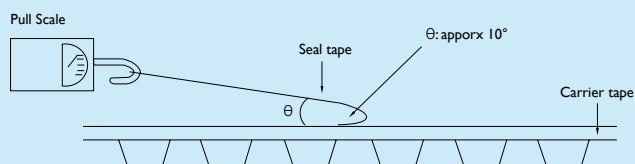

## PACKING STYLE

- (1) Carrier tape shall be reeled inside. (seal tape shall be outside)
- (2) End of the tape shall be inside to the reel physically as shown in the below figure and leader part of seal tape shall not be attached.

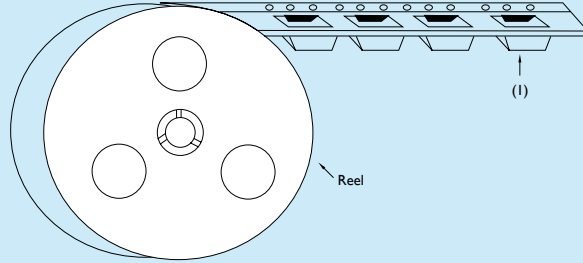

## PACKAGING QUANTITY

SIZE CODE	D x L	ONE REEL (PCS)	TOTAL QUANTITY (PCS)
B	4 x 5.4	2,000	20,000
C	5 x 5.4	1,000	10,000
D	6.3 x 5.4	1,000	10,000
E	8 x 6.5	1,000	10,000
F	8 x 10.5	500	4,000
G	10 x 10.5	500	4,000
H	6.3 x 7.7	1,000	10,000

# Surface Mount Aluminum Electrolytic

# CA [ For General ]

85°C 2000 Hours, 4-100V



## FEATURE

For General Purpose Series with 85°C 2000 Hours  
Suitable for AV (TV, Video, Audio) Monitor / Computer;  
Home appliance, OA / HA / Communication

## MARKING

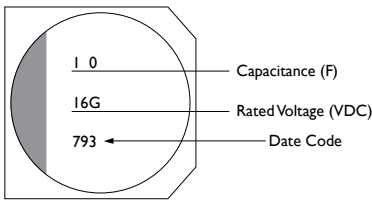

## ELECTRICAL CHARACTERISTICS

Operation Temperature Range	-40 to +85°C									
Rated Voltage Range	4 to 100VDC									
Rated Capacitance Range	0.1 ~ 1000μF									
Capacitance Tolerance	±20% at 120Hz, 20°C									
Leakage Current (Max. 20°C)	I ≤ 0.01CV (μA) or 3μA whichever is greater: (After 2 Minutes Application of DC Rated Voltage at 20°C) I = Leakage Current (μA), C = Rated Capacitance (μF), V = Rated Voltage (V)									
Low Temperature Stability	Impedance Ratio at 120Hz (Max.)									
	WV (V)	4	6.3	10	16	25	35	50	63	100
	Z (-25°C)	7	4	3	2	2	2	2	2	3
	Z (-40°C)	15	8	6	4	4	3	3	3	2
Endurance	After the rated voltage has been applied at 85°C for 2000 hours, the capacitors shall meet the following requirements. (a) Capacitance Change: Within ±20% of the Initial Value (b) Dissipation Factor: Not Exceeding 200% of Specified Value (c) Leakage Current: Not Exceeding the Specified Value									
Shelf Life	After having been placed at 85°C without voltage applied for 1000 hours, the capacitors shall meet the same requirements as Endurance.									

## DIMENSIONS

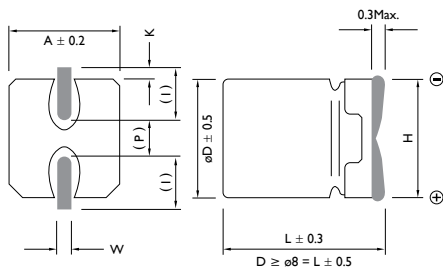

( ) Reference Size

Unit: mm

SIZE CODE	Dø	L	A	H	I	W	P	K
B	4.0	5.4	4.3	5.5 Max.	1.8	0.65 ± 0.1	1.0±0.2	0.35 <sup>+ 0.15</sup> <sub>- 0.20</sub>
C	5.0	5.4	5.3	6.5 Max.	2.2	0.65 ± 0.1	1.5±0.2	0.35 <sup>+ 0.15</sup> <sub>- 0.20</sub>
D	6.3	5.4	6.6	7.8 Max.	2.6	0.65 ± 0.1	1.8±0.2	0.35 <sup>+ 0.15</sup> <sub>- 0.20</sub>
E	8.0	6.5	8.3	9.5 Max.	3.4	0.65 ± 0.1	2.2±0.2	0.35 <sup>+ 0.15</sup> <sub>- 0.20</sub>
F	8.0	10.5	8.3	10.0 Max.	3.4	0.90 ± 0.2	3.1±0.2	0.70 ± 0.20
G	10.0	10.5	10.3	12.0 Max.	3.5	0.90 ± 0.2	4.6±0.2	0.70 ± 0.20
H	6.3	7.7	6.6	7.8 Max.	2.6	0.65 ± 0.1	1.8±0.2	0.35 <sup>+ 0.15</sup> <sub>- 0.20</sub>

## CASE SIZE & PERMISSIBLE RIPPLE CURRENT OF STANDARD PRODUCTS

D × L: mm

### CAP. RATED VOLTAGE WV (SURGE VOLTAGE WV)

(μF)	4 (5)			6.3 (8)			10 (13)			16 (20)		
	SIZE	RIPPLE CURRENT	DISSIPATION FACTOR	SIZE	RIPPLE CURRENT	DISSIPATION FACTOR	SIZE	RIPPLE CURRENT	DISSIPATION FACTOR	SIZE	RIPPLE CURRENT	DISSIPATION FACTOR
4.7										4 × 5.4	20	0.16
10							4 × 5.4	14	0.30	4 × 5.4	28	0.16
22	4 × 5.4	19	0.35	4 × 5.4	20	0.26	4 × 5.4	28	0.30	4 × 5.4	27	0.26
										5 × 5.4	39	0.16
33	4 × 5.4	26	0.35	5 × 5.4	22	0.26	4 × 5.4	29	0.30	5 × 5.4	45	0.26
							5 × 5.4	43	0.20	6.3 × 5.4	66	0.16
47	4 × 5.4	34	0.35	4 × 5.4	38	0.26	5 × 5.4	43	0.30	6.3 × 5.4	70	0.16
				5 × 5.4	46	0.26	6.3 × 5.4	46	0.30	6.3 × 7.7	75	0.18
100	5 × 5.4	61	0.35	6.3 × 5.4	71	0.26	5 × 5.4	60	0.30	6.3 × 5.4	70	0.20
							6.3 × 5.4	70	0.26	6.3 × 7.7	85	0.20
										8 × 6.5	86	0.20
220	6.3 × 5.4	82	0.35	6.3 × 5.4	190	0.26	6.3 × 7.7	105	0.26	6.3 × 7.7	105	0.20
				6.3 × 7.7	235	0.35	8 × 6.5	250	0.26	8 × 10.5	280	0.20
				8 × 6.5	250	0.35						
330				6.3 × 7.7	280	0.35	8 × 10.5	330	0.26	8 × 10.5	316	0.20
				8 × 6.5	300	0.35				10 × 10.5	380	0.20
				8 × 10.5	340	0.35						
470				8 × 10.5	380	0.35	8 × 10.5	330	0.26	8 × 10.5	350	0.20
							10 × 10.5	400	0.26	10 × 10.5	420	0.20
1000				8 × 10.5	580	0.35	10 × 10.5	580	0.26			
				10 × 10.5	700	0.35						
1500				10 × 10.5	1000	0.35						

Note: 1. Ripple Current: (mA/rms) 85°C, 120Hz

2. Dissipation Factor: 20°C, 120Hz

## CASE SIZE & PERMISSIBLE RIPPLE CURRENT OF STANDARD PRODUCTS

D x L: mm

CAP. (μF)	RATED VOLTAGE WV (SURGE VOLTAGE WV)								
	25 (32) SIZE			35 (44) SIZE			50 (63) SIZE		
	SIZE	RIPPLE CURRENT	DISSIPATION FACTOR	SIZE	RIPPLE CURRENT	DISSIPATION FACTOR	SIZE	RIPPLE CURRENT	DISSIPATION FACTOR
0.10							4 x 5.4	1	0.12
0.22							4 x 5.4	2	0.12
0.33							4 x 5.4	3	0.12
0.47							4 x 5.4	5	0.12
1.0							4 x 5.4	10	0.12
2.2				4 x 5.4	8	0.12	4 x 5.4	16	0.12
3.3				4 x 5.4	10	0.12	4 x 5.4	16	0.12
4.7	4 x 5.4	22	0.14	4 x 5.4	22	0.12	5 x 5.4	23	0.12
10	4 x 5.4	24	0.20	4 x 5.4	24	0.16	5 x 5.4	28	0.12
	5 x 5.4	28	0.14	5 x 5.4	30	0.12	6.3 x 5.4	35	0.12
22	5 x 5.4	45	0.14	5 x 5.4	49	0.23	6.3 x 5.4	70	0.12
	6.3 x 5.4	55	0.14	6.3 x 5.4	60	0.12	6.3 x 7.7	90	0.12
33							8 x 6.5	110	0.12
	5 x 5.4	53	0.14	6.3 x 5.4	100	0.14	6.3 x 7.7	90	0.12
	6.3 x 5.4	65	0.14	8 x 6.5	130	0.14	8 x 10.5	120	0.12
47	6.3 x 5.4	70	0.20	6.3 x 7.7	150	0.14	6.3 x 7.7	63	0.12
	8 x 6.5	96	0.16	8 x 6.5	165	0.14	8 x 10.5	100	0.12
							10 x 10.5	130	0.12
100	6.3 x 7.7	115	0.16	6.3 x 7.7	140	0.14	8 x 10.5	160	0.12
	8 x 6.5	140	0.16	8 x 6.5	170	0.14	10 x 10.5	190	0.12
	8 x 10.5	180	0.16	10 x 10.5	210	0.14			
220	8 x 6.5	210	0.16	8 x 10.5	250	0.14	10 x 10.5	310	0.12
	8 x 10.5	260	0.16	10 x 10.5	310	0.14			
	10 x 10.5	310	0.16						
330	8 x 10.5	350	0.16	10 x 10.5	400	0.14			
	10 x 10.5	430	0.16						
470	10 x 10.5	480	0.16						

Note: 1. Ripple Current: (mA/rms) 85°C, 120Hz

2. Dissipation Factor: 20°C, 120Hz

## CASE SIZE & PERMISSIBLE RIPPLE CURRENT OF STANDARD PRODUCTS

D × L: mm

CAP. (μF)	RATED VOLTAGE W V (SURGE VOLTAGE W V)					
	63 (79) SIZE			100 (125) SIZE		
		RIPPLE CURRENT	DISSIPATION FACTOR		RIPPLE CURRENT	DISSIPATION FACTOR
3.3				8 × 10.5	30	0.18
4.7	6.3 × 5.4	20	0.18	8 × 10.5	50	0.18
10	6.3 × 5.4	20	0.18	8 × 10.5	55	0.18
22	8 × 10.5	30	0.18	10 × 10.5	60	0.18
33	8 × 10.5	30	0.18	10 × 10.5	65	0.18
47	8 × 10.5	30	0.18			
100	10 × 10.5	60	0.18			

Note: 1. Ripple Current: (mA/rms) 85°C, 120Hz

2. Dissipation Factor: 20°C, 120Hz



# Surface Mount Aluminum Electrolytic

# CB [ For General ]

105°C 1000 Hours, 4-100V



## FEATURE

For General Purposes Series with 105°C 1000 Hours  
Suitable for AV (TV, Video, Audio) Monitor / Computer,  
OA / HA / Communication

## MARKING

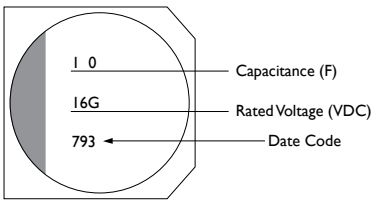

## ELECTRICAL CHARACTERISTICS

Operation Temperature Range	-40 to +105°C									
Rated Voltage Range	4 to 100VDC									
Rated Capacitance Range	0.1 ~ 1000μF									
Capacitance Tolerance	±20% at 120Hz, 20°C									
Leakage Current (Max. 20°C)	I ≤ 0.01 CV (μA) or 3μA Whichever is greater. (After 2 Minutes Application of DC Rated Working Voltage at 20°C)									
Low Temperature Stability	Impedance Ratio at 120Hz									
	WV (V)	4	6.3	10	16	25	35	50	63	100
	Z (-25°C) / Z (+20°C)	7	4	3	2	2	2	2	2	2
	Z (-40°C) / Z (+20°C)	15	8	6	4	4	3	3	3	3
Endurance	After 1000 hours application of WV at 105°C, the capacitors shall meet following requirements. (a) Capacitance Change: Within ±20% of the Initial Value (b) Dissipation Factor: Not Exceeding 200% of Specified Value (c) Leakage Current: Not Exceeding the Specified Value									
Shelf Life	After having been placed at 105°C without voltage applied for 1000 hours, the capacitors shall meet the same requirements as Endurance.									

## DIMENSIONS

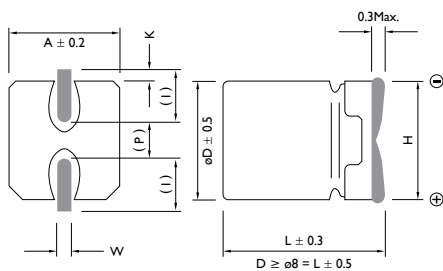

( ) Reference Size

Unit: mm

SIZE CODE	Dø	L	A	H	I	W	P	K
B	4.0	5.4	4.3	5.5 Max.	1.8	0.65 ± 0.1	1.0 ± 0.2	0.35 <sup>+ 0.15</sup> <sub>- 0.20</sub>
C	5.0	5.4	5.3	6.5 Max.	2.2	0.65 ± 0.1	1.5 ± 0.2	0.35 <sup>+ 0.15</sup> <sub>- 0.20</sub>
D	6.3	5.4	6.6	7.8 Max.	2.6	0.65 ± 0.1	1.8 ± 0.2	0.35 <sup>+ 0.15</sup> <sub>- 0.20</sub>
E	8.0	6.5	8.3	9.5 Max.	3.4	0.65 ± 0.1	2.2 ± 0.2	0.35 <sup>+ 0.15</sup> <sub>- 0.20</sub>
F	8.0	10.5	8.3	10.0 Max.	3.4	0.90 ± 0.2	3.1 ± 0.2	0.70 ± 0.20
G	10.0	10.5	10.3	12.0 Max.	3.5	0.90 ± 0.2	4.6 ± 0.2	0.70 ± 0.20
H	6.3	7.7	6.6	7.8 Max.	2.6	0.65 ± 0.1	1.8 ± 0.2	0.35 <sup>+ 0.15</sup> <sub>- 0.20</sub>

## CASE SIZE & PERMISSIBLE RIPPLE CURRENT OF STANDARD PRODUCTS

D x L: mm

### CAP. RATED VOLTAGE WV (SURGE VOLTAGE WV)

(μF)	4 (5)			6.3 (8)			10 (13)			16 (20)		
	SIZE	RIPPLE CURRENT	DISSIPATION FACTOR	SIZE	RIPPLE CURRENT	DISSIPATION FACTOR	SIZE	RIPPLE CURRENT	DISSIPATION FACTOR	SIZE	RIPPLE CURRENT	DISSIPATION FACTOR
4.7										4 x 5.4	20	0.16
10							4 x 5.4	24	0.30	4 x 5.4	28	0.16
22	4 x 5.4	20	0.35	4 x 5.4	29	0.30	4 x 5.4	36	0.30	5 x 5.4	39	0.16
33	4 x 5.4	26	0.35	4 x 5.4	43	0.30	4 x 5.4	45	0.30	6.3 x 5.4	65	0.20
47	4 x 5.4	34	0.35	5 x 5.4	46	0.30	5 x 5.4	55	0.30	6.3 x 5.4	70	0.20
							6.3 x 5.4	70	0.30	6.3 x 7.7	125	0.20
100	5 x 5.4	61	0.35	5 x 5.4	58	0.35	8 x 6.5	110	0.30	6.3 x 5.4	100	0.20
				6.3 x 5.4	71	0.35			6.3 x 7.7	98	0.20	
								8 x 6.5	130	0.20		
220	6.3 x 5.4	82	0.35	6.3 x 5.4	95	0.35	6.3 x 7.7	115	0.30	6.3 x 7.7	100	0.20
				6.3 x 7.7	120	0.35	8 x 10.5	160	0.26	10 x 10.5	210	0.20
				8 x 6.5	130	0.35						
330				6.3 x 7.7	175	0.35	10 x 10.5	230	0.26	10 x 10.5	230	0.20
				8 x 10.5	230	0.35						
470				10 x 10.5	260	0.35	10 x 10.5	270	0.26	8 x 10.5	230	0.20
				10 x 10.5	275	0.20						
1000				10 x 10.5	380	0.35	10 x 10.5	390	0.26			

Note: 1. Ripple Current: (mA/rms) 105°C, 120Hz

2. Dissipation Factor: 20°C, 120Hz

## CASE SIZE & PERMISSIBLE RIPPLE CURRENT OF STANDARD PRODUCTS

D x L: mm

CAP. (μF)	RATED VOLTAGE WV (SURGE VOLTAGE WV)								
	25 (32)			35 (44)			50 (63)		
	SIZE	RIPPLE CURRENT	DISSIPATION FACTOR	SIZE	RIPPLE CURRENT	DISSIPATION FACTOR	SIZE	RIPPLE CURRENT	DISSIPATION FACTOR
0.10							4 × 5.4	1	0.12
0.22							4 × 5.4	2	0.12
0.33							4 × 5.4	3	0.12
0.47							4 × 5.4	5	0.12
1.0							4 × 5.4	10	0.12
2.2				4 × 5.4	15	0.12	4 × 5.4	16	0.12
3.3				4 × 5.4	18	0.12	4 × 5.4	16	0.12
4.7	4 × 5.4	22	0.14	4 × 5.4	22	0.12	5 × 5.4	23	0.12
10	4 × 5.4	23	0.14	5 × 5.4	30	0.12	6.3 × 5.4	35	0.12
	5 × 5.4	28	0.14						
22	5 × 5.4	45	0.14	6.3 × 5.4	60	0.14	6.3 × 7.7	65	0.12
	6.3 × 5.4	55	0.14				8 × 6.5	70	0.12
33	6.3 × 5.4	65	0.16	8 × 6.5	84	0.14	6.3 × 7.7	70	0.12
							8 × 10.5	91	0.12
47	6.3 × 5.4	65	0.16	6.3 × 7.7	72	0.14	6.3 × 7.7	65	0.12
	8 × 6.5	91	0.16	8 × 6.5	76	0.14	10 × 10.5	100	0.12
				8 × 10.5	98	0.14			
100	6.3 × 7.7	95	0.16	6.3 × 7.7	105	0.14	8 × 10.5	120	0.12
	8 × 6.5	100	0.16	8 × 10.5	130	0.14	10 × 10.5	145	0.12
	8 × 10.5	130	0.16	10 × 10.5	160	0.14			
220	8 × 10.5	220	0.16	10 × 10.5	240	0.14			
	10 × 10.5	273	0.16						
330									
470	10 × 10.5	570	0.16						

Note: 1. Ripple Current: (mA/rms) 105°C, 120Hz

2. Dissipation Factor: 20°C, 120Hz

## CASE SIZE & PERMISSIBLE RIPPLE CURRENT OF STANDARD PRODUCTS

D x L: mm

CAP. (μF)	RATED VOLTAGE WV (SURGE VOLTAGE WV)					
	63 (79) SIZE			100 (125) SIZE		
		RIPPLE CURRENT	DISSIPATION FACTOR		RIPPLE CURRENT	DISSIPATION FACTOR
3.3				8 × 10.5	30	0.18
4.7	6.3 × 5.4	20	0.18	8 × 10.5	50	0.18
10	6.3 × 5.4	20	0.18	8 × 10.5	55	0.18
22	8 × 10.5	30	0.18	10 × 10.5	60	0.18
33	8 × 10.5	30	0.18	10 × 10.5	65	0.18
47	8 × 10.5	30	0.18			
100	10 × 10.5	60	0.18			

Note: 1. Ripple Current: (mA/rms) 105°C, 120Hz

2. Dissipation Factor: 20°C, 120Hz

# Surface Mount Aluminum Electrolytic

# CE [ Long Life ]

105°C 2000 Hours, 6.3-400V



## FEATURE

For Long Life Series with 105°C 2000 Hours

Suitable for AV (TV, Video, Audio), Monitor / Computer, OA / HA / Communication

## MARKING

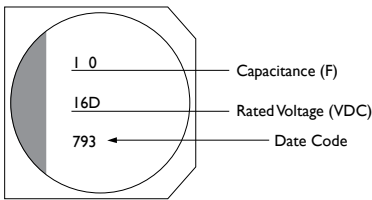

## DIMENSIONS

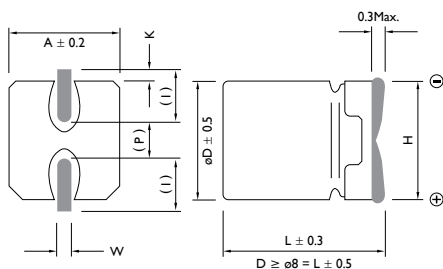

( ) Reference Size

## ELECTRICAL CHARACTERISTICS

Operation Temperature Range	-40 to +105°C																											
Rated Voltage Range	6.3 to 100VDC / 160 ~ 450V																											
Rated Capacitance Range	0.1 ~ 1000 $\mu$ F																											
Capacitance Tolerance	$\pm 20\%$ at 120Hz, 20°C																											
Leakage Current (Max. 20°C)	$I \leq 0.01CV$ ( $\mu$ A) or $3\mu$ A whichever is greater. (After Rated Voltage Applied for 2 Minutes) $I$ = Leakage Current ( $\mu$ A), $C$ = Rated Capacitance ( $\mu$ F), $V$ = Rated Voltage (V)																											
Low Temperature Stability	Impedance Ratio at 120Hz <table border="1"> <tr> <td>WV (V)</td> <td>6.3</td> <td>10</td> <td>16</td> <td>25</td> <td>35</td> <td>50</td> <td>63</td> <td>100</td> </tr> <tr> <td>Z (-25°C) / Z (+20°C)</td> <td>4</td> <td>3</td> <td>2</td> <td>2</td> <td>2</td> <td>2</td> <td>2</td> <td>2</td> </tr> <tr> <td>Z (-40°C) / Z (+20°C)</td> <td>8</td> <td>6</td> <td>4</td> <td>4</td> <td>3</td> <td>3</td> <td>3</td> <td>3</td> </tr> </table>	WV (V)	6.3	10	16	25	35	50	63	100	Z (-25°C) / Z (+20°C)	4	3	2	2	2	2	2	2	Z (-40°C) / Z (+20°C)	8	6	4	4	3	3	3	3
WV (V)	6.3	10	16	25	35	50	63	100																				
Z (-25°C) / Z (+20°C)	4	3	2	2	2	2	2	2																				
Z (-40°C) / Z (+20°C)	8	6	4	4	3	3	3	3																				
Endurance	After the WV has been applied at 105°C for 2000 hours, the capacitors shall meet following requirements. (a) Capacitance Change: Within $\pm 25\%$ of the Initial Value for 4 $\varnothing$ to 6.3 $\varnothing$ Within $\pm 20\%$ of the Initial Value for 8 $\varnothing$ to 10 $\varnothing$ (b) Dissipation Factor: Not Exceeding 200% of Specified Value (c) Leakage Current: Not Exceeding the Specified Value																											
Shelf Life	After having been placed at 105°C without voltage applied for 1000 hours, the capacitors shall meet the same requirements as Endurance.																											

Unit: mm

SIZE CODE	D $\varnothing$	L	A	H	I	W	P	K
B	4.0	5.4	4.3	5.5 Max.	1.8	0.65 $\pm$ 0.1	1.0 $\pm$ 0.2	0.35 $\begin{matrix} +0.15 \\ -0.20 \end{matrix}$
C	5.0	5.4	5.3	6.5 Max.	2.2	0.65 $\pm$ 0.1	1.5 $\pm$ 0.2	0.35 $\begin{matrix} +0.15 \\ -0.20 \end{matrix}$
D	6.3	5.4	6.6	7.8 Max.	2.6	0.65 $\pm$ 0.1	1.8 $\pm$ 0.2	0.35 $\begin{matrix} +0.15 \\ -0.20 \end{matrix}$
E	8.0	6.5	8.3	9.5 Max.	3.4	0.65 $\pm$ 0.1	2.2 $\pm$ 0.2	0.35 $\begin{matrix} +0.15 \\ -0.20 \end{matrix}$
F	8.0	10.5	8.3	10.0 Max.	3.4	0.90 $\pm$ 0.2	3.1 $\pm$ 0.2	0.70 $\pm$ 0.20
G	10.0	10.5	10.3	12.0 Max.	3.5	0.90 $\pm$ 0.2	4.6 $\pm$ 0.2	0.70 $\pm$ 0.20
H	6.3	7.7	6.6	7.8 Max.	2.6	0.65 $\pm$ 0.1	1.8 $\pm$ 0.2	0.35 $\begin{matrix} +0.15 \\ -0.20 \end{matrix}$
Z	10.0	12.5	10.3	12.0 Max.	3.5	0.90 $\pm$ 0.2		

## CASE SIZE & PERMISSIBLE RIPPLE CURRENT OF STANDARD PRODUCTS

D × L: mm

CAP. (μF)	RATED VOLTAGE WV (SURGE VOLTAGE WV)								
	6.3 (8) SIZE			10 (13) SIZE			16 (20) SIZE		
		RIPPLE CURRENT	DISSIPATION FACTOR		RIPPLE CURRENT	DISSIPATION FACTOR		RIPPLE CURRENT	DISSIPATION FACTOR
4.7							4 × 5.4	20	0.16
10							4 × 5.4	28	0.16
22	5 × 5.4	29	0.30	5 × 5.4	36	0.22	5 × 5.4	39	0.16
33	5 × 5.4	43	0.30	5 × 5.4	45	0.22	6.3 × 5.4	65	0.16
47	5 × 5.4	44	0.30	6.3 × 5.4	70	0.22	6.3 × 5.4	70	0.16
	6.3 × 5.4	46	0.30				6.3 × 7.7	80	0.16
100	6.3 × 5.4	71	0.30	6.3 × 5.4	85	0.30	6.3 × 5.4	100	0.20
				6.3 × 7.7	104	0.30	6.3 × 7.7	130	0.20
				8 × 6.5	110	0.30	8 × 10.5	140	0.20
220	6.3 × 7.7	115	0.35	6.3 × 7.7	105	0.30	10 × 10.5	210	0.20
	8 × 10.5	150	0.35	8 × 10.5	160	0.30			
330	8 × 10.5	230	0.35	8 × 10.5	190	0.30	10 × 10.5	230	0.20
				10 × 10.5	230	0.26			
470	8 × 10.5	260	0.35	10 × 10.5	270	0.26	10 × 10.5	275	0.20
	10 × 10.5	260	0.35						
1000	10 × 10.5	380	0.35	10 × 10.5	390	0.26			

Note: 1. Ripple Current: (mA/rms) 105°C, 120Hz

2. Dissipation Factor: 20°C, 120Hz

## CASE SIZE & PERMISSIBLE RIPPLE CURRENT OF STANDARD PRODUCTS

D x L: mm

CAP. (μF)	RATED VOLTAGE WV (SURGE VOLTAGE WV)								
	25 (32)			35 (44)			50 (63)		
	SIZE	RIPPLE CURRENT	DISSIPATION FACTOR	SIZE	RIPPLE CURRENT	DISSIPATION FACTOR	SIZE	RIPPLE CURRENT	DISSIPATION FACTOR
0.10							4 x 5.4	1	0.12
0.22							4 x 5.4	2	0.12
0.33							4 x 5.4	3	0.12
0.47							4 x 5.4	5	0.12
1.0							4 x 5.4	10	0.12
2.2							4 x 5.4	16	0.12
3.3							4 x 5.4	16	0.12
4.7	4 x 5.4	22	0.14	5 x 5.4	23	0.12	4 x 5.4	18	0.12
							5 x 5.4	23	0.12
6.8	4 x 5.4	25	0.14	5 x 5.4	27	0.12	5 x 5.4	30	0.12
10	5 x 5.4	28	0.14	5 x 5.4	30	0.12	5 x 5.4	35	0.12
22	6.3 x 5.4	55	0.14	6.3 x 5.4	60	0.14	8 x 10.5	70	0.12
33	6.3 x 5.4	65	0.14	6.3 x 7.7	79	0.14	8 x 10.5	91	0.12
				8 x 6.5	84	0.14			
47	6.3 x 5.4	70	0.16	8 x 10.5	98	0.14	10 x 10.5	100	0.12
	6.3 x 7.7	86	0.16						
	8 x 6.5	91	0.16						
100	6.3 x 7.7	90	0.16	10 x 10.5	160	0.14	10 x 10.5	145	0.12
	8 x 10.5	130	0.16						
220	8 x 10.5	220	0.16	10 x 10.5	240	0.14	10 x 10.5	200	0.12
	10 x 10.5	273	0.16						
330	10 x 10.5	334	0.16						
470	10 x 10.5	300	0.16						

Note: 1. Ripple Current: (mA/rms) 105°C, 120Hz

2. Dissipation Factor: 20°C, 120Hz

## CASE SIZE & PERMISSIBLE RIPPLE CURRENT OF STANDARD PRODUCTS

D x L: mm

CAP. (μF)	RATED VOLTAGE WV (SURGE VOLTAGE WV)									
	63 (79)		100 (125)		160 (250)		250 (300)		400 (450)	
	SIZE	RIPPLE CURRENT	SIZE	RIPPLE CURRENT	SIZE	RIPPLE CURRENT	SIZE	RIPPLE CURRENT	SIZE	RIPPLE CURRENT
2.2									8 × 10.5	29
3.3			8 × 10.5	30			8 × 10.5	36	8 × 10.5	30
4.7	8 × 10.5	25	8 × 10.5	80			8 × 10.5	42	10 × 10.5	45
5.6									10 × 12.5	51
6.8							8 × 10.5	64	10 × 12.5	52
8.2							10 × 10.5	70	10 × 12.5	55
10	8 × 10.5	25	8 × 10.5	85	8 × 10.5	57	10 × 10.5	72	10 × 12.5	60
22	10 × 10.5	45	10 × 10.5	85	10 × 12.5	80				
33	10 × 10.5	45	10 × 10.5	90						
47	10 × 10.5	55								

Note: 1. Ripple Current: (mA/rms) 105°C, 120Hz

2. Dissipation Factor: 20°C, 120Hz



# Surface Mount Aluminum Electrolytic

# CZ [ Low Impedance ]

105°C 1000 Hours, 4-50V



## FEATURE

For Low ESR Series with 105°C 1000 Hours

Suitable for AV (TV, Video, Audio), Monitor / Computer, Battery Charger, DC / DC Converter, SMPS, Noise Filter

## MARKING

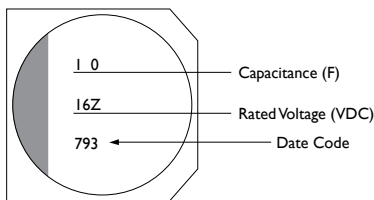

## ELECTRICAL CHARACTERISTICS

Operation Temperature Range	-40 to +105°C							
Rated Voltage Range	4 to 50VDC							
Rated Capacitance Range	0.1 ~ 1000μF							
Capacitance Tolerance	±20% at 120Hz, 20°C							
Leakage Current (Max.20°C)	$I \leq 0.01CV$ (μA) or 3μA (After 2 Minutes Application of DC Rated Voltage at 20°C) I = Leakage Current (μA), C = Rated Capacitance (μF), V = Rated Voltage (V)							
Low Temperature Stability	Impedance Ratio at 120Hz							
	WV (V)	4	6.3	10	16	25	35	50
	Z (-25°C) / Z (+20°C)	4	2	2	2	2	2	2
	Z (-40°C) / Z (+20°C)	8	4	4	3	3	3	3
Endurance	After 1000 hours application of WV at 105°C, the capacitors shall meet following requirements. (a) Capacitance Change: Within ±20% of the Initial Value (b) Dissipation Factor: Not Exceeding 200% of Specified Value (c) Leakage Current: Not Exceeding the Specified Value							
Shelf Life	After having been placed at 105°C without voltage applied for 1000 hours, the capacitors shall meet the same requirements as Endurance.							

## DIMENSIONS

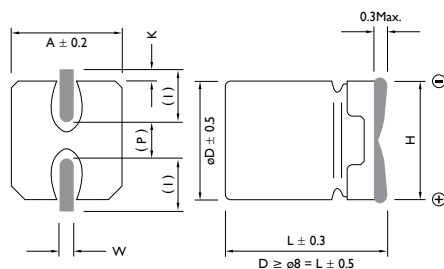

( ) Reference Size

Unit: mm

SIZE CODE	Dø	L	A	H	I	W	P	K
B	4.0	5.4	4.3	5.5 Max.	1.8	0.65 ± 0.1	1.0 ± 0.2	0.35 <sup>+ 0.15</sup> <sub>- 0.20</sub>
C	5.0	5.4	5.3	6.5 Max.	2.2	0.65 ± 0.1	1.5 ± 0.2	0.35 <sup>+ 0.15</sup> <sub>- 0.20</sub>
D	6.3	5.4	6.6	7.8 Max.	2.6	0.65 ± 0.1	1.8 ± 0.2	0.35 <sup>+ 0.15</sup> <sub>- 0.20</sub>
E	8.0	6.5	8.3	9.5 Max.	3.4	0.65 ± 0.1	2.2 ± 0.2	0.35 <sup>+ 0.15</sup> <sub>- 0.20</sub>
F	8.0	10.5	8.3	10.0 Max.	3.4	0.90 ± 0.2	3.1 ± 0.2	0.70 ± 0.20
G	10.0	10.5	10.3	12.0 Max.	3.5	0.90 ± 0.2	4.6 ± 0.2	0.70 ± 0.20
H	6.3	7.7	6.6	7.8 Max.	2.6	0.65 ± 0.1	1.8 ± 0.2	0.35 <sup>+ 0.15</sup> <sub>- 0.20</sub>

## CASE SIZE & PERMISSIBLE RIPPLE CURRENT OF STANDARD PRODUCTS

D × L: mm

CAP. (μF)	RATED VOLTAGE WV (SURGE VOLTAGE WV)							
	4 (5) SIZE				6.3 (8) SIZE			
		RIPPLE CURRENT	DISSIPATION FACTOR	ESR		RIPPLE CURRENT	DISSIPATION FACTOR	ESR
4.7	4 × 5.4	60	0.35	4.00				
6.8	4 × 5.4	60	0.35	4.00				
10	4 × 5.4	60	0.35	4.00				
22	4 × 5.4	60	0.35	4.00	4 × 5.4	60	0.26	4.00
33	4 × 5.4	60	0.35	4.00	5 × 5.4	95	0.26	2.60
47	4 × 5.4	60	0.35	4.00	5 × 5.4	95	0.26	2.60
68	4 × 5.4	60	0.35	4.00	6.3 × 5.4	140	0.26	1.30
100	5 × 5.4	95	0.35	3.00	6.3 × 5.4	140	0.26	1.30
150	6.3 × 5.4	140	0.35	2.60	8 × 6.5	230	0.35	0.80
220	6.3 × 5.4	140	0.35	2.60	8 × 6.5	230	0.35	0.80
330					8 × 10.5	450	0.35	0.50
470					10 × 10.5	670	0.35	0.30
1000					10 × 10.5	670	0.35	0.30

Note: 1. Ripple Current: (mA/rms) 105°C, 100KHz

2. Dissipation Factor: 20°C, 120Hz

3. ESR: 20°C, 100KHz (Ω)

## CASE SIZE & PERMISSIBLE RIPPLE CURRENT OF STANDARD PRODUCTS

D × L: mm

CAP. (μF)	RATED VOLTAGE WV (SURGE VOLTAGE WV)							
	10 (13) SIZE				16 (20) SIZE			
		RIPPLE CURRENT	DISSIPATION FACTOR	ESR		RIPPLE CURRENT	DISSIPATION FACTOR	ESR
4.7					4 × 5.4	60	0.16	4.00
6.8					4 × 5.4	60	0.16	4.00
10	4 × 5.4	60	0.22	4.00	4 × 5.4	60	0.16	4.00
22	5 × 5.4	95	0.22	2.60	5 × 5.4	95	0.16	2.60
33	5 × 5.4	95	0.22	2.60	5 × 5.4	95	0.16	2.60
47	6.3 × 5.4	95	0.22	1.30	6.3 × 5.4	140	0.16	1.30
68	6.3 × 5.4	140	0.22	1.30	8 × 6.5	230	0.20	0.80
100	6.3 × 5.4	140	0.22	1.30	8 × 6.5	230	0.20	0.80
150	8 × 6.5	230	0.26	0.80	10 × 10.5	450	0.20	0.50
220	8 × 6.5	230	0.26	0.80	10 × 10.5	450	0.20	0.50
330	8 × 10.5	450	0.26	0.50	10 × 10.5	670	0.20	0.30
470	10 × 10.5	670	0.26	0.30	10 × 10.5	670	0.20	0.30
1000	10 × 10.5	670	0.26	0.30				

Note: 1. Ripple Current: (mA/rms) 105°C, 100KHz

2. Dissipation Factor: 20°C, 120Hz

3. ESR: 20°C, 100KHz (Ω)

## CASE SIZE & PERMISSIBLE RIPPLE CURRENT OF STANDARD PRODUCTS

D x L: mm

CAP. ( $\mu$ F)	RATED VOLTAGE WV (SURGE VOLTAGE WV)											
	25 (32)				35 (44)				50 (63)			
	SIZE	RIPPLE CURRENT	DISSIPATION FACTOR	ESR	SIZE	RIPPLE CURRENT	DISSIPATION FACTOR	ESR	SIZE	RIPPLE CURRENT	DISSIPATION FACTOR	ESR
0.10									4 x 5.4	60	0.12	5.00
0.22									4 x 5.4	60	0.12	5.00
0.33									4 x 5.4	60	0.12	5.00
0.47									4 x 5.4	60	0.12	5.00
1.0					4 x 5.4	60	0.12	4.00	4 x 5.4	60	0.12	5.00
2.2					4 x 5.4	60	0.12	4.00	4 x 5.4	60	0.12	5.00
3.3					4 x 5.4	60	0.12	4.00	4 x 5.4	60	0.12	5.00
4.7	4 x 5.4	60	0.14	4.00	4 x 5.4	60	0.12	4.00	5 x 5.4	95	0.12	4.00
6.8	4 x 5.4	60	0.14	4.00	5 x 5.4	95	0.12	2.60	6.3 x 5.4	140	0.12	2.60
10	5 x 5.4	95	0.14	2.60	5 x 5.4	95	0.12	2.60	6.3 x 5.4	140	0.12	2.60
22	6.3 x 5.4	140	0.14	1.30	6.3 x 5.4	140	0.12	1.30	8 x 6.5	230	0.12	1.30
33	6.3 x 5.4	140	0.14	1.30	8 x 6.5	230	0.14	0.80	8 x 10.5	300	0.12	1.10
47	6.3 x 5.4	140	0.14	1.30	8 x 6.5	230	0.14	0.80	10 x 10.5	670	0.12	0.80
68	8 x 10.5	450	0.16	0.50	8 x 10.5	450	0.14	0.50	10 x 10.5	670	0.12	0.80
100	8 x 10.5	450	0.16	0.50	10 x 10.5	670	0.14	0.30	10 x 10.5	670	0.12	0.80
150	10 x 10.5	670	0.16	0.30	10 x 10.5	670	0.14	0.30				
220	10 x 10.5	670	0.16	0.30	10 x 10.5	670	0.14	0.30				

Note: 1. Ripple Current: (mA/rms) 105°C, 100KHz

2. Dissipation Factor: 20°C, 120Hz

3. ESR: 20°C, 100KHz ( $\Omega$ )

# CX [ Ultra Low Impedance & Long Life ]

105°C 3000 ~ 5000 Hours, 6.3-50V

## Surface Mount Aluminum Electrolytic

### ELECTRICAL CHARACTERISTICS

Operation Temperature Range	-40 ~ +105°C																					
Rated Voltage Range	6.3 ~ 50VDC																					
Rated Capacitance Range	1 ~ 1000 $\mu$ F																					
Capacitance Tolerance	$\pm$ 20% at 120Hz, 20°C																					
Leakage Current (Max. 20°C)	$I \leq 0.01CV$ or $3\mu A$ (After Rated Voltage Applied for 2 Minutes) I = Leakage Current ( $\mu A$ ), C = Nominal Capacitance ( $\mu F$ ), V = Rated Voltage (V)																					
Dissipation Factor (Max.) (tan $\delta$ ) (20°C, 120Hz)	Shown in the table of standard rating																					
Low Temperature Stability	Impedance Ratio (Max.) <table border="1"> <tr> <td>WV (V):</td> <td>6.3</td> <td>10</td> <td>16</td> <td>25</td> <td>35</td> <td>50</td> </tr> <tr> <td>Z-25°C/Z+20°C:</td> <td>2</td> <td>2</td> <td>2</td> <td>2</td> <td>2</td> <td>2</td> </tr> <tr> <td>Z-40°C/Z+20°C:</td> <td>3</td> <td>3</td> <td>3</td> <td>3</td> <td>3</td> <td>3</td> </tr> </table>	WV (V):	6.3	10	16	25	35	50	Z-25°C/Z+20°C:	2	2	2	2	2	2	Z-40°C/Z+20°C:	3	3	3	3	3	3
WV (V):	6.3	10	16	25	35	50																
Z-25°C/Z+20°C:	2	2	2	2	2	2																
Z-40°C/Z+20°C:	3	3	3	3	3	3																
Endurance	After the rated voltage has been applied at 105°C for 3000~5000 hours, the capacitors shall meet the following requirements. (a) Capacitance Change: Within $\pm$ 30% of Initial Value (b) Dissipation Factor: Not Exceeding 300% of the Specified Value (c) Leakage Current: Initial Specified Value or Less <table border="1"> <tr> <td>D<math>\phi</math>:</td> <td>4 x 5.8~8 x 6.5<math>\phi</math></td> <td><math>\geq</math>8 x 10.5~10 x 10.5<math>\phi</math></td> </tr> <tr> <td>Load Life:</td> <td>3000hrs</td> <td>5000hrs</td> </tr> </table>	D $\phi$ :	4 x 5.8~8 x 6.5 $\phi$	$\geq$ 8 x 10.5~10 x 10.5 $\phi$	Load Life:	3000hrs	5000hrs															
D $\phi$ :	4 x 5.8~8 x 6.5 $\phi$	$\geq$ 8 x 10.5~10 x 10.5 $\phi$																				
Load Life:	3000hrs	5000hrs																				
Shelf Life	After having been placed at 105°C without voltage applied for 1000 hours, the capacitors shall meet the same requirements as Endurance.																					

### DIMENSIONS

D $\phi$	L	A	H	I	W	P	K
4.0	5.8	4.3	5.5 Max.	1.8	0.65 $\pm$ 0.1	1.0 $\pm$ 0.2	0.35 $^{+0.15}_{-0.20}$
5.0	5.8	5.3	6.5 Max.	2.2	0.65 $\pm$ 0.1	1.5 $\pm$ 0.2	0.35 $^{+0.15}_{-0.20}$
6.3	5.8	6.6	7.8 Max.	2.6	0.65 $\pm$ 0.1	1.8 $\pm$ 0.2	0.35 $^{+0.15}_{-0.20}$
6.3	7.7	6.6	7.8 Max.	2.6	0.65 $\pm$ 0.1	1.8 $\pm$ 0.2	0.35 $^{+0.15}_{-0.20}$
8.0	6.5	8.3	9.5 Max.	3.4	0.65 $\pm$ 0.1	2.2 $\pm$ 0.2	0.35 $^{+0.15}_{-0.20}$
8.0	10.5	8.3	10.0 Max.	3.4	0.90 $\pm$ 0.2	3.1 $\pm$ 0.2	0.70 $\pm$ 0.20
10.0	10.5	10.3	12.0 Max.	3.5	0.90 $\pm$ 0.2	4.6 $\pm$ 0.2	0.70 $\pm$ 0.20



### FEATURE

105°C 3,000~5,000 hours, low profile vertical chip, ultra low impedance

Applications: AV(TV, Video, Audio), Monitor/Computer, OA/HA/Communication, SMPS

### MULTIPLIER FOR RIPPLE CURRENT

Frequency Coefficient

FREQUENCY (Hz)	120	1K	10K	100K
COEFFICIENT	0.70	0.80	0.90	1.00

Unit: mm

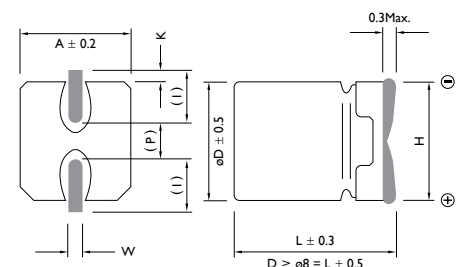

( ) Reference Size

## CASE SIZE & PERMISSIBLE RIPPLE CURRENT OF STANDARD PRODUCTS

D x L: mm

CAP. ( $\mu$ F)	RATED VOLTAGE WV (SURGE VOLTAGE WV)								
	6.3 (8) SIZE			10 (13) SIZE			16 (20) SIZE		
	SIZE	RIPPLE CURRENT	Imp.	SIZE	RIPPLE CURRENT	Imp.	SIZE	RIPPLE CURRENT	Imp.
22	4 x 5.8	90	1.35	4 x 5.8	90	1.35	5 x 5.8	160	0.70
33	4 x 5.8	90	1.35	5 x 5.8	150	0.80	6.3 x 5.8	240	0.52
47	5 x 5.8	160	0.80	6.3 x 5.8	160	0.70	6.3 x 5.8	240	0.52
100	6.3 x 5.8	230	0.70	6.3 x 5.8	240	0.44	6.3 x 7.7	280	0.36
150	6.3 x 5.8	230	0.44	6.3 x 7.7	240	0.44	8 x 6.5	280	0.36
220	6.3 x 7.7	240	0.36	6.3 x 7.7	280	0.16	6.3 x 7.7	280	0.28
330	8 x 10.5	280	0.28	8 x 10.5	650	0.16	8 x 10.5	450	0.17
470	8 x 10.5	650	0.16	10 x 10.5	650	0.16	10 x 10.5	670	0.09
680	10 x 10.5	850	0.085	10 x 10.5	850	0.09	10 x 10.5	670	0.09
1000	10 x 10.5	850	0.085	10 x 10.5	850	0.09	10 x 12.5	1000	0.075
1500	10 x 12.5	1000	0.075	10 x 12.5	1000	0.075			
2200	10 x 12.5	1000	0.075						

Note: 1. Ripple Current: (mA/rms) 105°C, 100KHz  
 2. Dissipation Factor: 20°C, 120Hz  
 3. ESR: 100KHz / 20°C ( $\Omega$  Max.)

## CASE SIZE & PERMISSIBLE RIPPLE CURRENT OF STANDARD PRODUCTS

D x L: mm

CAP. ( $\mu$ F)	RATED VOLTAGE WV (SURGE VOLTAGE WV)								
	25 (32) SIZE			35 (44) SIZE			50 (63) SIZE		
	SIZE	RIPPLE CURRENT	Imp.	SIZE	RIPPLE CURRENT	Imp.	SIZE	RIPPLE CURRENT	Imp.
4.7				4 x 5.8	80	1.35	6.3 x 7.7	85	1.52
10	4 x 5.8	90	1.35	5 x 5.8	150	0.80	5 x 5.8	85	1.50
22	5 x 5.8	160	0.70	6.3 x 5.8	160	0.36	6.3 x 5.8	165	0.88
33	6.3 x 5.8	230	0.44	6.3 x 5.8	230	0.44	6.3 x 7.7	185	0.68
47	6.3 x 5.8	230	0.44	6.3 x 7.7	280	0.28	6.3 x 7.7	195	0.68
68							8x10.5	195	0.34
100	8 x 6.5	280	0.36	8 x 10.5	650	0.16	10x10.5	369	0.18
150	8 x 10.5	280	0.17	10 x 10.5	850	0.09			
220	8 x 10.5	450	0.17	10 x 10.5	850	0.09	10 x 12.5	700	0.16
330	8 x 10.5	450	0.17	10 x 10.5	670	0.09			

Note: 1. Ripple Current: (mA/rms) 105°C, 100KHz  
 2. Dissipation Factor: 20°C, 120Hz  
 3. ESR: 100KHz / 20°C ( $\Omega$  Max.)

# CD [Ultra Low Impedance]

105°C 2000 Hours, 6.3-50V

## Surface Mount Aluminum Electrolytic

### ELECTRICAL CHARACTERISTICS

Operation Temperature Range	-40 to +105°C					
Rated Voltage Range	6.3 to 35VDC					
Rated Capacitance Range	4.7 ~ 1500 $\mu$ F					
Capacitance Tolerance	$\pm$ 20% at 120Hz, 20°C					
Leakage Current (Max. 20°C)	$I \leq 0.01CV$ ( $\mu$ A) or 3 $\mu$ A (After 2 Minutes Application of DC Rated Voltage at 20°C) $I$ = Leakage Current ( $\mu$ A), $C$ = Rated Capacitance ( $\mu$ F), $V$ = Rated Voltage (V)					
Dissipation Factor (tan $\delta$ ) (120Hz, 20°C)	WV(V)	6.3	10	16	25	35
	tan $\delta$	0.26	0.19	0.16	0.14	0.12
Low Temperature Stability	Impedance Ratio at 120Hz					
	WV (V)	6.3	10	16	25	35
	Z (-25°C) / Z (+20°C)	2	2	2	2	2
	Z (-40°C) / Z (+20°C)	3	3	3	3	3
Endurance	After the WV has been applied at 105°C for 2000 hours, the capacitors shall meet following requirements. (a) Capacitance Change: Within $\pm$ 30% of the Initial Value (b) Dissipation Factor: Not Exceeding 200% of Specified Value (c) Leakage Current: Not Exceeding the Specified Value					
Shelf Life	After having been placed at 105°C without voltage applied for 1000 hours, the capacitors shall meet the same requirements as Endurance.					

### DIMENSIONS

SIZE CODE	D $\phi$	L	A	H	I	W	P	K
B	4.0	5.4	4.3	5.5 Max.	1.8	0.65 $\pm$ 0.1	1.0 $\pm$ 0.2	0.35 $^{+0.15}_{-0.20}$
C	5.0	5.4	5.3	6.5 Max.	2.2	0.65 $\pm$ 0.1	1.5 $\pm$ 0.2	0.35 $^{+0.15}_{-0.20}$
D	6.3	5.4	6.6	7.8 Max.	2.6	0.65 $\pm$ 0.1	1.8 $\pm$ 0.2	0.35 $^{+0.15}_{-0.20}$
E	8.0	6.5	8.3	9.5 Max.	3.4	0.65 $\pm$ 0.1	2.2 $\pm$ 0.2	0.35 $^{+0.15}_{-0.20}$
F	8.0	10.5	8.3	10.0 Max.	3.4	0.90 $\pm$ 0.2	3.1 $\pm$ 0.2	0.70 $\pm$ 0.20
G	10.0	10.5	10.3	12.0 Max.	3.5	0.90 $\pm$ 0.2	4.6 $\pm$ 0.2	0.70 $\pm$ 0.20
H	6.3	7.7	6.6	7.8 Max.	2.6	0.65 $\pm$ 0.1	1.8 $\pm$ 0.2	0.35 $^{+0.15}_{-0.20}$



### FEATURE

For Ultra Low Impedance Series with 105°C 2000 Hours  
 Suitable for AV (TV, Video, Audio), Monitor / Computer,  
 OA / HA / Communication, SMPS

### MARKING

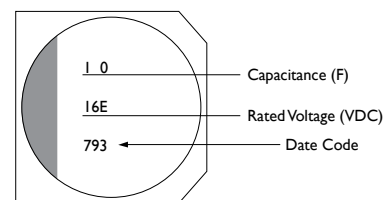

Unit: mm

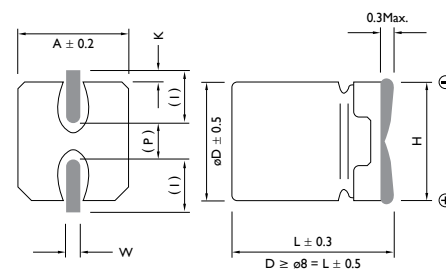

( ) Reference Size

## CASE SIZE & PERMISSIBLE RIPPLE CURRENT OF STANDARD PRODUCTS

D x L: mm

CAP. (μF)	RATED VOLTAGE WV (SURGE VOLTAGE WV)								
	6.3 (8) SIZE			10 (13) SIZE			16 (20) SIZE		
	SIZE	RIPPLE	ESR	SIZE	RIPPLE	ESR	SIZE	RIPPLE	ESR
22	4 x 5.4	90	1.93	4 x 5.4	90	1.93	4 x 5.4	90	1.93
							5 x 5.4	160	1.00
33	4 x 5.4	90	1.93	4 x 5.4	90	1.93	5 x 5.4	160	1.00
				5 x 5.4	160	1.00			
47	4 x 5.4	90	1.93	6.3 x 5.4	190	0.52	5 x 5.4	160	1.00
	5 x 5.4	160	1.00				6.3 x 5.4	240	0.52
100	5 x 5.4	160	1.00	6.3 x 5.4	190	0.52	6.3 x 5.4	240	0.52
	6.3 x 5.4	240	0.52						
150	8 x 6.5	240	0.30	6.3 x 7.7	240	0.34	6.3 x 7.7	280	0.34
220	8 x 6.5	240	0.30	6.3 x 7.7	280	0.34	6.3 x 7.7	330	0.34
				8 x 6.5	300	0.26	8 x 10.5	370	0.22
330	6.3 x 7.7	280	0.34	8 x 10.5	600	0.16	8 x 10.5	600	0.16
	8 x 6.5	300	0.26						
470	8 x 10.5	600	0.16	8 x 10.5	600	0.16	8 x 10.5	600	0.16
							10 x 10.5	600	0.08
680	8 x 10.5	600	0.16	10 x 10.5	600	0.12	10 x 10.5	850	0.08
820							10 x 10.5	850	0.08
1000	10 x 10.5	600	0.16						
1200	10 x 10.5	700	0.16						
1500	10 x 10.5	850	0.08						

Note: 1. Ripple Current: (mA/rms) 105°C, 100KHz

2. ESR: 100KHz / 20°C (Ω Max.)

## CASE SIZE & PERMISSIBLE RIPPLE CURRENT OF STANDARD PRODUCTS

D x L: mm

CAP. (μF)	RATED VOLTAGE WV (SURGE VOLTAGE WV)					
	25 (32) SIZE			35 (44) SIZE		
		RIPPLE	ESR		RIPPLE	ESR
4.7				4 x 5.4	90	1.93
10	4 x 5.4	90	1.93	4 x 5.4	90	1.93
				5 x 5.4	160	1.00
22	5 x 5.4	160	1.00	5 x 5.4	160	1.00
33	5 x 5.4	160	1.00	6.3 x 5.4	240	0.52
	6.3 x 5.4	240	0.52			
47	6.3 x 5.4	240	0.52	6.3 x 5.4	240	0.52
68	6.3 x 5.4	240	0.52	6.3 x 7.7	280	0.34
100	6.3 x 7.7	280	0.34	6.3 x 7.7	280	0.34
	8 x 6.5	300	0.26	8 x 10.5	600	0.16
				10 x 10.5	850	0.08
150	8 x 10.5	600	0.16	8 x 10.5	600	0.16
220	8 x 10.5	600	0.16	10 x 10.5	600	0.16
330	10 x 10.5	600	0.16	10 x 10.5	850	0.08
470	10 x 10.5	850	0.08			

Note: 1. Ripple Current: (mA/rms) 105°C, 100KHz

2. ESR: 100KHz / 20°C (Ω Max.)



# Surface Mount Aluminum Electrolytic

# CJ [ Long Life and High Reliability ]

105°C 5000 Hours, 160-400V



## FEATURES

- 8 $\phi$ ~10 $\phi$ , 105°C 5,000 hours assured
- For surface mounting on high density pc board.
- RoHS compliance

### MULTIPLIER FOR RIPPLE CURRENT

Frequency Coefficient

FREQUENCY (Hz)	120	1K	10K	100K
COEFFICIENT	0.70	0.80	0.90	1.00

## ELECTRICAL CHARACTERISTICS

Operation Temperature Range	-40 ~ +105°C		
Rated Voltage Range	160 ~ 400VDC		
Rated Capacitance Range	1 ~ 22 $\mu$ F		
Capacitance Tolerance	$\pm$ 20% at 120Hz, 20°C		
Leakage Current (Max. 20°C)	I $\leq$ 0.01 CV or 3 $\mu$ A (After Rated Voltage Applied for 2 Minutes) I = Leakage Current ( $\mu$ A), C = Nominal Capacitance ( $\mu$ F), V = Rated Voltage (V)		
Dissipation Factor (Max.) (tan $\delta$ ) (20°C, 120Hz)	Shown in the table of standard rating		
Low Temperature Stability	Impedance Ratio (Max.)		
	WV (V) :	160~250	350~400
	Z-25°C/Z+20°C :	3	6
	Z-40°C/Z+20°C :	6	10
Endurance	After the rated voltage has been applied at 155°C for 3000~5000 hours, the capacitors shall meet the following requirements. (a) Capacitance Change: Within $\pm$ 30% of Initial Value (b) Dissipation Factor: Not Exceeding 200% of the Specified Value (c) Leakage Current: Initial Specified Value or Less		
Shelf Life	After having been placed at 105°C without voltage applied for 1000 hours, the capacitors shall meet the same requirements as Endurance.		

## DIMENSIONS

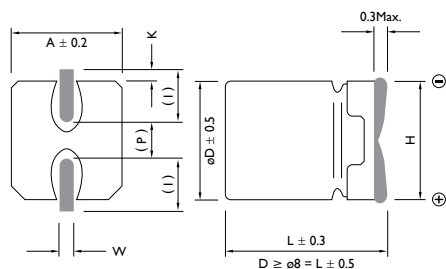

( ) Reference Size

Unit: mm

D $\phi$	L	A	H	I	W	P	K
4.0	5.4	4.3	5.5 Max.	1.8	0.65 $\pm$ 0.1	1.0 $\pm$ 0.2	0.35 $\begin{matrix} + 0.15 \\ - 0.20 \end{matrix}$
5.0	5.4	5.3	6.5 Max.	2.2	0.65 $\pm$ 0.1	1.5 $\pm$ 0.2	0.35 $\begin{matrix} + 0.15 \\ - 0.20 \end{matrix}$
6.3	5.4	6.6	7.8 Max.	2.6	0.65 $\pm$ 0.1	1.8 $\pm$ 0.2	0.35 $\begin{matrix} + 0.15 \\ - 0.20 \end{matrix}$
6.3	7.7	6.6	7.8 Max.	2.6	0.65 $\pm$ 0.1	1.8 $\pm$ 0.2	0.35 $\begin{matrix} + 0.15 \\ - 0.20 \end{matrix}$
8.0	6.5	8.3	9.5 Max.	3.4	0.65 $\pm$ 0.1	2.2 $\pm$ 0.2	0.35 $\begin{matrix} + 0.15 \\ - 0.20 \end{matrix}$
8.0	10.5	8.3	10.0 Max.	3.4	0.90 $\pm$ 0.2	3.1 $\pm$ 0.2	0.70 $\pm$ 0.20
10.0	10.5	10.3	12.0 Max.	3.5	0.90 $\pm$ 0.2	4.6 $\pm$ 0.2	0.70 $\pm$ 0.20
10.0	12.5	10.3	12.0 Max.	3.5	0.90 $\pm$ 0.2	4.7 $\pm$ 0.2	0.70 $\pm$ 0.20

## CASE SIZE & PERMISSIBLE RIPPLE CURRENT OF STANDARD PRODUCTS

CAP. (μF)	RATED VOLTAGE WV (SURGE VOLTAGE WV)									
	160 (200)		200 (250)		250 (300)		350 (400)		400 (450)	
	SIZE	RIPPLE	SIZE	RIPPLE	SIZE	RIPPLE	SIZE	RIPPLE	SIZE	RIPPLE
1									8 × 10.5	42
2.2							8 × 10.5	44	8 × 12.5	40
3.3			8 × 10.5	55	8 × 10.5	34	8 × 10.5	43	10 × 10.5	58
4.7	8 × 10.5	68	8 × 10.5	53	8 × 10.5	34	10 × 10.5	60	10 × 10.5	56
5.6	8 × 10.5	67	8 × 10.5	51	8 × 10.5	36	10 × 10.5	58	10 × 12.5	72
6.8	8 × 10.5	65	8 × 10.5	49	8 × 12.5	38	10 × 10.5	56	10 × 12.5	70
8.2	8 × 10.5	64	8 × 12.5	43	10 × 10.5	50	10 × 12.5	73	10 × 12.5	68
10	8 × 12.5	59	10 × 10.5	53	10 × 12.5	72	10 × 12.5	71	10 × 12.5	65
15	10 × 12.5	72	10 × 12.5	75						

Note: 1. Ripple Current: (mA/rms) 105°C, 100KHz

2. Dissipation Factor: 20°C, 120Hz

3. ESR: 100KHz / 20°C (Ω Max.)

# Surface Mount Aluminum Electrolytic

# CH [ Ultra Low Impedance & High Temperature ]

125°C 1000~2000 Hours Assurance



## FEATURE

125°C 2,000 hours, higher temperature range, low profile vertical chip, low impedance

Applications: Automatic Mounting and Reflow Soldering

### MULTIPLIER FOR RIPPLE CURRENT

Frequency Coefficient

FREQUENCY (Hz)	120	1K	10K	100K
COEFFICIENT	0.70	0.80	0.90	1.00

## ELECTRICAL CHARACTERISTICS

Operation Temperature Range	-40 ~ +125°C						
Rated Voltage Range	6.3 ~ 50VDC						
Rated Capacitance Range	47 ~ 1000μF						
Capacitance Tolerance	±20% at 120Hz, 20°C						
Leakage Current (Max. 20°C)	I ≤ 0.01CV or 3μA (After Rated Voltage Applied for 2 Minutes) I = Leakage Current (μA), C=Nominal Capacitance (μF), V=Rated Voltage (V)						
Dissipation Factor (Max.) (tanδ) (120Hz, 20°C)	Shown in the table of standard rating						
Low Temperature Stability	Impedance Ratio (Max.)						
	WV (V) :	6.3	10	16	25	35	50
	Z-25°C/Z+20°C :	2	2	2	2	2	2
	Z-40°C/Z+20°C :	3	3	3	3	3	3
Endurance	After the rated voltage has been applied at 125°C for 1000~2000 hours, the capacitors shall meet the following requirements. (a) Capacitance Change: Within ±30% of the Initial Value (b) Dissipation Factor: Not Exceeding 300% of Specified Value (c) Leakage Current: Not Exceeding the Specified Value						
	D∅ :	≤ 8 × 6.5∅			≥ 8 × 10.5∅		
	Load Life :	1000hrs			2000hrs		
Shelf Life	After having been placed at 125°C without voltage applied for 1000 hours (500 hours for 8 × 6.5, the capacitors shall meet the same requirements as Endurance.						

## DIAGRAM OF DIMENSIONS

Dimensions: mm

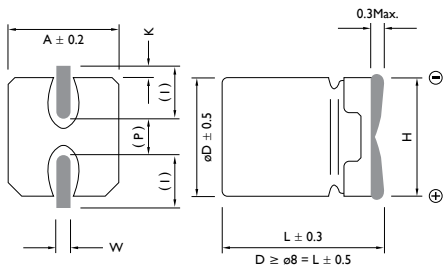

( ) Reference Size

SIZE CODE	D∅	L	A	H	I	W	P	K
E	8.0	6.5	8.3	9.5 Max.	3.4	0.65 ± 0.1	2.2 ± 0.2	0.35 + 0.15 / - 0.75
F	8.0	10.5	8.3	10.0 Max.	3.4	0.90 ± 0.2	3.1 ± 0.2	0.70 ± 0.2
G	10.0	10.5	10.3	12.0 Max.	3.5	0.90 ± 0.2	4.6 ± 0.2	0.70 ± 0.2
Z	10.0	12.2	10.3	12.0 Max.	3.5	0.90 ± 0.2	4.6 ± 0.2	0.70 ± 0.2

## CASE SIZE & PERMISSIBLE RIPPLE CURRENT OF STANDARD PRODUCTS

D x L: mm

CAP. ( $\mu$ F)	RATED VOLTAGE WV (SURGE VOLTAGE WV)											
	6.3 (8)				10 (13)				16 (20)			
	SIZE	RIPPLE CURRENT	DISSIPATION FACTOR	ESR	SIZE	RIPPLE CURRENT	DISSIPATION FACTOR	ESR	SIZE	RIPPLE CURRENT	DISSIPATION FACTOR	ESR
100	8 x 6.5	100	0.30	0.50	8 x 6.5	100	0.26	0.50	8 x 6.5	100	0.20	0.50
150	8 x 6.5	100	0.30	0.50	8 x 6.5	100	0.26	0.50	8 x 10.5	197	0.20	0.30
220	8 x 6.5	100	0.30	0.50	8 x 10.5	197	0.26	0.30	8 x 10.5	197	0.20	0.30
330	8 x 10.5	197	0.30	0.30	8 x 10.5	197	0.26	0.30	8 x 10.5	197	0.20	0.30
470	8 x 10.5	197	0.30	0.30	10 x 10.5	297	0.26	0.20	10 x 10.5	297	0.20	0.20
680	10 x 10.5	297	0.30	0.20	10 x 10.5	297	0.26	0.20				
1000	10 x 10.5	297	0.30	0.20								

Note: 1. Ripple Current: (mA/rms) 125°C, 100KHz

2. Dissipation Factor: 20°C, 120Hz

3. ESR: 100KHz / 20°C ( $\Omega$  Max.)

## CASE SIZE & PERMISSIBLE RIPPLE CURRENT OF STANDARD PRODUCTS

D x L: mm

CAP. ( $\mu$ F)	RATED VOLTAGE WV (SURGE VOLTAGE WV)											
	25 (32)				35 (44)				50 (63)			
	SIZE	RIPPLE CURRENT	DISSIPATION FACTOR	ESR	SIZE	RIPPLE CURRENT	DISSIPATION FACTOR	ESR	SIZE	RIPPLE CURRENT	DISSIPATION FACTOR	ESR
47	8 x 6.5	100	0.18	0.50	8 x 10.5	197	0.14	0.30	8 x 10.5	133	0.12	0.75
100	8 x 10.5	197	0.18	0.30	8 x 10.5	197	0.14	0.30	10 x 10.5	221	0.12	0.50
150	8 x 10.5	197	0.18	0.30	10 x 10.5	297	0.14	0.20				
220	10 x 10.5	297	0.18	0.20	10 x 10.5	297	0.14	0.20				
330	10 x 10.5	297	0.18	0.20								

Note: 1. Ripple Current: (mA/rms) 125°C, 100KHz

2. Dissipation Factor: 20°C, 120Hz

3. ESR: 100KHz / 20°C ( $\Omega$  Max.)



# VP [ Low ESR ]

SMD 2000 hrs 105°C

## Conductive Polymer Solid Capacitors

### ELECTRICAL CHARACTERISTICS

Operation Temperature Range	-55 ~ +105°C	
Rated Voltage Range	2.5 ~ 25V	
Rated Capacitance Range	22 ~ 1500µF	
Capacitance Tolerance	± 20% at 120Hz, 20°C	
Leakage Current (Max. 20°C)	$I \leq 0.2CV$ (µA) ( After Rated Voltage Applied for 2 Minutes ) I = Leakage Current (µA), C = Rated Capacitance (µF), V = Rated Voltage (V)	
Dissipation Factor at 120Hz, 20°C	$WV(V)$ 2.5 ~ 25V D.F (%)              12	
Low Temperature Stability	Impedance Ratio at 20°C (Max.) $WV(V)$ 2.5 ~ 16V (Rated Voltage) Impedance    Z - 25°C / Z + 20°C      ≤ 1.15 Z - 55°C / Z + 20°C      ≤ 1.25	
Endurance	After the rated voltage has been applied at 105°C for 2000 hours, the capacitors shall meet the follow requirements. (a) Appearance: No Significant Damage (b) Capacitance Change: Within ±20% of the Initial Value (c) Dissipation Factor: Not Exceeding 150% of the Initial Specified Value (d) Equivalent Series Resistance: Not Exceeding 150% of the Initial Specified Value (e) Leakage Current: Not more than the Initial Specified Value	
Humidity Test	After subjected 90 to 95% RH for 1000 hours at 60°C, the capacitors shall meet the requirements as Endurance.	

### DIAGRAM OF DIMENSIONS

Dø	L	A	H	I	W	P	K	
5	5.8	5.3	6.5 Max	2.2	0.65±0.15	1.5±0.2	0.35	+0.15 -0.2
6.3	5.8	6.6	7.8 Max	2.6	0.65±0.15	1.8±0.2	0.35	+0.15 -0.2
6.3	7.7	6.6	7.8 Max	2.6	0.65±0.15	1.8±0.2	0.35	+0.15 -0.2
8	6.7	8.3	9.5 Max	3.4	0.65±0.15	2.2±0.2	0.35	+0.15 -0.2
8	10.4	8.3	10.0 Max	3.4	0.90±0.2	3.1±0.2	0.70±0.20	
10	10.0	10.3	12.0 Max	3.5	0.90±0.2	4.6±0.2	0.70±0.20	
10	12.2	10.3	12.0 Max	3.5	0.90±0.2	4.6±0.2	0.70±0.20	

• Multiplier for Ripple Current

Frequency (Hz)	120 ≤ F < 1K	1K ≤ F < 10K	10K ≤ F < 100K	100K ≤ F ≤ 500K
Coefficient	0.05	0.3	0.7	1



### DESCRIPTION

105°C, 2000hrs, Standard, 2.5~25VDC  
 Low ESR, High Ripple Current Capability  
 RoHS Compliant

Dimensions: mm

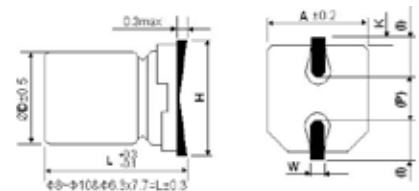

# Conductive Polymer Aluminum Solid Electrolytic Capacitors

# VP

## ■ Dimensions, Rated Ripple Current, Equivalent Series Resistance

Capacitance ( $\mu$ F)	Rated Voltage							
	2.5V				4V			
	SIZE	RIPPLE	ESR	LC( $\mu$ A max/2min)	SIZE	RIPPLE	ESR	LC( $\mu$ A max/2min)
100					6.3x5.8	2450	26	300
120					5x5.8	1490	30	300
150					6.3x5.8	2450	26	300
180	6.3x5.8	2200	25	300				
220	6.3x5.8	2500	25	300				
330					6.3x7.7	2650	25	300
390	6.3x7.7	2720	23	300				
470	6.3x7.7	2720	23	300				
560	6.3x5.8	2500	25	300	8x10.4	3950	18	448
820					8x10.4	3950	18	656
					10x12.2	5500	10	656
1000	8x10.4	3950	18	500				
1200	10x10.0	4000	12	600	10x10.0	4000	12	960
					10x12.2	5500	10	960
1500	10x10.0	4000	12	750				
	10x12.2	5500	10	750				

Capacitance ( $\mu$ F)	Rated Voltage							
	6.3V				10V			
	SIZE	RIPPLE	ESR	LC( $\mu$ A max/2min)	SIZE	RIPPLE	ESR	LC( $\mu$ A max/2min)
22	5x5.8	1380	35	300	5x5.8	1270	40	300
33					5x5.8	1270	40	300
47	5x5.8	1380	35	300	5x5.8	1270	40	300
					6.3x5.8	2250	31	300
56					6.3x5.8	2250	31	300
68	6.3x5.8	2400	27	300				
82	6.3x5.8	2400	27	300				
100	5x5.8	1380	35	300	6.3x5.8	2250	31	300
	6.3x5.8	2400	27	300	6.3x7.7	2560	27	300
120	6.3x5.8	2400	27	300	6.3x7.7	2560	27	300
					8x6.7	2800	27	300
150					6.3x7.7	2560	27	300
220	6.3x5.8	2400	27	300	8x6.7	3220	21	440
	6.3x7.7	2650	25	300				
	8x6.7	3020	25	300				
270	6.3x7.7	2650	25	340				
330	6.3x5.8	2400	270	416				
	6.3x7.7	2650	25	416				
390					8x10.4	3020	22	780
470	6.3x7.7	2650	25	592	10x10.0	3500	14	940
	8x10.4	3610	21	592	10x12.2	5300	12	940
560					10x12.2	5300	12	1120
680	8x10.4	3610	21	857				
	10x10.0	3650	12	857				
	10x12.2	5500	10	857				
820	8x10.4	3610	21	1033				
	10x10.0	3650	12	1033				
	10x12.2	5500	10	1033				
1000	8x10.4	3610	21	1260	10x12.2	4800	13	2000

☆ SIZE :  $\varphi$ DxL(mm) ☆  $\tan\delta$ :20°C,120Hz. ☆ Ripple Current:(mA/rms),105°C .100KHz ☆ ESR(m $\Omega$ ),20°C.100KHz

# Conductive Polymer Aluminum Solid Electrolytic Capacitors

**VP** Standard SMD type

■ Dimensions, Rated Ripple Current, Equivalent Series Resistance

Capacitance (μF)	Rated Voltage							
	16V				20V			
	SIZE	RIPPLE	ESR	LC(μA max/2min)	SIZE	RIPPLE	ESR	LC(μA max/2min)
22	5x5.8	1210	90	300	6.3X5.8	1650	50	300
33	6.3x5.8	2050	37	300	8X6.7	1900	45	300
39	6.3x5.8	2050	37	300				
47	6.3x5.8	1600	50	300	6.3X7.7	2000	45	300
					8X6.7	1900	45	300
82	6.3x7.7	2420	30	300				
	8X6.7	2700	30	300				
100	6.3x7.7	2420	30	320	8X10.4	3320	24	400
120	6.3X7.7	2420	30	320				
150	8X10.4	3490	23	480				
180	8x10.4	3490	23	576				
220	8x10.4	3490	23	704				
	10x12.2	5050	14	704				
270	8x10.4	3490	23	864				
330	10x10.0	3100	16	1056				
	10x12.2	5050	14	1056				
390	8X10.4	3000	23	1248				
470	10x10.0	3100	16	1504				
	10X12.2	5050	14	1056				
560	10X12.2	5050	14	1792				
680	10X12.2	5050	14	1056				
820	10X12.2	5050	14	2624				

Capacitance (μF)	Rated Voltage							
	25V							
	SIZE	RIPPLE	ESR	LC(μA max/2min)				
27	6.3X5.8	1270	60	300				
33	8X10.4	2500	30	300				
39								
47	6.3X7.7	1800	45	300				
100	8X10.4	3320	24	500				
180								
220	10X12.2	3800	28	1100				
270								
330								
680								

☆ SIZE : ψDxL(mm) ☆tanδ:20°C,120Hz. ☆Ripple Current:(mA/rms),105°C .100KHz ☆ ESR(mΩ).20°C.100KHz



# Conductive Polymer Solid Capacitors

# VS [ Long Life & High Ripple Current ]

SMD 5000 hrs 105°C



## DESCRIPTION

105°C, 5000hrs assured  
 Ultra low ESR, Solid Capacitors of SMD type  
 RoHS Compliant

## ELECTRICAL CHARACTERISTICS

Operation Temperature Range	-55 ~ +105°C		
Rated Voltage Range	4 ~ 20V		
Rated Capacitance Range	22 ~ 470µF		
Capacitance Tolerance	± 20% at 120Hz, 20°C		
Leakage Current (Max. 20°C)	$I \leq 0.2CV$ (µA) ( After Rated Voltage Applied for 2 Minutes ) I = Leakage Current (µA), C = Rated Capacitance (µF), V = Rated Voltage (V)		
Dissipation Factor at 120Hz, 20°C	WV(V)	4 ~ 16V	
	D.F (%)	12	
Low Temperature Stability	Impedance Ratio at 20°C (Max.)		
	WV (V)	2.5 ~ 16V	
	Impedance	$Z - 25^\circ\text{C} / Z + 20^\circ\text{C}$	$\leq 1.15$
		$Z - 55^\circ\text{C} / Z + 20^\circ\text{C}$	$\leq 1.25$ (Z: 100KHz)
Endurance	After the rated voltage has been applied at 105°C for 5000 hours, the capacitors shall meet the follow requirements.		
	(a) Appearance: No Significant Damage		
	(b) Capacitance Change: Within ±20% of Initial Value		
	(c) Dissipation Factor: Not Exceeding 150% of the Initial Specified Value		
	(d) Equivalent Series Resistance: Not Exceeding 150% of the Initial Specified Value		
	(e) Leakage Current: Not Exceeding the Initial Specified Value		
Humidity Test	After subjected to 90 to 95% RH for 1000 hours at 60°C, the capacitors shall meet the requirements as Endurance.		

## DIAGRAM OF DIMENSIONS

Dimensions: mm

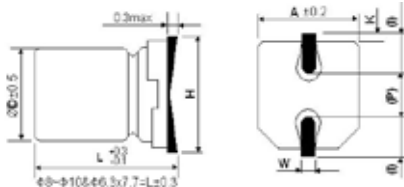

ØD	L	A	H	I	W	P	K	
6.3	5.8	6.6	7.8 Max	2.6	0.65±0.15	1.8±0.2	0.35	+0.15 -0.2
6.3	7.7	6.6	7.8 Max	2.6	0.65±0.15	1.8±0.2	0.35	+0.15 -0.2
8.0	6.7	8.3	9.5 Max	3.4	0.65±0.15	2.2±0.2	0.35	+0.15 -0.2
8.0	10.4	8.3	10.0 Max	3.4	0.90±0.2	3.1±0.2	0.70±0.20	
10.0	10.0	10.3	12.0 Max	3.5	0.90±0.2	4.6±0.2	0.70±0.20	
10.0	12.2	10.3	12.0 Max	3.5	0.90±0.2	4.6±0.2	0.70±0.20	

• Multiplier for Ripple Current

Frequency (Hz)	120 ≤ F < 1K	1K ≤ F < 10K	10K ≤ F < 100K	100K ≤ F ≤ 500K
Coefficient	0.05	0.3	0.7	1

# Conductive Polymer Aluminum Solid Electrolytic Capacitors

# VS

## ■ Dimensions, Rated Ripple Current, Equivalent Series Resistance

Capacitance (iF)	Rated Voltage							
	4V				6.3V			
	SIZE	RIPPLE	ESR	LC( $\mu$ Amax/2min)	SIZE	RIPPLE	ESR	LC( $\mu$ Amax/2min)
100					6.3x5.8	2800	22	300
120					6.3x5.8	2800	22	300
150	6.3x5.8	2570	22	300				
220					6.3x5.8	2800	20	300
					8X6.7	3220	22	300
330	6.3X5.8	2800	20	300	6.3X5.8	2800	20	415
470	6.3X7.7	2800	20	376	10X10	4130	20	592

Capacitance (iF)	Rated Voltage							
	10V				16V			
	SIZE	RIPPLE	ESR	LC( $\mu$ Amax/2min)	SIZE	RIPPLE	ESR	LC( $\mu$ Amax/2min)
22					5X5.8	1060	45	300
39					6.3x5.8	2200	30	300
47	6.3X5.8	2300	27	300				
56	6.3x5.8	2300	27	300				
68	6.3x5.8	2300	27	300	6.3x5.8	2200	30	300
120	6.3x5.8	2300	27	300				1056
330					10x12.2	3800	14	
470	8x10.4	3000	22	940				

Capacitance (iF)	Rated Voltage							
	20V							
	SIZE	RIPPLE	ESR	LC( $\mu$ Amax/2min)				
27	6.3X5.8	2450	40	300				
68								
180	10X10	3200	25	720				
470								

☆ SIZE :  $\phi$ DxL(mm) ☆tan $\delta$ :20°C,120Hz. ☆Ripple Current:(mA/rms),105°C .100KHz ☆ ESR(m $\Omega$ ).20°C.100KHz

# Conductive Polymer Solid Capacitors

# PG [ Low ESR & High Ripple Current ]

105°C, 2000 Hours and Ultra Low ESR



## DESCRIPTION

Long life for 2000 hours at 105°C, ideally suited for high quality and high reliability applications.

Featuring high CV products

## ELECTRICAL CHARACTERISTICS

Operation Temperature Range	-55 ~ +105°C		
Rated Voltage Range	2.5 ~ 50VDC		
Rated Capacitance Range	10 ~ 2200µF		
Capacitance Tolerance	± 20% at 120Hz, 20°C		
Leakage Current (Max. 20°C)	I ≤ 0.2CV (µA) ( After Rated Voltage Applied for 2 Minutes ) I = Leakage Current (µA), C = Rated Capacitance (µF), V = Rated Voltage (V)		
Dissipation Factor at 120Hz, 20°C	WV(V)	2.5 ~ 10V	16 ~ 50
	D.F (%)	8	12
Low Temperature Stability	Impedance Ratio at 20°C (Max.)		
	WV (V)	2.5 ~ 50V	
	Impedance	Z - 25°C / Z + 20°C	≤ 1.15
		Z - 55°C / Z + 20°C	≤ 1.25
Endurance	After the rated voltage has been applied at 105°C for 2000 hours, the capacitors shall meet the follow requirements.		
	(a) Appearance: No Significant Damage		
	(b) Capacitance Change: Within ±20% of Initial Value		
	(c) Dissipation Factor: Not Exceeding 150% of the Initial Specified Value		
	(d) Equivalent Series Resistance: Not Exceeding 150% of the Initial Specified Value		
	(e) Leakage Current: Not Exceeding the Initial Specified Value		
Humidity Test	After subjected to 90 to 95% RH for 1000 hours at 60°C, the capacitors shall meet the requirements as Endurance.		

## DIAGRAM OF DIMENSIONS

Dimensions: mm

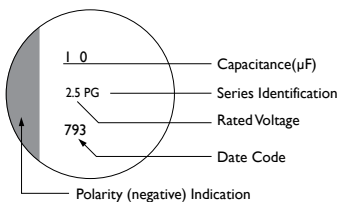

øD X L	P	ød	a
6.3X5.4	2.5	0.45	1.0
6.3X8	2.5	0.6	1.0
6.3X10.5	2.5	0.6	1.0
8X11.5	3.5	0.6	1.0
10X10.5	5.0	0.6	1.0
10X12.5	5.0	0.6	1.0

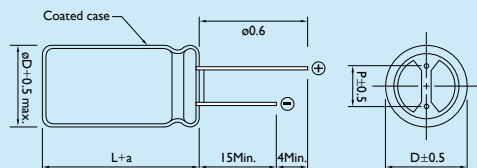

### • Multiplier for Ripple Current

Frequency (Hz)	120 ≤ F < 1K	1K ≤ F < 10K	10K ≤ F < 100K	100K ≤ F ≤ 500K
Coefficient	0.05	0.3	0.7	1

# Conductive Polymer Aluminum Solid Electrolytic Capacitors

# PG

Ultra Low ESR

■ Dimensions, Rated Ripple Current, Equivalent Series Resistance

Capacitance ( $\mu$ F)	Rated Voltage											
	2.5V				4V				6.3V			
	SIZE	RIPPLE	ESR	LC( $\mu$ A max/2min)	SIZE	RIPPLE	ESR	LC( $\mu$ A Max /2min)	SIZE	RIPPLE	ESR	LC( $\mu$ A max/2min)
47												
									6.3X5.4	1810	30	126
100									6.3X5.4	1810	40	126
120									6.3X5.4	1810	30	300
180									6.3X5.4	1810	30	300
220	6.3x5.5	2390	28	110								
									6.3X5.4	3160	18	277
270					6.3X10.5	3160	20	300	5X6	2690	15	340
330									6.3X7	2390	28	416
390	6.3x11	3160	18	195								
									5X8	3190	28	491
470									6.3X8	3190	28	592
560									6.3X8	3500	13	706
	6.3X10.5	3160	20	300	8X8	5230	10	448				
									6.3X10.5	3190	28	706
									8X11.5	4770	12	706
680	6.3X10.5	3160	20	340	6.3X10.5	3160	20	544	6.3X9	3500	8	857
	8x11	4250	10	340					6.3X10.5	4200	10	857
820	6.3X10.5	3160	20	410	6.3X10.5	3160	20	656	8X8	5500	12	1033
	8x11	5440	12	410								
1000	10x10	4700	14	500					8x8	4770	14	1260
1200						5500	12	960				
1500	10X12.5	5400	12	750								

# Conductive Polymer Aluminum Solid Electrolytic Capacitors

**PG** Ultra Low ESR

■ Dimensions, Rated Ripple Current, Equivalent Series Resistance

Capacitance (uF)	Rated Voltage											
	10V				16V				20V			
	SIZE	RIPPLE	ESR	LC( $\mu$ Amax/2min)	SIZE	RIPPLE	ESR	LC( $\mu$ Amax/2min)	SIZE	RIPPLE	ESR	LC( $\mu$ Amax/2min)
10	5X5.4	1500	45	300								
22					5X5.4	2070	45	300				
					5X7	2200	30	300				
33	5x5.4	1670	45	300	5X5.4	2070	45	300				
					6.3X5.4	2200	30	300				
47					6.3X5.4	1650	35	300				
					6.3X7	2610	25	300				
68	6.3X5.4	1810	30	300	6.3X5.4	1650	35	300	8X11.5	2980	30	300
100					5X9	2820	22	300	8X11.5	3320	30	400
	6.3X5.4	1700	27	200	6.3X8	2820	25	320				
120	6.3X5.4	2560	35	300								
150	6.3X5.4	2200	30	300	6.3X10.5	2820	25	480	10x12	4320	20	600
	6.3X10.5	2820	25	300								
180	6.3X10.5	2820	25	360	6.3X7	3800	15	576				
					6.3X10.5	2820	25	576				
					8X11.5	4360	16	576				
220	6.3X8	3640	18	704	6.3X10.5	2820	25	704				
	6.3X10.5	2820	25	440	8X11.5	5000	11	704				
270					6.3X10.5	3100	20	864				
					8X11.5	5000	11	864				
					10X10.5	5050	14	864				
330	6.3X10.5	2820	25	660	6.3X10.5	3100	20	1056				
					8X11	4360	16	1056	10x12	2800	24	1320
390												
					10X12.5	6100	10	1248				
470	6.3X10.5	2820	25	940	8X11.5	5000	11	1504				
560	8X8	5300	12	1360	8X11.5	5000	11	1792				
	10X12.5	6100	12	1120	10X10.5	5050	10	1792				
1000	8X11	5230	13	2000	10X12.6	4800	12	3200				

Capacitance (uF)	Rated Voltage											
	25V				35V				50V			
	SIZE	RIPPLE	ESR	LC( $\mu$ Amax/2min)	SIZE	RIPPLE	ESR	LC( $\mu$ Amax/2min)	SIZE	RIPPLE	ESR	LC( $\mu$ Amax/2min)
10	6.3X8	1200	80	300								
22					8X11	2300	31	154				
33	8X11.5	3320	24	165								
47	6.3X10.5	1980	35	300	10x12	3650	30	329	10x12	2600	28	680
	8X11.5	2980	30	300								
56	6.3X10.5	1980	35	280								
	8X11.5	2980	24	280								
68	8X11.5	3320	24	340	10x12	2700	28	476				
100	8X11.5	2980	30	500								
	10X10.5	2980	30	500								
	10X12.5	4320	20	500								
150	10X12.5	4320	30	750	10x12.5	2700	26	1050				
270	10x12	2800	25	1350	10x12.5	2400	30	1890				

SIZE :  $\phi$ DxL(mm) ☆tan $\delta$ :20°C,120Hz. ☆Ripple Current:(mA/rms),105°C .100KHz ☆ ESR(m $\Omega$ ),20°C.100KHz

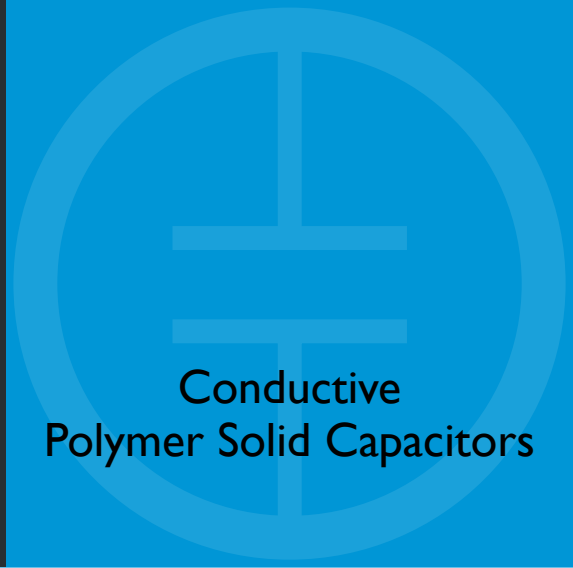

# PP [ 8mm Height ]

105°C, 2000 Hours 8mm Height and Ultra Low ESR

## Conductive Polymer Solid Capacitors

### ELECTRICAL CHARACTERISTICS

Operation Temperature Range	-55 ~ +105°C
Rated Voltage Range	2.5 ~ 25V
Rated Capacitance Range	10 ~ 1200μF
Capacitance Tolerance	± 20% at 120Hz, 20°C
Leakage Current (Max. 20°C)	$I \leq 0.2CV$ (μA) ( After Rated Voltage Applied for 2 Minutes ) I = Leakage Current (μA), C = Rated Capacitance (μF), V = Rated Voltage (V)
Dissipation Factor at 120Hz, 20°C	WV(V)            2.5 ~ 25V ----- D.F (%)            8
Low Temperature Stability	Impedance Ratio at 20°C (Max.) WV (V)    2.5 ~ 25V (Rated Voltage) ----- Impedance    Z - 25°C / Z + 20°C    ≤ 1.15 Z - 55°C / Z + 20°C    ≤ 1.25
Endurance	After the rated voltage has been applied at 105°C for 2000 hours, the capacitors shall meet the follow requirements. (a) Appearance: No Significant Damage (b) Capacitance Change: Within ±20% of the Initial Value (c) Dissipation Factor: Not Exceeding 150% of the Initial Specified Value (d) Equivalent Series Resistance: Not Exceeding 150% of the Initial Specified Value (e) Leakage Current: Not more than the Initial Specified Value
Humidity Test	After subjected 90 to 95% RH for 1000 hours at 60°C, the capacitors shall meet the requirements as Endurance.



### DESCRIPTION

Recommended Applications: Motherboard, DC / DC Converter, DSC, PDA, HD Drive, MO Drive, DVD Drive, Navigation system, Portable Communication Devices

### DIAGRAM OF DIMENSIONS

Dimensions: mm

#### Rubber Stand-off

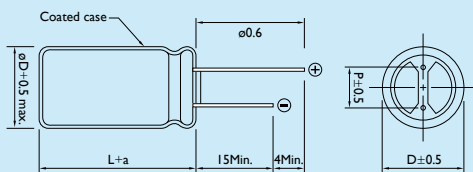

Dø	P	a (Max.)
6.3 × 8	2.5	1.0
8 × 8	3.5	1.5

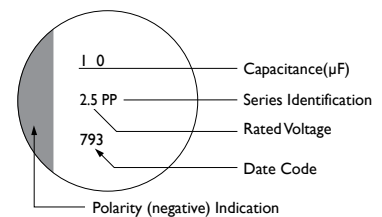

# Conductive Polymer Aluminum Solid Electrolytic Capacitors

# PP

8 mm Height

## ■ Dimensions, Rated Ripple Current, Equivalent Series Resistance

Capacitance (uF)	Rated Voltage											
	2.5V				4V				6.3V			
	SIZE	RIPPLE	ESR	LC( $\mu$ Amax/2min)	SIZE	RIPPLE	ESR	LC( $\mu$ Amax/2min)	SIZE	RIPPLE	ESR	LC( $\mu$ Amax/2min)
470					8x8	5600	7	470	6.3x8	4200	8	592
									8x8	5600	8	592
560	6.3x8	4200	6	300	6.3x8	4200	7	448	6.3x8	4200	8	706
	8x8	5600	6	300	8x8	5600	7	448	8x8	5600	8	706
820	6.3x8	4200	6	410					8x8	5600	8	1033
	8x8	5600	6	410								
1000	8x8	6100	7	500					8x8	5600	8	1260
1200	8x8	5600	6	600	8x8	5600	7	960				

Capacitance (uF)	Rated Voltage											
	10V				16V				25V			
	SIZE	RIPPLE	ESR	LC( $\mu$ Amax/2min)	SIZE	RIPPLE	ESR	LC( $\mu$ Amax/2min)	SIZE	RIPPLE	ESR	LC( $\mu$ Amax/2min)
10									6.3x8	1200	80	300
22									6.3x8	1650	35	300
33									6.3x8	1650	35	300
									8x8	1980	35	300
47									8x8	1980	35	300
56									8x8	1980	35	300
100					6.3x8	2820	10	500				
150	6.3x8	2820	25	300								
					8x8	2820	25	480				
180	6.3x8	2820	25	360	6.3x8	4680	10	576	8x8	3770	18	900
					8x8	5000	10	576				
220	6.3x8	2820	25	440	6.3x8	2820	25	704				
	8x8	3500	11	440	8x8	3500	11	704				
270	6.3x8	2820	25	540	8x8	5000	10	864				
330	6.3x8	2820	25	660	8x8	3500	11	1056				
	8x8	3500	11	660	8x8	5000	10	1056				
470	8x8	3500	11	940								
560	8x8	5000	10	1120								

☆ SIZE :  $\phi$ DxL(mm) ☆tan $\delta$ :20°C,120Hz. ☆Ripple Current:(mA/rms),105°C .100KHz ☆ ESR(m $\Omega$ ),20°C.100KHz

# PR [ High Ripple Current & Ultra Low ESR ]

105°C, 2000 Hours, 2.5~16V Super Low ESR 7~8mΩ

## Conductive Polymer Solid Capacitors

### ELECTRICAL CHARACTERISTICS

Operation Temperature Range	-55 ~ +105°C		
Rated Voltage Range	2.5 ~ 16VDC		
Rated Capacitance Range	270 ~ 2700μF		
Capacitance Tolerance	± 20% at 120Hz, 20°C		
Leakage Current (Max. 20°C)	I ≤ 0.2CV (μA) ( After Rated Voltage Applied for 2 Minutes ) I = Leakage Current (μA), C = Rated Capacitance (μF), V = Rated Voltage (V)		
Dissipation Factor at 120Hz, 20°C	WV(V)	2.5 ~ 16V	
	D.F (%)	8	
Low Temperature Stability	Impedance Ratio at 20°C (Max.)		
	WV (V)	2.5 ~ 16V (Rated Voltage)	
	Impedance	Z - 25°C / Z + 20°C	≤ 1.15
		Z - 55°C / Z + 20°C	≤ 1.25
Endurance	After the rated voltage has been applied at 105°C for 2000 hours, the capacitors shall meet the follow requirements. (a) Appearance: No Significant Damage (b) Capacitance Change: Within ±20% of the Initial Value (c) Dissipation Factor: Not Exceeding 150% of the Initial Specified Value (d) Equivalent Series Resistance: Not Exceeding 150% of the Initial Specified Value (e) Leakage Current: Not more than the Initial Specified Value		
Humidity Test	After subjected 90 to 95% RH for 1000 hours at 60°C, the capacitors shall meet the requirements as Endurance.		



### DESCRIPTION

Recommended Applications: Motherboard, DC / DC Converter; DSC, PDA, HD Drive, MO Drive, DVD Drive, Navigation system, Portable Communication Devices

### DIAGRAM OF DIMENSIONS

Dimensions: mm

#### Rubber Stand-off

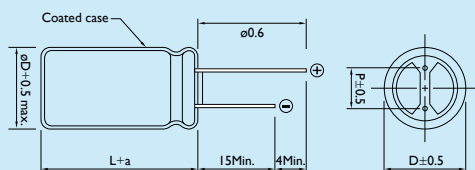

øD X L	P	ød	a
6.3x8	2.5	0.6	1.0
8x8	3.5	0.6	1.5
8x11.5	3.5	0.6	1.0
10x12.5	5.0	0.6	1.0

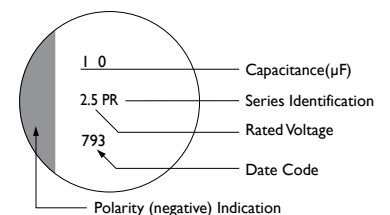



# ORGANIC CONDUCTIVE POLYMER CAPACITORS

# PR

High ripple & low ESR Series

## ■ Dimensions, Rated Ripple Current, Equivalent Series Resistance

Capacitance (uF)	Rated Voltage											
	2.5V				4V				6.3V			
	SIZE	RIPPLE	ESR	LC(μAmax/2min)	SIZE	RIPPLE	ESR	LC(μAmax/2min)	SIZE	RIPPLE	ESR	LC(μAmax/2min)
270									6.3X8	4700	7	340
330	6.3X8	5600	7	500					6.3X8	4700	7	416
390									5X8	4700	7	491
470					8X8	5600	7	470	6.3X8	5700	7	592
	8X8	5000	7	230								
560	6.3X8	5000	7	300	6.3X8	5000	7	448	6.3X8	4700	7	706
	8X8	6100	7	300	8X8	6100	7	448	8X8	5700	7	706
680	8X8	6100	7	340	8X8	6100	7	544	6.3X8	4700	7	857
	8X11.5	6100	7	340					8x8	5700	7	857
	6x8	4800	8	500								
820	6.3X8	5000	7	410	8X8	6100	7	656	8X7	5700	7	1033
	8X8	6100	7	410	10x12	6100	7	656				
	8X11.5	6100	7	410					8X11.5	5700	7	1033
1000	8X8	6100	7	500	8X8	6100	7	800	8X8	5700	7	1260
	8X11.5	6100	7	500	8X11.5	6100	7	800	8X11.5	5700	7	1260
					10X12.5	6100	7	800				
1200	8X8	6100	7	600	8X8	6100	7	960	8X11.5	5700	7	1512
	8X11.5	6100	7	600	8X11.5	6100	7	960				
1500	8X11.5	6100	7	750	8X11.5	6100	7	1200	8X11.5	5700	7	1890
									10X12.5	5560	7	1890
1800					8X11.5	6500	9	1440				
2700	10X12.5	5560	8	1350								

Capacitance (uF)	Rated Voltage							
	10V				16V			
	SIZE	RIPPLE	ESR	LC (μAmax/2min)	SIZE	RIPPLE	ESR	LC (μAmax/2min)
270	6.3x8	4700	7	540	8x9	5080	7	882
330	6.3x8	4700	7	660	8x11.5	5600	7	1056
390	8x12	5000	7	780				
470	10x12	6000	7	940	8x12	5600	7	1500
560	8x8	5700	7	1120				
820	8x11.5	5700	7	1640	10x12	6000	8	1500
1000					10x12	6100	8	3200

☆ SIZE : øDxL(mm) ☆tanδ:20°C,120Hz. ☆Ripple Current:(mA/rms),105°C.100KHz ☆ ESR(mΩ).20°C.100KHz

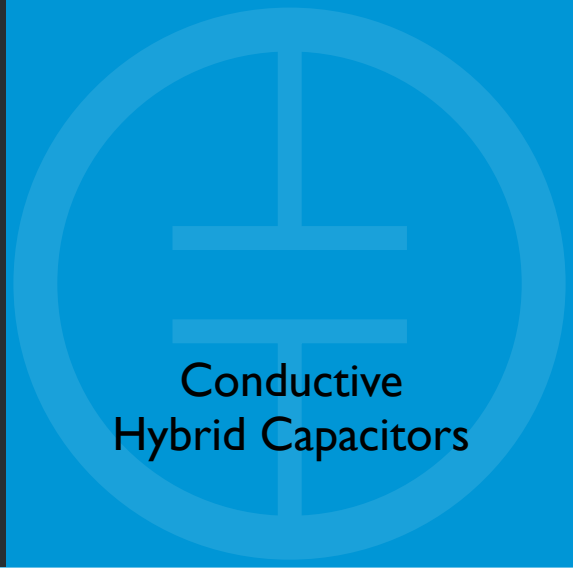

# PS [ Polymer Hybrid ]

Endurance 5000 hrs at 105°C

## Conductive Hybrid Capacitors

### ELECTRICAL CHARACTERISTICS

Operation Temperature Range	-55 ~ +105°C		
Rated Voltage Range	35 ~ 100V		
Rated Capacitance Range	10 ~ 560μF		
Capacitance Tolerance	± 20% at 120Hz, 20°C		
Leakage Current (Max. 20°C)	I ≤ 0.2CV (μA) ( After Rated Voltage Applied for 2 Minutes ) I = Leakage Current (μA), C = Rated Capacitance (μF), V = Rated Voltage (V)		
Dissipation Factor at 120Hz, 20°C	WV(V)	35 ~ 100V	
	DF (%)	10	
Low Temperature Stability	Impedance Ratio at 20°C (Max.)		
	Impedance	Z - 25°C / Z + 20°C	≤ 1.15
		Z - 55°C / Z + 20°C	≤ 1.25
Endurance	After the rated voltage has been applied at 105°C for 5000 hours, the capacitors shall meet the follow requirements.		
	(a) Appearance: No Significant Damage		
	(b) Capacitance Change: Within ±20% of the Initial Value		
	(c) Dissipation Factor: Not Exceeding 150% of the Initial Specified Value		
	(d) Equivalent Series Resistance: Not Exceeding 150% of the Initial Specified Value		
	(e) Leakage Current: Not more than the Initial Specified Value		
Humidity Test	After subjected 90 to 95% RH for 1000 hours at 60°C, the capacitors shall meet the requirements as Endurance.		



### DESCRIPTION

Recommended Applications: Montherboard, DC / DC Converter; DSC, PDA, HD Drive, MO Drive, DVD Drive, Navigation system, Portable Communication Devices

Long Life for 5000 hours at 105°C, high reliability application.

5000 hrs at 105°C

Low profile, high reliability with high voltage and safety critical

Low DC leakage current

RoHS Compliant

### DIAGRAM OF DIMENSIONS

Dimensions: mm

#### Rubber Stand-off

øD X L	P	ød	a
8X8	3.5	0.6	1.0
8X11.5	3.5	0.6	1.0
10X12.5	5.0	0.6	1.0
10X16	5.0	0.6	1.0

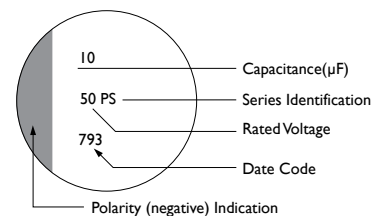
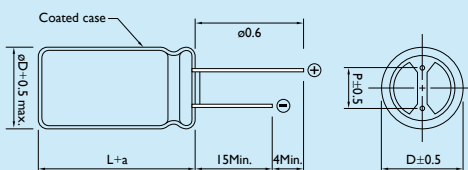

#### • Multiplier for Ripple Current

Frequency (Hz)	120 ≤ F < 1K	1K ≤ F < 10K	10K ≤ F < 100K	100K ≤ F ≤ 500K
Coefficient	0.05	0.3	0.7	1



# Conductive Polymer Solid Capacitors

## PH [ Long Life & Ultra Low ESR ]

105°C, 5000 Hours and Ultra Low ESR

### ELECTRICAL CHARACTERISTICS

Operation Temperature Range	-55 ~ +105°C		
Rated Voltage Range	2.5 ~ 50V		
Rated Capacitance Range	100 ~ 2200μF		
Capacitance Tolerance	± 20% at 120Hz, 20°C		
Leakage Current (Max. 20°C)	I ≤ 0.2CV (μA) ( After Rated Voltage Applied for 2 Minutes ) I = Leakage Current (μA), C = Rated Capacitance (μF), V = Rated Voltage (V)		
Dissipation Factor at 120Hz, 20°C	WV(V)	2.5 ~ 50V	
	DF (%)	12	
Low Temperature Stability	Impedance Ratio at 20°C (Max.)		
	WV (V)	2.5 ~ 50V (Rated Voltage)	
	Impedance	Z - 25°C / Z + 20°C	≤ 1.15
		Z - 55°C / Z + 20°C	≤ 1.25
Endurance	After the rated voltage has been applied at 105°C for 5000 hours, the capacitors shall meet the follow requirements.		
	(a) Appearance: No Significant Damage		
	(b) Capacitance Change: Within ±20% of the Initial Value		
	(c) Dissipation Factor: Not Exceeding 150% of the Initial Specified Value		
	(d) Equivalent Series Resistance: Not Exceeding 150% of the Initial Specified Value		
	(e) Leakage Current: Not more than the Initial Specified Value		
Humidity Test	After subjected 90 to 95% RH for 1000 hours at 60°C, the capacitors shall meet the requirements as Endurance.		

### DIAGRAM OF DIMENSIONS

Dimensions: mm

Rubber Stand-off

∅D X L	P	∅d	a
5X9	2.0	0.5	1.0
6.3X5.4	2.5	0.45	1.0
6.3X8	2.5	0.6	1.0
8X11.5	3.5	0.6	1.0
10X12.5	5.0	0.6	1.0

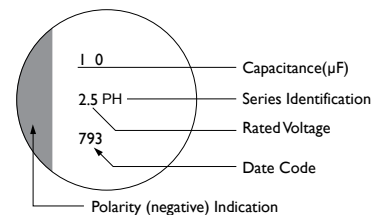
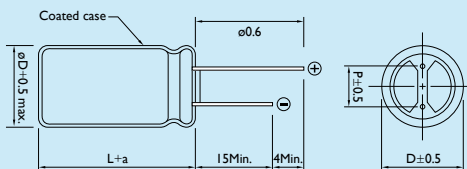

• Multiplier for Ripple Current

Frequency (Hz)	120 ≤ F < 1K	1K ≤ F < 10K	10K ≤ F < 100K	100K ≤ F ≤ 500K
Coefficient	0.05	0.3	0.7	1



### DESCRIPTION

Recommended Applications: Motherboard, DC / DC Converter; DSC, PDA, HD Drive, MO Drive, DVD Drive, Navigation system, Portable Communication Devices

Long Life for 5000 hours at 105°C, high reliability application.

Super Low ESR at a high frequency range.

High ripple current capability.

5000 hrs at 105°C

RoHS Compliant

# Conductive Polymer Aluminum Solid Electrolytic Capacitors

**PH** Long life & Ultra low ESR

■ Dimensions, Rated Ripple Current, Equivalent Series Resistance

Capacitance (uF)	Rated Voltage															
	2.5V				4V				6.3V				10V			
	SIZE	RIPPLE	ESR	LC (uAmax/2min)	SIZE	RIPPLE	ESR	LC (uAmax/2min)	SIZE	RIPPLE	ESR	LC (uAmax/2min)	SIZE	RIPPLE	ESR	LC (uAmax/2min)
100									6.3X5.4	2320	30	300				
220									6.3X5.4	1700	45	300				
330	6.3X8	3500	7	300					6.3X8	3500	7	416	8x11.5	3500	10	660
390	6.3X5.4	4200	10	500												
470	6.3X9	5400	7	235	6.3X9	5400	7	376	6.3x8	3500	7	592				
									8X8	3500	7	592				
560	5X9	4350	7	300	6.3x8	5000	7	448	6.3x8	3500	7	706	8X11.5	5000	10	1120
	6.3X5.4	3000	16	300	8X8	6100	7	448	8X8	3500	7	706				
	6.3x8	3500	7	300												
680									6.3X10.5	2400	10	857	8X8	3500	10	1360
820	6.3x8	3500	7	410	8X8	6100	7	656	8X8	3500	8	1033	6.3X8	4700	8	1033
	8X8	3500	7	410					6.3X8	4700	8	1033				
860									8X11.5	3500	7	1084				
1000	8X8	6100	7	910	8X8	6100	7	800								
1200									8x11.5	3500	7	1512				
1500									10x12.5	3500	7	1890				
1800									10x12.5	3500	7	2268				

Capacitance (uF)	Rated Voltage															
	16V				25V				35V				50V			
	SIZE	RIPPLE	ESR	LC (uAmax/2min)	SIZE	RIPPLE	ESR	LC (uAmax/2min)	SIZE	RIPPLE	ESR	LC (uAmax/2min)	SIZE	RIPPLE	ESR	LC (uAmax/2min)
33									8X8	2800	30	300				
39									8X8	1500	29	300				
56					6.3X5	2800	30	300	8X8	1500	29	392	8X11.5	1760	25	560
68																
82					8X8	3000	28	410	8X11	4000	20	570	10X12.5	2050	25	820
100	6.3X5.4	2490	24	320	8X12	3900	24	500	8X8	1500	29	700	10X12.5	2050	25	1000
	6.3X8	2490	35	320												
120									8X11.5	1760	25	840				
									10X12.5	2050	18	840				
150					8X11.5	1760	25	750	8X11.5	1760	25	1050				
180	6.3X8	2490	25	576												
220	8X11.5	3000	10	704	8X11.5	1760	25	1100								
270	6.3X8	3800	15	864	8X11.5	1760	25	1350	10X12.5	2050	25	1890				
	8X8	3500	10	864												
	8x11.5	3500	10	864												
330	8X8	3500	10	1056	10X12.5	2050	25	1650								
					10X12.5	2050	25	1950								
470	8x11.5	3500	10	1504	10X12.5	2050	25	2350								
	10X12.5	6100	9	1504												
560	8X11.5	3500	10	1792												
680	8X15	3500	11	2176												
820	10x12.5	4000	11	2624												
1000	10X12.5	6000	10	3200												
2200	10X20	6100	8	7040												

\* Size : øDxL(mm) \* tanδ : 20°C,120Hz. \* Ripple Current : (mA/rms),105°C .100KHz \* ESR(mΩ),20°C.100KHz

# Conductive Polymer Solid Capacitors

## PT [ High Temperature ]

125°C, 1000~2000 hours and Low ESR

### ELECTRICAL CHARACTERISTICS

Operation Temperature Range	-55 ~ +105°C			
Rated Voltage Range	2.5 ~ 25VDC			
Rated Capacitance Range	10 ~ 1200µF			
Capacitance Tolerance	± 20% at 120Hz, 20°C			
Leakage Current (Max. 20°C)	$I \leq 0.2CV$ (µA) ( After Rated Voltage Applied for 2 Minutes ) I = Leakage Current (µA), C = Rated Capacitance (µF), V = Rated Voltage (V)			
Dissipation Factor at 120Hz, 20°C	WV(V)	2.5 ~ 25V		
	D.F (%)	12		
Low Temperature Stability	Impedance Ratio at 20°C (Max.)			
	WV (V)	2.5 ~ 25V		
	Impedance	Z - 25°C / Z + 20°C	≤ 1.15	
		Z - 55°C / Z + 20°C	≤ 1.25	
Endurance	After the rated voltage has been applied at 125°C for 2000 hours (1000hrs for 2.5~4V), the capacitors shall meet the follow requirements.			
	(a) Appearance: No Significant Damage			
	(b) Capacitance Change: Within ±20% of Initial Value			
	(c) Dissipation Factor: Not Exceeding 150% of the Initial Specified Value			
	(d) Equivalent Series Resistance: Not Exceeding 150% of the Initial Specified Value			
	(e) Leakage Current: Not Exceeding the Initial Specified Value			
Humidity Test	After subjected to 90 to 95% RH for 1000 hours at 60°C, the capacitors shall meet the requirements as Endurance.			



### DESCRIPTION

Long life for 2000 hours at 125°C, ideally suited for high quality and high reliability applications.

Featuring high CV products

### DIAGRAM OF DIMENSIONS

Dimensions: mm

øD X L	P	ød	a
6.3X8	2.5	0.6	1.0
8X8	3.5	0.6	1.5
8X11.5	3.5	0.6	1.0
10X12.5	5	0.6	1.0

#### Rubber Stand-off

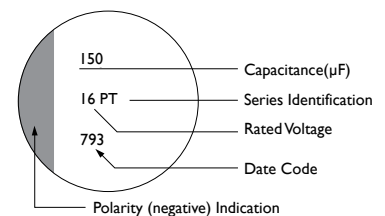
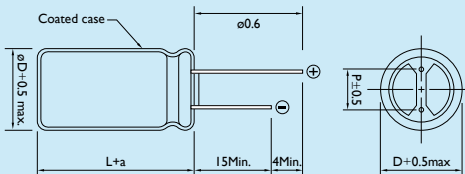

#### • Multiplier for Ripple Current

Frequency (Hz)	120 ≤ F < 1K	1K ≤ F < 10K	10K ≤ F < 100K	100K ≤ F ≤ 500K
Coefficient	0.05	0.3	0.7	1

# Conductive Polymer Aluminum Solid Electrolytic Capacitors

## ■ Dimensions, Rated Ripple Current, Equivalent Series Resistance

Capacitance (uF)	Rated Voltage									
	2.5V					4V				
	SIZE	RIPPLE		ESR	LC(iA)(max) after 2mins	SIZE	RIPPLE		ESR	LC(iA)(max) after 2mins
Tx : 125°C		T0 : 105°C	Tx : 125°C				T0 : 105°C			
560						8x11	1430	4520	13	440
680	8x11	1430	4520	13	340	8x11	1430	4520	13	540
820	8x11	1430	4520	13	410					
1200	10x12	1720	5400	13	600	10x12	1720	5440	12	960

Capacitance (uF)	Rated Voltage									
	6.3V					10V				
	SIZE	RIPPLE		ESR	LC(iA)(max) after 2mins	SIZE	RIPPLE		ESR	LC(iA)(max) after 2mins
Tx : 125°C		T0 : 105°C	Tx : 125°C				T0 : 105°C			
330						8X11.5	1250	3950	17	660
470						10X12.5	1655	5230	13	705
	8X11.5	1332	4210	15	592					
560	8X11.5	1332	4210	15	706	10X12.5	1655	5230	13	840
680	10X12.5	1721	5440	12	643	10X12.5	1655	5230	13	1020
820	10X12.5	1721	5440	12	775					
1000	10X12.5	1721	5440	12	945	10X12.5	1200	5230	13	2000
1200	10X12.5	1720	5440	12	960					

Capacitance (uF)	Rated Voltage									
	16V					20V				
	SIZE	RIPPLE		ESR	LC(iA)(max) after 2mins	SIZE	RIPPLE		ESR	LC(iA)(max) after 2mins
Tx : 125°C		T0 : 105°C	Tx : 125°C				T0 : 105°C			
82						8X11.5	1050	3320	24	328
100						8X11.5	1050	3320	24	400
120						10X12.5	1367	4320	20	480
										480
150	8X8	670	2120	40	480	10X12.5	1367	4320	20	600
180	8X11.5	1151	3640	20	576					
220	8X11.5	1151	3640	20	704					
270	10X12.5	1493	4720	16	648					
330	8X11.5	1150	3630	20	1056					
	10X12.5	1493	4720	16	792					
470	10X12.5	1493	4720	16	1504					
1200	10X16	1890	6000	12	3840					

Capacitance (uF)	Rated Voltage				
	25V				
	SIZE	RIPPLE		ESR	LC(iA)(max) after 2mins
Tx : 125°C		T0 : 105°C			
68	8X11.5	1050	3320	24	340
82	8X11.5	1050	3320	24	410
100	8X11.5	1050	3320	24	500
	10X12.5	1367	4320	20	500
120	10X12.5	1367	4320	20	600
150	10X12.5	1367	4320	20	750
220	8X11.5	1050	3320	24	1100
270	8X15	1367	4320	20	1350

☆ Tx : Ambient temperature ☆ SIZE : øDxL(mm) ☆ tanδ:20°C,120Hz. ☆ Ripple Current:(mA/rms),105°C .100KHz ☆ ESR(mΩ).20°C.100KHz

# Screw Type Aluminum Electrolytic Capacitors

## NP [ For General ]

85°C 2000 Hours, For Large Power Source, Converter Circuit



### DESCRIPTION

Endurance : 85°C, 2000 Hours

It is suitable for high ripple current, large power source, converter circuit, etc.

### MULTIPLIER FOR RIPPLE CURRENT

Frequency Coefficient

FREQUENCY (Hz)	50	100 (120)	300	1K
10~50V	0.95	1.00	1.04	1.10
63~100V	0.95	1.00	1.06	1.16
160~200V	0.90	1.00	1.10	1.20
250~450V	0.80	1.00	1.10	1.20

FREQUENCY (Hz)	3K	5K	10K	20K
10~50V	1.12	1.13	1.15	1.15
63~100V	1.20	1.25	1.30	1.36
160~200V	1.35	1.40	1.50	1.55
250~450V	1.35	1.40	1.50	1.55

### ELECTRICAL CHARACTERISTICS

Operating Temperature Range	-40 to +85°C	-25 to +85°C
Rated Voltage Range	10 ~ 250V	315 ~ 450V
Rated Capacitance Range	1800 ~ 820000μF	
Capacitance Tolerance	±20% (120Hz, +20°C)	
Leakage Current	I = 0.02CV or 5mA whichever is smaller: (After 5 Minutes Application of DC Rated Voltage at 20°C)	
Dissipation Factor at 120Hz, +20°C	Less than the Value Specified in the Standard Product Tables	
Endurance	After the rated voltage has been applied at 85°C for 2000 hours, and then has resumed its original condition for 16 hours. (a) Capacitance Change: ±20% Initial Measured Value (b) Dissipation Factor: ≤ 2 Times Initial Specified Value (c) Leakage Current: ≤ Initial Specified Value	
Shelf Life	After having been stored for 1000 hours at 85°C, the rated voltage has been applied for 30 minutes, and then has resumed its original condition for 16 hours. (a) Capacitance Change: ±20% Initial Measured Value (b) Dissipation Factor: ≤ 2 Times Initial Specified Value (c) Leakage Current: ≤ Initial Specified Value	

### DIAGRAM OF DIMENSIONS

Unit: mm

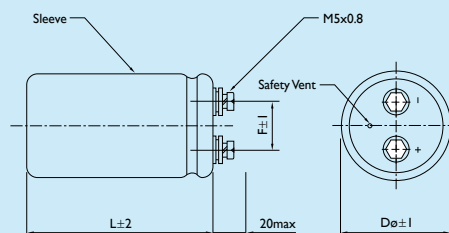

Dø	F
35	12.7
51	22
63.5	28.6
76	32
89	32



## CASE SIZE & PERMISSIBLE RIPPLE CURRENT OF STANDARD PRODUCTS

D x L: mm

CAP. ( $\mu$ F)	RATED VOLTAGE WV (SURGE VOLTAGE WV)											
	10 (13)			16 (20)			25 (32)			35 (44)		
	SIZE	RIPPLE CURRENT	DISSIPATION FACTOR	SIZE	RIPPLE CURRENT	DISSIPATION FACTOR	SIZE	RIPPLE CURRENT	DISSIPATION FACTOR	SIZE	RIPPLE CURRENT	DISSIPATION FACTOR
10000										35 x 50	3.40	0.40
12000										35 x 50	3.70	0.40
15000							35 x 50	3.70	0.50	35 x 65	4.20	0.40
18000							35 x 50	4.10	0.50	35 x 80	4.90	0.40
22000				35 x 50	4.10	0.60	35 x 50	4.50	0.50	35 x 80	5.70	0.40
27000				35 x 50	4.50	0.60	35 x 65	5.00	0.50	35 x 100	6.30	0.40
33000	35 x 50	4.30	0.80	35 x 50	5.00	0.60	35 x 80	5.90	0.50	35 x 100	7.20	0.40
39000	35 x 50	4.70	0.80	35 x 65	5.90	0.60	35 x 80	6.70	0.50	35 x 120	7.30	0.50
47000	35 x 65	5.20	0.80	35 x 80	6.40	0.60	35 x 100	7.70	0.50	35 x 120	8.70	0.50
56000	35 x 80	6.10	0.80	35 x 80	7.30	0.60	35 x 100	7.90	0.60	51 x 95	8.60	0.60
68000	35 x 80	6.70	0.80	35 x 100	8.40	0.60	35 x 120	9.10	0.60	51 x 95	9.80	0.60
82000	35 x 100	7.70	0.80	35 x 100	8.30	0.80	35 x 120	10.40	0.60	51 x 115	11.60	0.60
100000	35 x 100	8.80	0.80	35 x 120	9.50	0.80	51 x 95	10.30	0.80	63.5 x 95	13.30	0.60
120000	35 x 120	10.00	0.80	35 x 120	10.90	0.80	51 x 115	11.70	0.80	63.5 x 115	14.80	0.60
150000	35 x 120	10.80	1.00	51 x 95	11.30	1.00	51 x 130	14.10	0.80	63.5 x 120	14.90	0.80
180000	51 x 95	12.00	1.00	51 x 115	12.80	1.00	63.5 x 95	15.70	0.80	63.5 x 130	17.00	0.80
220000	51 x 120	11.20	1.50	51 x 130	15.30	1.00	63.5 x 115	16.10	1.00	76 x 115	20.00	0.80
270000	51 x 120	12.80	1.50	63.5 x 95	17.60	1.00	63.5 x 130	18.60	1.00	76 x 130	20.30	1.00
330000	63.5 x 95	15.30	1.50	63.5 x 115	16.80	1.50	63.5 x 155	21.90	1.00	76 x 155	23.50	1.00
390000	63.5 x 115	17.30	1.50	63.5 x 130	18.30	1.50	76 x 120	22.00	1.20	89 x 130	26.40	1.00
470000	63.5 x 130	16.70	2.00	76 x 120	21.30	1.50	76 x 155	25.60	1.20	89 x 155	29.60	1.00
560000	76 x 115	19.00	2.00	76 x 130	23.60	1.50	89 x 130	27.90	1.20			
680000	76 x 130	21.70	2.00	76 x 155	27.60	1.50	89 x 155	32.50	1.20			
820000	76 x 155	24.70	2.00	89 x 155	27.10	2.00						

Note: 1. Ripple Current: (A/rms) 85°C, 120Hz

2. Dissipation Factor: 120Hz / 20°C

## CASE SIZE & PERMISSIBLE RIPPLE CURRENT OF STANDARD PRODUCTS

D x L: mm

CAP. (μF)	RATED VOLTAGE WV (SURGE VOLTAGE WV)											
	50 (63)			63 (72)			80 (100)			100 (125)		
	SIZE	RIPPLE CURRENT	DISSIPATION FACTOR	SIZE	RIPPLE CURRENT	DISSIPATION FACTOR	SIZE	RIPPLE CURRENT	DISSIPATION FACTOR	SIZE	RIPPLE CURRENT	DISSIPATION FACTOR
1800										35 x 50	1.90	0.25
2200										35 x 50	2.10	0.25
2700										35 x 50	2.30	0.25
3300							35 x 50	2.50	0.25	35 x 65	2.60	0.25
3900				35 x 50	2.70	0.25	35 x 50	2.80	0.25	35 x 80	3.00	0.25
4700				35 x 50	3.00	0.25	35 x 65	3.00	0.25	35 x 80	3.50	0.25
5600	35 x 50	3.00	0.30	35 x 50	3.30	0.25	35 x 80	3.60	0.25	35 x 100	3.90	0.25
6800	35 x 50	3.30	0.30	35 x 65	3.60	0.25	35 x 80	3.90	0.25	35 x 100	4.50	0.25
8200	35 x 50	3.60	0.30	35 x 80	4.30	0.25	35 x 80	4.50	0.25	35 x 120	5.10	0.25
10000	35 x 65	4.00	0.30	35 x 80	4.90	0.25	35 x 100	5.20	0.25	35 x 120	5.90	0.25
12000	35 x 80	4.70	0.30	35 x 100	5.60	0.25	35 x 100	5.90	0.25	51 x 75	6.40	0.25
15000	35 x 80	5.50	0.30	35 x 100	5.90	0.30	35 x 120	6.80	0.25	51 x 95	7.00	0.25
18000	35 x 100	6.20	0.30	35 x 120	6.70	0.30	35 x 120	7.80	0.25	51 x 115	8.30	0.25
22000	35 x 120	6.30	0.40	35 x 120	7.80	0.30	51 x 95	8.00	0.30	51 x 130	10.00	0.25
27000	35 x 120	7.10	0.40	51 x 95	7.40	0.40	51 x 95	9.20	0.30	63.5 x 115	11.50	0.25
33000	51 x 95	8.20	0.40	51 x 95	8.40	0.40	51 x 115	10.50	0.30	63.5 x 130	11.90	0.25
39000	51 x 95	8.10	0.50	51 x 115	9.50	0.40	51 x 130	12.00	0.30	76 x 115	13.40	0.25
47000	51 x 115	9.30	0.50	51 x 130	11.30	0.40	63.5 x 115	13.60	0.30	76 x 130	14.20	0.35
56000	63.5 x 95	10.50	0.50	63.5 x 115	12.80	0.40	63.5 x 130	13.40	0.40	76 x 155	16.00	0.35
68000	63.5 x 95	12.00	0.50	63.5 x 120	12.70	0.50	76 x 115	15.40	0.40	89 x 130	18.80	0.35
82000	63.5 x 115	13.70	0.50	63.5 x 130	14.50	0.50	76 x 130	17.50	0.40	89 x 155	20.50	0.35
100000	76 x 115	14.70	0.60	76 x 115	16.70	0.50	76 x 155	20.50	0.40	89 x 171	24.00	0.35
120000	76 x 120	16.70	0.60	76 x 130	18.90	0.50	89 x 130	22.70	0.40			
150000	76 x 130	19.30	0.60	76 x 155	22.40	0.50	89 x 155	26.50	0.40			
180000	76 x 155	21.90	0.60	89 x 130	22.40	0.60						
220000	89 x 130	21.40	0.60	89 x 155	26.20	0.60						
270000	89 x 155	24.60	0.60									

Note: 1. Ripple Current: (A/rms) 85°C, 120Hz  
 2. Dissipation Factor: 120Hz / 20°C

## CASE SIZE & PERMISSIBLE RIPPLE CURRENT OF STANDARD PRODUCTS

D x L: mm

CAP. (μF)	RATED VOLTAGE WV (SURGE VOLTAGE WV)											
	160 (200)			200 (250)			250 (300)			350 (400)		
	SIZE	RIPPLE CURRENT	DISSIPATION FACTOR	SIZE	RIPPLE CURRENT	DISSIPATION FACTOR	SIZE	RIPPLE CURRENT	DISSIPATION FACTOR	SIZE	RIPPLE CURRENT	DISSIPATION FACTOR
390										35 x 50	1.67	0.20
470										35 x 80	2.15	0.20
560										35 x 80	2.37	0.20
680										35 x 80	2.59	0.20
820										35 x 100	3.07	0.20
1000										35 x 100	3.41	0.20
1200										51 x 75	3.81	0.20
1500							35 x 100	3.22	0.25	51 x 75	4.26	0.20
1800							35 x 100	3.52	0.25	51 x 95	5.14	0.20
2200				35 x 100	3.92	0.25	51 x 75	4.00	0.25	51 x 95	5.70	0.20
2700				35 x 120	4.70	0.25	51 x 75	4.44	0.25	51 x 130	7.14	0.20
3300	35 x 120	5.18	0.25	51 x 75	4.92	0.25	51 x 95	5.40	0.25	51 x 130	7.92	0.20
3900	51 x 75	5.33	0.25	51 x 75	5.33	0.25	51 x 115	6.29	0.25	63.5 x 115	9.00	0.20
4700	51 x 75	5.85	0.25	51 x 95	6.44	0.25	63.5 x 95	7.10	0.25	63.5 x 130	10.33	0.20
5600	51 x 95	7.03	0.25	51 x 115	7.55	0.25	63.5 x 95	7.77	0.25	76 x 115	11.36	0.20
6800	51 x 95	7.77	0.25	51 x 130	8.77	0.25	63.5 x 115	9.14	0.25	76 x 130	13.10	0.20
8200	51 x 115	9.14	0.25	63.5 x 95	9.40	0.25	63.5 x 115	10.03	0.25	76 x 155	15.43	0.20
10000	63.5 x 95	10.36	0.25	63.5 x 95	10.36	0.25	63.5 x 130	11.66	0.25	89 x 155	18.13	0.20
12000	63.5 x 95	11.32	0.25	76 x 95	12.06	0.25	76 x 115	12.88	0.25	89 x 155	20.02	0.20
15000	63.5 x 130	14.28	0.25	76 x 95	14.43	0.25	76 x 130	15.10	0.25	89 x 195	24.50	0.20
18000	63.5 x 130	15.61	0.25	76 x 130	16.50	0.25	76 x 155	17.69	0.25	89 x 235	28.83	0.20
22000	76 x 130	18.28	0.25	76 x 155	19.61	0.25	89 x 155	20.91	0.25			
27000	76 x 130	20.24	0.25	89 x 130	21.51	0.25						
30000	89 x 130	23.75	0.25	89 x 155	25.53	0.25						
39000	89 x 155	27.86	0.25									

Note: 1. Ripple Current: (A/rms) 85°C, 120Hz.

2. Dissipation Factor: 120Hz / 20°C

## CASE SIZE & PERMISSIBLE RIPPLE CURRENT OF STANDARD PRODUCTS

D x L: mm

CAP. (μF)	RATED VOLTAGE WV (SURGE VOLTAGE WV)					
	400 (450) SIZE	RIPPLE CURRENT	DISSIPATION FACTOR	450 (500) SIZE	RIPPLE CURRENT	DISSIPATION FACTOR
270				35 x 50	1.37	0.20
330	35 x 50	1.52	0.20	35 x 80	1.82	0.20
390	35 x 80	1.96	0.20	35 x 80	1.96	0.20
470	35 x 80	2.15	0.20	35 x 80	2.15	0.20
560	35 x 80	2.37	0.20	35 x 100	2.55	0.20
680	35 x 100	1.82	0.20	35 x 100	2.81	0.20
820	35 x 100	3.07	0.20	51 x 75	3.18	0.20
1000	51 x 75	3.48	0.20	51 x 75	3.48	0.20
1200	51 x 75	3.82	0.20	51 x 95	4.22	0.20
1500	51 x 95	4.70	0.20	51 x 115	5.07	0.20
1800	51 x 95	5.15	0.20	51 x 130	5.85	0.20
2200	51 x 130	6.44	0.20	63.5 x 95	6.29	0.20
2700	51 x 130	6.96	0.20	63.5 x 115	7.48	0.20
3300	63.5 x 95	8.22	0.20	63.5 x 130	8.66	0.20
3900	63.5 x 115	9.40	0.20	76 x 115	9.47	0.20
4700	63.5 x 130	10.44	0.20	76 x 130	10.88	0.20
5600	76 x 115	11.92	0.20	76 x 155	12.80	0.20
6800	76 x 155	14.06	0.20	89 x 155	15.00	0.20
8200	89 x 155	16.43	0.20	89 x 155	16.50	0.20
10000	89 x 155	18.28	0.20	89 x 195	20.00	0.20
12000	89 x 195	21.84	0.20	89 x 235	23.61	0.20
15000	89 x 235	26.31	0.20			

Note: 1. Ripple Current: (A/rms) 85°C, 120Hz.

2. Dissipation Factor: 120Hz / 20°C

# NM [Wide Temperature]

105°C 2000 Hours, Applicable for Large Power Source, Converter Circuit

## Screw Type Aluminum Electrolytic Capacitors

### ELECTRICAL CHARACTERISTICS

Operating Temperature Range	-40 to +105°C	-25 to +105°C
Rated Voltage Range	25 ~ 100V	160 ~ 450V
Rated Capacitance Range	220 ~ 330000μF	
Capacitance Tolerance	±20% (120Hz, +20°C)	
Leakage Current	I = 0.02CV or 5mA whichever is smaller. (After 5 Minutes Application of DC Rated Voltage at 20°C)	
Dissipation Factor at 120Hz, +20°C	Less than the Value Specified in the Standard Product Tables	
Endurance	After the rated voltage has been applied at 105°C for 2000 hours and then has resumed its original condition for 16 hours. (a) Capacitance Change: ±20% Initial Measured Value (b) Dissipation Factor: ≤ 2 Times Initial Specified Value (c) Leakage Current: ≤ Initial Specified Value	
Shelf Life	After having been stored for 1000 hours at 105°C, the rated voltage has been applied for 30 minutes and then has resumed its original condition for 16 hours. (a) Capacitance Change: ±20% Initial Measured Value (b) Dissipation Factor: ≤ 2 Times Initial Specified Value (c) Leakage Current: ≤ Initial Specified Value	

### DIAGRAM OF DIMENSIONS

Unit: mm

Dø	F
35	12.7
51	22
63.5	28.6
76	32
89	32

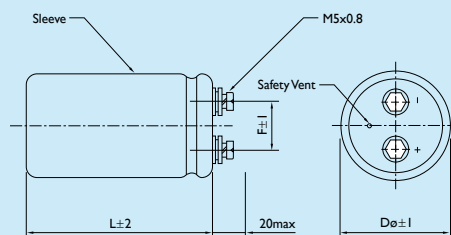

### DESCRIPTION

Endurance : 105°C 2000 Hours

High Ripple Current, Load Life of 2000 hours at 105°C

### MULTIPLIER FOR RIPPLE CURRENT

Frequency Coefficient

FREQUENCY (Hz)	50	60	100 (120)
FACTOR	0.80	0.80	1.00
FREQUENCY (Hz)	300	1K	≥10K
FACTOR	1.10	1.30	1.40

## CASE SIZE & PERMISSIBLE RIPPLE CURRENT OF STANDARD PRODUCTS

D x L: mm

CAP. (μF)	RATED VOLTAGE WV (SURGE VOLTAGE WV)								
	25 (32)			35 (44)			50 (63)		
	SIZE	RIPPLE CURRENT	DISSIPATION FACTOR	SIZE	RIPPLE CURRENT	DISSIPATION FACTOR	SIZE	RIPPLE CURRENT	DISSIPATION FACTOR
3300							35 x 50	2.20	0.2
4700							35 x 50	3.30	0.25
6800				35 x 50	2.60	0.30	35 x 80	3.40	0.25
10000	35 x 50	2.90	0.35	35 x 80	3.70	0.30	35 x 80	4.10	0.25
15000	35 x 80	4.20	0.35	35 x 80	4.50	0.30	35 x 100	4.90	0.30
22000	35 x 80	5.10	0.35	35 x 100	5.50	0.35	51 x 75	5.90	0.35
33000	35 x 100	6.30	0.40	51 x 75	6.70	0.40	51 x 115	7.80	0.40
47000	51 x 75	8.00	0.40	51 x 95	8.10	0.45	63.5 x 95	9.50	0.40
68000	51 x 115	10.00	0.50	51 x 115	10.00	0.50	63.5 x 115	11.60	0.45
100000	63.5 x 95	11.30	0.60	63.5 x 115	12.10	0.60	76 x 115	14.10	0.50
150000	63.5 x 115	12.90	0.80	76 x 115	13.80	0.70	89 x 130	18.90	0.50
220000	76 x 115	14.80	1.00	89 x 130	17.60	0.70			
330000	89 x 130	19.90	1.00						

Note: 1. Ripple Current: (A/rms) 105°C, 120Hz

2. Dissipation Factor: 120Hz / 20°C

## CASE SIZE & PERMISSIBLE RIPPLE CURRENT OF STANDARD PRODUCTS

D x L: mm

CAP. (μF)	RATED VOLTAGE WV (SURGE VOLTAGE WV)								
	63 (79)			80 (100)			100 (125)		
	SIZE	RIPPLE CURRENT	DISSIPATION FACTOR	SIZE	RIPPLE CURRENT	DISSIPATION FACTOR	SIZE	RIPPLE CURRENT	DISSIPATION FACTOR
1000							35 x 50	1.40	0.15
1500							35 x 50	1.70	0.15
2200	35 x 50	2.10	0.15	35 x 50	2.10	0.15	35 x 80	2.50	0.15
3300	35 x 50	2.20	0.20	35 x 80	3.00	0.15	35 x 80	3.00	0.15
4700	35 x 80	3.10	0.20	35 x 80	3.60	0.15	35 x 100	3.90	0.15
6800	35 x 80	3.70	0.20	35 x 100	4.00	0.20	51 x 75	5.00	0.15
10000	35 x 100	4.40	0.25	51 x 75	5.20	0.20	51 x 95	6.50	0.15
15000	51 x 75	5.70	0.25	51 x 95	6.20	0.25	63.5 x 95	7.60	0.20
22000	51 x 95	6.80	0.30	63.5 x 95	8.20	0.25	76 x 95	9.70	0.20
33000	63.5 x 95	9.20	0.30	76 x 95	9.70	0.30	76 x 130	11.80	0.25
47000	63.5 x 115	10.90	0.35	76 x 115	12.50	0.30	89 x 130	15.00	0.25
68000	76 x 115	13.00	0.40	89 x 130	16.40	0.30			
100000	89 x 130	17.20	0.40						

Note: 1. Ripple Current: (A/rms) 105°C, 120Hz

2. Dissipation Factor: 120Hz / 20°C

## CASE SIZE & PERMISSIBLE RIPPLE CURRENT OF STANDARD PRODUCTS

D x L: mm

CAP. (μF)	RATED VOLTAGE WV (SURGE VOLTAGE WV)								
	160 (200)			200 (250)			250 (300)		
	SIZE	RIPPLE CURRENT	DISSIPATION FACTOR	SIZE	RIPPLE CURRENT	DISSIPATION FACTOR	SIZE	RIPPLE CURRENT	DISSIPATION FACTOR
330				35 x 50	0.80	0.15	35 x 50	0.80	0.15
470	35 x 50	1.00	0.15	35 x 50	1.00	0.15	35 x 50	1.00	0.15
680	35 x 50	1.10	0.15	35 x 50	1.10	0.15	35 x 80	1.40	0.15
1000	35 x 80	1.70	0.15	35 x 80	1.70	0.15	35 x 100	1.90	0.15
1500	35 x 80	2.00	0.15	35 x 100	2.20	0.15	51 x 75	2.30	0.15
2200	35 x 100	2.70	0.15	51 x 75	2.80	0.15	51 x 95	3.10	0.15
3300	51 x 80	3.50	0.15	51 x 95	3.70	0.15	63.5 x 95	4.20	0.15
4700	51 x 95	4.40	0.15	63.5 x 95	4.90	0.15	63.5 x 115	5.40	0.15
6800	63.5 x 95	5.90	0.15	63.5 x 115	6.30	0.15	76 x 115	6.90	0.15
10000	76 x 95	7.60	0.15	76 x 115	8.10	0.15	76 x 155	9.30	0.15
15000	76 x 130	10.30	0.15	89 x 130	10.90	0.15	89 x 155	12.20	0.15
22000	89 x 130	13.20	0.15						

Note: 1. Ripple Current: (A/rms) 105°C, 120Hz

2. Dissipation Factor: 120Hz / 20°C

## CASE SIZE & PERMISSIBLE RIPPLE CURRENT OF STANDARD PRODUCTS

D x L: mm

CAP. (μF)	RATED VOLTAGE WV (SURGE VOLTAGE WV)					
	400 (450) SIZE			450 (500) SIZE		
		RIPPLE CURRENT	DISSIPATION FACTOR		RIPPLE CURRENT	DISSIPATION CURRENT
220				35 x 50	1.10	0.15
330				35 x 100	1.50	0.15
470				51 x 80	2.10	0.15
680				51 x 95	2.70	0.15
1000	51 x 75	2.50	0.15	51 x 100	4.20	0.15
1200	51 x 95	3.00	0.15			
1500	51 x 115	3.60	0.15	51 x 130	5.70	0.15
1800	51 x 130	4.10	0.15			
2200	63.5 x 95	4.50	0.15	63.5 x 115	7.30	0.15
2700	63.5 x 115	5.30	0.15			
3300	63.5 x 130	6.20	0.15	76 x 130	10.10	0.15
3900	63.5 x 155	7.20	0.15			
	76 x 115	6.80	0.15			
4700	63.5 x 195	8.70	0.15	76 x 155	12.60	0.15
	76 x 130	7.80	0.15			
5600	63.5 x 195	9.60	0.15	89 x 155	15.80	0.15
	76 x 155	9.20	0.15			
6800	89 x 155	10.70	0.15			
8200	89 x 155	11.80	0.15			
10000	89 x 195	14.10	0.15			

Note: 1. Ripple Current: (A/rms) 105°C, 120Hz

2. Dissipation Factor: 120Hz / 20°C



# NG [ Low Voltage, Large Capacity ]

85°C 2000 Hours, Low Leakage Current, Small Size and High Ripple Current

## Screw Type Aluminum Electrolytic Capacitors

### ELECTRICAL CHARACTERISTICS

Operating Temperature Range	-40 to +85°C
Rated Voltage Range	10 ~ 100V
Rated Capacitance Range	2200 ~ 1000000μF
Capacitance Tolerance	±20% (120Hz, 20°C)
Leakage Current	D = 35mm I ≤ 0.02CV (μA) or 4mA (at 20°C, after 2 minutes, whichever is smaller.) D ≥ 51mm I ≤ 0.03CV (μA) or 6mA (at 20°C, after 2 minutes, whichever is smaller.)
Endurance	After the rated voltage has been applied at 85°C for 2000 hours and then has resumed its original condition for 16 hours. (a) Capacitance Change: ±15% Initial Measured Value (b) Dissipation Factor: ≤ 2 Times Initial Specified Value (c) Leakage Current: ≤ Initial Specified Value
Shelf Life	After having been stored for 1000 hours at 85°C and then has resumed its original condition for 16 hours. (a) Capacitance Change: ±15% Initial Measured Value (b) Dissipation Factor: ≤ 2 Times Initial Specified Value (c) Leakage Current: ≤ Initial Specified Value



### DESCRIPTION

Endurance : 85°C 2000 Hours  
Low Voltage (≤ 100V), Large Capacitance, Lug or Screw Type, Low Dissipation Factor

### DIAGRAM OF DIMENSIONS

Unit: mm

Dø	F	L
35	12	50, 60, 80, 100, 120
51	22	80, 100, 120
63.5	28	100, 120, 140
76	32	100, 120, 140
89	32	140

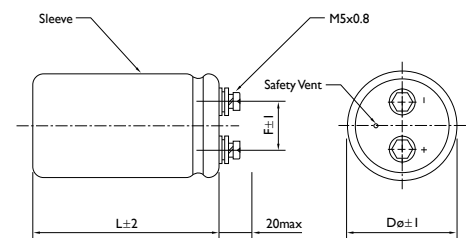
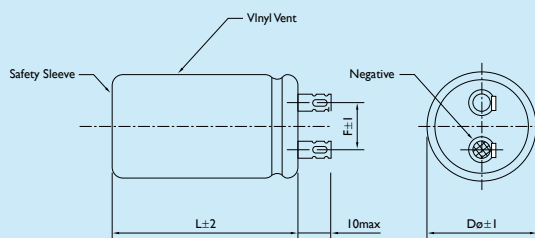

## CASE SIZE & PERMISSIBLE RIPPLE CURRENT OF STANDARD PRODUCTS

D x L: mm

CAP. (μF)	RATED VOLTAGE WV (SURGE VOLTAGE WV)								
	6.3 (8)			10 (13)			16 (20)		
	SIZE	RIPPLE CURRENT	DISSIPATION FACTOR	SIZE	RIPPLE CURRENT	DISSIPATION FACTOR	SIZE	RIPPLE CURRENT	DISSIPATION FACTOR
22000							35 × 50	4.50	0.50
33000				35 × 50	4.20	0.75	35 × 80	6.40	0.50
47000				35 × 80	6.20	0.75	35 × 100	8.20	0.50
68000				35 × 100	8.00	0.75	35 × 120	10.50	0.50
100000				35 × 120	10.40	0.75	51 × 80	10.70	0.75
150000				51 × 80	11.30	1.00	51 × 120	14.80	0.75
220000				51 × 120	15.50	1.00	63.5 × 120	17.00	1.00
330000				63.5 × 120	17.00	1.50	76 × 120	14.80	1.50
470000				76 × 120	21.90	2.00			
1000000	63.5 × 140	40.00	1.50	63.5 × 140	35.00	1.50	76 × 140	30.00	1.50

Note: 1. Ripple Current: (A/rms) 85°C, 120Hz

2. Dissipation Factor: 120Hz / 20°C

## CASE SIZE & PERMISSIBLE RIPPLE CURRENT OF STANDARD PRODUCTS

D x L: mm

CAP. (μF)	RATED VOLTAGE W V (SURGE VOLTAGE W V)								
	25 (32)			35 (44)			50 (63)		
	SIZE	RIPPLE CURRENT	DISSIPATION FACTOR	SIZE	RIPPLE CURRENT	DISSIPATION FACTOR	SIZE	RIPPLE CURRENT	DISSIPATION FACTOR
6800							35 x 50	3.60	0.25
10000				35 x 50	4.30	0.25	35 x 60	4.70	0.25
15000	35 x 50	4.40	0.35	35 x 80	6.20	0.25	35 x 80	6.20	0.25
22000	35 x 80	6.30	0.35	35 x 100	8.00	0.25	51 x 80	7.30	0.35
33000	35 x 100	8.30	0.35	51 x 80	9.00	0.35	51 x 80	9.00	0.35
47000	51 x 80	8.90	0.50	51 x 100	11.50	0.35	51 x 100	11.50	0.35
68000	51 x 80	10.80	0.50	51 x 120	14.60	0.35	63.5 x 100	12.70	0.50
100000	51 x 120	14.80	0.50	63.5 x 100	15.40	0.50	76 x 100	16.60	0.50
150000	63.5 x 120	16.20	0.75	76 x 120	21.40	0.50			
220000	76 x 120	21.20	0.75						
1000000	89 x 140	28.00	0.75						

Note: 1. Ripple Current: (A/rms) 85°C, 120Hz

2. Dissipation Factor: 120Hz / 20°C

## CASE SIZE & PERMISSIBLE RIPPLE CURRENT OF STANDARD PRODUCTS

D x L: mm

CAP. (μF)	RATED VOLTAGE W V (SURGE VOLTAGE W V)								
	63 (79)			80 (100)			100 (125)		
	SIZE	RIPPLE CURRENT	DISSIPATION FACTOR	SIZE	RIPPLE CURRENT	DISSIPATION FACTOR	SIZE	RIPPLE CURRENT	DISSIPATION FACTOR
2200							35 x 50	2.10	0.25
3300							35 x 80	3.00	0.25
4700	35 x 50	3.00	0.25	35 x 80	3.40	0.25	35 x 100	3.90	0.25
6800	35 x 60	3.90	0.25	35 x 80	4.30	0.25	35 x 120	4.90	0.25
10000	35 x 80	5.10	0.25	35 x 100	4.20	0.25	51 x 80	6.00	0.25
				51 x 80	6.00	0.30			
15000	51 x 80	6.70	0.35	51 x 100	7.00	0.30	51 x 120	8.30	0.25
22000	51 x 80	7.40	0.35	63.5 x 100	7.80	0.35	63.5 x 120	9.10	0.35
33000	51 x 100	9.70	0.35	76 x 100	10.50	0.40	76 x 120	12.00	0.35
47000	63.5 x 100	10.50	0.50	76 x 120	13.50	0.40			
100000	63.5 x 120	13.4	0.50						

Note: 1. Ripple Current: (A/rms) 85°C, 120Hz

2. Dissipation Factor: 120Hz / 20°C

# Screw Type Aluminum Electrolytic Capacitors

# NF [ Long Life for Inverter ]

85°C 5000 Hours, Specially For Higher Voltage with Compact Size



## DESCRIPTION

Endurance : 85°C, 5000 Hours

Higher voltage with compact size, to be used in inverters.

### MULTIPLIER FOR RIPPLE CURRENT

Frequency Coefficient

FREQUENCY (Hz)	50	60	100(120)	300	1K	≥10K
FACTOR	0.70	0.70	1.00	1.10	1.30	1.40

## ELECTRICAL CHARACTERISTICS

Operating Temperature Range	-40 to +85°C		
Rated Voltage Range	400V, 450V		
Rated Capacitance Range	1800 ~ 22000μF		
Capacitance Tolerance	±20% (120Hz, +20°C)		
Leakage Current	I = 0.01CV or 5mA Whichever is smaller. (After 5 Minutes Application of DC Voltage at 20°C)		
Dissipation Factor at 120Hz, +20°C	Rate Voltage (V)	400	450
	tan δ	0.15	0.15
Endurance	After the rated voltage has been applied at 85°C for 5000 hours, and then has resumed its original condition for 16 hours. (a) Capacitance Change: ±15% Initial Measured Value (b) Dissipation Factor: ≤ 1.75 Times Initial Specified Value (c) Leakage Current: ≤ Initial Specified Value		
Shelf Life	After having been stored for 1000 hours at 85°C, the rated voltage has been applied for 30 minutes, and then has resumed its original condition for 16 hours. (a) Capacitance Change: ±15% Initial Measured Value (b) Dissipation Factor: ≤ 1.75 Times Initial Specified Value (c) Leakage Current: ≤ Initial Specified Value		

## DIAGRAM OF DIMENSIONS

Unit: mm

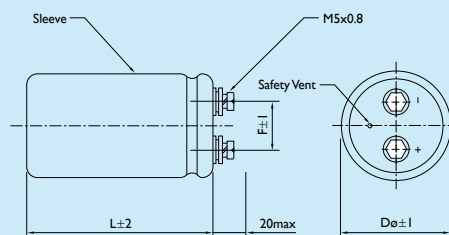

Dø	F
51	22
63.5	28.6
76	32
89	32
101	41.5

## CASE SIZE & PERMISSIBLE RIPPLE CURRENT OF STANDARD PRODUCTS

D x L: mm

CAP. (μF)	RATED VOLTAGE WV (SURGE VOLTAGE WV)					
	400 (450) SIZE			450 (500) SIZE		
		RIPPLE CURRENT	DISSIPATION FACTOR		RIPPLE CURRENT	DISSIPATION FACTOR
1800				51 x 115	7.60	0.15
2200	51 x 115	8.80	0.15	51 x 130	8.80	0.15
2700	51 x 130	10.20	0.15	63.5 x 95	9.50	0.15
3300	63.5 x 95	11.00	0.15	63.5 x 115	11.20	0.15
3900	63.5 x 115	12.80	0.15	63.5 x 130	12.80	0.15
4700	63.5 x 130	14.80	0.15	76 x 115	14.10	0.15
5600	76 x 115	16.20	0.15	76 x 130	16.20	0.15
6800	76 x 130	18.70	0.15	76 x 155	19.10	0.15
8200	76 x 155	22.00	0.15	76 x 195	23.00	0.15
				89 x 130	21.00	0.15
10000	76 x 195	26.70	0.15	89 x 170	25.70	0.15
	89 x 130	24.20	0.15			
12000	89 x 155	28.50	0.15	89 x 195	29.70	0.15
				101 x 175	29.30	0.15
15000	89 x 195	34.80	0.15	89 x 235	35.90	0.15
				101 x 195	34.20	0.15
18000	89 x 235	41.20	0.15	101 x 235	40.20	0.15
22000	101 x 235	47.00	0.15			

Note: 1. Ripple Current: (A/rms) 85°C, 120Hz

2. Dissipation Factor: 120Hz / 20°C

# Screw Type Aluminum Electrolytic Capacitors

# NH [ High Temperature, Long Life for Inverter ]

105°C 5000 Hours, High Ripple Current Products



## DESCRIPTION

Endurance : 105°C 5000 Hours

### MULTIPLIER FOR RIPPLE CURRENT

Frequency Coefficient

FREQUENCY (Hz)	50	120	1K	10K	50K
10~50V	0.95	1.00	1.05	1.09	1.12
63~100V	0.90	1.00	1.10	1.18	1.22
100~250V	0.80	1.00	1.22	1.30	1.33
350~500V	0.80	1.00	1.50	1.60	1.70

## ELECTRICAL CHARACTERISTICS

Operating Temperature Range	-40 to +105°C	-25 to +105°C
Rated Voltage Range	10 ~ 100V	160 ~ 500V
Rated Capacitance Range	330 ~ 390000µF	
Capacitance Tolerance	±20% (120Hz, +20°C)	
Leakage Current	I = 0.02CV or 5mA whichever is smaller. (After 5 Minutes Application of DC Voltage at 20°C)	
Temperature Characteristics	Impedance Ratio at 120Hz	
	Ur (V)	10~100      160~500
	Z -25°C / Z +20°C	-                  8
	Z -40°C / Z +20°C	12                -
Endurance	After the rated voltage has been applied at 105°C for 5000 hours and then has resumed its original condition for 16 hours. (a) Capacitance Change: ±20% Initial Measured Value (b) Dissipation Factor: ≤ 2 Times Initial Specified Value (c) Leakage Current: ≤ Initial Specified Value	
Shelf Life	After having been stored for 1000 hours at 105°C, the rated voltage has been applied for 30 minutes and then has resumed its original condition for 16 hours. (a) Capacitance Change: ±20% Initial Measured Value (b) Dissipation Factor: ≤ 2 Times Initial Specified Value (c) Leakage Current: ≤ Initial Specified Value	

## DIAGRAM OF DIMENSIONS

Unit: mm

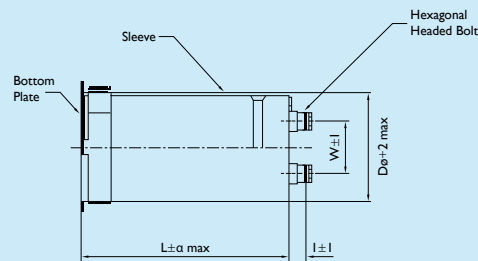

Dø	W	l	α	NOMINAL DIA. OF BOLT
51	22	6	3	M5
63.5	28.6	6	3	M5
76	31.8	6	3	M5
89	31.8	6	3	M5

## CASE SIZE & PERMISSIBLE RIPPLE CURRENT OF STANDARD PRODUCTS

D x L: mm

CAP. ( $\mu$ F)	RATED VOLTAGE WV (SURGE VOLTAGE WV)											
	10 (13)			16 (20)			25 (32)			35 (44)		
	SIZE	RIPPLE CURRENT	DISSIPATION FACTOR	SIZE	RIPPLE CURRENT	DISSIPATION FACTOR	SIZE	RIPPLE CURRENT	DISSIPATION FACTOR	SIZE	RIPPLE CURRENT	DISSIPATION FACTOR
8200										35 x 80	3.0	0.30
10000										35 x 80	3.3	0.30
12000							35 x 80	3.3	0.35	35 x 80	3.6	0.30
15000				35 x 50	2.9	0.45	35 x 80	3.7	0.35	35 x 80	4.1	0.30
18000				35 x 80	3.5	0.45	35 x 80	4.0	0.35	35 x 100	4.8	0.30
22000				35 x 80	3.9	0.45	35 x 80	4.5	0.35	35 x 120	5.2	0.35
27000	35 x 80	4.3	0.45	35 x 80	4.3	0.45	35 x 100	5.0	0.40	51 x 80	5.9	0.40
33000	35 x 80	4.7	0.45	35 x 100	4.8	0.50	35 x 120	5.9	0.40	51 x 100	6.6	0.40
39000	35 x 80	5.3	0.45	35 x 100	5.3	0.50	51 x 80	6.5	0.40	51 x 120	7.8	0.40
47000	35 x 100	6.1	0.45	35 x 120	6.2	0.50	51 x 100	7.9	0.40	51 x 120	8.0	0.45
56000	35 x 100	6.2	0.50	51 x 80	6.3	0.60	51 x 120	8.8	0.40	63.5 x 100	9.2	0.45
68000	35 x 120	6.8	0.60	51 x 100	7.6	0.60	51 x 120	9.1	0.50	63.5 x 120	11.0	0.45
82000	51 x 80	7.8	0.60	51 x 120	8.3	0.70	63.5 x 100	10.6	0.50	76 x 120	12.7	0.50
100000	51 x 100	8.5	0.70	51 x 120	9.2	0.70	63.5 x 120	11.4	0.60	76 x 140	13.5	0.60
120000	51 x 100	9.5	0.70	63.5 x 100	9.9	0.80	76 x 100	12.8	0.60	89 x 140	16.1	0.60
150000	63.5 x 100	11.0	0.80	76 x 100	12.3	0.80	76 x 120	13.7	0.75			
180000	63.5 x 100	12.1	0.80	76 x 120	14.5	0.80	76 x 140	16.1	0.76			
220000	76 x 100	13.2	1.00	76 x 140	15.2	1.00	89 x 140	16.6	1.00			
270000	76 x 120	14.4	1.20	89 x 140	16.8	1.20						
330000	76 x 140	17.0	1.20									
390000	89 x 140	18.6	1.40									

Note: 1. Max. Allowable Ripple Current: (A/rms) 105°C, 120Hz

2. Dissipation Factor: 120Hz / 20°C

## CASE SIZE & PERMISSIBLE RIPPLE CURRENT OF STANDARD PRODUCTS

D x L: mm

CAP. ( $\mu$ F)	RATED VOLTAGE WV (SURGE VOLTAGE WV)											
	50 (63)			63 (79)			80 (100)			100 (125)		
	SIZE	RIPPLE CURRENT	DISSIPATION FACTOR	SIZE	RIPPLE CURRENT	DISSIPATION FACTOR	SIZE	RIPPLE CURRENT	DISSIPATION FACTOR	SIZE	RIPPLE CURRENT	DISSIPATION FACTOR
1200										35 x 50	1.4	0.15
1500										35 x 80	1.6	0.15
1800										35 x 80	1.8	0.15
2200							35 x 50	1.9	0.15	35 x 80	2.0	0.15
2700				35 x 50	1.9	0.19	35 x 80	2.2	0.15	35 x 80	2.4	0.15
3300				35 x 50	2.1	0.15	35 x 80	2.5	0.15	35 x 100	2.8	0.15
3900	35 x 50	2.0	0.20	35 x 80	2.7	0.20	35 x 80	2.9	0.15	35 x 120	3.1	0.15
4700	35 x 50	2.2	0.25	35 x 80	2.9	0.20	35 x 100	3.1	0.15	51 x 80	3.6	0.15
5600	35 x 80	2.8	0.25	35 x 80	3.2	0.20	35 x 100	3.6	0.15	51 x 100	4.3	0.15
6800	35 x 80	3.0	0.25	35 x 80	3.5	0.20	35 x 120	4.1	0.20	51 x 120	5.0	0.15
8200	35 x 80	3.3	0.25	35 x 100	4.2	0.25	51 x 80	4.8	0.20	51 x 120	5.5	0.15
10000	35 x 80	3.7	0.25	35 x 120	4.3	0.25	51 x 100	5.6	0.20	63.5 x 100	6.4	0.15
12000	35 x 100	4.4	0.25	51 x 80	4.8	0.25	51 x 100	6.1	0.20	63.5 x 120	6.6	0.20
15000	35 x 120	4.7	0.30	51 x 100	5.9	0.25	51 x 120	7.4	0.20	76 x 100	7.5	0.20
18000	51 x 80	4.8	0.35	51 x 120	6.3	0.30	63.5 x 120	8.0	0.25	76 x 120	8.0	0.25
22000	51 x 100	5.9	0.35	51 x 120	6.7	0.30	76 x 100	9.1	0.25	76 x 140	9.4	0.25
27000	51 x 120	7.0	0.35	63.5 x 120	8.8	0.30	76 x 120	9.7	0.30	89 x 140	10.4	0.30
33000	63.5 x 100	7.6	0.40	76 x 120	10.0	0.35	76 x 140	11.5	0.30			
39000	63.5 x 120	8.9	0.40	76 x 140	12.5	0.35	89 x 140	12.5	0.30			
47000	63.5 x 120	9.8	0.40	89 x 140	13.8	0.40						
56000	76 x 120	11.9	0.40									
68000	76 x 140	13.1	0.45									
82000	89 x 140	14.8	0.50									

Note: 1. Max. Allowable Ripple Current: (A/rms) 105°C, 120Hz

2. Dissipation Factor: 120Hz / 20°C



## CASE SIZE & PERMISSIBLE RIPPLE CURRENT OF STANDARD PRODUCTS

D x L: mm

CAP. (μF)	RATED VOLTAGE WV (SURGE VOLTAGE WV)											
	160 (200)			200 (250)			250 (300)			350 (400)		
	SIZE	RIPPLE CURRENT	DISSIPATION FACTOR	SIZE	RIPPLE CURRENT	DISSIPATION FACTOR	SIZE	RIPPLE CURRENT	DISSIPATION FACTOR	SIZE	RIPPLE CURRENT	DISSIPATION FACTOR
330							35 x 50	0.7	0.15			
390							35 x 80	0.8	0.15			
470				35 x 50	0.9	0.15	35 x 80	0.9	0.15			
560				35 x 80	1.0	0.15	35 x 80	1.0	0.15			
680	35 x 50	1.1	0.15	35 x 80	1.1	0.15	35 x 100	1.2	0.15			
820	35 x 80	1.2	0.15	35 x 80	1.3	0.15	35 x 100	1.4	0.15	51 x 81	3.3	0.25
1000	35 x 80	1.3	0.15	35 x 80	1.5	0.15	35 x 120	1.6	0.15			
1200	35 x 80	1.5	0.15	35 x 100	1.7	0.15	51 x 80	1.8	0.15			
1500	35 x 80	1.7	0.15	35 x 120	1.9	0.15	51 x 100	2.2	0.15	51 x 90	5.2	0.25
1800	35 x 100	2.0	0.15	35 x 120	2.2	0.15	51 x 120	2.6	0.15			
2200	35 x 120	2.3	0.15	51 x 80	2.7	0.15	51 x 120	2.8	0.15	51 x 100	7.0	0.25
2700	35 x 120	2.7	0.15	51 x 100	3.2	0.15	63.5 x 100	3.3	0.15	51 x 130	8.4	0.25
										63.5 x 90	8.1	0.25
3300	51 x 100	3.3	0.15	51 x 120	3.5	0.15	63.5 x 120	4.0	0.15	51 x 150	9.9	0.25
3900	51 x 120	3.8	0.15	63.5 x 100	4.0	0.15	76 x 100	4.4	0.15	63.5 x 130	11.5	0.25
										76 x 90	10.8	0.25
4700	51 x 120	4.2	0.15	63.5 x 120	4.7	0.15	76 x 120	5.2	0.15			
5600	51 x 120	4.7	0.15	76 x 100	5.3	0.15	76 x 140	6.1	0.15	63.5 x 150	14.7	0.25
6800	63.5 x 120	5.7	0.15	76 x 120	6.3	0.15	89 x 140	7.4	0.15	76 x 130	16.8	0.25
8200	76 x 100	6.4	0.20	76 x 140	6.4	0.20				76 x 150	19.6	0.25
10000	76 x 120	6.8	0.20	89 x 140	7.7	0.20				76 x 190	23.0	0.25
12000	76 x 140	7.8	0.20									
15000	89 x 140	9.5	0.20							89 x 190	30.6	0.25
22000										89 x 270	43.5	0.25

Note: 1. Max. Allowable Ripple Current: (A/rms) 105°C, 120Hz

2. Dissipation Factor: 120Hz / 20°C

## CASE SIZE & PERMISSIBLE RIPPLE CURRENT OF STANDARD PRODUCTS

D × L: mm

CAP. (μF)	RATED VOLTAGE WV (SURGE VOLTAGE WV)								
	400 (450) SIZE			450 (500) SIZE			500 (550) SIZE		
	SIZE	RIPPLE CURRENT	DISSIPATION FACTOR	SIZE	RIPPLE CURRENT	DISSIPATION FACTOR	SIZE	RIPPLE CURRENT	DISSIPATION FACTOR
470							51 × 80	2.4	0.20
560				51 × 80	2.6	0.25			
680	51 × 80	3.0	0.25						
820							51 × 90	3.6	0.20
1000				51 × 90	4.0	0.25	51 × 110	4.4	0.20
1200	51 × 90	4.7	0.25	51 × 110	4.8	0.25	51 × 130	5.2	0.20
							63.5 × 90	5.0	0.20
1500							51 × 150	6.3	0.20
1800	51 × 110	6.3	0.25	51 × 130	6.4	0.25	63.5 × 110	6.8	0.20
				63.5 × 90	6.2	0.25			
2200	51 × 130	7.5	0.25	51 × 150	7.6	0.25			
	63.5 × 90	7.3	0.25	63.5 × 100	7.5	0.25			
2700	51 × 150	8.9	0.25	63.5 × 130	8.9	0.25	63.5 × 150	9.6	0.20
	63.5 × 110	8.8	0.25	76 × 90	8.4	0.25	76 × 110	9.2	0.20
3300	63.5 × 130	10.5	0.25	63.5 × 150	10.6	0.25			
	76 × 90	9.9	0.25	76 × 110	10.2	0.25			
3900				76 × 130	11.9	0.25	76 × 150	12.7	0.20
							89 × 130	11.9	0.20
4700	63.5 × 150	13.4	0.25	76 × 150	14.0	0.25			
	76 × 130	13.9	0.25						
5600				89 × 130	14.2	0.25			
6800	76 × 150	17.9	0.25	76 × 190	17.3	0.25	89 × 190	18.8	0.20
	89 × 130	17.2	0.25	89 × 150	16.7	0.25			
8200	76 × 190	20.8	0.25						
	89 × 150	20.1	0.25						
10000				89 × 190	22.8	0.25	89 × 270	26.8	0.20
12000	89 × 190	27.4	0.25						
15000				89 × 270	32.8	0.25			
22000	89 × 270	39.4	0.25						

Note: 1. Max. Allowable Ripple Current: (A/rms) 105°C, 120Hz

2. Dissipation Factor: 120Hz / 20°C

# S5 [ Super Miniature ]

105°C Single-Ended Lead, 5.0mm Height Type Aluminum Electrolytic Capacitors

## Miniature Aluminum Electrolytic Capacitors

### ELECTRICAL CHARACTERISTICS

Operating Temperature Range : -40 ~ +105°C

Rated Voltage Range : 4 ~ 50V

Rated Capacitance Range : 0.1 ~ 470μF

Capacitance Tolerance : -20 ~ +20% at 120Hz, 20°C

DC Leakage Current (μA) : I = 0.01CV (μA) or 3μA whichever is greater.  
(After Rated Voltage Applied for 2 Minutes )

Dissipation Factor : at 120 Hz, 20°C

WV (V) :	4	6.3	10	16	25	35	50
D.F (%) :	35	24	20	17	15	12	10

Endurance : After the rated voltage has been applied at 105°C for 1000 hours, the capacitors shall meet following requirements.

- (a) Capacitance Change : Within 20% of Initial Value
- (b) Dissipation Factor : 200% or Less of Initial Specified Value
- (c) Leakage Current : Initial Specified Value or Less

Shelf Life : After leaving capacitors under load at 105°C for 500 hours.

- (a) Capacitance Change : Within 20% of Initial Value
- (b) Dissipation Factor : 200% or Less of Initial Specified Value
- (c) Leakage Current : 200% or Less of Initial Specified Value

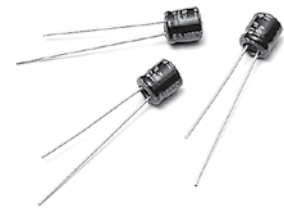

### DESCRIPTION

The S5 series is smaller than SS series.

This type is designed for saving space and high density insertion.

Applications : Camera, Car Audio, Miniaudio and Other Industrial and Commercial Applications

### MULTIPLIER FOR RIPPLE CURRENT

Frequency Coefficient

FREQUENCY (Hz)	120	300	1K	10K~100K
0.1~47μF	1.00	1.20	1.30	1.50
100~330μF	1.00	1.10	1.15	1.20

Temperature Coefficient

TEMPERATURE (°C)	65	85	105
FACTOR	1.40	1.20	1.00

### DIAGRAM OF DIMENSIONS

Dimensions: mm

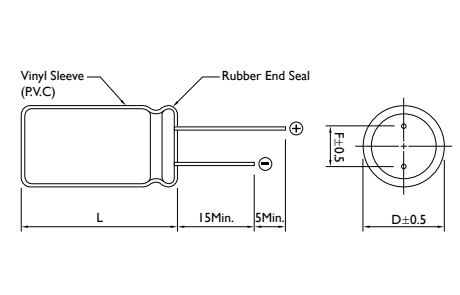
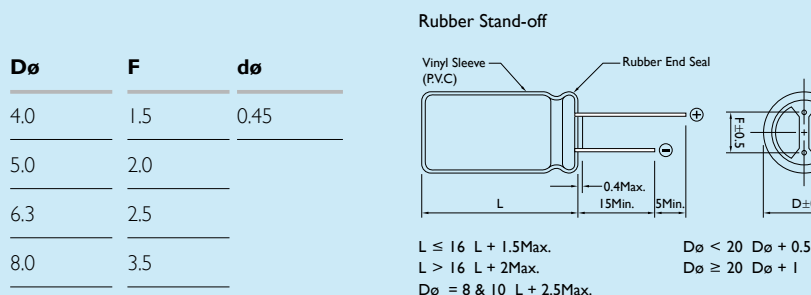

## CASE SIZE & PERMISSIBLE RIPPLE CURRENT OF STANDARD PRODUCTS

D x L: mm

CAP. (μF)	RATED VOLTAGE WV (SURGE VOLTAGE WV)													
	4 (5)		6.3 (8)		10 (13)		16 (20)		25 (32)		35 (44)		50 (63)	
	SIZE	RIPPLE	SIZE	RIPPLE	SIZE	RIPPLE	SIZE	RIPPLE	SIZE	RIPPLE	SIZE	RIPPLE	SIZE	RIPPLE
0.10													4 x 5	1
0.22													4 x 5	2
0.33													4 x 5	3
0.47													4 x 5	4
1.0													4 x 5	9
2.2													4 x 5	13
3.3													4 x 5	17
4.7							4 x 5	20	4 x 5	16	4 x 5	18	4 x 5	17
													5 x 5	20
10			4 x 5	18	4 x 5	20	4 x 5	23	4 x 5	20	5 x 5	30	6.3 x 5	33
15									5 x 5	27				
22	4 x 5	20	4 x 5	28	5 x 5	33	4 x 5	29	6.3 x 5	42	6.3 x 5	48	6.3 x 5	55
							5 x 5	37						
33	4 x 5	25	4 x 5	33	4 x 5	34	5 x 5	44	5 x 5	45				
					5 x 5	41	6.3 x 5	49	6.3 x 5	53				
47	5 x 5	30	4 x 5	35	5 x 5	46	5 x 5	54	5 x 5	55				
			5 x 5	45			6.3 x 5	58	6.3 x 5	65				
68					6.3 x 5	54								
100	6.3 x 5	50	5 x 5	55	6.3 x 5	80	6.3 x 5	85	8 x 5	90				
			6.3 x 5	70										
220	6.3 x 5	70	6.3 x 5	90										
330	8 x 5	110	8 x 5	115										
470			8 x 5	100										

Note: I. Ripple Current: (mA/rms) 105°C, 120Hz

# S7 [ Super Miniature ]

105°C 2,000 Hours, 4~63V

## Miniature Aluminum Electrolytic Capacitors

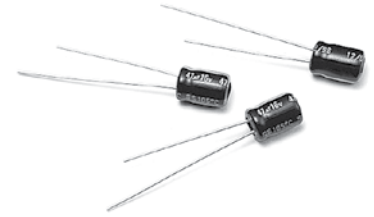

### ELECTRICAL CHARACTERISTICS

Operating Temperature Range : -55 ~ +105°C

Rated Voltage Range : 4 ~ 63V

Rated Capacitance Range : 0.1 ~ 470µF

Capacitance Tolerance : -20 ~ +20% at 120Hz, 20°C

DC Leakage Current (µA) : I = 0.01CV (µA) or 3µA whichever is greater.  
( After Rated Voltage Applied for 2 Minutes )

Dissipation Factor

WV (V) :	4	6.3	10	16	25	35	50	63
D.F. (%) :	35	23	20	17	15	12	10	10

Endurance : After the rated voltage has been applied at 105°C for 2000 hours

- (a) Capacitance Change : Within 20% of Initial Value
- (b) Dissipation Factor : 200% or Less of Initial Specified Value
- (c) Leakage Current : Initial Specified Value or Less

Shelf Life : After leaving capacitors under load at 105°C for 500 hours.

- (a) Capacitance Change : Within 20% of Initial Value
- (b) Dissipation Factor : 200% or Less of Initial Specified Value
- (c) Leakage Current : 200% or Less of Initial Specified Value

### DIAGRAM OF DIMENSIONS

Dø	F	dø
4.0	1.5	0.45
5.0	2.0	
6.3	2.5	
8.0	3.5	0.5

#### Rubber Stand-off

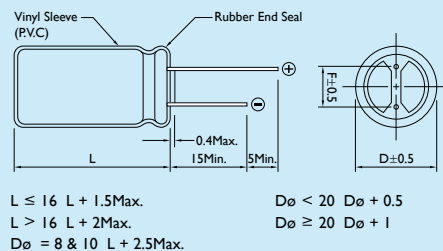

### DESCRIPTION

This type is designed to meet the demands of equipments with greatly reduced size and thickness, such as: portable micro computers, disk drivers, small calculators and audio equipment.

Applications : Portable Micro Computer; Disk Driver; Small Calculator and Audio

#### MULTIPLIER FOR RIPPLE CURRENT

Frequency Coefficient

FREQUENCY (Hz)	50	120	300	1K	10K
0.1~47µF	0.75	1.00	1.20	1.30	1.50
100~330µF	0.75	1.00	1.10	1.15	1.20

Temperature Coefficient

TEMPERATURE (°C)	65	85	105
FACTOR	1.70	1.30	1.00

### FEATURES

- 105°C 2,000 hours assured
- High temperature category with 7-9 mm height
- RoHS compliance

Dimensions: mm

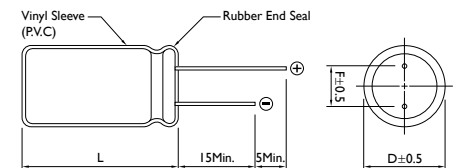

## CASE SIZE & PERMISSIBLE RIPPLE CURRENT OF STANDARD PRODUCTS

D x L: mm

CAP. (μF)	RATED VOLTAGE WV (SURGE VOLTAGE WV)															
	4 (5)		6.3 (8)		10 (13)		16 (20)		25 (32)		35 (44)		50 (63)		63 (79)	
	SIZE	RIPPLE	SIZE	RIPPLE	SIZE	RIPPLE	SIZE	RIPPLE	SIZE	RIPPLE	SIZE	RIPPLE	SIZE	RIPPLE	SIZE	RIPPLE
1.0													4 x 7	10	4 x 7	11
2.2													4 x 7	15	4 x 7	17
3.3													4 x 7	18	4 x 7	21
4.7											4 x 7	22	5 x 7	23	5 x 7	26
10					4 x 7	22	4 x 7	25	4 x 7	26	5 x 7	30	4 x 7	37	6 x 7	40
22			4 x 7	37	4 x 7	32	4 x 7	39	4 x 7	43	6.3 x 7	47	6.3 x 7	53	8 x 7	70
33	4 x 7	32	4 x 7	32	4 x 7	35	5 x 7	43	6.3 x 7	50	8 x 7	71	8 x 7	76		
47	4 x 7	38	4 x 7	38	5 x 7	47	6.3 x 7	59	6.3 x 7	65	8 x 7	83				
100	5 x 7	61	6.3 x 7	75	6.3 x 7	80	6.3 x 7	90	8 x 7	125	8 x 7	145				
150							6.3 x 7	120								
220	6.3 x 7	90	6.3 x 7	99	8 x 7	140	8 x 7	146								
							8 x 9	146								
330	8 x 7	150	8 x 7	156	8 x 7	165	8 x 9	185								
470	8 x 7	180	8 x 7	180												
			8 x 9	200	8 x 9	220	8 x 9	225								

Note: I<sub>r</sub> Ripple Current: (mA/rms) 105°C, 120Hz

# SS [ Super Miniature ]

105°C Single-Ended Lead Aluminum Electrolytic Capacitors

## Miniature Aluminum Electrolytic Capacitors

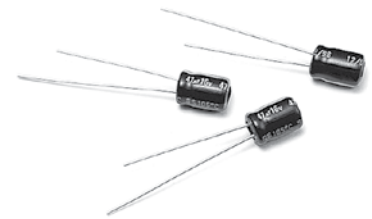

### DESCRIPTION

This type is designed to meet the demands of equipments with greatly reduced size and thickness, such as: portable micro computers, disk drivers, small calculators and audio equipment.

Applications : Portable Micro Computer; Disk Driver; Small Calculator and Audio

### MULTIPLIER FOR RIPPLE CURRENT

Frequency Coefficient

FREQUENCY (Hz)	50	120	300	1K	10K
0.1~47μF	0.75	1.00	1.20	1.30	1.50
100~330μF	0.75	1.00	1.10	1.15	1.20

Temperature Coefficient

TEMPERATURE (°C)	65	85	105
FACTOR	1.70	1.30	1.00

### ELECTRICAL CHARACTERISTICS

Operating Temperature Range : -40 ~ +105°C

Rated Voltage Range : 4 ~ 63V

Rated Capacitance Range : 0.1 ~ 470μF

Capacitance Tolerance : -20 ~ +20% at 120Hz, 20°C

DC Leakage Current (μA) : I = 0.01CV (μA) or 3μA whichever is greater.  
( After Rated Voltage Applied for 2 Minutes )

Dissipation Factor

WV (V) :	4	6.3	10	16	25	35	50	63
D.F. (%) :	35	24	20	17	15	12	10	8

Endurance : After the rated voltage has been applied at 105°C for 1000 hours

- (a) Capacitance Change : Within 20% of Initial Value
- (b) Dissipation Factor : 200% or Less of Initial Specified Value
- (c) Leakage Current : Initial Specified Value or Less

Shelf Life : After leaving capacitors under load at 105°C for 500 hours.

- (a) Capacitance Change : Within 20% of Initial Value
- (b) Dissipation Factor : 200% or Less of Initial Specified Value
- (c) Leakage Current : 200% or Less of Initial Specified Value

### DIAGRAM OF DIMENSIONS

Dimensions: mm

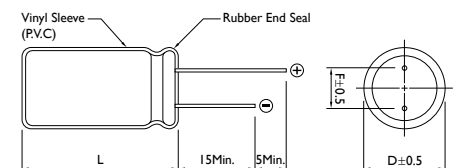
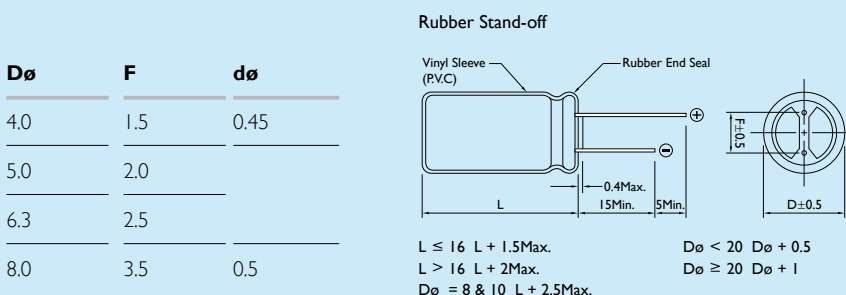

## CASE SIZE & PERMISSIBLE RIPPLE CURRENT OF STANDARD PRODUCTS

D x L: mm

CAP. (μF)	RATED VOLTAGE WV (SURGE VOLTAGE WV)															
	4 (5)		6.3 (8)		10 (13)		16 (20)		25 (32)		35 (44)		50 (63)		63 (79)	
	SIZE	RIPPLE	SIZE	RIPPLE	SIZE	RIPPLE	SIZE	RIPPLE	SIZE	RIPPLE	SIZE	RIPPLE	SIZE	RIPPLE	SIZE	RIPPLE
0.10													4 x 7	1	4 x 7	1
0.22													4 x 7	2	4 x 7	2
0.33													4 x 7	3	4 x 7	4
0.47													4 x 7	5	4 x 7	6
0.68													4 x 7	6		
1.0									4 x 7	10			4 x 7	10	4 x 7	13
2.2							4 x 7	7					4 x 7	19	4 x 7	21
3.3							4 x 7	13					4 x 7	24	4 x 7	26
4.7							4 x 7	19	4 x 7	24	4 x 7	24	4 x 7	29	4 x 7	26
											5 x 7	24	5 x 7	31	6.3 x 7	33
10					4 x 7	22	4 x 7	29	4 x 7	33	4 x 7	34	4 x 7	37	5 x 7	42
									5 x 7	35	5 x 7	36	5 x 7	45	6.3 x 7	50
									6.3 x 7	35			6.3 x 7	45		
22			4 x 7	37	4 x 7	31	4 x 7	36	4 x 7	43	5 x 7	48	6.3 x 7	65		
					5 x 7	38	5 x 7	44	5 x 7	51	6.3 x 7	57				
									6.3 x 7	53						
33	4 x 7	30	5 x 7	42	4 x 7	39	4 x 7	50	5 x 7	55	6.3 x 7	70	6.3 x 7	80		
					5 x 7	47	5 x 7	57	6.3 x 7	65						
47	4 x 7	35	4 x 7	46	4 x 7	50	5 x 7	75	5 x 7	67	6.3 x 7	81				
			5 x 7	55	5 x 7	60	6.3 x 7	77	6.3 x 7	79						
					6.3 x 7	60										
68							5 x 7	84								
100	5 x 7	55	5 x 7	75	5 x 7	85	5 x 7	94	6.3 x 7	120						
			6.3 x 7	90	6.3 x 7	100	6.3 x 7	110	8 x 7	120						
150							6.3 x 7	120								
220	6.3 x 7	95	6.3 x 7	130	6.3 x 7	135	6.3 x 7	110								
							8 x 7	140								
							8 x 9	140								
330			8 x 7	140			8 x 9	155								
470			8 x 7	130												
			8 x 9	150	8 x 9	165	8 x 9	170								

Note: I. Ripple Current: (mA/rms) 105°C, 120Hz



# SK [ For General ]

85°C Single-Ended Lead Aluminum Electrolytic Capacitors

## Miniature Aluminum Electrolytic Capacitors

### ELECTRICAL CHARACTERISTICS

Operating Temperature Range : -40 ~ +85°C / -25 ~ +85°C

Rated Voltage Range : 6.3 ~ 100V / 160 ~ 450V

Rated Capacitance Range : 0.1 ~ 22000µF / 0.47 ~ 470µF

Capacitance Tolerance : -20 ~ +20% at 120Hz, 20°C

DC Leakage Current (µA) : I = 0.01CV (µA) or 3µA / I = 0.03CV (µA) + 10µA whichever is greater.  
(After Rated Voltage Applied for 2 Minutes )

Dissipation Factor

WV (V):	6.3	10	16	25	35	50	63	100	160 ~ 250	350 ~ 450
D.F (%) :	24	20	16	14	12	10	10	10	20	24

For capacitors whose capacitance exceeds 1000µF. The value of DF(%) is increased by 2% for every addition of 1000µF.

Endurance : After the rated voltage has been applied at 85°C for 2000 hours, the capacitors shall meet following requirements.

- (a) Capacitance Change : Within 20% of Initial Value
- (b) Dissipation Factor : 200% or Less of Initial Specified Value
- (c) Leakage Current : Initial Specified Value or Less

Shelf Life : After have been placed at 85°C without voltage applied for 1000 hours the capacitors shall meet following requirements.

- (a) Capacitance Change : Within 20% of Initial Value
- (b) Dissipation Factor : 200% or Less of Initial Specified Value
- (c) Leakage Current : Initial Specified Value or Less

### DIAGRAM OF DIMENSIONS

Dø	F	dø
4.0	1.5	0.45
5.0	2.0	0.5
6.3	2.5	
8.0	3.5	0.6
10.0	5.0	
12.0		
13.0		
16.0	7.5	0.8
18.0		
22.0	10.0	

Rubber Stand-off

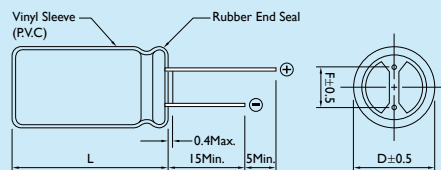

L ≤ 16 L + 1.5Max.  
L > 16 L + 2Max.  
Dø = 8 & 10 L + 2.5Max.  
Dø < 20 Dø + 0.5  
Dø ≥ 20 Dø + 1



### DESCRIPTION

Lower-cost capacitors suitable for high density printed circuit boards.

Very high volumetric efficiency

Ideally suited for general purpose applications, decoupling bypass, and filtering circuit in entertainment electronics.

Featuring high CV products with moderate cost

### MULTIPLIER FOR RIPPLE CURRENT

Frequency Coefficient

FREQUENCY (Hz)	120	300	1K	10K-100K
6.3~100V Below~68µF	1.00	1.20	1.30	1.50
6.3~100V 100~680µF	1.00	1.10	1.15	1.20
6.3~110V 1000~22000µF	1.00	1.05	1.10	1.15
160~450V Below~220µF	1.00	1.25	1.40	1.40
160~450V 220µF Above	1.00	1.10	1.13	1.13

Temperature Coefficient

TEMPERATURE (°C)	50	70	85
FACTOR	1.30	1.15	1.00

Dimensions: mm

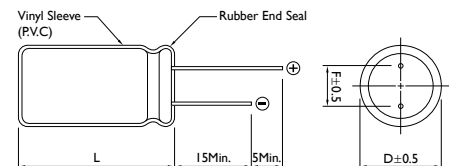

## CASE SIZE & PERMISSIBLE RIPPLE CURRENT OF STANDARD PRODUCTS

D x L: mm

CAP. (μF)	RATED VOLTAGE WV (SURGE VOLTAGE WV)													
	6.3 (8)		10 (13)		16 (20)		25 (32)		35 (44)		50 (63)		63 (79)	
	SIZE	RIPPLE	SIZE	RIPPLE	SIZE	RIPPLE	SIZE	RIPPLE	SIZE	RIPPLE	SIZE	RIPPLE	SIZE	RIPPLE
0.10											5 x 11	1		
0.22											5 x 11	2		
0.33											5 x 11	3	5 x 11	3
0.47											5 x 11	5	5 x 11	5
0.68											5 x 11	7		
1.0			5 x 11	10	5 x 11	10					5 x 11	10	5 x 11	10
2.2			5 x 11	20							5 x 11	23	5 x 11	29
3.3											5 x 11	35	5 x 11	40
4.7			5 x 11	20	5 x 11	25	5 x 11	30	5 x 11	35	5 x 11	40	5 x 11	45
6.8											5 x 11	50		
10			5 x 11	35	5 x 11	40	5 x 11	50	5 x 11	60	5 x 11	65	5 x 11	70
15					5 x 11	50					5 x 11	80		
22	5 x 11	35	5 x 11	55	5 x 11	75	5 x 11	90	5 x 11	95	5 x 11	100	5 x 11	95
													6.3 x 11	115
33	5 x 11	55	5 x 11	80	5 x 11	110	5 x 11	115	5 x 11	120	5 x 11	105	6.3 x 11	130
											6.3 x 11	125	8 x 11	140
47	5 x 11	75	5 x 11	95	5 x 11	130	5 x 11	135	5 x 11	120	6.3 x 11	140	6.3 x 11	160
							6.3 x 11	135	6.3 x 11	140	8 x 11	150	8 x 11	190
68					5 x 11	150	6.3 x 11	145	8 x 11	180				
100	5 x 11	130	5 x 11	180	5 x 11	165	6.3 x 11	160	6.3 x 11	185	8 x 11	230	10 x 12	300
					6.3 x 11	185	8 x 11	200	8 x 11	230	10 x 12	250	10 x 15	300
150					6.3 x 11	205								
220	5 x 11	200	5 x 11	215	6.3 x 11	260	8 x 11	290	8 x 11	290	10 x 12	380	10 x 15	410
	6.3 x 11	240	6.3 x 11	250	8 x 11	320	10 x 12	340	10 x 12	370	10 x 15	440	10 x 19.5	490
									10 x 15	370				
330	6.3 x 11	260	6.3 x 11	265	6.3 x 11	290	8 x 11	315	8 x 15	386	10 x 15	490	10 x 19.5	540
	8 x 11	300	8 x 11	330	8 x 11	360	8 x 15	380	10 x 12	420	10 x 19.5	580	13 x 20	680
							10 x 12	420	10 x 15	490	13 x 13	530		
470	6.3 x 11	330	6.3 x 11	320	8 x 11	400	8 x 15	420	10 x 15	430	10 x 19.5	610	13 x 20	755
	8 x 11	380	8 x 11	400	10 x 12	470	10 x 12	460	10 x 19.5	510	13 x 20	760	13 x 25	880
							10 x 15	540	13 x 20	640			16 x 25	880

Note: I. Ripple Current: (mA/rms) 85°C, 120Hz

## CASE SIZE & PERMISSIBLE RIPPLE CURRENT OF STANDARD PRODUCTS

D x L: mm

CAP. (μF)	RATED VOLTAGE WV (SURGE VOLTAGE WV)															
	6.3 (8)		10 (13)		16 (20)		25 (32)		35 (44)		50 (63)		63 (79)			
	SIZE	RIPPLE	SIZE	RIPPLE	SIZE	RIPPLE	SIZE	RIPPLE	SIZE	RIPPLE	SIZE	RIPPLE	SIZE	RIPPLE		
680	8 x 11	410	10 x 12	460	10 x 12	510	10 x 15	540	13 x 20	705			13 x 25	965		
					10 x 15	565	10 x 19.5	595	13 x 25	780			16 x 25	1085		
1000	8 x 11	460	10 x 12	580	10 x 12	530	10 x 19.5	760	10 x 19.5	770	13 x 25	1100	16 x 25	1310		
					10 x 15	630	10 x 15	630	12 x 16	760	13 x 20	950	16 x 25	1350	16 x 32	1550
					10 x 19.5	790	13 x 16	760	13 x 25	1100						
							13 x 20	950								
1200	10 x 12	620	10 x 15	754												
1500			10 x 19.5	700	13 x 16	825			16 x 25	1240						
2200	10 x 19.5	840	10 x 19.5	880	10 x 19.5	925	13 x 20	1100	16 x 25	1600	16 x 36	1850	18 x 40	2200		
					13 x 20	1050	13 x 20	1100	13 x 25	1300	16 x 32	1800	18 x 36	2090	22 x 35	2200
							13 x 25	1350	16 x 25	1550					22 x 40	2200
							18 x 20	1550								
3300	10 x 19.5	1000	13 x 20	1250	13 x 20	1200	16 x 25	1660	16 x 36	1970	18 x 36	2170	22 x 40	2500		
					13 x 20	1250	13 x 25	1400	13 x 25	1400	16 x 32	1950	18 x 36	2220	18 x 40	2400
							16 x 25	1700								
4700	13 x 20	1300	13 x 25	1500	13 x 40	1882	16 x 32	1950	16 x 36	2136	18 x 50	2350				
					13 x 25	1437	16 x 25	1800	16 x 25	1800	18 x 36	2360	18 x 36	2400	22 x 35	2240
					16 x 25	1700			16 x 32	2100				22 x 40	2500	
6800	16 x 25	1900	16 x 25	1900	16 x 32	1980	18 x 36	2550	18 x 40	2200						
					16 x 32	2150	16 x 36	2200			22 x 40	2600				
							18 x 36	2500								
10000	16 x 25	1900	16 x 36	2225	18 x 36	2700	22 x 40	2800								
					16 x 32	2250	18 x 36	2500								
15000	16 x 36	2500	18 x 36	2950	22 x 40	3150	22 x 40	3200								
					18 x 36	2880										
22000	18 x 40	3650	22 x 40	3700	22 x 40	3800										

Note: I. Ripple Current: (mA/rms) 85°C, 120Hz

## CASE SIZE & PERMISSIBLE RIPPLE CURRENT OF STANDARD PRODUCTS

D x L: mm

CAP. (μF)	RATED VOLTAGE WV (SURGE VOLTAGE WV)													
	100 (125)		160 (200)		200 (250)		250 (300)		350 (400)		400 (450)		450 (500)	
	SIZE	RIPPLE	SIZE	RIPPLE	SIZE	RIPPLE	SIZE	RIPPLE	SIZE	RIPPLE	SIZE	RIPPLE	SIZE	RIPPLE
0.22	5 x 11	5												
0.47	5 x 11	10	5 x 11	12	5 x 11	14	5 x 11	14	5 x 11	14	6.3 x 11	14	6.3 x 11	14
1.0	5 x 11	21	5 x 11	17	5 x 11	19	5 x 11	17	6.3 x 11	19	6.3 x 11	16	6.3 x 11	15
			6.3 x 11	17			6.3 x 11	19			8 x 11	19	8 x 11	19
2.2	5 x 11	30	6.3 x 11	26	6.3 x 11	22	6.3 x 11	24	8 x 11	33	8 x 11	26	10 x 12	33
					8 x 11	27	8 x 11	30	10 x 12	33	10 x 12	33		
3.3	5 x 11	45	6.3 x 11	30	6.3 x 11	30	8 x 11	30	8 x 11	33	10 x 12	40	10 x 15	42
			8 x 11	35	8 x 11	37	10 x 12	38	10 x 12	39				
4.7	5 x 11	50	6.3 x 11	32	8 x 11	36	8 x 11	36	8 x 11	36	10 x 15	45	10 x 15	50
			8 x 11	40	10 x 12	45	10 x 12	45	10 x 12	39			10 x 19.5	50
									10 x 15	45				
6.8	5 x 11	55					8 x 11	40					10 x 15	50
							10 x 12	50					10 x 19.5	50
10	5 x 11	65	8 x 11	50	10 x 12	57	10 x 15	70	10 x 15	70	10 x 15	50	13 x 20	60
	6.3 x 11	75	10 x 12	65	10 x 15	70	10 x 19.5	70	13 x 20	70	10 x 19.5	56	13 x 25	75
			10 x 15	65							13 x 20	70		
15	8 x 11	93					10 x 19.5	75	10 x 19.5	90			13 x 20	93
							13 x 20	90						
22	6.3 x 11	105	10 x 15	110	10 x 15	120	10 x 19.5	130	13 x 20	130	13 x 20	100	16 x 20	100
	8 x 11	130	10 x 19.5	110							13 x 25	110	16 x 25	110
											16 x 25	130	16 x 32	130
33	8 x 11	140	10 x 19.5	150	10 x 19.5	160	13 x 20	140	13 x 25	170	13 x 25	140	16 x 25	145
	10 x 12	170					13 x 25	160	16 x 25	170	16 x 20	145	16 x 32	160
											16 x 25	170	16 x 36	180
47	10 x 12	190	12 x 16	145	13 x 20	160	13 x 20	180	16 x 25	220	16 x 25	180	18 x 36	200
	10 x 15	230	12 x 25	180	13 x 25	190	13 x 25	210			16 x 32	220	18 x 40	230
			13 x 20	180			16 x 25	210			16 x 36	220		
68	10 x 15	280			13 x 25	230					18 x 25	236	18 x 32	265
100	10 x 19.5	400	13 x 25	250	16 x 25	330	16 x 32	310	16 x 36	320	16 x 36	320	22 x 40	370
			16 x 25	300					18 x 36	360	18 x 36	360		

Note: I. Ripple Current: (mA/rms) 85°C, 120Hz

## CASE SIZE & PERMISSIBLE RIPPLE CURRENT OF STANDARD PRODUCTS

D x L: mm

CAP. (μF)	RATED VOLTAGE WV (SURGE VOLTAGE WV)													
	100 (125)		160 (200)		200 (250)		250 (300)		350 (400)		400 (450)		450 (500)	
	SIZE	RIPPLE	SIZE	RIPPLE	SIZE	RIPPLE	SIZE	RIPPLE	SIZE	RIPPLE	SIZE	RIPPLE	SIZE	RIPPLE
150	13 x 20	500					18 x 40	410						
220	13 x 25	710	16 x 32	450	18 x 25	485	18 x 36	540			18 x 40	800		
			16 x 36	510	18 x 32	540	18 x 40	600						
					18 x 36	600								
330	13 x 25	720	18 x 36	540	16 x 40	710								
			16 x 25	860	18 x 40	600	16 x 45	750						
					18 x 32	685								
					18 x 36	725								
					18 x 40	800								
470	13 x 40	1100	22 x 40	900	18 x 40	750								
	16 x 25	1100			22 x 35	1000								
	16 x 32	1100												
680	16 x 36	1260												
1000	18 x 40	1350												
	22 x 35	1680												
2200	22 x 40	2300												

Note: I. Ripple Current: (mA/rms) 85°C, 120Hz

# Miniature Aluminum Electrolytic Capacitors

# SE-K [ For General ]

105°C Single-Ended Lead Aluminum Electrolytic Capacitors Rated Voltage up to 450V

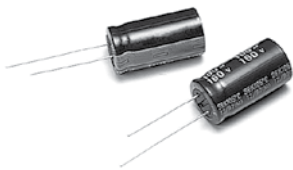

## DESCRIPTION

Lower-cost capacitors suitable for high density printed circuit boards.

Very high volumetric efficiency

Ideally suited for general purpose applications, coupling, decoupling, bypass, and filtering circuit in entertainment electronics.

Featuring high CV products with moderate cost

### MULTIPLIER FOR RIPPLE CURRENT

Frequency Coefficient

FREQUENCY (Hz)	120	300	1K	10K~100K
6.3~100V Below~68μF	1.00	1.20	1.30	1.45
6.3~100V 100~680μF	1.00	1.10	1.15	1.25
6.3~110V 1000~22000μF	1.00	1.05	1.10	1.15
160~450V ALL Cap(μF)	1.00	1.05	1.10	1.50

## ELECTRICAL CHARACTERISTICS

Operating Temperature Range : -40 ~ +105°C / -40 ~ +105°C / 25 ~ +105°C

Rated Voltage Range : 6.3 ~ 100V / 160 ~ 250V / 350 ~ 450V

Rated Capacitance Range : 0.47 ~ 15000μF / 0.47 ~ 470μF / 0.47 ~ 150μF

Capacitance Tolerance : -20 ~ +20% at 120Hz, 20°C

Leakage Current (μA) :  $I = 0.01CV (\mu A) + 3\mu A / 0.03CV (\mu A) + 10\mu A$  whichever is greater.  
(After Rated Voltage Applied for 2 Minutes)

Dissipation Factor

WV (V) :	6.3	10	16	25	35	50	63~100	160 ~ 250	350 ~ 450
D.F. (%) :	26	22	18	16	14	12	10	15	20

Endurance : After the rated voltage has been applied at 105°C for 1000 hours. The capacitors shall meet the following requirements.

- (a) Capacitance Change : Within 20% of Initial Value
- (b) Dissipation Factor : 200% or Less of Initial Specified Value
- (c) Leakage Current : Initial Specified Value or Less

Shelf Life : After leaving capacitors under no load at 105°C for 500 hours, the capacitors shall meet the same requirements as Endurance.

## DIAGRAM OF DIMENSIONS

Dimensions: mm

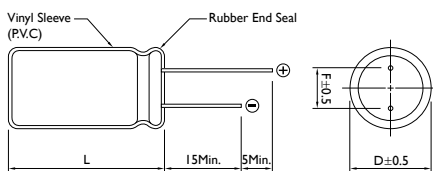

### Rubber Stand-off

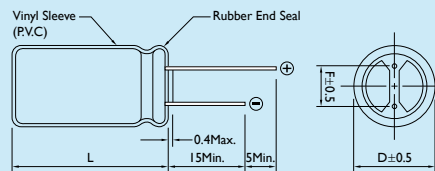

$L \leq 16 L + 1.5\text{Max.}$   
 $L > 16 L + 2\text{Max.}$   
 $D\phi = 8 \ \& \ 10 L + 2.5\text{Max.}$

$D\phi < 20 D\phi + 0.5$   
 $D\phi \geq 20 D\phi + 1$

Dø	F	dø
5.0	2.0	0.5
6.3	2.5	
8.0	3.5	0.6
10.0	5.0	
12.0		
13.0		
16.0	7.5	0.8
18.0		
22.0	10.0	0.8 (1.0)

## CASE SIZE & PERMISSIBLE RIPPLE CURRENT OF STANDARD PRODUCTS

D x L: mm

CAP. (μF)	RATED VOLTAGE WV (SURGE VOLTAGE WV)														
	6.3 (8)		10 (13)		16 (20)		25 (32)		35 (44)		50 (63)		63 (79)		
	SIZE	RIPPLE	SIZE	RIPPLE	SIZE	RIPPLE	SIZE	RIPPLE	SIZE	RIPPLE	SIZE	RIPPLE	SIZE	RIPPLE	
0.47											5 x 11	7	5 x 11	8	
0.68											5 x 11	7			
1.0											5 x 11	12	5 x 11	13	
2.2											5 x 11	18	5 x 11	20	
3.3											5 x 11	25	5 x 11	27	
4.7							5 x 11	20	5 x 11	25	5 x 11	30	5 x 11	34	
6.8							5 x 11	25	5 x 11	30	5 x 11	32	5 x 11	37	
10					5 x 11	25	5 x 11	30	5 x 11	40	5 x 11	50	5 x 11	55	
15					5 x 11	40	5 x 11	45	5 x 11	50	5 x 11	60	5 x 11	65	
22			5 x 11	45	5 x 11	55	5 x 11	60	5 x 11	65	5 x 11	75	5 x 11	75	
													6.3 x 11	90	
33			5 x 11	60	5 x 11	70	5 x 11	75	5 x 11	85	6.3 x 11	105	6.3 x 11	110	
													8 x 11	120	
47	5 x 11	60	5 x 11	75	5 x 11	85	5 x 11	90	5 x 11	95	6.3 x 11	105	6.3 x 11	128	
						6.3 x 11	97			6.3 x 11	115	8 x 11	125	8 x 11	155
68	5 x 11	75	5 x 11	80	5 x 11	100	6.3 x 11	125	8 x 11	130	8 x 11	159	10 x 12	198	
100	5 x 11	100	5 x 11	110	5 x 11	110	6.3 x 11	145	6.3 x 11	150	8 x 11	160	8 x 15	230	
			6.3 x 11	135	6.3 x 11	135	8 x 11	160	8 x 11	190	10 x 12	210	10 x 12	260	
150	5 x 11	120	5 x 11	110	8 x 11	180	8 x 11	200	10 x 12	240	10 x 12	289	10 x 15	330	
			6.3 x 11	130											
220	5 x 11	140	5 x 11	150	6.3 x 11	180	8 x 11	200	8 x 11	230	10 x 12	340	10 x 15	400	
	6.3 x 11	165	6.3 x 11	180	8 x 11	235	10 x 12	250	8 x 15	280	10 x 15	400	10 x 19.5	460	
									10 x 12	315					
270			8 x 11	210											
330	6.3 x 11	160	6.3 x 11	205	8 x 11	285	8 x 11	265	8 x 15	345	10 x 15	450	10 x 19.5	520	
	8 x 11	200	8 x 11	255			8 x 15	320	8 x 20	420	10 x 19.5	535	13 x 20	650	
							10 x 12	355	10 x 12	380					
									10 x 15	440					
470	6.3 x 11	220	6.3 x 11	245	8 x 11	310	8 x 15	365	10 x 15	415	10 x 19.5	580	13 x 20	700	
	8 x 11	280	8 x 11	305	8 x 15	360	10 x 12	400	10 x 19.5	490	13 x 20	730	13 x 25	800	
					10 x 12	395	10 x 15	470	13 x 20	580					
560									10 x 30	600					

Note: I. Ripple Current: (mA/rms) 105°C, 120Hz

## CASE SIZE & PERMISSIBLE RIPPLE CURRENT OF STANDARD PRODUCTS

D x L: mm

CAP. (μF)	RATED VOLTAGE WV (SURGE VOLTAGE WV)													
	6.3 (8)		10 (13)		16 (20)		25 (32)		35 (44)		50 (63)		63 (79)	
	SIZE	RIPPLE	SIZE	RIPPLE	SIZE	RIPPLE	SIZE	RIPPLE	SIZE	RIPPLE	SIZE	RIPPLE	SIZE	RIPPLE
680	8 x 11	255	8 x 11	335	10 x 12	455	10 x 15	540	10 x 19.5	600	13 x 25	860	13 x 25	840
	10 x 12	320	8 x 15	385	10 x 15	530	10 x 19.5	650	13 x 20	730			16 x 25	1000
			10 x 12	420										
1000	8 x 11	370	8 x 11	390	8 x 20	600	10 x 19.5	680	13 x 20	850	13 x 25	930	16 x 25	1020
	10 x 12	470	8 x 15	450	10 x 15	590	13 x 20	855	13 x 25	995	16 x 25	1110	16 x 32	1200
			10 x 12	490	10 x 19.5	700								
			10 x 15	570										
1500	10 x 15	600	10 x 19.5	750	10 x 19.5	680	13 x 25	1020	13 x 25	935	16 x 32	1350	16 x 32	1300
							13 x 20	860		16 x 25	1110		16 x 36	1450
2200	10 x 19.5	740	10 x 19.5	800	10 x 25	895	13 x 25	1030	16 x 25	1230	16 x 36	1360	18 x 36	1455
	13 x 20	930	13 x 20	1010	12 x 25	1040	16 x 25	1230	16 x 32	1450	18 x 36	1530		
					13 x 20	990								
					13 x 25	1150								
3300	10 x 19.5	880	10 x 25	950	13 x 25	1140	13 x 25	1035	16 x 36	1470	18 x 36	1540		
	13 x 20	1100	10 x 30	1090	16 x 25	1350	16 x 25	1230	18 x 36	1660	18 x 40	1700		
			13 x 20	1050			16 x 32	1450						
			13 x 25	1220										
4700	13 x 25	1100	13 x 25	1190	16 x 25	1330	16 x 32	1420	18 x 36	1580	22 x 35	1900		
	16 x 25	1320	16 x 25	1410	16 x 32	1560	18 x 36	1690	18 x 40	1750				
6800	13 x 25	1250	16 x 25	1370	16 x 32	1400	18 x 36	1850	18 x 40	1600				
	16 x 25	1490	16 x 32	1610	16 x 36	1590			22 x 40	1885				
					16 x 40	1670								
					18 x 32	1600								
					18 x 36	1790								
10000	16 x 25	1560	16 x 36	1760	18 x 36	2100								
	16 x 32	1830	18 x 36	1980										
15000	18 x 36	2280	18 x 40	1960										

Note: I. Ripple Current: (mA/rms) 105°C, 120Hz



## CASE SIZE & PERMISSIBLE RIPPLE CURRENT OF STANDARD PRODUCTS

D x L: mm

CAP. (μF)	RATED VOLTAGE WV (SURGE VOLTAGE WV)													
	100 (125)		160 (200)		200 (250)		250 (300)		350 (400)		400 (450)		450 (500)	
	SIZE	RIPPLE	SIZE	RIPPLE	SIZE	RIPPLE	SIZE	RIPPLE	SIZE	RIPPLE	SIZE	RIPPLE	SIZE	RIPPLE
0.47	5 x 11	10	5 x 11	12	5 x 11	14	5 x 11	14	5 x 11	14	6.3 x 11	14	6.3 x 11	14
1.0	5 x 11	15	5 x 11	17	5 x 11	19	6.3 x 11	19	6.3 x 11	20	6.3 x 11	16	8 x 11	20
											8 x 11	20		
2.2	5 x 11	22	6.3 x 11	25	6.3 x 11	22	6.3 x 11	23	8 x 11	35	8 x 11	28	10 x 12	35
					8 x 11	28	8 x 11	29			10 x 12	35		
3.3	5 x 11	29	6.3 x 11	30	6.3 x 11	32	8 x 11	33	8 x 11	37	8 x 11	38	10 x 15	54
			8 x 11	36	8 x 11	40	10 x 12	42	10 x 12	47	10 x 12	50		
4.7	5 x 11	37	6.3 x 11	34	8 x 11	40	8 x 11	41	8 x 11	37	8 x 11	40	10 x 15	60
			8 x 11	43	10 x 12	50	10 x 12	52	10 x 12	47	8 x 15	45		
									10 x 15	55	10 x 12	49		
											10 x 15	57		
6.8	5 x 11	46	10 x 12	54	10 x 12	60	8 x 15	57	10 x 15	65	10 x 15	60	10 x 19.5	70
							10 x 12	62			10 x 19.5	72		
10	5 x 11	55	8 x 11	56	10 x 12	69	10 x 15	88	10 x 15	95	10 x 15	65	10 x 19.5	75
	6.3 x 11	65	10 x 12	70	10 x 15	80	10 x 19.5	90			10 x 19.5	77	13 x 20	85
											13 x 20	97	13 x 25	100
15	8 x 11	82	10 x 15	90	10 x 15	110	10 x 15	120	10 x 19.5	140	10 x 19.5	100	16 x 25	160
											13 x 20	125		
											13 x 25	150		
22	8 x 11	115	8 x 20	125	10 x 15	140	10 x 19.5	155	13 x 20	165	13 x 20	150	13 x 25	125
			10 x 15	130							13 x 25	175	16 x 25	150
													16 x 32	180
33	8 x 11	120	10 x 19.5	180	10 x 19.5	190	13 x 20	170	13 x 25	220	13 x 25	190	16 x 25	190
	10 x 12	160					13 x 25	200			16 x 20	195	16 x 36	240
											16 x 25	230		
47	10 x 12	180	13 x 20	270	13 x 20	240	13 x 25	330	16 x 25	340	16 x 25	280	16 x 36	300
	10 x 15	210			13 x 25	290					16 x 32	315	18 x 40	360
											16 x 36	350		
											18 x 20	275		
											18 x 25	300		

Note: I. Ripple Current: (mA/rms) 105°C, 120Hz

## CASE SIZE & PERMISSIBLE RIPPLE CURRENT OF STANDARD PRODUCTS

D x L: mm

CAP. (μF)	RATED VOLTAGE WV (SURGE VOLTAGE WV)													
	100 (125)		160 (200)		200 (250)		250 (300)		350 (400)		400 (450)		450 (500)	
	SIZE	RIPPLE	SIZE	RIPPLE	SIZE	RIPPLE	SIZE	RIPPLE	SIZE	RIPPLE	SIZE	RIPPLE	SIZE	RIPPLE
68	10 x 15	241	13 x 25	300	13 x 25	330	16 x 25	350	16 x 32	370	16 x 32	320	18 x 32	305
											16 x 36	335	22 x 40	400
											18 x 25	305		
												18 x 36	380	
100	10 x 19.5	385	13 x 25	330	13 x 25	340	16 x 32	430	18 x 36	460	16 x 36	425	18 x 36	380
			16 x 25	400	16 x 25	410			18 x 32	430	18 x 40	400		
									18 x 36	480	22 x 40	450		
120										18 x 36	480			
150	13 x 25	414	16 x 32	435	16 x 32	400	18 x 40	460	22 x 40	480	22 x 40	450		
					16 x 36	450								
180											18 x 40	350		
220	13 x 25	590	16 x 32	550	18 x 32	520	22 x 40	680						
			16 x 36	620	18 x 36	580								
					18 x 40	650								
330	13 x 25	600	18 x 36	770	18 x 36	705								
	16 x 25	720	18 x 40	850	18 x 40	780								
					22 x 40	920								
470	16 x 25	740	22 x 40	980										
	16 x 32	875												
680	16 x 36	1200												
1000	18 x 40	1340												
	22 x 40	1500												

Note: I. Ripple Current: (mA/rms) 105°C, 120Hz

# SH [ For General ]

105°C Single-Ended Lead Aluminum Electrolytic Capacitors  
for the Rated Voltage up to 450V

## Miniature Aluminum Electrolytic Capacitors

### ELECTRICAL CHARACTERISTICS

Operating Temperature Range : -40 ~ +105°C / -25 ~ +105°C

Rated Voltage Range : 6.3 ~ 100V / 160 ~ 450V

Rated Capacitance Range : 0.47 ~ 15000μF / 0.47 ~ 470μF

Capacitance Tolerance : -20 ~ +20% at 120Hz, 20°C

Leakage Current (μA) :  $I = 0.01CV (\mu A) + 3\mu A / 0.03CV (\mu A) + 10\mu A$   
(After Rated Voltage Applied for 2 Minutes )

Dissipation Factor

WV (V) :	6.3	10	16	25	35	50	63 ~ 100	160 ~ 250	350 ~ 450
D.F (%) :	26	22	18	16	14	12	10	15	20

For capacitors whose capacitance exceeds 1000μF. The value of DF(%) is increased by 2% for every addition of 1000μF.

Low Temperature Stability Impedance Ratio (Max.)

WV (V) :		6.3	10	16	25 ~ 100	160 ~ 250	350 ~ 450
Impedance :	Z - 25°C / Z + 25°C	4	3	2	2	4	4
	Z - 40°C / Z + 20°C	8	6	4	3	-	-

Endurance : After the rated voltage has been applied at 105°C for 2000 hours, the capacitors shall meet following requirements.

- (a) Capacitance Change : Within 20% of Initial Value
- (b) Dissipation Factor : 200% or Less of Initial Specified Value
- (c) Leakage Current : Initial Specified Value or Less

Shelf Life: After leaving capacitors under no load at 105°C for 1000 hours, the capacitors shall meet the same requirements as Endurance.

### DIAGRAM OF DIMENSIONS

Dø	F	dø
5.0	2.0	0.5
6.3	2.5	
8.0	3.5	0.6
10.0	5.0	
12.0		
13.0		
16.0	7.5	0.8
18.0		
22.0	10.0	

Rubber Stand-off

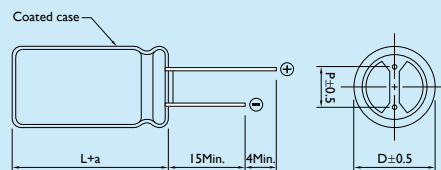

$L \leq 16$   $L + 1.5Max.$   $D\phi < 20$   $D\phi + 0.5$   
 $L > 16$   $L + 2Max.$   $D\phi \geq 20$   $D\phi + 1$   
 $D\phi = 8 \ \& \ 10$   $L + 2.5Max.$

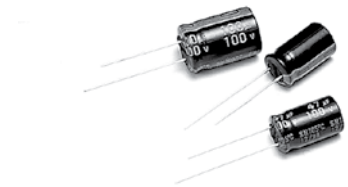

### DESCRIPTION

Long life for 2000 hours at 105°C, ideally suited for high quality and high reliability applications.

Featuring high CV products

### MULTIPLIER FOR RIPPLE CURRENT

Frequency Coefficient

FREQUENCY (Hz)	120	300	1K	10K~100K
6.3~100V Below~68μF	1.00	1.30	1.57	2.00
6.3~100V 100~470μF	1.00	1.23	1.34	1.50
6.3~100V 471~22000μF	1.00	1.10	1.13	1.15
160~450V ALL Cap(μF)	1.00	1.25	1.40	1.60

Temperature Coefficient

TEMPERATURE (°C)	65	85	105
FACTOR	1.70	1.40	1.00

Dimensions: mm

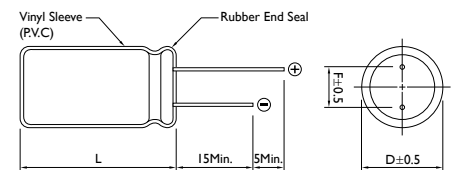

## CASE SIZE & PERMISSIBLE RIPPLE CURRENT OF STANDARD PRODUCTS

D x L: mm

CAP. (μF)	RATED VOLTAGE WV (SURGE VOLTAGE WV)									
	6.3 (8) SIZE		10 (13) SIZE		16 (20) SIZE		25 (32) SIZE		35 (44) SIZE	
		RIPPLE		RIPPLE		RIPPLE		RIPPLE		RIPPLE
10					5 x 11	44	5 x 11	43	5 x 11	44
15									5 x 11	50
22							5 x 11	60	5 x 11	65
33					5 x 11	70	5 x 11	75	5 x 11	85
47			5 x 11	75	5 x 11	85	5 x 11	90	6.3 x 11	115
68			5 x 11	80	5 x 11	100	6.3 x 11	125	8 x 11	130
100	5 x 11	100	5 x 11	110	5 x 11	115	6.3 x 11	145	6.3 x 11	170
					6.3 x 11	135			8 x 11	205
150	5 x 11	120	6.3 x 11	130	8 x 11	180	8 x 11	200	8 x 11	220
									10 x 12	240
220	6.3 x 11	165	6.3 x 11	180	6.3 x 11	180	8 x 11.5	240	10 x 12	315
					8 x 11	235	10 x 12	280		
330	6.3 x 11	161	8 x 11	255	8 x 11	315	8 x 11.5	340	10 x 12	400
	8 x 11	200			10 x 12	285	10 x 12	355	10 x 15	440
470	6.3 x 11	225	8 x 11	305	8 x 11	315	10 x 12	470	10 x 15	480
	8 x 11	280			10 x 12	395	10 x 15	520	10 x 19.5	570
									13 x 20	590
680	10 x 12	320	10 x 12	420	10 x 15	530	10 x 15	620	10 x 20	650
							10 x 19.5	650	13 x 20	730
1000	10 x 12	470	10 x 12	490	10 x 19.5	700	10 x 20	820	13 x 25	995
			10 x 15	570			13 x 20	900	13 x 20	900
1500	10 x 15	600	10 x 19.5	750	10 x 19.5	705	13 x 25	1050	13 x 25	1050
					13 x 20	860			16 x 25	1110
2200	13 x 20	930	10 x 19.5	800	13 x 20	1110	13 x 25	1175	16 x 25	1370
			13 x 20	1010	13 x 25	1250	16 x 25	1370	16 x 32	1450
3300	13 x 20	1100	13 x 25	1220	13 x 25	1390	16 x 32	1450	16 x 36	1477
					16 x 25	1530			18 x 36	1660
4700	16 x 25	1320	16 x 25	1410	16 x 25	1740	18 x 36	1690	18 x 36	1920
6800	16 x 25	1490	16 x 32	1610	16 x 30	2080			18 x 40	2400
10000	16 x 32	1830	18 x 36	1980	16 x 35	2380				
15000	18 x 36	2280								

Note: I. Ripple Current: (mA/rms) 105°C, 120Hz

## CASE SIZE & PERMISSIBLE RIPPLE CURRENT OF STANDARD PRODUCTS

D x L: mm

CAP. (μF)	RATED VOLTAGE WV (SURGE VOLTAGE WV)									
	50 (63) SIZE		63 (79) SIZE		100 (125) SIZE		160 (200) SIZE		200 (250) SIZE	
		RIPPLE		RIPPLE		RIPPLE		RIPPLE		RIPPLE
0.47	5 x 11	7	5 x 11	8	5 x 11	10	5 x 11	12	5 x 11	12
1.0	5 x 11	12	5 x 11	12	5 x 11	15	5 x 11	17	6.3 x 11	17
2.2	5 x 11	18	5 x 11	20	5 x 11	22	6.3 x 11	25	6.3 x 11	25
3.3	5 x 11	25	5 x 11	27	5 x 11	29	8 x 11	36	8 x 11	36
4.7	5 x 11	30	5 x 11	34	5 x 11	37	6.3 x 11	34	6.3 x 11	50
							8 x 11	43	8 x 11	53
6.8	5 x 11	30	5 x 11	37	5 x 11	46	10 x 12	54	10 x 12	60
10	5 x 11	50	5 x 11	55	6.3 x 11	65	10 x 12	70	8 x 11.5	69
									10 x 12	80
15	5 x 11	50	5 x 11	65	8 x 11	82	10 x 15	90	10 x 19.5	110
22	5 x 11	75	6.3 x 11	90	8 x 11	115	10 x 15	115	10 x 15	140
							10 x 19.5	130	10 x 19.5	150
33	6.3 x 11	105	8 x 11	110	10 x 12	160	10 x 20	160	13 x 20	220
							13 x 20	180	13 x 25	190
47	6.3 x 11	101	8 x 11	155	10 x 15	210	10 x 20	195	10 x 25	220
	8 x 11	125					13 x 25	250	13 x 20	260
68	8 x 11	159	10 x 12	198	10 x 15	240	13 x 20	255	13 x 20	280
					10 x 19.5	241	13 x 25	270	13 x 25	285
100	8 x 11	200	10 x 12	260	10 x 19.5	305	13 x 25	350	16 x 25	350
	10 x 12	210			13 x 20	345				
150	10 x 12	289	10 x 15	330	13 x 20	370	16 x 25	435	16 x 36	450
220	10 x 12	360	10 x 19.5	465	13 x 25	495	16 x 32	550	16 x 36	675
	10 x 15	415			16 x 25	590	18 x 32	685		
330	10 x 19.5	535	13 x 20	650	16 x 25	720	18 x 36	800	18 x 36	750
	13 x 20	600							22 x 40	920
470	10 x 19.5	630	13 x 20	700	16 x 32	875	18 x 40	980	18 x 45	800
	13 x 20	730	13 x 25	800	22 x 40	920				
680	13 x 20	800	13 x 25	1000	16 x 36	1200				
	13 x 25	860	16 x 25	1160						
1000	13 x 25	1060	16 x 25	1250	18 x 40	2020				
			16 x 32	1350						
1500	16 x 25	1300	16 x 36	1450						
	16 x 32	1350								
2200	16 x 36	1600	18 x 36	1650						
			18 x 45	1800						
3300	18 x 36	1780								

Note: I. Ripple Current: (mA/rms) 105°C, 120Hz

## CASE SIZE & PERMISSIBLE RIPPLE CURRENT OF STANDARD PRODUCTS

D x L: mm

CAP. (μF)	RATED VOLTAGE WV (SURGE VOLTAGE WV)							
	250 (300) SIZE		350 (400) SIZE		400 (450) SIZE		450 (500) SIZE	
		RIPPLE		RIPPLE		RIPPLE		RIPPLE
0.47	5 x 11	12	6.3 x 11	14	6.3 x 11	14	6.3 x 11	16
1.0	6.3 x 11	17	6.3 x 11	15	6.3 x 11	17	6.3 x 11	18
			8 x 11	20	8 x 11	20	8 x 11	22
2.2	6.3 x 11	23	10 x 12	35	6.3 x 11	29	8 x 11	30
	8 x 11	29			8 x 11	31	10 x 12	37
3.3	6.3 x 11	37	8 x 11	42	10 x 12	42	8 x 11	40
	8 x 11	42			10 x 15	49	10 x 12	40
4.7	8 x 11	41	8 x 11	50	8 x 11	47	10 x 12	52
	10 x 12	52	10 x 8	55	10 x 15	57	8 x 16	58
6.8	8 x 11	62	8 x 12	60	8 x 12	75	10 x 15	62
			10 x 12	65	10 x 8.5	70		
10	8 x 15	80	10 x 12	85	10 x 12.5	105	10 x 19.5	85
	10 x 12.5	88	10 x 15	95	10 x 20	110		
15	10 x 15	110	10 x 20	140	10 x 20	140	13 x 20	120
22	10 x 20	140	10 x 25	150	10 x 25	150	13 x 25	200
	13 x 20	130	13 x 20	200	13 x 20	120		
33	13 x 20	200	13 x 25	260	13 x 25	200	16 x 20	210
							16 x 25	250
47	13 x 25	228	16 x 20	260	16 x 25	300	16 x 25	260
	16 x 25	270	18 x 25	360				
56	12.5 x 25	285	16 x 25	300	16 x 25	400	16 x 30	430
68	13 x 25	290	18 x 36	320	16 x 30	410	16 x 35	450
	16 x 20	300			18 x 25	390		
82	16 x 25	330	16 x 30	310	16 x 35	400	16 x 40	495
100	16 x 25	380	16 x 35	400	16 x 35	480	18 x 35	500
120	16 x 30	400	16 x 40	520	18 x 32	520	18 x 40	565
150	16 x 32	420	16 x 35	400	16 x 35	480	18 x 45	650
180	18 x 36	440	18 x 32	460	18 x 32	550	22 x 40	880
					22 x 40	600		
120			16 x 40	520	18 x 32	520	18 x 45	420
					18 x 36	550		
					18 x 40	600		
150	18 x 40	600	18 x 40	620	18 x 40	620		
220	22 x 40	800						

Note: I. Ripple Current: (mA/rms) 105°C, 120Hz

# SG [ Electronic Ballast ]

105°C 5000 Hours, High Voltage, High Ripple Current, Long Life

## Miniature Aluminum Electrolytic Capacitors

### ELECTRICAL CHARACTERISTICS

Operating Temperature Range : -40 ~ +105°C / -25 ~ +105°C

Rated Voltage Range : 160 ~ 250V / 350 ~ 500V

Rated Capacitance Range : 4.7 ~ 330µF / 3.3~100µF

Capacitance Tolerance : -20 ~ +20% at 120Hz, 20°C

DC Leakage Current (µA):  $I = 0.06CV (\mu A) + 10\mu A$  whichever is greater.  
(After Rated Voltage Applied for 2 Minutes)

Dissipation Factor

WV (V) :	16	200	250	350	400	450	500
D.F. (%) :	15	15	15	20	24	24	24

Low Temperature Stability Impedance Ratio (Max.)

WV (V) :	160	200	250	350	400	450	500
Z - 25°C / Z + 20°C	3	3	3	5	5	6	7
Z - 40°C / Z + 20°C	4	4	4	4	6	-	-

Endurance : After the rated voltage and rated ripple current have been applied at 105°C for 5000 hours, the capacitors shall meet the following requirements.

- (a) Capacitance Change : Within 20% of Initial Value
- (b) Dissipation Factor : 200% or Less of Initial Specified Value
- (c) Leakage Current : Initial Specified Value or Less

Shelf Life : After having been placed at 105°C without voltage applied for 1000 hours, the capacitors shall meet the same requirements as Endurance.



### MULTIPLIER FOR RIPPLE CURRENT

Frequency Coefficient

FREQUENCY (Hz)	50	60	120	300
6.3~100V Below~68µF	0.8	0.8	1.0	1.2
FREQUENCY (Hz)	1K	10K~100K		
6.3~100V Below~68µF	1.4	1.6		

### FEATURE

105°C 5000 Hours

High voltage, high ripple current

Long Lif

### DIAGRAM OF DIMENSIONS

Dimensions: mm

Dø	F	dø
5.0	2.0	0.5
6.3	2.5	
8.0	3.5	0.6
10.0	5.0	
12.0		
13.0		
16.0	7.5	0.8
18.0		
22.0	10.0	0.8 (1.0)

Rubber Stand-off

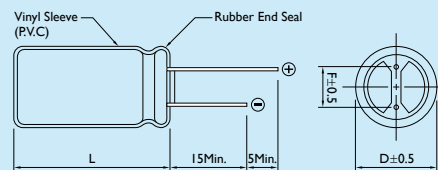

$L \leq 16$   $L + 1.5\text{Max.}$   $Dø < 20$  :  $Dø+0.5$   
 $L > 16$   $L + 2\text{Max.}$   $Dø \geq 20$  :  $Dø+1$   
 $Dø = 8 \ \& \ 10$   $L + 2.5\text{Max.}$

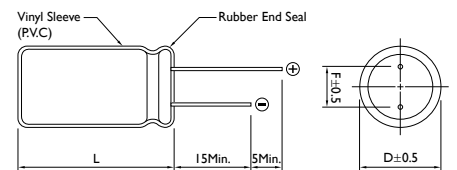

## CASE SIZE & PERMISSIBLE RIPPLE CURRENT OF STANDARD PRODUCTS

D x L: mm

CAP. (μF)	RATED VOLTAGE WV (SURGE VOLTAGE WV)					
	160 (200) SIZE		200 (250) SIZE		250 (300) SIZE	
		RIPPLE		RIPPLE		RIPPLE
10			*10 x 15	80	*10 x 15	85
					*10 x 19.5	100
15			*10 x 15	100		
22	10 x 19.5	160	10 x 19.5	160	*10 x 16	130
					10 x 20	200
33	10 x 19.5	210	*10 x 19.5	160	13 x 20	210
			13 x 20	210	13 x 25	230
47	13 x 20	260	13 x 20	260	13 x 25	270
					16 x 20	275
68	13 x 25	360	13 x 25	360	16 x 25	380
	16 x 20	430	16 x 20	430	18 x 20	375
100	16 x 25	475	16 x 25	475	16 x 32	520
	18 x 20	465	18 x 20	465	18 x 25	500
150	16 x 32	650	18 x 25	650	18 x 32	650
	18 x 25	625	16 x 30	750		
220	16 x 32	750	18 x 32	780	18 x 40	820
	18 x 25	725				
330	16 x 25	725				
	18 x 32	960				

Note: 1. Ripple Current: (mA/rms) 105°C, 120Hz

2. \*Down size: 3000 Hours



## CASE SIZE & PERMISSIBLE RIPPLE CURRENT OF STANDARD PRODUCTS

D x L: mm

CAP. (μF)	RATED VOLTAGE WV (SURGE VOLTAGE WV)							
	350 (400)		400 (450)		450 (500)		500 (550)	
	SIZE	RIPPLE	SIZE	RIPPLE	SIZE	RIPPLE	SIZE	RIPPLE
3.3					10 x 19.5	60	10 x 19	65
4.7			*10 x 15	60	13 x 20	80	12.5 x 20	80
6.8			*10 x 15	72	*10 x 19.5	90		
10	10 x 19.5	100	10 x 15	100	10 x 20	110	12.5 x 20	120
			10 x 19.5	135	12.5 x 20	110	12.5 x 25	130
22	13 x 20	160	13 x 20	170	12.5 x 20	145	13 x 20	180
			16 x 20	200	8 x 40	135	18 x 25	220
			8 x 40	140	10 x 35	165		
33	13 x 25	230	8 x 50	190	12 x 35	230	16 x 31.5	280
	16 x 20	250	10 x 40	190	16 x 25	235	18 x 25	295
			16 x 20	230	16 x 32	275		
			16 x 25	250	18 x 25	280		
47	16 x 25	300	16 x 32	300	12.5 x 45	310	16 x 36	430
	18 x 20	315	18 x 25	325	18 x 32	340	18 x 32	435
					10 x 52	295		
56	12.5 x 40	300	12.5 x 45	300	12.5 x 50	355		
68	12.5 x 45	350	16 x 32	350	12.5 x 55	410	18 x 32	530
	16 x 30	400	18 x 36	420	16 x 40	460	18 x 36	555
					18 x 25	335		
82	16 x 35	500	16 x 40	400	18 x 35	470	18 x 40	640
			12.5 x 55	400			22 x 35	675
100	18 x 32	530	18 x 32	545	18 x 40	580	22 x 35	745
	12.5 x 55	460	18 x 35	545	22 x 40	680		
120	18 x 36	590	18 x 40	550	18 x 45	700	22 x 40	865
150	18 x 40	650	22 x 40	650	22 x 40	850		

Note: 1. Ripple Current: (mA/rms) 105°C, 120Hz

2. \*Down size: 3000 Hours

# SP [ High Temperature ]

Long Life at 105°C 8,000hrs~10,000hrs

## Miniature Aluminum Electrolytic Capacitors

### ELECTRICAL CHARACTERISTICS

Operating Temperature Range : -40 ~ +105°C / -25 ~ +105°C

Rated Voltage Range : 160 ~ 500V

Rated Capacitance Range : 3.3 ~ 330μF

Capacitance Tolerance : -20 ~ +20% at 120Hz, 20°C

DC Leakage Current (μA) :  $I = 0.04CV (\mu A) + 100\mu A$  whichever is greater.  
(After Rated Voltage Applied for 2 Minutes)

Dissipation Factor

WV (V) :	160	200	400	450	500
D.F (%) :	20	20	24	24	24

Low Temperature Stability Impedance Ratio (Max.)

WV (V) :	160	200	400	450	500
Z - 25°C / Z + 20°C	3	3	5	6	6
Z - 40°C / Z + 20°C	6	6	6	8	-

Endurance: The following specifications shall be satisfied when the capacitors are stored at 20°C after subjected to DC Voltage with the maximum ripple current which is applied for 10,000 hours (8000 hours for 10ø) at 105°C.

- (a) Capacitance Change : Within 20% of Initial Value
- (b) Dissipation Factor : Not Exceeding 200% of Initial Requirement
- (c) Leakage Current : Not Exceeding the Initial Requirement

Shelf Life : After having been placed at 105°C without voltage applied for 1000 hours, the capacitors shall meet the same requirements as Endurance.

### DIAGRAM OF DIMENSIONS

Dø	F	dø
10.0	5.0	0.6
12.0		
13.0		
16.0	7.5	0.8
18.0		
22.0	10.0	

Rubber Stand-off

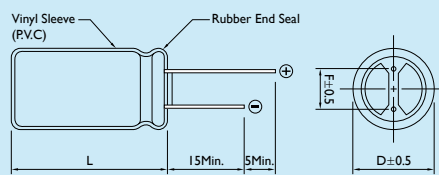

$L \leq 16 L + 1.5\text{Max.}$   
 $L > 16 L + 2\text{Max.}$   
 $D\phi = 8 \& 10 L + 2.5\text{Max.}$

$D\phi < 20 \quad D\phi + 0.5$   
 $D\phi \geq 20 \quad D\phi + 1$

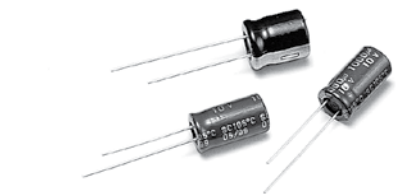

### DESCRIPTION

Applicable for Electronic Ballast

High Temperature Load Life at 105°C for 8000~10000 Hours

### MULTIPLIER FOR RIPPLE CURRENT

Frequency Coefficient

FREQUENCY (Hz)	120	1K	10K	100K
COEFFICIENT	1	1.6	1.8	2

Temperature Coefficient

TEMPERATURE (°C)	65	85	105
FACTOR	1.70	1.40	1.00

Dimensions: mm

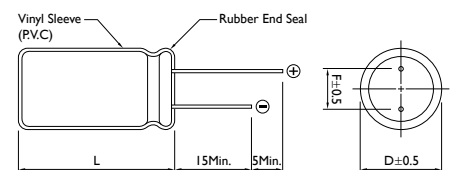

## CASE SIZE & PERMISSIBLE RIPPLE CURRENT OF STANDARD PRODUCTS

D x L: mm

<b>CAP.</b>														
<b>RATED VOLTAGE WV (SURGE VOLTAGE WV)</b>														
<b>(μF)</b>														
<b>160 (200)</b>		<b>200 (250)</b>		<b>250</b>		<b>400 (450)</b>		<b>420 (470)</b>		<b>450 (500)</b>		<b>500</b>		
SIZE	RIPPLE	SIZE	RIPPLE	SIZE	RIPPLE	SIZE	RIPPLE	SIZE	RIPPLE	SIZE	RIPPLE	SIZE	RIPPLE	
3.3									8x11.5	100	10x15	100		
4.7	8x11.5	85	8x11.5	130	8x11	135			8x11.5	110	10x19.5	140		
6.8	8x11.5	105	8x11.5	145	8x11	160	10x12.5	170	8x20	180	10x16	150		
									10x16	220	10x20	220		
8.2	8x11.5	115	8x11.5	165	8x12	170	8x20	240	10x16	252	10x20	265		
10	8x16	135	8x12	175	8x16	250	10x16	250	10x19.5	180	12.5x20	310	12.5x20	260
22	8x20	390	10x19.5	440	10x20	475	12.5x20	475	12.5x25	475	16x20	550	12.5x35	460
							8x50	475	8x50	475	18x20	550	16x25	460
33	10x19.5	500	10x19.5	520	12.5x20	570	12.5x25	570	16x25	610	16x25	665	16x30	600
	12.5x15	570	12.5x20	580			10x50	570	10x50	610	10x45	600	18x25	590
39	12.5x20	620					10x45	520	10x45	520	10x50	680	16x36	710
47	10x19.5	580	12.5x20	660	12.5x25	650	16x25	800	12.5x40	620	16x35	730	16x40	820
	12.5x20	660	8x50	650					16x32	700	18x32	880	18x30	770
											12.5x50	730		
56	12.5x20	740	12.5x25	670	12.5x30	750	16x30	820	16x30	820	16x35	750	18x36	910
	8x50	740	10x50	670					12.5x50	820				
68	12.5x25	720	13x25	720	12.5x30	870	12.5x50	880	18x30	870	16x35	970	18x40	1030
	16x20	760	16x20	760	10x50	870			12.5x50	800	12.5x55	1060		
100	13x25	970	16x25	1120	12.5x50	960	18x35	1120	18x40	1100				
	16x20	1120	10x45	660	16x30	960								
	16x25	1120												
	18x20	1120												
120	16x25	1240	10x50	860	18x30	1210	18x35	1200						
	16x25	1240	16x30	1090										
150	10x45	820												
	16x25	1200	16x32	1280										
	16x32	1300												
	18x25	1300												
180	10x50	940	12.5x50	1180										
220	16x32	1300	12.5x52	1300										
	18x25	1300	18x35	1420										
270	12.5x50	1280	12.5x55	1500										
330	12.5x55	1480												
	18x36	1380												

Note: I. Ripple Current: (mA/rms) 105°C, 100KHz

# SN [Non-Polar]

105°C 1000 hrs Non-Polar High Temperature

## Miniature Aluminum Electrolytic Capacitors

### ELECTRICAL CHARACTERISTICS

Operating Temperature Range : -40 ~ +105°C / -25 ~ +105°C

Rated Voltage Range : 6.3 ~ 50V

Rated Capacitance Range : 0.22 ~ 2200 $\mu$ F

Capacitance Tolerance : -20 ~ +20% at 120Hz, 20°C

DC Leakage Current ( $\mu$ A) :  $I = 0.03 CV + 3\mu A$   
(After Rated Voltage Applied for 2 Minutes)

Dissipation Factor

WV (V) :	6.3	10	16	25	35	50
D.F. (%) :	24	20	17	15	14	12

For capacitors whose capacitance exceeds 1000 $\mu$ F. The value of D.F is increased by 2% for every addition of 1000 $\mu$ F.

Endurance : 1000 Hours at 105°C with the Polarity Inverted Every 250 Hours

- (a) Capacitance Change : Within 25% of Initial Value
- (b) Dissipation Factor : Not Exceeding 200% of Specified Value
- (c) Leakage Current : Not Exceeding the Specified Value

Shelf Life : After having been placed at 105°C without voltage applied for 500 hours, the capacitors shall meet the same requirements as Endurance.

### DIAGRAM OF DIMENSIONS

D $\phi$	F	d $\phi$
4.0	1.5	0.45
5.0	2.0	0.5
6.3	2.5	
8.0	3.5	0.6
10.0	5.0	
12.0		
13.0		
16.0	7.5	0.8
18.0		
22.0	10.0	

Rubber Stand-off

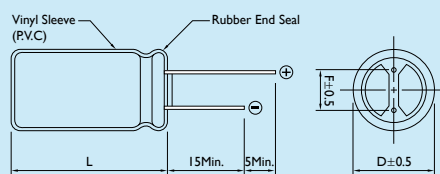

$L \leq 16$   $L + 1.5\text{Max.}$   
 $L > 16$   $L + 2\text{Max.}$   
 $D\phi = 8 \ \& \ 10$   $L + 2.5\text{Max.}$

$D\phi < 20$   $D\phi + 0.5$   
 $D\phi \geq 20$   $D\phi + 1$



### DESCRIPTION

Non-polar for used in reversing polarity DC voltage circuits.

### MULTIPLIER FOR RIPPLE CURRENT

Frequency Coefficient

FREQUENCY (Hz)	60	120	300	1K	10K
FACTOR	0.75	1.00	1.20	1.32	1.65

Temperature Coefficient

TEMPERATURE (°C)	65	85	105
FACTOR	1.30	1.20	1.00

Dimensions: mm

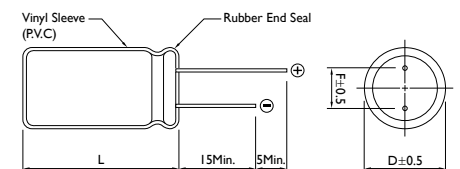

## CASE SIZE & PERMISSIBLE RIPPLE CURRENT OF STANDARD PRODUCTS

D x L: mm

CAP. (μF)	RATED VOLTAGE WV (SURGE VOLTAGE WV)											
	6.3 (8)		10 (13)		16 (20)		25 (32)		35 (44)		50 (63)	
	SIZE	RIPPLE	SIZE	RIPPLE	SIZE	RIPPLE	SIZE	RIPPLE	SIZE	RIPPLE	SIZE	RIPPLE
0.22											5 x 11	5
0.47											5 x 11	11
1.0											5 x 11	17
2.2											5 x 11	25
3.3											6.3 x 11	31
4.7									5 x 11	34	5 x 11	34
											6.3 x 11	41
10					6.3 x 11	45	5 x 11	42	6.3 x 11	54	6.3 x 11	56
							6.3 x 11	50			8 x 11	70
22			5 x 11	57	5 x 11	59	6.3 x 11	69	8 x 11	94	6.3 x 11	75
					6.3 x 11	69	8 x 11	86			8 x 11	97
											10 x 12	115
33	5 x 11	63	6.3 x 11	77	8 x 11	98	8 x 11	105	10 x 12	125	8 x 11	110
											10 x 15	150
47	6.3 x 11	84	6.3 x 11	93	8 x 11	115	10 x 12	140	10 x 15	165	8 x 11	130
											10 x 19.5	190
100	8 x 11	140	8 x 11	193	8 x 11	140	10 x 19.5	240	13 x 20	285	13 x 20	310
					10 x 12	175						
					10 x 15	205						
220	10 x 12	235	10 x 15	255	10 x 19.5	330	13 x 20	390	16 x 25	520	16 x 25	570
330	10 x 15	310	10 x 19.5	380	13 x 20	445	16 x 25	580	16 x 25	630	16 x 36	790
470	10 x 19.5	400	13 x 20	470	13 x 25	570	16 x 25	690	16 x 32	820		
1000	13 x 25	690	16 x 25	885	16 x 32	1020						
2200	16 x 32	1250	16 x 36	1450								

Note: I. Ripple Current: (mA/rms) 105°C, 120Hz

# SB [ Low Leakage Current ]

105°C 1000 hrs, Very Low Leakage Current

## Miniature Aluminum Electrolytic Capacitors

### ELECTRICAL CHARACTERISTICS

Operating Temperature Range : -40 ~ +105°C

Rated Voltage Range : 6.3 ~ 100V

Rated Capacitance Range : 0.1 ~ 4700µF

Capacitance Tolerance : -20 ~ +20% at 120Hz, 20°C

DC Leakage Current (µA) : I = 0.002CV (µA) or 0.4µA whichever is greater.  
(After Rated Voltage Applied for 2 Minutes)

Dissipation Factor

WV (V) :	6.3	10	16	25	35	50 ~ 100
D.F. (%) :	24	20	16	14	12	10

When nominal capacitance is over 1000µF, tan δ shall be added 0.02 to the listed value with increase of every 1000µF

Low Temperature Stability Impedance Ratio (Max.)

WV (V) :		6.3	10	16 ~ 25	35 ~ 63	80 ~ 100
Impedance : Z(120Hz) Z - 25°C / Z + 20°C		4	3	2	2	1.5
Z(120Hz) Z - 40°C / Z + 20°C		8	6	4	3	2

Endurance: After the rated voltage has been applied at 105°C for 1000 hours, the capacitors shall meet the following requirements.

- (a) Capacitance Change : Within 25% of Initial Value
- (b) Dissipation Factor : Not Exceeding 200% of Specified Value
- (c) Leakage Current : Not Exceeding the Specified Value

Shelf Life : After having been placed at 105°C without voltage application for 500 hours,

- (a) Capacitance Change : Within 25% of Initial Value
- (b) Dissipation Factor : Not Exceeding 200% of Specified Value
- (c) Leakage Current : Not Exceeding 200% of Specified Value

### DIAGRAM OF DIMENSIONS

Dø	F	dø
4.0	1.5	0.45
5.0	2.0	0.5
6.3	2.5	
8.0	3.5	0.6
10.0	5.0	
12.0		
13.0		
16.0	7.5	0.8
18.0		
22.0	10.0	

Rubber Stand-off

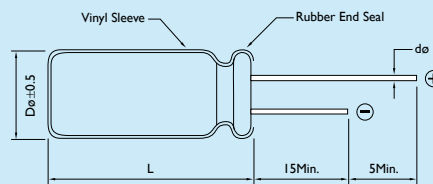

L ≤ 16 L + 1.5Max.  
L > 16 L + 2Max.  
Dø = 8 & 10 L + 2.5Max.



### DESCRIPTION

Used in where low leakage current is essential as in coupling of pre-amplifies.

Very low leakage current remains even after prolonged storage.

### MULTIPLIER FOR RIPPLE CURRENT

Frequency Coefficient

FREQUENCY (Hz)	50	120	300	1K	10K
6.3~25V	0.85	1.00	1.04	1.08	1.19
26~50V	0.80	1.00	1.30	1.40	1.43
50~100V	0.77	1.00	1.34	1.43	1.48

Temperature Coefficient

TEMPERATURE (°C)	60	70	85	105
FACTOR	1.95	1.75	1.20	1.00

Dimensions: mm

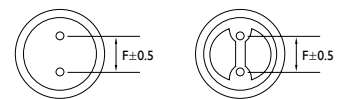

Dø < 20 Dø + 0.5  
Dø ≥ 20 Dø + 1

## CASE SIZE & PERMISSIBLE RIPPLE CURRENT OF STANDARD PRODUCTS

D × L: mm

CAP. (μF)	RATED VOLTAGE WV (SURGE VOLTAGE WV)							
	6.3 (8) SIZE		10 (13) SIZE		16 (20) SIZE		25 (32) SIZE	
		RIPPLE		RIPPLE		RIPPLE		RIPPLE
2.2								
3.3								
4.7							5 × 11	26
10					5 × 11	35	5 × 11	38
22			5 × 11	49	5 × 11	54	5 × 11	57
33	5 × 11	54	5 × 11	60	5 × 11	64	5 × 11	69
47	5 × 11	65	5 × 11	70	5 × 11	99	5 × 11	82
100	5 × 11	95	5 × 11	105	6.3 × 11	125	6.3 × 11	135
220	6.3 × 11	160	6.3 × 11	175	8 × 11.5	215	8 × 11.5	230
330	6.3 × 11	195	8 × 11.5	245	8 × 11.5	260	10 × 12.5	335
470	8 × 11.5	270	8 × 11.5	290	10 × 12.5	370	10 × 16	440
1000	10 × 12.5	460	10 × 16	550	10 × 20	640	12.5 × 20	770
2200	12.5 × 20	810	12.5 × 20	860	12.5 × 25	1,000	16 × 25	1,170
3300	12.5 × 20	960	12.5 × 25	1,100	16 × 25	1,300	16 × 31.5	1,460
4700	16 × 25	1,330	16 × 25	1,400	16 × 31.5	1,600	18 × 35.5	1,780

Note: I. Ripple Current: (mA/rms) 105°C, 120Hz

## CASE SIZE & PERMISSIBLE RIPPLE CURRENT OF STANDARD PRODUCTS

D x L: mm

CAP. (μF)	RATED VOLTAGE WV (SURGE VOLTAGE WV)							
	35 (44) SIZE		50 (63) SIZE		63 (79) SIZE		100 (125) SIZE	
		RIPPLE		RIPPLE		RIPPLE		RIPPLE
2.2			5 x 11	20			5 x 11	23
3.3			5 x 11	25			5 x 11	29
4.7	5 x 11	28	5 x 11	30	5 x 11	32	5 x 11	34
10	5 x 11	41	5 x 11	46	5 x 11	50	6.3 x 11	56
22	5 x 11	61	5 x 11	68	6.3 x 11	82	8 x 11.5	96
33	5 x 11	75	6.3 x 11	90	6.3 x 11	100	10 x 12.5	140
47	6.3 x 11	100	6.3 x 11	110	8 x 11.5	135	10 x 16	180
100	8 x 11.5	170	8 x 11.5	180	10 x 12.5	225	12.5 x 20	320
220	10 x 12.5	300	10 x 16	345	10 x 20	400	16 x 25	570
330	10 x 16	400	10 x 20	460	12.5 x 20	540	16 x 25	700
470	10 x 20	520	12.5 x 20	610	12.5 x 25	700	16 x 31.5	880
1000	12.5 x 25	920	16 x 25	1,080	16 x 31.5	1,210		
2200	16 x 31.5	1,340	18 x 35.5	1,530				
3300	18 x 35.5	1,650						
4700	18 x 40	1,900						

Note: I. Ripple Current: (mA/rms) 105°C, 120Hz



## CASE SIZE & PERMISSIBLE RIPPLE CURRENT OF STANDARD PRODUCTS

D x L: mm

CAP. (μF)	RATED VOLTAGE WV (SURGE VOLTAGE WV)					
	63 (79) SIZE	RIPPLE	80 (100) SIZE	RIPPLE	100 (125) SIZE	RIPPLE
0.10	5 x 11	1	5 x 11	1	5 x 11	1
0.15	5 x 11	4	5 x 11	4	5 x 11	4
0.22	5 x 11	4	5 x 11	4	5 x 11	4
0.33	5 x 11	6	5 x 11	6	5 x 11	6
0.47	5 x 11	7	5 x 11	7	5 x 11	7
0.56	5 x 11	7	5 x 11	7	5 x 11	7
0.68	5 x 11	9	5 x 11	9	5 x 11	9
1.0	4 x 7	12	5 x 11	18	5 x 11	18
	5 x 11	18				
1.5	5 x 11	24	5 x 11	24	5 x 11	24
2.2	5 x 11	30	5 x 11	30	6.3 x 11	30
3.3	5 x 11	36	6.3 x 11	36	8 x 11	36
4.7	6.3 x 11	45	6.3 x 11	45	8 x 11	60
6.8	6.3 x 11	55	8 x 11	60	10 x 12	67
10	8 x 11	82	10 x 12	90	10 x 15	94
15	10 x 12	103	10 x 15	112	10 x 19.5	117
22	10 x 15	148	10 x 15	165	10 x 19.5	187
33	10 x 15	210	10 x 19.5	217	13 x 20	225
47	10 x 19.5	240	10 x 19.5	276	13 x 25	285
68	10 x 19.5	328	13 x 20	361	13 x 25	375
100	13 x 25	420	13 x 25	447	16 x 25	456
150	13 x 25	648	16 x 25	663	16 x 32	707
220	16 x 32	930	16 x 32	970	16 x 36	1010
330	16 x 36	1088	16 x 36	1198	18 x 36	1377
470	18 x 36	1385	18 x 36	1509		
680	18 x 36	1870				
820	18 x 40	1950				

Note: I. Ripple Current: (mA/rms) 105°C, 120Hz

# SZ [ Ultra Low ESR ]

105°C Single-Ended Lead Aluminum Electrolytic Capacitors for High Frequency Applications

## Miniature Aluminum Electrolytic Capacitors

### ELECTRICAL CHARACTERISTICS

Operating Temperature Range : -40 ~ +105°C

Rated Voltage Range : 6.3 ~ 16V

Rated Capacitance Range : 470 ~ 3300μF

Capacitance Tolerance : -20 ~ +20% at 120Hz, 20°C

DC Leakage Current (μA) : I = 0.03 CV whichever is greater.  
(After Rated Voltage Applied for 2 Minutes)

Dissipation Factor

WV (V) :	6.3	10	16
D.F. (%) :	22	19	16

When nominal capacitance is over 1000μF, tan δ shall be added 0.02 to the listed value with increase of every 1000μF.

WV (V) :	Rated Voltage (V)	6.3	10	16
Impedance :	Z - 25°C / Z + 20°C	2	2	2
	Z - 40°C / Z + 20°C	3	3	3

Endurance: After the rated voltage has been applied at 105°C for 2000 hours, the capacitors shall meet the following requirements.

- (a) Capacitance Change : Within ±25% of Initial Value
- (b) Dissipation Factor : Not Exceeding 200% of Specified Value
- (c) Leakage Current : Not Exceeding the Specified Value

Shelf Life: After having been placed at 105°C without voltage applied for 1000 hours, the capacitors shall meet the same requirements as Endurance.

### DIAGRAM OF DIMENSIONS

Dø	F	dø
4.0	1.5	0.45
5.0	2.0	0.5
6.3	2.5	
8.0	3.5	0.6
10.0	5.0	
12.0		
13.0		
16.0	7.5	0.8
18.0		
22.0	10.0	

Rubber Stand-off

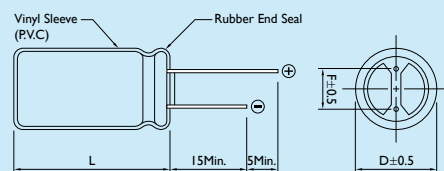

L ≤ 16 L + 1.5Max.  
L > 16 L + 2Max.  
Dø = 8 & 10 L + 2.5Max.  
Dø < 20 Dø + 0.5  
Dø ≥ 20 Dø + 1

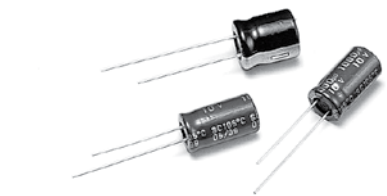

### DESCRIPTION

Used in switching regulator applications in computers, especially for high frequency.

Low impedance and ESR, high permissible ripple current at high frequency and higher operating temperature (-40°C to +105°C).

High Temperature Load Life at 105°C for 2000 Hours

#### MULTIPLIER FOR RIPPLE CURRENT

Frequency Coefficient

FREQUENCY (Hz)	120	1K	10K	100K
FACTOR	0.50	0.80	0.90	1.00

Temperature Coefficient

TEMPERATURE (°C)	65	85	105
FACTOR	2.10	1.70	1.00

Dimensions: mm

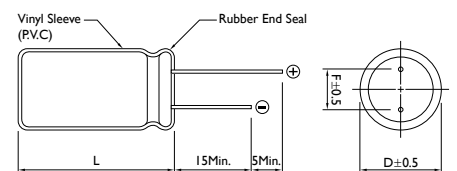

## CASE SIZE & PERMISSIBLE RIPPLE CURRENT OF STANDARD PRODUCTS

D x L: mm

CAP. (μF)	RATED VOLTAGE WV (SURGE VOLTAGE WV)								
	6.3 (8) SIZE			10 (13) SIZE			16 (20) SIZE		
	SIZE	RIPPLE	ESR	SIZE	RIPPLE	ESR	SIZE	RIPPLE	ESR
470							8 x 11	1036	43
680				8 x 11	1036	43	8 x 15	1355	34
							10 x 12	1400	31
820	8 x 11	1036	43						
1000				8 x 15	1355	34	8 x 20	1700	25
				10 x 12	1400	31	10 x 15	1818	23
1200	8 x 15	1355	34						
1500	8 x 20	1740	25	8 x 20	1700	25	10 x 19.5	2318	16
	10 x 12	1400	31	10 x 15	1818	23			
1800	10 x 15	1818	23	10 x 19.5	2318	16	10 x 25	2546	14
2200	10 x 19.5	2318	15	10 x 25	2545	14			
3300	10 x 25	2364	14						

Note: 1. Ripple Current: (mA/rms) 105°C, 100KHz  
 2. ESR: 100KHz / 20°C (mΩ Max.)

# SQ [ Adapter and Power Supply Applications Series ]

105°C 2000 Hours, Wide Temperature Range and Low Impedance

## Miniature Aluminum Electrolytic Capacitors

### ELECTRICAL CHARACTERISTICS

Operating Temperature Range : -40 ~ +105°C

Rated Voltage Range : 160V ~ 450DC

Rated Capacitance Range : 2.2 ~ 220μF

Capacitance Tolerance : -20 ~ +20% at 120Hz, 20°C

DC Leakage Current (μA) :  $I \leq 0.03CV + 10\mu A$  (After Rated Voltage Applied for 3 Minutes)

I = Leakage Current (μA), C = Nominal Capacitance (μF), V = Rated Voltage (V)

Dissipation Factor

WV (V) :	160	200	250	350	400	450
D.F. (%) :	15	15	15	24	24	24

WV (V) :	160	200	250	350	400	450
Impedance : Z - 25°C / Z + 20°C	3	3	3	3	3	3
Z - 40°C / Z + 20°C	6	6	6	6	6	6

Endurance : After the rated voltage has been applied at 105°C for 2000 hours. The capacitors shall meet the following requirements.

- (a) Capacitance Change : Within 20% of Initial Value
- (b) Dissipation Factor : Not Exceeding 200% of the Specified Value
- (c) Leakage Current : Not Exceeding the Specified Value

Shelf Life: After leaving capacitors under no load at 105°C for 1000 hours, the capacitors shall meet the same requirements as Endurance.

### DIAGRAM OF DIMENSIONS

#### Rubber Stand-off

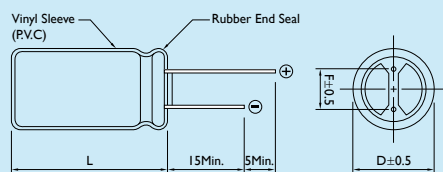

$L \leq 16 L + 1.5\text{Max.}$   
 $L > 16 L + 2\text{Max.}$   
 $D\phi = 8 \& 10 L + 2.5\text{Max.}$

$D\phi < 20 D\phi + 0.5$   
 $D\phi \geq 20 D\phi + 1$

Dφ	F	dφ
10.0	5.0	0.6
13.0		
16.0	7.5	0.8
18.0		

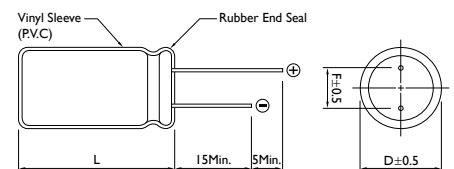

Dimensions: mm

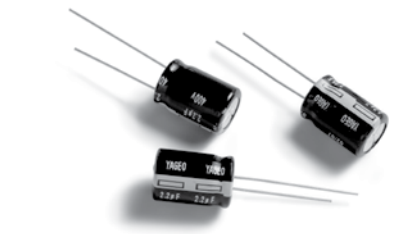

### DESCRIPTION

Recommended Applications: AV (TV, Video, Audio), Monitor / Computer, OA / HA / Communication, Converter / Inverter, Energy Saving Lamp, PFC Circuit, SMPS, Ballast, Adapter

### MULTIPLIER FOR RIPPLE CURRENT

Frequency Coefficient

FREQUENCY (Hz)	50	120	1K	10K	100K
< 33μF	0.80	1.00	1.36	1.54	1.80
≥ 34μF	0.85	1.00	1.28	1.35	1.40

## CASE SIZE & PERMISSIBLE RIPPLE CURRENT OF STANDARD PRODUCTS

D x L: mm

CAP. (μF)	RATED VOLTAGE WV (SURGE VOLTAGE WV)								
	160 (200)			200 (250)			250 (300)		
	SIZE	RIPPLE 120Hz	100KHz	SIZE	RRIPPLE 120Hz	100KHz	SIZE	RIPPLE 120Hz	100KHz
10							10 x 19.5	120	220
22	10 x 19.5	195	350	10 x 19.5	195	350	13 x 25	165	300
33	13 x 20	315	450	13 x 20	365	520	13 x 25	280	400
47	13 x 25	420	600	13 x 25	420	600	16 x 25	505	720
68	13 x 25	420	600	16 x 25	665	950	16 x 32	570	810
100	16 x 25	665	950	16 x 32	840	1200	18 x 36	735	1050
220	18 x 36	980	1400						

Note: I. Ripple Current: (mA/rms) 105°C, 120Hz & 100KHz

## CASE SIZE & PERMISSIBLE RIPPLE CURRENT OF STANDARD PRODUCTS

D x L: mm

CAP. (μF)	RATED VOLTAGE WV (SURGE VOLTAGE WV)								
	350 (400)			400 (450)			450 (500)		
	SIZE	RIPPLE 120Hz	100KHz	SIZE	RIPPLE 120Hz	100KHz	SIZE	RIPPLE 120Hz	100KHz
2.2	10 x 15	30	50	10 x 15	80	140	10 x 15	60	110
3.3	10 x 15	35	60	10 x 19.5	110	195	10 x 19.5	75	135
4.7	10 x 19.5	45	78	10 x 25	120	220	13 x 20	105	190
10	13 x 20	75	130	13 x 25	200	360	13 x 25	140	250
22	16 x 25	115	205	16 x 25	315	570	16 x 32	265	480
33	16 x 32	180	255	16 x 32	490	700	18 x 36	455	650
47	18 x 32	225	320	18 x 32	600	860			
82							18 x 36	520	720
100	18 x 45	370	530						
120							18 x 40	720	1000

Note: I. Ripple Current: (mA/rms) 105°C, 120Hz & 100KHz

# SC [ High Reliability and High Professional Application ]

105°C 2000 ~ 3000 Hours, 6.3-450V

## Miniature Aluminum Electrolytic Capacitors

### ELECTRICAL CHARACTERISTICS

Operating Temperature Range : -40 ~ +105°C / -25 ~ +105°C

Rated Voltage Range : 6.3 ~ 250V / 350 ~ 450V

Rated Capacitance Range : 4.7 ~ 15000μF

Capacitance Tolerance : -20 ~ +20% at 120Hz, 20°C

DC Leakage Current (μA) : I = 0.01CV or 3μA whichever is greater.  
(After Rated Voltage Applied for 2 Minutes)

Dissipation Factor

WV (V) :	6.3	10	16	25	35	50	63	100	160-250	350-450
D.F. (%) :	22	19	16	14	12	10	9	8	15	24

When nominal capacitance is over 1000μF, tan δ shall be added 0.02 to listed value with increase of every 1000μF.

WV (V) :		6.3	10	16	25	35	50	63	100	160-450
Impedance :	Z(120Hz) Z -25°C / Z +20°C	4	3	3	3	3	2	2	2	3
	Z(120Hz) Z -40°C / Z +20°C	8	6	4	4	4	4	4	4	6

The above specifications shall be satisfied when the capacitors are restored to 20°C after the rated voltage applied with rated ripple current for 2000-3000 hours at 105°C.

2,000 hours øD ≤ 10mm

3,000 hours øD ≥ 12.5mm

If Dimension is Down Size, Endurance will be Less 1000 hours than Standard

(a) Capacitance Change : Within ±20% of Initial Value

(b) Dissipation Factor: Not Exceeding 200% of Specified Value

**CASE SIZE** 5x11 ~ 10x12 10x15 higher

(c) Leakage Current: Not Exceeding the Specified Value

**LIFE** 2000 3000

Shelf Life : After having been placed at 105°C without voltage applied for 1000 hours, the capacitors shall meet the same requirements as Endurance.

### DIAGRAM OF DIMENSIONS

Dø	F	dø
4.0	1.5	0.45
5.0	2.0	0.5
6.3	2.5	
8.0	3.5	0.6
10.0	5.0	
12.0		
13.0		
16.0	7.5	0.8
18.0		
22.0	10.0	0.8 (1.0)

Rubber Stand-off

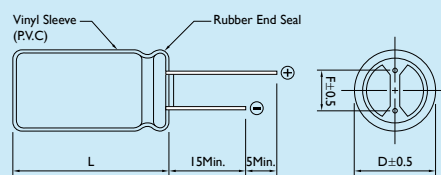

L ≤ 16 L + 1.5Max.  
L > 16 L + 2Max.  
Dø = 8 & 10 L + 2.5Max.

Dø < 20 Dø + 0.5  
Dø ≥ 20 Dø + 1

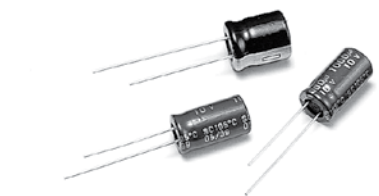

### DESCRIPTION

Applicable for switching regulator of computers, especially for high frequency

### MULTIPLIER FOR RIPPLE CURRENT

Frequency Coefficient

FREQUENCY (Hz)	50	120	300	1K	10K
~4.7μF	0.30	0.40	0.50	0.70	0.80
5.6~33μF	0.40	0.50	0.60	0.80	0.90
34~330μF	0.60	0.70	0.80	0.90	0.95
331~1000μF	0.65	0.90	0.90	0.98	1.00
1200μF Higher	0.85	0.90	0.95	0.98	1.00

### FEATURES

105°C 2,000~3,000 hours assured

Switching power supplies, Lighting, Monitors, General Industrial

RoHS Compliance

Dimensions: mm

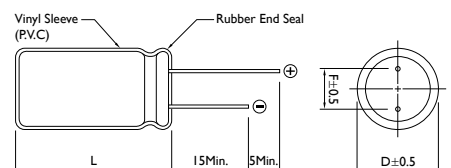

## CASE SIZE & PERMISSIBLE RIPPLE CURRENT OF STANDARD PRODUCTS

D x L: mm

CAP. (μF)	RATED VOLTAGE WV (SURGE VOLTAGE WV)											
	6.3 (8)			10 (13)			16 (20)			25 (32)		
	SIZE	RIPPLE	ESR	SIZE	RIPPLE	ESR	SIZE	RIPPLE	ESR	SIZE	RIPPLE	ESR
10										*4 x 7	40	2.000
										5 x 11	50	0.550
47										5 x 11	150	0.450
56							5 x 11	100	0.630	5 x 11	150	0.420
68							5 x 11	150	0.420	6.3 x 11	200	0.370
100				5 x 11	150	0.420	5 x 11	200	0.370	6.3 x 11	250	0.220
120				5 x 11	200	0.370	6.3 x 11	250	0.320	8 x 11	300	0.200
150	5 x 11	200	0.420	6.3 x 11	250	0.320	6.3 x 11	300	0.220	8 x 11	550	0.140
220	6.3 x 11	250	0.320	6.3 x 11	300	0.220	8 x 11	550	0.140	*8 x 11	620	0.120
										8 x 15	750	0.100
270	*6.3 x 11	300	0.220									
330	*6.3 x 11	320	0.230	8 x 11	550	0.140	*8 x 11	620	0.120	*8 x 15	660	0.100
	8 x 11	400	0.180				8 x 15	750	0.100	8 x 20	800	0.069
							10 x 12	688	0.080	10 x 15	900	0.086
470	*6.3 x 11	440	0.180	*8 x 11	620	0.120	*8 x 15	730	0.093	*8 x 20	1000	0.067
	8 x 11	550	0.140	8 x 15	750	0.100	10 x 12	800	0.085	*10 x 12	900	0.086
										10 x 15	1050	0.064
680	*8 x 11	580	0.120	*8 x 11	640	0.110	10 x 15	1050	0.064	10 x 19.5	1100	0.039
	8 x 15	700	0.100	10 x 12	800	0.085						
820	8 x 20	750	0.085	10 x 15	1050	0.064	10 x 19.5	1100	0.044	10 x 19.5	1250	0.039
1000	*8 x 11	580	0.150	8 x 20	1080	0.065	*10 x 15	1140	0.043	*10 x 19.5	1160	0.047
	*8 x 15	670	0.085	10 x 12	930	0.075	10 x 19.5	1250	0.039	*10 x 25	1310	0.042
	8 x 20	800	0.069	10 x 15	990	0.085				13 x 20	1450	0.038
	10 x 12	690	0.080	10 x 19.5	1100	0.050						
1200	10 x 15	1000	0.064	10 x 19.5	1250	0.044	*10 x 25	1310	0.042	13 x 25	1600	0.029
							13 x 20	1450	0.038			
1500	*8 x 15	980	0.085	10 x 19.5	1450	0.039	*10 x 19.5	1200	0.045	*12 x 30	1750	0.032
	*8 x 20	1070	0.051				13 x 20	1600	0.034	16 x 25	2000	0.028
	*10 x 15	1070	0.055									
	10 x 19.5	1250	0.044									

Note: 1. Ripple Current: (mA/rms) 105°C, 100KHz  
 2. ESR: 100KHz / 20°C (Ω Max.)  
 3. \* Down Size: 1000 Hours less than standard

## CASE SIZE & PERMISSIBLE RIPPLE CURRENT OF STANDARD PRODUCTS

D x L: mm

CAP. (μF)	RATED VOLTAGE WV (SURGE VOLTAGE WV)											
	6.3 (8)			10 (13)			16 (20)			25 (32)		
	SIZE	RIPPLE	ESR	SIZE	RIPPLE	ESR	SIZE	RIPPLE	ESR	SIZE	RIPPLE	ESR
2200	*10 × 19.5	1220	0.051	*10 × 19.5	1330	0.047	*10 × 30	1780	0.032	*13 × 30	1810	0.029
	*10 × 25	1310	0.048	*10 × 25	1450	0.039	*13 × 20	1720	0.033	*16 × 25	1660	0.032
	13 × 20	1450	0.043	13 × 20	1600	0.038	13 × 25	2000	0.028	16 × 32	2200	0.024
3300	*10 × 25	1400	0.043	*10 × 30	1740	0.032	*13 × 40	2200	0.026	*16 × 36	2540	0.019
	13 × 25	1700	0.035	13 × 25	2000	0.028	16 × 25	2200	0.024	18 × 36	2550	0.019
3900	13 × 25	1750	0.032									
4700	*12 × 30	1570	0.033	*13 × 25	1860	0.028	16 × 36	2550	0.019	18 × 36	2800	0.019
	*13 × 25	1520	0.032	16 × 25	2200	0.024						
	16 × 25	1800	0.028									
6800	16 × 32	2000	0.024	16 × 36	2550	0.019	18 × 36	2800	0.019	18 × 36	2800	0.019
8200	16 × 32	2350	0.019	18 × 36	2800	0.019						
10000	16 × 36	2550	0.019									
15000	18 × 36	3000	0.019									

- Note: 1. Ripple Current: (mA/rms) 105°C, 100KHz  
 2. ESR: 100KHz / 20°C (Ω Max.)  
 3. \* Down Size: 1000 Hours less than standard



## CASE SIZE & PERMISSIBLE RIPPLE CURRENT OF STANDARD PRODUCTS

D x L: mm

CAP. (μF)	RATED VOLTAGE WV (SURGE VOLTAGE WV)											
	35 (44)			50 (63)			63 (79)			100 (125)		
	SIZE	RIPPLE	ESR	SIZE	RIPPLE	ESR	SIZE	RIPPLE	ESR	SIZE	RIPPLE	ESR
4.7	5 x 11	115	1.200	5 x 11	115	2.000	5 x 11	115	2.200	5 x 11	120	2.000
6.8	5 x 11	120	1.000	5 x 11	120	1.850	5 x 11	120	2.000	5 x 11	140	1.850
10	5 x 11	140	0.900	5 x 11	140	1.700	5 x 11	140	1.850	6.3 x 11	200	1.500
15	5 x 11	170	0.690	5 x 11	180	1.200	5 x 11	200	1.700	6.3 x 11	250	1.200
22	5 x 11	190	0.420	5 x 11	200	0.700	6.3 x 11	250	1.200	8 x 11	300	0.790
33	5 x 11	200	0.420	6.3 x 11	250	0.600	6.3 x 11	300	0.900	8 x 15	450	0.590
47	6.3 x 11	250	0.370	6.3 x 11	300	0.520	8 x 11	450	0.700	10 x 15	550	0.350
68	6.3 x 11	300	0.220	8 x 11	450	0.350	8 x 11	550	0.520	10 x 19.5	650	0.240
100	*6.3 x 11	360	0.180	*8 x 11	480	0.290	8 x 20	650	0.350	13 x 20	800	0.180
	8 x 11	450	0.140	8 x 15	550	0.250						
120	8 x 11	550	0.130	8 x 20	650	0.210	10 x 15	800	0.300	13 x 25	1050	0.150
150	8 x 15	650	0.100	10 x 12	800	0.160	10 x 15	1050	0.200	13 x 25	1300	0.110
220	*8 x 15	730	0.100	*10 x 15	1050	0.100	10 x 19.5	1300	0.150	16 x 25	1400	0.071
	10 x 12	800	0.069	10 x 25	1050	0.068						
330	*10 x 15	900	0.052	10 x 19.5	1300	0.072	13 x 20	1400	0.100	16 x 32	1550	0.049
	10 x 19.5	1050	0.044									
470	10 x 19.5	1300	0.039	*10 x 19.5	1390	0.075	13 x 25	1550	0.064	18 x 36	1770	0.038
				13 x 20	1400	0.060						
680	13 x 20	1400	0.038	13 x 25	1550	0.050	16 x 25	1700	0.052			
820	13 x 20	1550	0.034	16 x 25	1700	0.040	16 x 32	1900	0.048			
1000	13 x 25	1700	0.029	16 x 25	1900	0.039	16 x 32	2100	0.042			
1200	16 x 25	1900	0.028	16 x 32	2100	0.025	16 x 36	2550	0.036			
1500	16 x 25	2100	0.024	16 x 36	2550	0.025	18 x 36	2800	0.033			
2200	*16 x 32	2300	0.021	18 x 40	2800	0.025						
	16 x 36	2550	0.019									
3300	18 x 36	2880	0.019									

Note: 1. Ripple Current: (mA/rms) 105°C, 100KHz  
 2. ESR: 100KHz / 20°C (Ω Max.)  
 3. \* Down Size: 1000 Hours less than standard

## CASE SIZE & PERMISSIBLE RIPPLE CURRENT OF STANDARD PRODUCTS

D x L: mm

CAP. (μF)	RATED VOLTAGE WV (SURGE VOLTAGE WV)								
	160 (200)	RIPPLE	ESR 120KHz	200 (250)	RRIPPLE	ESR	250 (300)	RIPPLE	ESR
10	10 x 12.5	95	16	10 x 16	95	15.9	10 x 16	105	16
22	10 x 16	145	7.2	10 x 19.5	145	7.2	13 x 20	180	7.2
33	10 x 20	190	4.8	13 x 20	190	4.8	13 x 25	250	4.8
47	13 x 25	280	3.4	13 x 25	280	3.4	16 x 25	300	3.4
68	13 x 25	380		16 x 25			16 x 32		
100	13 x 25	450	1.6	16 x 25.5	410	1.6	16 x 32	410	1.6
				18 x 20					
220	16 x 36	630	0.7						

Note: I. Ripple Current: (mA/rms) 105°C, 120Hz & 100KHz

## CASE SIZE & PERMISSIBLE RIPPLE CURRENT OF STANDARD PRODUCTS

D x L: mm

CAP. (μF)	RATED VOLTAGE WV (SURGE VOLTAGE WV)								
	350 (400)	RIPPLE	ESR	400 (450)	RIPPLE	ESR	450 (500)	RIPPLE	ESR
2.2			50	10 x 12.5	40	90	10 x 16	45	120
3.3	8 x 11	50	60	10 x 16	50	60	10 x 19.5	75	80
4.7	10 x 16	65	42	10 x 20	70	42	13 x 20	105	56
10	10 x 20	120	20	13 x 20	120	20	13 x 25	140	26
22	12.5 x 20	180	9	13 x 25	200	9	16 x 25.5	220	12
33	12.5 x 25.5	210		18 x 20	245	6	18 x 32	280	8
47	18 x 32	350	4.2	16 x 32	380	4.2	16 x 31.5	420	5.6
82							18 x 36	650	3.2
100	18 x 32	650	2				18 x 36	760	2.7
							16 x 45	760	2.7
120							18 x 40	720	2.2
150							20 x 40	920	1.8
							18 x 46	920	1.8

Note: I. Ripple Current: (mA/rms) 105°C, 120Hz & 100KHz

# Miniature Aluminum Electrolytic Capacitors

# SJ [ Low Impedance and High Ripple Series ]

105°C 1000 ~ 5000 Hours, Low Impedance and High Ripple Current

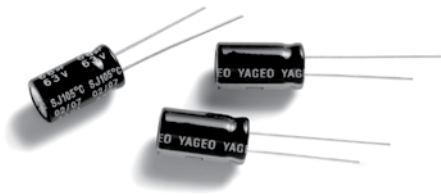

## DESCRIPTION

AV (TV, Video, Audio), Monitor / Computer, OA / HA / Communication, Converter / Inverter, Adapter, SMPS

### MULTIPLIER FOR RIPPLE CURRENT

Frequency Coefficient

FREQUENCY (Hz)	50	120	1K	10K	100K
5.6~390μF	0.60	0.70	0.85	0.95	1.00
470~1000μF	0.65	0.75	0.90	0.98	1.00
1200~6800μF	0.75	0.80	0.95	1.00	1.00

### ENDURANCE

CASE	LIFETIME (HOURS)	
L = 7	1000	
L ≥ 11	Dø ≤ 6.3	2000
	Dø = 8	3000
	Dø = 10	4000
	Dø ≥ 12.5	5000

## DIAGRAM OF DIMENSIONS

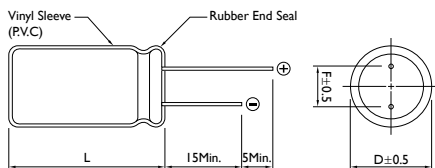

### Rubber Stand-off

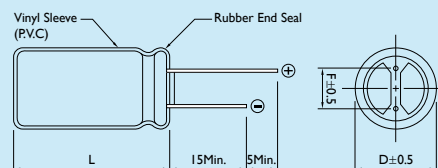

L ≤ 16 L + 1.5Max.  
L > 16 L + 2Max.  
Dø = 8 & 10 L + 2.5Max.

Dø < 20 Dø + 0.5  
Dø ≥ 20 Dø + 1

Dø	F	dø
4.0	1.5	0.45
5.0	2.0	0.5
6.3	2.5	
8.0	3.5	0.6
10.0	5.0	
13.0		
16.0	7.5	0.8
18.0		

Dimensions: mm

## ELECTRICAL CHARACTERISTICS

Operating Temperature Range : -40 ~ +105°C

Rated Voltage Range : 6.3 ~ 100V

Rated Capacitance Range : 5.6 ~ 6800μF

Capacitance Tolerance : -20 ~ +20% at 120KHz

DC Leakage Current (μA) : I = 0.01 CV (μA) or 3μA whichever is greater.

Dissipation Factor

WV (V) :	6.3	10	16	25	35	50	63	100	
D.F. (%) :	22	19	16	14	12	10	9	8	--

WV (V) :				6.3	10	16	25	35	50	63	100
Impedance : Z - 25°C / Z + 20°C				2	2	2	2	2	2	2	2
Z - 40°C / Z + 20°C				3	3	3	3	3	3	3	3

Endurance: After the rated voltage and maximum ripple current have been applied at 105°C for 1000 ~ 5000 hours, the capacitors shall meet the following requirements.

- (a) Capacitance Change: Within ±25% of the Initial Value
- (b) Dissipation Factor: Not Exceeding 200% of the Specified Value
- (c) Leakage Current: Not Exceeding the Specified Value

Shelf Life: After having been placed at 105°C without voltage applied for 1000 hours. (500 hours for L=7)  
The capacitors shall meet the same requirements as Endurance.

## CASE SIZE & PERMISSIBLE RIPPLE CURRENT OF STANDARD PRODUCTS

D x L: mm

CAP. (μF)	RATED VOLTAGE WV (SURGE VOLTAGE WV)														
	6.3 (8)			10 (13)			16 (20)			25 (32)			35 (44)		
	SIZE	RIPPLE	ESR	SIZE	RIPPLE	ESR	SIZE	RIPPLE	ESR	SIZE	RIPPLE	ESR	SIZE	RIPPLE	ESR
10													4 x 7	130	0.96
15										4 x 7	130	0.94	5 x 7	190	0.57
18							4 x 7	130	0.92	5 x 7	170	0.69	5 x 7	210	0.47
27				4 x 7	130	0.89	5 x 7	190	0.61	5 x 7	210	0.46	5 x 11	230	0.37
33				5 x 7	160	0.75	5 x 7	210	0.45	5 x 11	220	0.42	5 x 11	250	0.30
39	4 x 7	130	0.85	5 x 7	175	0.64	5 x 11	220	0.43	5 x 11	230	0.36	6.3 x 7	300	0.25
47	5 x 7	175	0.70	5 x 7	190	0.53	5 x 11	230	0.36	5 x 11	250	0.30	6.3 x 11	380	0.15
													8 x 7	350	0.19
56	5 x 7	190	0.56	5 x 7	210	0.44	5 x 11	250	0.30	6.3 x 7	300	0.24	6.3 x 11	410	0.13
													8 x 7	380	0.16
68	5 x 7	210	0.43	5 x 11	210	0.44	6.3 x 7	300	0.24	6.3 x 11	340	0.19	8 x 11	510	0.12
										8 x 7	310	0.22			
100	5 x 11	200	0.43	5 x 11	250	0.30	6.3 x 11	370	0.16	6.3 x 11	410	0.13	8 x 11	620	0.105
	6.3 x 7	240	0.35				8 x 7	350	0.18	8 x 7	380	0.15			
120	5 x 11	220	0.38	6.3 x 7	300	0.23	6.3 x 11	410	0.13	8 x 11	560	0.12	8 x 11	680	0.088
	6.3 x 7	270	0.29				8 x 7	380	0.15						
150	5 x 11	250	0.30	8 x 7	350	0.18	8 x 11	510	0.12	8 x 11	630	0.105	8 x 11	760	0.072
	6.3 x 7	300	0.23												
180	8 x 7	340	0.18	8 x 7	380	0.15	8 x 11	560	0.11	8 x 11	690	0.088	8 x 15	910	0.068
													10 x 12	930	0.065
220	8 x 7	380	0.15	6.3 x 11	410	0.13	8 x 11	620	0.10	8 x 11	760	0.072	10 x 12	1030	0.053
270	6.3 x 11	370	0.16	8 x 11	580	0.12	8 x 11	690	0.088	8 x 15	900	0.068	8 x 20	1250	0.041
										10 x 12	930	0.065			
330	6.3 x 11	410	0.13	8 x 11	640	0.10	8 x 11	760	0.072	10 x 12	1030	0.053	10 x 15	1430	0.038
470	8 x 11	680	0.086	8 x 11	760	0.072	8 x 15	1000	0.056	8 x 20	1250	0.041	10 x 19.5	1820	0.026
							10 x 12	1030	0.053	10 x 15	1430	0.038			
560	8 x 11	760	0.072	8 x 15	910	0.068	8 x 20	1140	0.049	10 x 19.5	1650	0.032	10 x 25	2150	0.023
				10 x 12	940	0.064	10 x 15	1300	0.046						
680	8 x 15	900	0.062	10 x 12	1030	0.053	8 x 20	1250	0.041	10 x 19.5	1820	0.026	13 x 20	2360	0.023
							10 x 15	1430	0.038						

Note: 1. Ripple Current: (mA/rms) 105°C, 100KHz

2. ESR: 100KHz / 20°C (Ω Max.)

## CASE SIZE & PERMISSIBLE RIPPLE CURRENT OF STANDARD PRODUCTS

D x L: mm

CAP. (μF)	RATED VOLTAGE WV (SURGE VOLTAGE WV)														
	6.3 (8)			10 (13)			16 (20)			25 (32)			35 (44)		
	SIZE	RIPPLE	ESR	SIZE	RIPPLE	ESR	SIZE	RIPPLE	ESR	SIZE	RIPPLE	ESR	SIZE	RIPPLE	ESR
820	8 x 15	1000	0.056	8 x 20	1130	0.05	10 x 19.5	1650	0.032	10 x 25	2150	0.023	13 x 25	2510	0.02
				10 x 15	1300	0.046									
1000	10 x 12	1030	0.053	8 x 20	1250	0.041	10 x 19.5	1820	0.026	13 x 20	2360	0.021	13 x 25	2770	0.018
				10 x 15	1430	0.038									
1200	8 x 20	1250	0.041	10 x 19.5	1820	0.026	10 x 25	2150	0.023	13 x 25	2510	0.02	13 x 30	3290	0.016
	10 x 15	1430	0.038												
1500	10 x 19.5	1820	0.026	10 x 25	2150	0.023	13 x 20	2360	0.021	13 x 25	2770	0.018	13 x 35	3400	0.015
1800	10 x 25	1940	0.025	13 x 20	2230	0.022	13 x 25	2510	0.02	13 x 30	3290	0.016	16 x 25	3460	0.016
2200	10 x 25	2150	0.023	13 x 20	2360	0.021	13 x 25	2770	0.018	13 x 35	3400	0.015			
2700	13 x 20	2230	0.022	13 x 25	2510	0.02	13 x 30	3290	0.016	16 x 25	3460	0.016			
													16 x 20	3140	0.018
3300	13 x 20	2360	0.021	13 x 25	2770	0.018	13 x 35	3400	0.015						
3900	13 x 25	2770	0.018	13 x 30	3290	0.016	16 x 25	3460	0.016						
										16 x 20	3140	0.018			
4700	13 x 30	3290	0.016	13 x 35	3400	0.015									
5600	13 x 35	3400	0.015	16 x 25	3460	0.016									
	16 x 20	3140	0.018												
6800	16 x 25	3460	0.016												

Note: 1. Ripple Current: (mA/rms) 105°C, 100KHz

2. ESR: 100KHz / 20°C (Ω Max.)

## CASE SIZE & PERMISSIBLE RIPPLE CURRENT OF STANDARD PRODUCTS

D × L: mm

CAP. (μF)	RATED VOLTAGE WV (SURGE VOLTAGE WV)								
	50 (63) SIZE			63 (79) SIZE			100 (125) SIZE		
	SIZE	RIPPLE	ESR	SIZE	RIPPLE	ESR	SIZE	RIPPLE	ESR
5.6	4 × 7	130	1.00						
6.8	5 × 7	170	0.74				5 × 11	125	1.40
10	5 × 7	210	0.50				6.3 × 11	170	0.95
15	6.3 × 7	220	0.38	5 × 11	136	1.190	6.3 × 11	210	0.57
	5 × 11	215	0.48						
22	6.3 × 7	300	0.26	6.3 × 11	176	0.880	8 × 11	330	0.44
	5 × 11	240	0.34						
27	8 × 7	340	0.21	6.3 × 11	192	0.580	8 × 11	360	0.36
33	8 × 7	380	0.17	6.3 × 11	216	0.470	8 × 15	375	0.30
39	6.3 × 11	330	0.16	8 × 11	308	0.420	8 × 15	450	0.25
47	6.3 × 11	360	0.15	8 × 11	336	0.350	10 × 12	450	0.24
56	6.3 × 11	390	0.14	8 × 11	400	0.350	8 × 20	570	0.19
68	8 × 11	600	0.11	8 × 15	488	0.260	10 × 15	580	0.18
				10 × 12	500	0.240			
82	8 × 11	660	0.09	8 × 15	536	0.220	10 × 19.5	750	0.13
				10 × 12	552	0.200	13 × 16	740	0.13
100	8 × 11	730	0.074	10 × 15	640	0.160	10 × 25	880	0.12
120	8 × 15	950	0.065	8 × 20	656	0.160	13 × 20	1050	0.094
				10 × 15	760	0.150			
150	10 × 12	980	0.061	10 × 19.5	808	0.130	13 × 25	1100	0.085
				13 × 16	832	0.130			
180	8 × 20	1190	0.046	10 × 19.5	880	0.110	13 × 25	1200	0.071
				13 × 16	912	0.110			
220	10 × 15	1370	0.042	10 × 25	1040	0.099	13 × 30	1410	0.063
							16 × 20	1300	0.071
270	10 × 19.5	1580	0.03	13 × 20	1200	0.081	13 × 35	1560	0.052
							16 × 25	1600	0.053
							18 × 20	1470	0.069
330	10 × 25	1870	0.028	13 × 25	1480	0.058	13 × 40	1700	0.046
390	13 × 20	1870	0.028	13 × 30	1640	0.063	16 × 32	1750	0.041
				16 × 20	1448	0.073	18 × 25	1620	0.049

Note: 1. Ripple Current: (mA/rms) 105°C, 100KHz  
 2. ESR: 100KHz / 20°C (Ω Max.)

## CASE SIZE & PERMISSIBLE RIPPLE CURRENT OF STANDARD PRODUCTS

D x L: mm

CAP. (μF)	RATED VOLTAGE WV (SURGE VOLTAGE WV)								
	50 (63) SIZE			63 (79) SIZE			100 (125) SIZE		
	SIZE	RIPPLE	ESR	SIZE	RIPPLE	ESR	SIZE	RIPPLE	ESR
470	13 x 20	2050	0.027	13 x 30	1800	0.061	16 x 36	1890	0.033
				16 x 20	1592	0.061	18 x 32	1780	0.039
560	13 x 25	2410	0.023	13 x 25	1960	0.047	16 x 40	2080	0.03
				16 x 25	2040	0.043	18 x 36	2060	0.031
680	13 x 30	2860	0.021	13 x 40	2224	0.039	18 x 40	2570	0.028
				18 x 20	1960	0.052			
820	13 x 35	2960	0.019	16 x 32	2248	0.035			
	16 x 20	2730	0.023	18 x 25	2224	0.042			
1000	16 x 32	3350	0.021	16 x 36	2227	0.028			
				18 x 32	2616	0.034			
1200				16 x 40	2672	0.026			
				18 x 36	2648	0.027			
1500				18 x 40	2736	0.024			

Note: 1. Ripple Current: (mA/rms) 105°C, 100KHz

2. ESR: 100KHz / 20°C (Ω Max.)

# SX [ Low Impedance and Low ESR ]

105°C 2000 ~ 5000 Hours, 6.3-100V

## Miniature Aluminum Electrolytic Capacitors

### ELECTRICAL CHARACTERISTICS

Operating Temperature : -40° ~ +105°C Working Voltage : 6.3 ~ 100V

Rate Capacitance Range : 1 ~ 15000µF Capacitance Tolerance : -20 ~ +20%

dC Leakage Current (µA) : i = 0.01 CV or 3(µA) Whichever is greater.

( Measurements shall be Made After a 2 Minute Charge at Rated Working Voltage )

dissipation Factor : at 120 Hz, 25°C

WV(V) :	6.3	10	16	25	35	50	63	80	100
D.F.(%) :	19	16	14	12	10	8	8	7	7

For capacitor whose capacitance exceeds 1000µF. The value of d.F.(%) is increased by 2% for every addition of 1000µF.

Temperature Characteristics : at 120 Hz

WV(V) :	6.3	10	16	25	35	50	63	100
impedance:	Z - 40°C / Z + 20°C	10	6	5	4	4	4	4

Load Life : At 105°C Assured with Full Rated Maximum Ripple Current Applied

Case dia     $\phi d \leq 8$      $\phi D = 10$      $\phi D \geq 12$

Load Life    2000    3000    5000

- (a) Capacitance Change : Within 20% of initial Value
- (b) dissipation Factor : not exceed 200% of initial Requirement
- (c) Leakage Current : not exceed the initial Requirement

Shelf Life : 1000 Hours, no Voltage Applied, at 105°C (a) Capacitance Change : Within 20% of initial Value

- (b) dissipation Factor : not exceed 200 % of initial Requirement
- (c) Leakage Current : not exceed 200% of initial Requirement



### DIAGRAM OF DIMENSIONS

Dimensions: mm

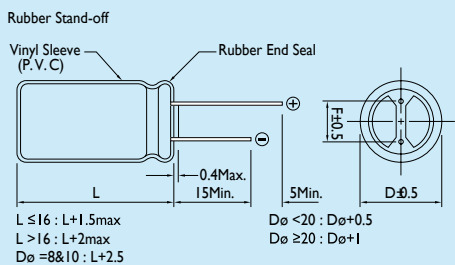

Dø	F	dø
4.0	1.5	0.45
5.0	2.0	0.5
6.0	2.5	
8.0	3.5	
10.0	5.0	0.6
12.0		
13.0		
16.0	7.5	0.8
18.0		
22.0	10.0	0.8

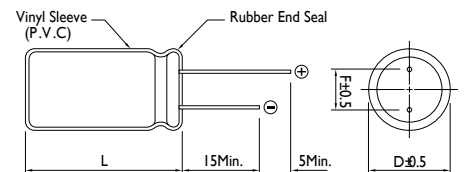

### Multiplier for Ripple Current Frequency coefficient

Frequency(Hz)	50	120	300	1K	10K	100K
~4.4µF	0.30	0.40	0.50	0.70	0.80	1.00
5.6~33µF	0.40	0.50	0.60	0.80	0.90	1.00
34~330µF	0.60	0.70	0.80	0.90	0.95	1.00
331~1000µF	0.65	0.90	0.90	0.98	1.00	1.00
1200µF higher	0.85	0.90	0.95	0.98	1.00	1.00

### Temperature coefficient

Temperature(°C)	65	85	105
Factor	1.80	1.50	1.00



### DESCRIPTION

Used in switching regulator applications in computers, especially for high frequency.

Low impedance and e.S.R., high permissible ripple current at high frequency and higher operation temperature (-40°C to +105°C).

High Temperature Load Life at 105°C for 2000 ~ 5000 Hours



## CASE SIZE OF STANDARD PRODUCTS $D \geq \varnothing 6\text{mm}$ with Safety Vent at Can Bottom

CAP. ( $\mu\text{F}$ )	RATED VOLTAGE								
	SIZE	6.3 Ripple	ESR	SIZE	10 Ripple	ESR	SIZE	16 Ripple	ESR
4.7									
6.8									
10				5 x 11	20	5.900			
22				5 x 11	44	5.400	5 x 11	42	1.180
33	5 x 11	131	0.217	5 x 11	66	3.300	5 x 11	53	3.300
47	5 x 11	139	0.203	5 x 11	94	2.200	5 x 11	79	2.100
56							5 x 11	210	0.580
68	5 x 11	150	0.182	5 x 11	136	1.300	5 x 11	210	0.580
							6.3 x 11	163	0.920
82				5 x 11	210	0.58	5 x 11	210	0.580
100	5 x 11	210	0.58	5 x 11	210	0.58	6.3 x 11	340	0.220
				6.3 x 11	200	0.10	8 x 11	241	0.890
120	5 x 11	210	0.58	5 x 11	210	0.58	6.3 x 11	340	0.220
				6.3 x 11	240	0.91	8 x 11	290	0.580
150	5 x 11	210	0.58	6.3 x 11	265	0.700	6.3 x 11	340	0.470
	6.3 x 11	210	0.58				8 x 11	380	0.470
180	6.3 x 11	340	0.22	6.3 x 11	340	0.22	8 x 11	640	0.130
220	8 x 11	285	0.61	6.3 x 11	340	0.22	8 x 11	410	0.330
	6.3 x 11	340	0.22	8 x 11	370	0.480			
270	6.3 x 11	340	0.22	8 x 11	640	0.13	8 x 11	640	0.130
330	8 x 11	410	0.40	8 x 11	470	0.330	10 x 12	600	0.230
	6.3 x 11	340	0.22				8 x 11	600	0.230
390	8 x 11	640	0.13				10 x 12	640	0.130
470	10 x 12	550	0.28	8 x 11	480	0.300	8 x 20	710	0.180
	6.3 x 11	540	0.22	10 x 12	590	0.240	8 x 15	750	0.180
	8 x 11	640	0.13				10 x 15	750	0.180
							10 x 12	750	0.180
560	8 x 11	640	0.13	8 x 15	790	0.18	8 x 15	840	0.06
							10 x 15	1050	0.14
680	10 x 15	735	0.220	8 x 20	790	0.180	10 x 19	1050	0.140
	8 x 11	640	0.13	10 x 12	750	0.18	8 x 20	1050	0.140
	8 x 15	840	0.087	10 x 15	790	0.18	10 x 15	1050	0.140
820	8 x 11	640	0.13	10 x 15	990	0.14	10 x 12	865	0.140
	10 x 15	795	0.190	10 x 19.5	990	0.140	10 x 15	1050	0.140
	8 x 15	840	0.089						
	10 x 12	865	0.08						
1000	10 x 19.5	950	0.170	8 x 20	1060	0.12	10 x 19	990	0.042
	10 x 12	865	0.08	10 x 15	1060	0.12	10 x 30	1400	0.091
				10 x 19.5	1060	0.12	10 x 25	990	0.042
1200	10 x 19.5	1000	0.136	10 x 25	1290	0.120	10 x 25	1450	0.086
	8 x 20	1050	0.069				12 x 25	1450	0.086
	10 x 15	1210	0.06						
1500	10 x 12	865	0.08	10 x 30	1450	0.093	12 x 25	1650	0.072
	10 x 19.5	1000	0.046	10 x 25	1450	0.093	10 x 30	1650	0.072
	8 x 20	1050	0.069				13 x 25	1790	0.055
	10 x 25	1200	0.120						
1800	10 x 25	1650	0.042	13 x 20	1900	0.046	13 x 25	1924	0.056
2200	10 x 30	1450	0.095	12 x 30	1900	0.073	12 x 30	2000	0.063
	10 x 25	1650	0.042	10 x 30	1900	0.073	16 x 20	2210	0.030
				13 x 20	1900	0.073	13 x 25	2124	0.030
2700	10 x 30	1910	0.031	13 x 25	2020	0.051	13 x 30	2524	0.035
	13 x 20	1900	0.035				16 x 20	2210	0.035
3300	12 x 35	1700	0.081	10 x 30	1690	0.077	13 x 40	2400	0.055
	10 x 25	1650	0.042	13 x 30	2110	0.052	18 x 20	2400	0.045
	13 x 20	1700	0.035	12 x 35	2110	0.052	12 x 35	2400	0.045
				16 x 20	2210	0.035	12 x 40	2400	0.045
3900	13 x 25	2124	0.03	16 x 20	2210	0.035	16 x 25	2552	0.028
							18 x 20	2495	0.034
4700	12 x 35	2110	0.063	13 x 40	2300	0.057	16 x 36	2650	0.046
	12 x 30	2110	0.053	12 x 40	2450	0.054	16 x 32	3029	0.220
				16 x 32	2450	0.054	18 x 25	2771	0.024
				16 x 25	2450	0.054			
5600	13 x 35	2743	0.022	16 x 25	2495	0.034	18 x 32	3600	0.020
	16 x 20	2210	0.035						
6800				18 x 20	2495	0.034			
	16 x 32	2350	0.055	16 x 36	2680	0.046	18 x 36	2900	0.040
	12 x 35	2743	0.022	16 x 32	2680	0.046	16 x 40	2900	0.040
	16 x 25	2552	0.028	18 x 25	2680	0.046			
	18 x 20	2495	0.034						
8200	16 x 36	2550	0.047	16 x 40	2850	0.038	18 x 40	3050	0.036
	16 x 32	3029	0.022	16 x 36	2850	0.038	18 x 36	3050	0.036
				18 x 32	2850	0.038			
10000	16 x 40	2750	0.039	18 x 36	3050	0.037	18 x 40	3781	0.015
	16 x 36	2750	0.039	16 x 40	3050	0.037			
	18 x 25	2771	0.024						
15000	18 x 40	2950	0.037						
	18 x 36	2950	0.037						
12000	16 x 40	3886	0.017	18 x 40	3781	0.020			
	18 x 32	3600	0.020						
18000	18 x 40	3781	0.02						

Note : \* 1. D x L : mm

\* 2. Ripple Current : ( mA r.m.s 105°C / 100KHz )

\* 3. ESR (  $\Omega$  Max20°C / 100KHz )

**CASE SIZE OF STANDARD PRODUCTS** D≥ ø 6mm with Safety Vent at Can Bottom

CAP. (µF)	RATED VOLTAGE								
	25			35			50		
	SIZE	Ripple	ESR	SIZE	Ripple	ESR	SIZE	Ripple	ESR
1							5 x 11	180	2.4
2.2							5 x 11	180	1.3
3.3							5 x 11	180	1.3
15							5 x 11	180	1.3
18							5 x 11	180	0.7
4.7							5 x 11	180	1.3
6.8				4 x 7	20	0.770	5 x 11	180	1.3
10				5 x 11	42	0.310	5 x 11	180	1.3
12							5 x 11	180	1.3
22	5 x 11	66	3.300	5 x 11	101	0.580	6.3 x 11	129	0.900
27				5 x 11	210	0.580	5 x 11	180	0.7
33	5 x 11	99	1.300	6.3 x 11	151	0.870	8 x 11	194	0.720
39	5 x 11	210	0.580	5 x 11	210	0.580	6.3 x 11	295	0.3
47	5 x 11	210	0.580	8 x 11	216	0.870	8 x 11	276	0.660
56	5 x 11	210	0.580	6.3 x 11	340	0.220	6.3 x 11	222	0.82
68	8 x 11	204	0.570	8 x 11	340	0.220	8 x 11	555	0.17
82	5 x 11	340	0.220	6.3 x 11	340	0.220	10 x 12	400	0.310
100	6.3 x 11	340	0.220	8 x 11	640	0.130	8 x 11	555	0.17
	8 x 11	300	0.420	8 x 11	370	0.390	8 x 11	555	0.17
120	8 x 11	400	0.380	10 x 12	460	0.320	8 x 15	730	0.12
				8 x 11	550	0.260	8 x 11	400	0.29
				10 x 12	550	0.260	10 x 15	440	0.29
							10 x 12	440	0.29
150	8 x 11	460	0.330	8 x 11	600	0.230	8 x 15	670	0.17
	10 x 12	460	0.330	10 x 12	600	0.230	10 x 15	670	0.170
180	8 x 11	640	0.130	10 x 12	800	0.180	10 x 12	670	0.17
220	10 x 15	630	0.230	10 x 12	690	0.210	10 x 19.5	860	0.150
				8 x 15	800	0.180	10 x 15	860	0.15
				10 x 15	800	0.180	8 x 20	910	0.091
270	10 x 12	865	0.08	10 x 15	800	0.180	10 x 15	910	0.091
330	10 x 12	800	0.190	10 x 19.5	1060	0.130	10 x 15	910	0.091
	8 x 15	800	0.190	8 x 20	1060	0.130	10 x 15	910	0.091
	10 x 15	800	0.190	10 x 15	1060	0.130	10 x 15	910	0.091
	8 x 20	525	0.069				10 x 15	910	0.091
390	10 x 15	1210	0.060	10 x 19.5	1420	0.089	10 x 15	780	0.150
470	10 x 15	1050	0.140	10 x 30	990	0.089	10 x 19.5	1030	0.110
	8 x 20	1050	0.140	10 x 19.5	1420	0.089	10 x 25	1030	0.110
	10 x 19.5	1050	0.140	13 x 25	1060	0.086	10 x 25	1440	0.550
560	10 x 19.5	1400	0.046	12 x 20	1500	0.080	13 x 20	1300	0.086
				10 x 25	1650	0.042	13 x 25	1300	0.086
				10 x 30	1450	0.035	13 x 25	1660	0.055
680	10 x 15.5	1400	0.090	12 x 25	1650	0.070	13 x 20	1660	0.055
	10 x 30	1400	0.090	10 x 30	1450	0.035	12 x 25	1500	0.068
820	12 x 25	1450	0.085	13 x 20	1650	0.070	16 x 20	1500	0.068
	10 x 25	1650	0.042	12 x 30	1750	0.066	12 x 40	2020	0.042
	13 x 20	1900	0.035	12 x 25	1750	0.076	16 x 25	1553	0.025
				13 x 25	1750	0.076	18 x 20	2020	0.042
				18 x 15	1750	0.076			
1000	10 x 30	1650	0.071	12 x 30	2000	0.061	16 x 25	1800	0.060
	12 x 20	1420	0.091	13 x 25	2000	0.061	16 x 32	2120	0.050
	13 x 20	1650	0.071	16 x 20	2000	0.061			
	12 x 25	1650	0.071						
1200	12 x 30	1700	0.078	12 x 35	2200	0.049	16 x 36	2260	0.043
	13 x 25	1700	0.078	13 x 30	2200	0.049	18 x 25	2260	0.043
	18 x 15	1700	0.078						
1500	12 x 30	1950	0.062	12 x 40	2350	0.046	16 x 40	2420	0.035
	13 x 25	1950	0.062	16 x 25	2948	0.028	16 x 36	2420	0.035
	16 x 20	1950	0.062						
1800	13 x 30	2210	0.035	18 x 20	2882	0.034	16 x 40	3635	0.021
				16 x 25	2882	0.034			
2200	12 x 40	2360	0.044	16 x 36	2700	0.044	18 x 32	3635	0.021
	12 x 35	2360	0.044	16 x 32	2700	0.044	18 x 36	3680	0.017
	16 x 25	2495	0.034	18 x 25	2700	0.044			
	18 x 20	2495	0.034						
2700	16 x 25	2552	0.028	16 x 36	3608	0.020	18 x 40	3800	0.014
				18 x 32	3608	0.020			
3300	16 x 36	2700	0.045	18 x 36	3050	0.035			
	16 x 32	2700	0.045	18 x 40	3050	0.035			
	18 x 25	2700	0.045						
3900	16 x 36	3124	0.024	18 x 40	4367	0.015			
	18 x 32	3124	0.024						
4700	18 x 36	3000	0.036						
	18 x 40	3000	0.036						
4900	18 x 40	3781	0.015						
5600	18 x 40	3781	0.015						
6800									
8200									
10000									
15000									

Note : \* 1. D x L : mm

\* 2. Ripple Current : ( mA r.m.s 105°C / 100KHz )

\* 3. ESR ( Ω Max20°C / 100KHz )

## CASE SIZE OF STANDARD PRODUCTS $D \geq \varnothing 6\text{mm}$ with Safety Vent at Can Bottom

CAP. ( $\mu\text{F}$ )	RATED VOLTAGE								
	63			80			100		
	SIZE	Ripple	ESR	SIZE	Ripple	ESR	SIZE	Ripple	ESR
4.7	5 x 11	36	4.600	5 x 11	43	4.200	5 x 11	65	4.100
6.8	5 x 11	52	4.300	5 x 11	62	1.900	5 x 11	55	1.840
							8 x 11	94	1.300
10	5 x 11	77	2.000	6.3 x 11	92	1.400	8 x 11	138	1.100
12	5 x 11	55	1.840				6.3 x 11	115	0.960
15	6.3 x 11	116	1.400	8 x 11	138	1.100	8 x 11	207	0.800
18	6.3 x 11	85	1.500						
22	8 x 11	170	1.200	8 x 11	203	0.640	10 x 12	305	0.530
	6.3 x 11	115	0.960						
27							8 x 11	232	0.504
33	8 x 11	250	0.750	10 x 12	305	0.540	10 x 15	500	0.350
39	8 x 11	232	0.504				8 x 15	288	0.344
47	10 x 12	365	0.560	10 x 15	410	0.360	10 x 19.5	288	0.344
	8 x 11	232	0.504				10 x 12	288	0.344
56	8 x 11	232	0.504				8 x 20	362	0.264
68	10 x 15	500	0.360	10 x 19.5	600	0.260	10 x 25	357	0.248
	8 x 11	232	0.504				10 x 15	357	0.248
82	10 x 12	288	0.344				10 x 19.5	466	0.168
100	10 x 15	288	0.344	10 x 25	795	0.190	10 x 30	531	0.160
	8 x 15	300	0.344				13 x 20	531	0.160
	10 x 12	288	0.344				10 x 25	531	0.160
120	10 x 15	357	0.248	10 x 30	900	0.170	12 x 30	663	0.130
	10 x 19.5	820	0.270						
	10 x 30	663	0.120						
	13 x 20	690	0.128						
150	8 x 20	362	0.264	10 x 30	955	0.150	12 x 30	1200	0.128
	10 x 25	950	0.200						
180	10 x 19.5	466	0.168				13 x 25	784	0.096
220	12 x 25	531	0.160	12 x 30	1200	0.130	16 x 32	905	0.086
	10 x 19.5	466	0.210				12 x 30	905	0.080
	10 x 25	531	0.160				16 x 20	905	0.080
	13 x 20	531	0.160						
270							12 x 35	1050	0.066
							16 x 25	1050	0.066
330	10 x 30	663	0.130	12 x 35	1450	0.088	12 x 40	1180	0.057
	12 x 30	663	0.130				16 x 32	1180	0.062
	13 x 20	663	0.130				18 x 20	1180	0.064
	13 x 25	663	0.130				16 x 36	1180	0.062
390	13 x 25	784	0.096				16 x 32	1570	0.043
							18 x 25	1490	0.046
470	12 x 35	905	0.091	16 x 32	1790	0.063	16 x 36	1790	0.036
	12 x 30	905	0.080				16 x 40	2160	0.048
	13 x 25	392	0.096				18 x 32	1630	0.038
	16 x 20	905	0.073				18 x 36	1630	0.047
560	16 x 25	1250	0.058				18 x 40	2020	0.032
680	16 x 32	1240	0.065	16 x 40	1990	0.060	18 x 36	1790	0.032
	12 x 35	1050	0.066						
	16 x 25	1250	0.058						
	18 x 20	1240	0.064						
820	16 x 36	1490	0.056	18 x 36	2200	0.060	18 x 40	2330	0.029
	12 x 40	1180	0.057						
	16 x 32	1180	0.057						
	18 x 25	1490	0.046						
1000	18 x 36	1570	0.049	18 x 40	2370	0.044			
	16 x 32	1570	0.043						
	16 x 36	1570	0.036						
1200	18 x 40	2520	0.046						
	16 x 40	1630	0.032						
	18 x 32	1630	0.038						
1500	18 x 36	1790	0.032						
1800	18 x 40	2330	0.029						
2200									
3300									
3900									
4700									
6800									
8200									
10000									
15000									

Note : \* 1. D x L : mm

\* 2. Ripple Current : ( mA r.m.s 105°C / 100KHz )

\* 3. ESR (  $\Omega$  Max25°C / 100KHz )

# SY [ Low Impedance and Low ESR ]

105°C 3,000-6,000 Hours, 6.3-100V, Low ESR

## Miniature Aluminum Electrolytic Capacitors

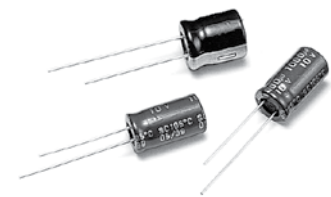

### ELECTRICAL CHARACTERISTICS

Operating Temperature Range : -40 ~ +105°C

Rated Voltage Range : 6.3 ~ 100V

Rated Capacitance Range : 6.8 ~ 15,000µF

Capacitance Tolerance : -20 ~ +20% at 120Hz, 20°C

Leakage Current (Max.) (20°C): I = 0.01CV or 3µA whichever is greater.

(After Rated Voltage Applied for 2 Minutes)

I = Leakage Current (µA), C = Nominal Capacitance (µF), V = Rated Voltage (V)

Dissipation Factor

WV (V) :	6.3	10	16	25	35	50	63	100	
D.F. (%) :	22	19	16	14	12	10	9	8	

When nominal capacitance is over 1,000µF, tan δ shall be added 0.02 to the listed value with increase of every 1000µF.

WV (V) :	Rated Voltage (V)	6.3	10	16	25	35	50	63	100
Impedance :	Z - 25°C / Z + 20°C	4	3	2	2	2	2	2	2
	Z - 40°C / Z + 20°C	8	6	4	3	3	3	3	3

Endurance

Dø :	5ø~6.3ø	8ø~10øx12.5	10øx15~12ø	13ø~18ø
Life :	3000hrs	4000hrs	5000hrs	6000hrs

After the rated voltage has been applied at 105°C for 6000 hours. The capacitors shall meet the following requirements.

- (a) Capacitance Change : Within 25% of Initial Value
- (b) Dissipation Factor : Not Exceeding 200% of Specified Value
- (c) Leakage Current : Not Exceeding the Specified Value

Shelf Life : After having been placed at 105°C without voltage applied for 1000 hours, the capacitors shall meet the same requirements as Endurance.

### DIAGRAM OF DIMENSIONS

Dø	F	dø
5.0	2.0	0.5
6.3	2.5	
8.0	3.5	0.6
10.0	5.0	
12.0		
13.0		
16.0	7.5	0.8
18.0		

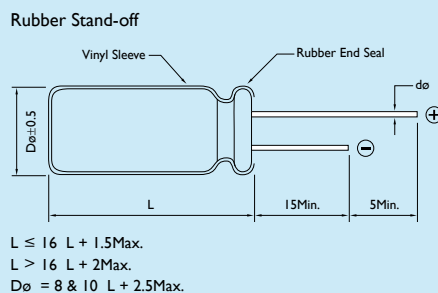

### DESCRIPTION

Features: Low ESR, high permissible ripple current at high frequency and long life than SC

Recommended Applications: Used switching regulator applications in computers

Especially for high frequency

### MULTIPLIER FOR RIPPLE CURRENT

Frequency Coefficient

FREQUENCY (Hz)	120	1K	10K	100K
22~180µF	0.40	0.75	0.90	1.00
220~560µF	0.50	0.85	0.94	1.00
680~1800µF	0.60	0.87	0.95	1.00
2200~3900µF	0.75	0.90	0.95	1.00
4700µF Higher	0.85	0.95	0.98	1.00

### FEATURES

- 3,000~6,000 hours assured
- Low Impedance & long life

Dimensions: mm

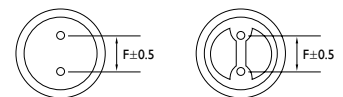

Dø < 20 Dø + 0.5  
Dø ≥ 20 Dø + 1

## CASE SIZE & PERMISSIBLE RIPPLE CURRENT OF STANDARD PRODUCTS

D x L: mm

CAP. (μF)	RATED VOLTAGE WV (SURGE VOLTAGE WV)								
	6.3 (8) SIZE			10 (13) SIZE			16 (20) SIZE		
	SIZE	RIPPLE	ESR	SIZE	RIPPLE	ESR	SIZE	RIPPLE	ESR
56							5 x 11	210	0.580
100				5 x 11	210	0.58	6.3 x 11	250	0.230
120							6.3 x 11	340	0.220
150	5 x 11	210	0.58						
220				6.3 x 11	340	0.22	6.3 x 11	469	0.185
							8 x 11	582	0.150
330	6.3 x 11	340	0.22				8 x 11	640	0.130
470	6.3 x 11	510	0.16	8 x 11	640	0.13	*8 x 15	840	0.087
							8 x 20	950	0.078
							*10 x 12	865	0.080
							10 x 15	1210	0.060
680	8 x 11	640	0.13	8 x 15	840	0.087	8 x 20	1050	0.069
							10 x 15	1210	0.060
820	10 x 12	865	0.08	10 x 12	865	0.08			
1000	8 x 15	840	0.087	8 x 20	1050	0.069	8 x 20	1050	0.069
				10 x 15	1210	0.06	*10 x 15	1210	0.060
							10 x 19.5	1400	0.046
							13 x 15	1450	0.049
1200	8 x 20	1050	0.069	10 x 19.5	1400	0.046	10 x 25	1650	0.042
	10 x 15	1210	0.06						
1500	8 x 20	1050	0.069	10 x 25	1650	0.042	10 x 30	1910	0.031
	*10 x 15	1210	0.06	13 x 15	1450	0.049	13 x 20	1900	0.035
	10 x 19.5	1400	0.046				16 x 15	1940	0.042
1800	13 x 15	1450	0.049						
2200	*10 x 19.5	1400	0.046	10 x 30	1910	0.031	13 x 25	2230	0.027
	10 x 25	1650	0.042	13 x 20	1900	0.042	18 x 15	2210	0.043
				16 x 15	1940	0.042			
2700	10 x 30	1910	0.031	18 x 15	2210	0.043	13 x 30	2650	0.024
	16 x 15	1940	0.042				16 x 20	2530	0.027

Note: 1. Ripple Current: (mA/rms) 105°C, 100KHz

2. ESR: 100KHz / 20°C (Ω Max.)

3. \* Down Size: 1000 Hours less than standard

4. For case size 13 x 15, 16 x 15 and 18 x 15, tolerance of height = ±3 mm

## CASE SIZE & PERMISSIBLE RIPPLE CURRENT OF STANDARD PRODUCTS

D x L: mm

CAP. (μF)	RATED VOLTAGE WV (SURGE VOLTAGE WV)								
	6.3 (8)			10 (13)			16 (20)		
	SIZE	RIPPLE	ESR	SIZE	RIPPLE	ESR	SIZE	RIPPLE	ESR
3300	10 x 25	1650	0.042	10 x 30	1910	0.031	13 x 36	2880	0.020
	13 x 20	1900	0.035	13 x 25	2230	0.027			
3900	13 x 25	2230	0.027	13 x 30	2650	0.024	13 x 40	3350	0.017
	18 x 15	2210	0.043	16 x 20	2530	0.027	16 x 25	2930	0.021
		18 x 20	2860				0.026		
4700	13 x 30	2650	0.024	13 x 35	2880	0.02	16 x 32	3450	0.017
							18 x 25	3140	0.019
5600	13 x 35	2880	0.02	13 x 40	3350	0.017	16 x 36	3610	0.015
	16 x 20	2530	0.027	16 x 25	2930	0.021	18 x 32	4170	0.015
				18 x 20	2860	0.026			
6800	13 x 40	3350	0.017	16 x 32	3450	0.017	16 x 40	4080	0.013
	16 x 25	2930	0.021	18 x 25	3140	0.019			
	18 x 20	2860	0.026						
8200	16 x 32	3450	0.017	16 x 36	3610	0.015	18 x 36	4220	0.014
				18 x 32	4170	0.015			
10000	16 x 36	3610	0.015	16 x 40	4080	0.013	18 x 40	4280	0.012
	18 x 25	3410	0.017	18 x 36	4220	0.014			
12000	18 x 32	4170	0.015	18 x 40	4280	0.012			
15000	18 x 36	4220	0.014						

Note: 1. Ripple Current: (mA/rms) 105°C, 100KHz

2. ESR: 100KHz / 20°C (Ω Max.)

3. For case size 13 x 15, 16 x 15 and 18 x 15, tolerance of height = ±3 mm

## CASE SIZE & PERMISSIBLE RIPPLE CURRENT OF STANDARD PRODUCTS

D x L: mm

CAP. (μF)	RATED VOLTAGE WV (SURGE VOLTAGE WV)								
	25 (32) SIZE			35 (44) SIZE			50 (63) SIZE		
	SIZE	RIPPLE	ESR	SIZE	RIPPLE	ESR	SIZE	RIPPLE	ESR
2.2							5 x 11	85	2.280
4.7				5 x 11	130	2.400	5 x 11	135	2.000
10				5 x 11	275	0.390	5 x 11	100	1.200
22							5 x 11	180	0.700
33				5 x 11	210	0.580	6.3 x 11	245	0.490
47	5 x 11	210	0.580	6.3 x 11	275	0.390	6.3 x 11	300	0.520
56				6.3 x 11	340	0.220	6.3 x 11	295	0.300
68				6.3 x 11	500	0.170			
82				6.3 x 11	540	0.160			
100	6.3 x 11	340	0.220	6.3 x 11	580	0.150	8 x 11	555	0.170
120							8 x 15	730	0.120
150	8 x 11	640	0.160	8 x 11	640	0.130	10 x 12	760	0.120
180							8 x 20	910	0.091
220	8 x 11	640	0.130	*8 x 15	840	0.087	10 x 15	1050	0.084
				10 x 12	865	0.080			
270				8 x 20	1050	0.069	10 x 19.5	1220	0.060
							13 x 15	1260	0.061
330	8 x 15	840	0.087	*10 x 15	1210	0.060	*10 x 19.5	1400	0.058
	10 x 12	865	0.080	10 x 19.5	1400	0.046	10 x 25	1440	0.055
470	8 x 20	1050	0.069	13 x 15	1450	0.049	13 x 20	1660	0.045
	*10 x 12	1050	0.070				16 x 15	1690	0.055
	10 x 15	1210	0.060						
560				10 x 25	1650	0.042	13 x 25	1950	0.034
							18 x 15	1930	0.054
680	10 x 19.5	1400	0.046	10 x 30	1910	0.031	13 x 30	2310	0.030
	13 x 15	1450	0.049	13 x 20	1900	0.035			
				16 x 15	1940	0.042			
820	10 x 25	1650	0.042	13 x 20	1900	0.035	13 x 36	2510	0.025
							16 x 20	2210	0.034

Note: 1. Ripple Current: (mA/rms) 105°C, 100KHz

2. ESR: 100KHz / 20°C (Ω Max.)

3. \* Down Size: 1000 Hours less than standard

4. For case size 13 x 15, 16 x 15 and 18 x 15, tolerance of height = ±3 mm

## CASE SIZE & PERMISSIBLE RIPPLE CURRENT OF STANDARD PRODUCTS

D x L: mm

CAP. (μF)	RATED VOLTAGE WV (SURGE VOLTAGE WV)								
	25 (32) SIZE			35 (44) SIZE			50 (63) SIZE		
	SIZE	RIPPLE	ESR	SIZE	RIPPLE	ESR	SIZE	RIPPLE	ESR
1000	10 × 19.5	1400	0.046	13 × 25	2230	0.027	13 × 40	2920	0.021
	10 × 30	1910	0.031	18 × 15	2210	0.043	16 × 25	2555	0.025
	13 × 20	1900	0.035				18 × 20	2490	0.036
	16 × 15	1940	0.042						
1200	18 × 15	2210	0.043	13 × 30	2650	0.024	16 × 32	3010	0.022
				16 × 20	2530	0.027	18 × 25	2740	0.026
1500	*13 × 20	1900	0.035	13 × 35	2880	0.020	16 × 36	3510	0.019
	13 × 25	2230	0.027						
1800	13 × 30	2650	0.024	13 × 40	3350	0.017	16 × 40	3710	0.016
	16 × 20	2530	0.027	16 × 25	2930	0.021	18 × 32	3635	0.021
				18 × 20	2860	0.026			
2200	13 × 35	2880	0.020	16 × 32	3450	0.017	18 × 36	3680	0.017
	18 × 20	2860	0.026	18 × 25	3140	0.019			
2700	13 × 40	3350	0.017	16 × 36	3610	0.015	18 × 40	3800	0.014
	16 × 25	2930	0.021	18 × 32	4170	0.015			
3300	16 × 32	3450	0.017	16 × 40	4080	0.013			
	18 × 25	3140	0.019	18 × 36	4220	0.014			
3900	18 × 32	4170	0.015	18 × 40	4280	0.012			
4700	18 × 36	4220	0.014						
5600	18 × 40	4280	0.012						

Note: 1. Ripple Current: (mA/rms) 105°C, 100KHz

2. ESR: 100KHz / 20°C (Ω Max.)

3. \* Down Size: 1000 Hours less than standard

4. For case size 13 × 15, 16 × 15 and 18 × 15, tolerance of height = ±3 mm



## CASE SIZE & PERMISSIBLE RIPPLE CURRENT OF STANDARD PRODUCTS

D × L: mm

CAP. (μF)	RATED VOLTAGE WV (SURGE VOLTAGE WV)					
	63 (79) SIZE			100 (125) SIZE		
		RIPPLE	ESR		RIPPLE	ESR
6.8				5 × 11	55	2.30
15	5 × 11	55	2.30	6.3 × 11	115	1.20
27				8 × 11	232	0.63
33	6.3 × 11	115	1.20			
39				8 × 15	300	0.45
47				10 × 12	288	0.43
56	8 × 11	232	0.63	8 × 20	362	0.33
68				10 × 15	357	0.31
82	8 × 15	300	0.45	10 × 19.5	466	0.21
	10 × 12	288	0.43	13 × 15	466	0.23
100				10 × 25	531	0.20
120	8 × 20	362	0.33	10 × 30	663	0.15
	10 × 15	357	0.31	13 × 20	690	0.16
150				16 × 16	795	0.14
180	10 × 19.5	466	0.21	13 × 25	784	0.12
	13 × 15	466	0.23	18 × 15	920	0.12
220	10 × 25	531	0.20	13 × 30	905	0.10
				16 × 20	1040	0.091
270	10 × 30	663	0.15	13 × 35	1050	0.083
	13 × 20	690	0.16	16 × 25	1250	0.073
	16 × 16	795	0.14			
330	13 × 25	784	0.12	13 × 40	1180	0.071
				18 × 20	1240	0.08
390	18 × 16	920	0.12	16 × 32	1570	0.054
				18 × 25	1490	0.057
470	13 × 30	905	0.10	16 × 36	1790	0.045
	16 × 20	1040	0.091	18 × 32	1630	0.047
560	13 × 35	1050	0.083	16 × 40	2020	0.04
	16 × 25	1250	0.073			
680	13 × 40	1180	0.071	18 × 36	1790	0.04
	18 × 20	1240	0.080			
820	16 × 32	1570	0.054	18 × 40	2330	0.036
	18 × 25	1490	0.057			
1000	16 × 36	1790	0.045			
	18 × 32	1630	0.047			
1200	16 × 40	2020	0.04			

Note: 1. Ripple Current: (mA/rms) 105°C, 100KHz

2. ESR: 100KHz / 20°C (Ω Max.)

3. For case size 13 × 15, 16 × 15 and 18 × 15, tolerance of height = ±3 mm

# TC [ Low Impedance and Long Life ]

105°C 8,000-10,000 Hours

## Miniature Aluminum Electrolytic Capacitors

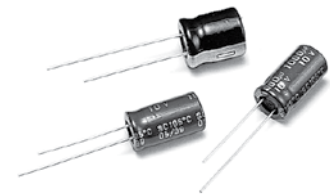

### ELECTRICAL CHARACTERISTICS

Operating Temperature Range : -40 ~ +105°C

Rated Voltage Range : 6.3 ~ 100V

Rated Capacitance Range : 3.3 ~ 8,200μF

Capacitance Tolerance : -20 ~ +20% at 120Hz, 20°C

Leakage Current (Max.) (20°C): I = 0.01CV or 3μA whichever is greater.

(After Rated Voltage Applied for 2 Minutes)

I = Leakage Current (μA), C = Nominal Capacitance (μF), V = Rated Voltage (V)

Dissipation Factor

WV (V) :	6.3	10	16	25	35	50	63	80	100
D.F. (%) :	22	19	16	14	12	10	9	8	8

When nominal capacitance is over 1,000μF, tan δ shall be added 0.02 to the listed value with increase of every 1000μF.

WV (V) :	Rated Voltage (V)	6.3	10	16	25	35	50	63	80	100
Impedance :	Z - 25°C / Z + 20°C	4	3	2	2	2	2	2	2	2
	Z - 40°C / Z + 20°C	8	6	4	3	3	3	3	3	3

Endurance

Dø :	5ø~6.3ø	8ø~10øx12.5	10øx15~12ø	13ø~18ø
Life :	6,000hrs	8,000hrs	10,000hrs	10,000hrs

After the rated voltage has been applied at 105°C for 6,000~10,000 hours. The capacitors shall meet the following requirements.

- (a) Capacitance Change : Within 25% of Initial Value
- (b) Dissipation Factor : Not Exceeding 200% of Specified Value
- (c) Leakage Current : Not Exceeding the Specified Value

Shelf Life : After having been placed at 105°C without voltage applied for 1000 hours, the capacitors shall meet the same requirements as Endurance.

### DIAGRAM OF DIMENSIONS

Dø	F	dø
5.0	2.0	0.5
6.3	2.5	
8.0	3.5	0.6
10.0	5.0	
12.0		
13.0		
16.0	7.5	0.8
18.0		

Rubber Stand-off

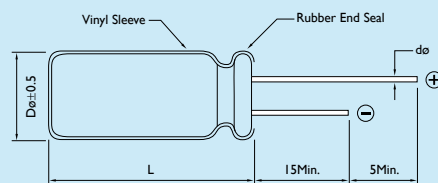

L ≤ 16 L + 1.5Max.  
L > 16 L + 2Max.  
Dø = 8 & 10 L + 2.5Max.

### DESCRIPTION

Features: Low impedance, high permissible ripple and long life

6,000~10,000 hours assured

Switching power supplies, UPS, Ballast, LED lighting

Smaller case size current

### MULTIPLIER FOR RIPPLE CURRENT

Frequency Coefficient

FREQUENCY (Hz)	120	1K	10K	100K
8.2 ~ 33	0.42	0.70	0.90	1.00
47 ~ 270	0.50	0.73	0.92	1.00
330 ~ 680	0.55	0.77	0.94	1.00
820 ~ 1800	0.60	0.80	0.96	1.00
2200 ~ 8200	0.70	0.85	0.98	1.00

### FEATURES

- Low Impedance at high frequency
- Load life of 6,000 to 10,000 hrs

Dimensions: mm

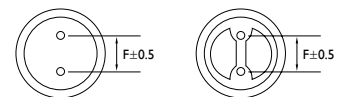

Dø < 20 Dø + 0.5  
Dø ≥ 20 Dø + 1

## CASE SIZE & PERMISSIBLE RIPPLE CURRENT OF STANDARD PRODUCTS

D x L: mm

CAP. (μF)	RATED VOLTAGE WV (SURGE VOLTAGE WV)								
	6.3 (8) SIZE			10 (13) SIZE			16 (20) SIZE		
	SIZE	RIPPLE	ESR	SIZE	RIPPLE	ESR	SIZE	RIPPLE	ESR
390									
470							8 x 12	945	0.062
560							8 x 16	1230	0.049
							10 x 12.5	1340	0.043
680				8 x 12	945	0.062	8 x 16	1250	0.050
							10 x 12.5	1330	0.043
820	8 x 12	945	0.062				8 x 20	1540	0.031
	1540	0.031					10 x 16	1770	0.031
1000				8 x 16	1250	0.050	8 x 20	1540	0.032
				10 x 12.5	1330	0.043	10 x 16	1760	0.031
1200	8 x 16	1250	0.050				10 x 20	1970	0.022
	10 x 12.5	1330	0.043				12.5 x 15	2340	0.020
1500	8 x 20	1500	0.032	8 x 20	1500	0.032	10 x 20	1960	0.022
							12.5 x 15	2340	0.020
1800	10 x 16	1760	0.031	10 x 20	1960	0.022	10 x 25	2250	0.020
2200	10 x 20	1960	0.022	10 x 25	2250	0.020	12.5 x 20	2480	0.019
2700	10 x 25	2250	0.020				12.5 x 25	2710	0.017
3300	10 x 27	2400	0.019	13 x 20	2480	0.019	12.5 x 30	2960	0.014
							16 x 20	2960	0.017
3900	13 x 20	2480	0.019	13 x 25	2900	0.017	13 x 30	3060	0.013
							16 x 20	3060	0.017
4700	13 x 25	2900	0.017	13 x 30	3450	0.014	12.5 x 35	3280	0.013
				16 x 20	3250	0.017	16 x 25	3240	0.014
5600	13 x 30	3450	0.014	13 x 35	3570	0.013	16 x 30	3700	0.012
							18 x 25	3660	0.013
6800	16 x 20	3250	0.017	16 x 25	3630	0.014	16 x 30	3900	0.012
	13 x 35	3570	0.013				18 x 25	3860	0.013
8200	16 x 25	3630	0.014						

Note: 1. Ripple Current: (mA/rms) 105°C, 100KHz

2. ESR: 100KHz / 20°C (Ω Max.)

3. \* Down Size: 1000 Hours less than standard

4. For case size 13 x 15, 16 x 15 and 18 x 15, tolerance of height = ±3 mm

## CASE SIZE & PERMISSIBLE RIPPLE CURRENT OF STANDARD PRODUCTS

D x L: mm

CAP. (μF)	RATED VOLTAGE WV (SURGE VOLTAGE WV)								
	25 (32) SIZE			35 (44) SIZE			50 (63) SIZE		
	SIZE	RIPPLE	ESR	SIZE	RIPPLE	ESR	SIZE	RIPPLE	ESR
220				8 x 15	1020	0.048	8 x 20	1320	0.041
	8 x 11.5	905	0.061	10 x 12.5	1180	0.043	10 x 15	1380	0.042
270	8 x 11.5	965	0.061	8 x 15	1050	0.048	10 x 20	1590	0.036
330	8 x 11.5	945	0.062	10 x 12.5	1340	0.043	10 x 25	1870	0.028
390	8 x 15	1540	0.050	8x 20	1520	0.030	10 x 25	1880	0.031
470	10 x 12.5	1770	0.043	10 x 15	1755	0.030	12.5 x 20	2050	0.030
560	8 x 20	1230	0.032	10 x 20	1970	0.030	12.5 x 25	2420	0.025
	10 x 15	1340	0.031	12.5 x 15	2340	0.025			
680	10 x 15	1770	0.031	10 x 25	2260	0.024	12.5 x 30	2860	0.021
				12.5x 20	2360	0.024			
820	10 x 20	1960	0.022	12.5 x 20	2490	0.024	12.5 x 30	2870	0.020
	12.5 x 15	2010	0.020						
1000	10 x 20	2250	0.020	12.5 x 20	2490	0.024	12.5x 35	3050	0.018
	10 x 25	2260	0.019				16 x 25	3010	0.023
	12.5 x 20	2260	0.019						
1200	12.5 x 20	2370	0.019	12.5 x 25	2910	0.023	16 x 30	3290	0.018
							18 x 25	3070	0.025
1500	12.5 x 20	2480	0.019	12.5 x 30	3450	0.018	16 x 35	3050	0.023
				16 x 20	3260	0.22	18 x 25	3310	0.023
1800	12.5 x 25	2910	0.017	12.5 x 35	3470	0.012	16 x 40	3440	0.016
				16 x 25	3580	0.021	18 x 35	3520	0.021
2200	12.5 x 30	3460	0.014	16 x 25	3640	0.020	18 x 35	3580	0.021
	16 x 20	3250	0.017						
2700	12.5 x 35	3570	0.013	16 x 30	3540	0.011			
	16 x 25	3640	0.014	18 x 25	3650	0.011			
3300	16 x 25	3630	0.014	18 x 35	4090	0.010			
	12.5 x 40	3900	0.012						
3900	16 x 30	3900	0.012	18 x 40	4160	0.010			
	18 x 25	3660	0.013						
4700	16 x 35	3840	0.011						
	18 x 30	4020	0.011						
5600	18 x 35	4090	0.010						
6800	18 x 40	4160	0.010						

Note: 1. Ripple Current: (mA/rms) 105°C, 100KHz

2. ESR: 100KHz / 20°C (Ω Max.)

3. \* Down Size: 1000 Hours less than standard

4. For case size 13 x 15, 16 x 15 and 18 x 15, tolerance of height = ±3 mm

## CASE SIZE & PERMISSIBLE RIPPLE CURRENT OF STANDARD PRODUCTS

D × L: mm

CAP. (μF)	RATED VOLTAGE WV (SURGE VOLTAGE WV)											
	63 (79) SIZE			80 (100) SIZE			100 SIZE					
	SIZE	RIPPLE	ESR	SIZE	RIPPLE	ESR	SIZE	RIPPLE	ESR			
33							8 × 16	465	0.460			
							10 × 12.5	475	0.480			
39	8 × 11.5	420	0.23				10 × 12.5	485	0.38			
47	8 × 11.5	435	0.23				10 × 12.5	510	0.320			
56	8 × 11.5	445	0.23				10 × 12.5	540	0.280			
68	8 × 11.5	460	0.23	8 × 16	585	0.250	8 × 20	675	0.280			
82	8 × 16	560	0.17	10 × 12.5	624	0.230	10 × 16	785	0.190			
100	8 × 16	580	0.17	8 × 20	735	0.190	10 × 20	865	0.130			
	10 × 12.5	570	0.17				12.5 × 15	845	0.140			
120	10 × 12.5	580	0.17	10 × 16	780	0.170	10 × 25	1050	0.120			
150	8 × 20	680	0.12				12.5 × 20	1440	0.085			
	10 × 16	705	0.19									
180	10 × 16	725	0.19	10 × 20	1040	0.120	12.5 × 25	1460	0.066			
				13 × 16	975	0.130						
220	10 × 20	1050	0.086	10 × 25	1170	0.110	12.5 × 25	1620	0.060			
	12.5 × 15	1020	0.080									
270	10 × 20	1080	0.086	13 × 25	1620	0.060	12.5 × 30	1950	0.051			
	12.5 × 15	1045	0.080				16 × 20	1750	0.058			
330	10 × 25	1250	0.076	12 × 35	1450	0.088	12.5 × 35	2140	0.043			
	12.5 × 20	1320	0.066				16 × 25	1920	0.048			
390	12.5 × 20	1350	0.066	13 × 30	1950	0.051	12.5 × 40	2340	0.036			
							16 × 25	2210	0.044			
							18 × 20	1950	0.054			
470	12.5 × 25	1860	0.047	13 × 35	2140	0.043	16 × 30	2010	0.036			
							18 × 25	2270	0.038			
560	12.5 × 30	2050	0.039	13 × 40	2340	0.036	16 × 35	2430	0.032			
				16 × 20	1980	0.047	16 × 25	2210	0.044	18 × 30	2480	0.034
					18 × 20	1950	0.054					
680	12.5 × 35	2250	0.036	16 × 40	1990	0.036	16 × 40	2680	0.030			
	16 × 25	2315	0.035				18 × 35	2860	0.030			
820	12.5 × 40	2430	0.030	16 × 36	2600	0.029	18 × 40	3250	0.028			
	16 × 25	2480	0.035	18 × 25	2270	0.038						
1000	16 × 30	2620	0.026	16 × 40	2860	0.027						
				18 × 32	2470	0.031						
1200	16 × 30	2650	0.034	18 × 36	2860	0.027						
	18 × 25	2610	0.034									
1500	16 × 35	2730	0.023	18 × 40	3510	0.026						
	18 × 30	2780	0.028									
1800	16 × 40	3570	0.023									
	18 × 36	3570	0.024									
2200	18 × 40	3670	0.022									

- Note: 1. Ripple Current: (mA/rms) 105°C, 100KHz  
 2. ESR: 100KHz / 20°C (Ω Max.)  
 3. \* Down Size: 1000 Hours less than standard  
 4. For case size 13 × 15, 16 × 15 and 18 × 15, tolerance of height = ±3 mm

# SL [ Low Impedance and Long Life ]

105°C 3000 ~ 7000 Hours, High Ripple Current and Long Life

## Miniature Aluminum Electrolytic Capacitors

### ELECTRICAL CHARACTERISTICS

Operating Temperature Range: -40 ~ +105°C / -25 ~ +105°C

Rated Voltage Range: 6.3 ~ 100V / 160 ~ 450V

Rated Capacitance Range: 2.2 ~ 18000μF

Capacitance Tolerance: ±20% at 120Hz, 20°C

Leakage Current (Max.) (20°C): I = 0.01CV or 3μA whichever is greater.

(After Rated Voltage Applied for 2 Minutes)

CV ≤ 1000: I = 0.1CV+40μA (max.), CV > 1000: I = 0.04CV+100μA (max.) (After 1 minute)

Dissipation Factor (Max.) (tanδ) (120Hz, 20°C)

WV (V) :	6.3	10	16	25	35	50	63	100	160~250	40~450
D.F. (%) :	22	19	16	14	12	10	9	8	20	24

When nominal capacitance exceeds 1000μF, add 0.02 to the value above for each 1000μF increase.

Temperature Characteristics (Impedance Ratio at 120Hz)

WV (V) :	6.3	10	16	25	35	50	63	100	160~250	400	450
Z-25°C/Z+20°C :	4	3	3	3	3	3	2	2	3	5	6
Z-40°C/Z+20°C :	8	6	4	4	3	3	3	3			

Endurance: After the rated voltage has been applied at 105°C and then has resumed its original condition for 16 hours.

Dø :	6.3ø	8ø	10ø	12.5ø
Load Life :	3000hrs	4000hrs	5000hrs	7000hrs

- (a) Capacitance Change: ±25% of the Initial Measured Value
- (b) Dissipation Factor: ≤ The Initial Specified Value
- (c) Leakage Current: ≤ 2 Times of the Initial Specified Value

Shelf Life: After having been stored at 105°C for 1000 hours, and then has resumed its original condition for 16 hours.

- (a) Capacitance Change: ±25% of the Initial Measured Value
- (b) Dissipation Factor: ≤ The Initial Specified Value
- (c) Leakage Current: ≤ 2 Times of the Initial Specified Value

### DIAGRAM OF DIMENSIONS

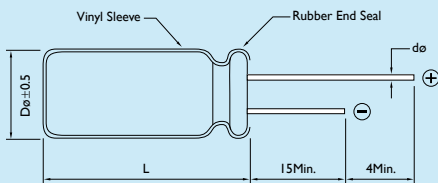

Dø	F	dø
6.3	2.5	0.5
8.0	3.5	0.6
10.0	5.0	
12.5		
16.0	7.5	0.8
18.0		

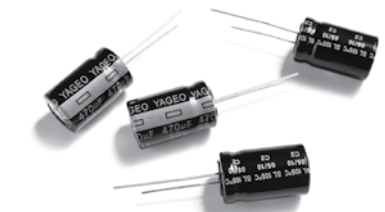

### DESCRIPTION

Excellent Ripple Current Capability

Used in communication equipment, switching power supplies, industrial measuring.

### MULTIPLIER FOR RIPPLE CURRENT

Frequency Coefficient

FREQUENCY (Hz)	120	1K	10K	100K
~180μF	0.40	0.75	0.90	1.00
220~560μF	0.50	0.85	0.94	1.00
680~1800μF	0.60	0.87	0.95	1.00
2200~3900μF	0.75	0.90	0.95	1.00
4700~18000μF	0.85	0.95	0.98	1.00

### FEATURES

- -40°C+105°C / -25°C+105°C
- Low ESR High Reliability
- 3,000~7,000 hours assured
- RoHS compliance

Dimensions: mm

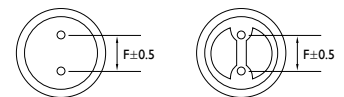

Dø < 20 Dø + 0.5  
Dø ≥ 20 Dø + 1

## CASE SIZE & PERMISSIBLE RIPPLE CURRENT OF STANDARD PRODUCTS

D x L: mm

CAP. (μF)	RATED VOLTAGE WV (SURGE VOLTAGE WV)								
	6.3 (8) SIZE			10 (13) SIZE			16 (20) SIZE		
	SIZE	RIPPLE	ESR	SIZE	RIPPLE	ESR	SIZE	RIPPLE	ESR
100							6.3 x 11	298	0.286
120							6.3 x 11	298	0.286
150				6.3 x 11	298	0.286			
180				6.3 x 11	298	0.286	8 x 11	561	0.169
220	6.3 x 11	298	0.286	6.3 x 11	298	0.286	8 x 11	561	0.169
				8 x 11	561	0.169			
270	6.3 x 11	298	0.286				8 x 11	561	0.169
330	6.3 x 11	298	0.286	8 x 11	561	0.169	8 x 11	561	0.169
	8 x 11	561	0.169						
390	8 x 11	561	0.169	8 x 11	561	0.169	10 x 12	759	0.104
470	8 x 11	561	0.169	8 x 11	561	0.169	10 x 15	737	0.113
560	8 x 11	561	0.169	10 x 12	759	0.104	10 x 15	1061	0.078
680				8 x 15	737	0.113	8 x 20	921	0.090
				10 x 12	759	0.104	10 x 15	1061	0.078
820	8 x 15	737	0.113	10 x 15	1061	0.078	10 x 19.5	1228	0.060
	10 x 15	1061	0.078				12.5 x 15	1272	0.064
1000	10 x 15	1061	0.078	8 x 20	921	0.090	10 x 19.5	1228	0.060
				10 x 15	1061	0.078	10 x 25	1447	0.055
1200	8 x 15	921	0.090	10 x 19.5	1228	0.060	10 x 25	1447	0.055
				12.5 x 15	1272	0.064	16 x 15	1649	0.065
1500	10 x 19.5	1228	0.060	10 x 25	1447	0.055	10 x 30	1675	0.040
	12.5 x 15	1272	0.064				16 x 15	1570	0.072
1800	10 x 25	1447	0.055	10 x 19.5	1228	0.060	12.5 x 25	1863	0.039
				16 x 15	1649	0.065	18 x 15	1687	0.073
2200	10 x 25	1447	0.055	16 x 20	1938	0.046	12.5 x 25	1863	0.039
	16 x 15	1649	0.065				16 x 20	1938	0.046
2700	10 x 30	1675	0.040	12.5 x 25	1863	0.039	12.5 x 30	2214	0.034
	16 x 15	1649	0.065	18 x 15	1772	0.066	16 x 20	1938	0.046
3300	18 x 15	1772	0.066	12.5 x 30	2214	0.034	12.5 x 35	2406	0.029
				16 x 20	1938	0.046	18 x 20	2188	0.044

Note: 1. Ripple Current: (mA/rms) 105°C, 100KHz

2. ESR: 100KHz / 20°C (Ω)

## CASE SIZE & PERMISSIBLE RIPPLE CURRENT OF STANDARD PRODUCTS

D x L: mm

CAP. (μF)	RATED VOLTAGE WV (SURGE VOLTAGE WV)								
	6.3 (8) SIZE			10 (13) SIZE			16 (20) SIZE		
	SIZE	RIPPLE	ESR	SIZE	RIPPLE	ESR	SIZE	RIPPLE	ESR
3900	12.5 x 25	1863	0.039	12.5 x 35	2406	0.029	16 x 25	2238	0.036
				16 x 20	1938	0.046	18 x 20	2188	0.044
4700	12.5 x 30	2214	0.034	12.5 x 40	2798	0.025	16 x 30	2657	0.029
	16 x 20	1938	0.046	16 x 25	2238	0.036	18 x 25	2430	0.031
5600	12.5 x 35	2406	0.029	16 x 25	2238	0.036	16 x 35	2740	0.026
	16 x 20	1938	0.046	18 x 20	2188	0.044	18 x 30	3157	0.026
6800	12.5 x 40	2798	0.025	16 x 30	2657	0.029	16 x 40	3408	0.022
	16 x 30	2657	0.029	18 x 25	2430	0.031			
	18 x 25	2430	0.031						
8200	16 x 35	2740	0.026	16 x 35	2740	0.026	18 x 35	3191	0.025
				18 x 30	3157	0.026			
10000	16 x 35	2740	0.026	18 x 35	3191	0.025	18 x 40	3316	0.020
	18 x 30	3157	0.026						
12000	16 x 40	3408	0.022	18 x 40	3316	0.020			
	18 x 35	3191	0.025						
15000	18 x 35	3191	0.025						
18000	18 x 40	3316	0.020						

Note: 1. Ripple Current: (mA/rms) 105°C, 100KHz

2. ESR: 100KHz / 20°C (Ω)



## CASE SIZE & PERMISSIBLE RIPPLE CURRENT OF STANDARD PRODUCTS

D x L: mm

CAP. (μF)	RATED VOLTAGE WV (SURGE VOLTAGE WV)								
	25 (32) SIZE			35 (44) SIZE			50 (63) SIZE		
	SIZE	RIPPLE	ESR	SIZE	RIPPLE	ESR	SIZE	RIPPLE	ESR
33							6.3 x 11	259	0.390
39							6.3 x 11	259	0.390
47				6.3 x 11	298	0.286	6.3 x 11	259	0.390
56				6.3 x 11	298	0.286	8 x 11	487	0.221
68				6.3 x 11	298	0.286	8 x 11	487	0.221
82	6.3 x 11	298	0.286	8 x 11	561	0.169	8 x 11	487	0.221
100	6.3 x 11	298	0.286	8 x 11	561	0.169	10 x 12	487	0.156
120	8 x 11	561	0.169	8 x 11	561	0.169	8 x 15	667	0.156
							10 x 12	640	0.156
150				8 x 11	561	0.169	10 x 15	667	0.109
180	8 x 11	561	0.169	10 x 12	759	0.104	8 x 15	921	0.118
							10 x 15	798	0.109
220	8 x 11	561	0.169	8 x 15	737	0.113	10 x 19.5	921	0.078
				10 x 12	759	0.104	12 x 15	1070	0.079
270	10 x 12	759	0.104	10 x 15	1061	0.078	10 x 25	1105	0.072
330	8 x 15	737	0.113	8 x 20	921	0.090	10 x 30	1263	0.056
	10 x 12	759	0.104	10 x 15	1061	0.078			
390	10 x 15	1061	0.078	10 x 19.5	1228	0.060	16 x 15	1456	0.072
				12 x 15	1272	0.064			
470	8 x 20	921	0.090	10 x 19.5	1228	0.060	10 x 30	1482	0.056
	10 x 15	1061	0.078				12.5 x 25	1482	0.044
560	10 x 19.5	1228	0.060	10 x 25	1447	0.055	12.5 x 25	1710	0.044
	12.5 x 15	1272	0.064				18 x 15	1710	0.070
680	10 x 19.5	1228	0.060	10 x 30	1482	0.056	12.5 x 30	1693	0.039
				12.5 x 25	1863	0.039	16 x 20	2026	0.044
				16 x 15	1570	0.072			
820	10 x 25	1447	0.055	12.5 x 25	1863	0.039	12.5 x 35	2201	0.033
				18 x 15	1687	0.073	18 x 20	2184	0.047
1000	10 x 30	1675	0.040	12.5 x 25	1920	0.046	12.5 x 35	2561	0.027
	16 x 15	1570	0.072	16 x 20	1938	0.046	16 x 25	2241	0.033
1200	12.5 x 25	1863	0.039	12.5 x 30	2214	0.034	16 x 30	2640	0.029
	18 x 15	1687	0.073	16 x 20	1938	0.046	18 x 25	2403	0.034

## CASE SIZE & PERMISSIBLE RIPPLE CURRENT OF STANDARD PRODUCTS

D x L: mm

CAP. (μF)	RATED VOLTAGE WV (SURGE VOLTAGE WV)								
	25 (32) SIZE			35 (44) SIZE			50 (63) SIZE		
	SIZE	RIPPLE	ESR	SIZE	RIPPLE	ESR	SIZE	RIPPLE	ESR
1500	12.5 x 25	1863	0.039	12.5 x 35	2406	0.029	16 x 35	2763	0.025
	16 x 20	1938	0.046	16 x 25	2238	0.036			
1800	12.5 x 30	2214	0.034	12.5 x 40	2798	0.025	18 x 30	3188	0.027
	16 x 20	1938	0.046	16 x 25	2238	0.036			
2200	12.5 x 35	2406	0.029	16 x 30	2657	0.029	18 x 35	3228	0.022
	18 x 20	2188	0.044	18 x 25	2430	0.031			
2700	16 x 25	2238	0.036	16 x 35	2740	0.026	18 x 40	3333	0.018
				18 x 30	3157	0.026			
3300	16 x 30	2657	0.029	18 x 35	3191	0.025			
	18 x 25	2430	0.031						
3900	16 x 35	2740	0.026	18 x 40	3316	0.020			
	18 x 30	3157	0.026						
4700	18 x 35	3191	0.025						
5600	18 x 40	3316	0.020						

Note: 1. Ripple Current: (mA/rms) 105°C, 100KHz

2. ESR: 100KHz / 20°C (Ω)

## CASE SIZE & PERMISSIBLE RIPPLE CURRENT OF STANDARD PRODUCTS

D × L: mm

CAP. (μF)	RATED VOLTAGE WV (SURGE VOLTAGE WV)								
	63 (79)			100 (125)			160 (200)		
	SIZE	RIPPLE	ESR	SIZE	RIPPLE	ESR	SIZE	RIPPLE	ESR
10							10 × 15	219	2.925
15				6.3 × 11	101	1.560			
22	6.3 × 11	101	1.560				10 × 19.5.5	307	1.950
27				8 × 11	203	0.819			
33	6.3 × 11	101	1.560						
39	8 × 11	203	0.819	8 × 15	263	0.585			
47	8 × 11	203	0.819	10 × 12	253	0.559	12.5 × 25	526	0.897
56	8 × 11	203	0.819	8 × 20	317	0.429			
68	8 × 11	203	0.819	10 × 15	313	0.403			
82	10 × 12	253	0.559	10 × 19.5	409	0.273			
				12.5 × 15	409	0.299			
100	8 × 15	263	0.585	10 × 25	466	0.260	16 × 25	798	0.455
	10 × 12	253	0.559						
120	10 × 15	313	0.403	10 × 30	581	0.195			
150	8 × 20	317	0.429	16 × 15	697	0.182			
180	10 × 19.5	409	0.273	12.5 × 25	688	0.156			
	12.5 × 15	409	0.299	18 × 15	807	0.156			
220	10 × 19.5	409	0.273	12.5 × 30	794	0.130	18 × 35	1202	0.273
	10 × 25	466	0.260	16 × 20	912	0.118			
270	16 × 15	697	0.182	12.5 × 35	921	0.108			
				16 × 25	1096	0.095			
330	10 × 30	581	0.195	12.5 × 40	1035	0.092			
				18 × 20	1088	0.104			
390	12.5 × 25	688	0.156	16 × 30	1377	0.070			
	18 × 15	807	0.156	18 × 25	1307	0.074			
470	12.5 × 30	794	0.130	16 × 32	1570	0.059			
	16 × 20	912	0.118	18 × 30	1430	0.061			
560	16 × 25	1096	0.095	18 × 36	1570	0.052			
680	12.5 × 35	921	0.108	18 × 36	1570	0.052			
	16 × 25	1096	0.095						
	18 × 20	1088	0.104						
820	12.5 × 40	1035	0.092	18 × 40	2044	0.047			
	16 × 30	1377	0.070						
	18 × 25	1307	0.074						
1000	16 × 30	1377	0.070						
	16 × 35	1570	0.059						
1200	16 × 40	1772	0.052						
	18 × 30	1430	0.061						
1500	18 × 35	1570	0.052						
1800	18 × 40	2044	0.047						

Note: 1. Ripple Current: (mA/rms) 105°C, 100KHz

2. ESR: 100KHz / 20°C (Ω)

## CASE SIZE & PERMISSIBLE RIPPLE CURRENT OF STANDARD PRODUCTS

D x L: mm

CAP. (μF)	RATED VOLTAGE WV (SURGE VOLTAGE WV)											
	200 (250)			250 (300)			400 (450)			450 (500)		
	SIZE	RIPPLE	ESR	SIZE	RIPPLE	ESR	SIZE	RIPPLE	ESR	SIZE	RIPPLE	ESR
2.2										10 x 15	96	10.270
3.3							10 x 19.5	171	5.460	10 x 19.5	118	8.060
4.7				10 x 15	145	6.285	10 x 25	193	4.485			
10	10 x 15	219	2.925	10 x 19.5	202	5.200	12.5 x 25	316	2.340	12.5 x 25	228	3.380
22	10 x 19.5	307	1.950	12.5 x 25	316	2.340	16 x 25	500	1.586	16 x 30	421	1.300
33				12.5 x 25	316	2.340	16 x 30	614	0.897	18 x 35	579	0.806
47	12.5 x 25	526	0.897	16 x 25	500	1.105	18 x 30	754	0.650			
100	16 x 30	1017	0.468	18 x 35	820	0.585						
220	18 x 35	1202	0.234	18 x 40	877	0.520						

Note: 1. Ripple Current: (mA/rms) 105°C, 100KHz

2. ESR: 100KHz / 20°C (Ω)

# Miniature Aluminum Electrolytic Capacitors

# ST [ Low Impedance and Long Life ]

105°C 4,000~10,000 Hours, 6.3-63V

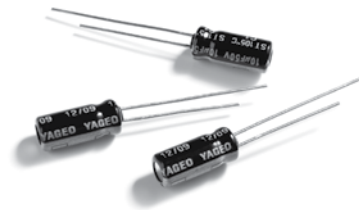

## DESCRIPTION

Applicable for SMPS, Adaptor, Charger, Monitor/ Computer

### MULTIPLIER FOR RIPPLE CURRENT

Frequency Coefficient

FREQUENCY (Hz)	120	1K	10K	100K
6.8~180μF	0.40	0.75	0.90	1.00
220~560μF	0.50	0.85	0.94	1.00
680~1800μF	0.60	0.87	0.95	1.00
2200~3900μF	0.75	0.90	0.95	1.00
4700μF Higher	0.85	0.95	0.98	1.00

## FEATURES

- 105°C 4,000~10,000 hours assured
- Low ESR
- Switching power supplies
- RoHS Compliance

## DIAGRAM OF DIMENSIONS

Dimensions: mm

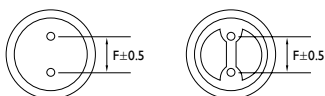

$D\phi < 20 \quad D\phi + 0.5$   
 $D\phi \geq 20 \quad D\phi + 1$

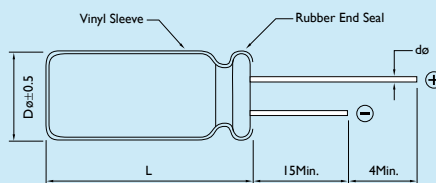

Dø	F	dø
5.0	1.5	0.5
6.3		
8.0		0.6
10.0		
13.0	2.0	
16.0		0.8
18.0		

## ELECTRICAL CHARACTERISTICS

Operating Temperature Range : -40 ~ +105°C

Rated Voltage Range : 6.3 ~ 63V

Rated Capacitance Range : 6.8 ~ 15000μF

Capacitance Tolerance : ±20% at 120Hz, 20°C

Leakage Current (Max.) (20°C):  $I = 0.01CV$  or  $3\mu A$  whichever is greater. (After Rated Voltage Applied for 2 Minutes)  $I$  = Leakage Current ( $\mu A$ ),  $C$  = Nominal Capacitance ( $\mu F$ ),  $V$  = Rated Voltage (V)

Dissipation Factor (Max.) (tanδ) (120Hz, 20°C)

WV (V) :	6.3	10	16	25	35	50	63
D.F. (%) :	22	19	16	14	12	10	9

When nominal capacitance is over 1000μF, tanδ shall be added 0.02 to the listed value with increase of every 1000μF.

Low Temperature Stability Impedance Ratio (Max.)

WV (V) :	6.3	10	16	25	35	50	63
Z - 25°C / Z + 20°C :	4	3	2	2	2	2	2
Z - 40°C / Z + 20°C :	8	6	4	3	3	3	3

Endurance

VDC :	5ø~6.3ø	8ø~10ø	12.5ø~18ø
6.3~10 (V) :	4000hrs	6000hrs	8000hrs
16~100 (V) :	5000hrs	7000hrs	10000hrs

After the rated voltage has been applied at 105°C for 4000~10000 hours. The capacitors shall meet the following requirements.

- Capacitance Change: Within ±25% of Initial Value
- Dissipation Factor: 200% or Less of Initial Specified Value
- Leakage Current: Initial Specified Value or Less

Shelf Life: After having been placed at 105°C without voltage applied for 1000 hours, the capacitors shall meet the same requirements as load life.

## CASE SIZE & PERMISSIBLE RIPPLE CURRENT OF STANDARD PRODUCTS

D x L: mm

CAP. (μF)	RATED VOLTAGE WV (SURGE VOLTAGE WV)											
	6.3 (8)			10 (13)			16 (20)			25 (32)		
	SIZE	RIPPLE	ESR	SIZE	RIPPLE	ESR	SIZE	RIPPLE	ESR	SIZE	RIPPLE	ESR
47										5 x 11	210	0.720
56							5 x 11	210	0.720			
100	5 x 11	150	0.90	5 x 11	210	0.720	6.3 x 11	340	0.380	6.3 x 11	340	0.380
150	5 x 11	210	0.72							8 x 11	640	0.200
220	5 x 11	250	0.40	6.3 x 11	340	0.380	8 x 11	640	0.200	8 x 11	640	0.200
330	6.3 x 11	340	0.38				8 x 15	701	0.160	8 x 15	840	0.160
470	6.3 x 11	400	0.22	8 x 11	640	0.200	8 x 15	840	0.160	10 x 15	1210	0.084
680	8 x 11	640	0.20	8 x 15	840	0.160	10 x 15	1210	0.084	10 x 19.5	1400	0.062
820	8 x 15	840	0.16									
1000	10 x 12	865	0.12	10 x 15	1210	0.084	10 x 19.5	1400	0.062	13 x 20	1900	0.046
1500	8 x 20	1050	0.11	10 x 19.5	1400	0.062	10 x 25	1650	0.052	13 x 25	2230	0.034
	10 x 15	1210	0.084									
2200	10 x 19.5	1400	0.062	10 x 25	1650	0.052	13 x 25	2230	0.034	13 x 35	2880	0.027
2700	10 x 25	1650	0.052	13 x 20	1900	0.046	13 x 30	2650	0.030	16 x 25	2930	0.028
3300	13 x 20	1900	0.046	13 x 25	2230	0.034	13 x 35	2880	0.027	16 x 32	3450	0.025
3900	13 x 25	2230	0.034	13 x 30	2650	0.030	13 x 40	3350	0.024	18 x 32	4170	0.015
4700	13 x 30	2650	0.030	13 x 35	2880	0.027	16 x 25	3450	0.028	18 x 36	4280	0.014
5600	13 x 35	2880	0.027	13 x 40	3550	0.024	16 x 36	3610	0.018			
				16 x 25	2930	0.028	18 x 32	4170	0.015			
6800	13 x 40	3350	0.024	16 x 32	3450	0.025	18 x 36	4220	0.014			
	16 x 25	2930	0.028									
8200	16 x 32	3450	0.025	16 x 36	3610	0.018						
10000	16 x 36	3610	0.018	18 x 36	4220	0.014						
12000	18 x 32	4170	0.015									
15000	18 x 36	4220	0.014									

Note: 1. Ripple Current: (mA/rms) 105°C, 100KHz  
 2. ESR: 100KHz / 20°C (Ω)

## CASE SIZE & PERMISSIBLE RIPPLE CURRENT OF STANDARD PRODUCTS

D x L: mm

CAP. (μF)	RATED VOLTAGE WV (SURGE VOLTAGE WV)								
	35 (44) SIZE			50 (63) SIZE			63 (79) SIZE		
	SIZE	RIPPLE	ESR	SIZE	RIPPLE	ESR	SIZE	RIPPLE	ESR
10							5 x 11	55	2.300
22				5 x 11	210	2.300			
33	5 x 11	210	0.720	6.3 x 11	340	1.200	6.3 x 11	115	1.200
47	6.3 x 11	340	0.380	6.3 x 11	340	1.200			
56							8 x 11	232	0.630
100				8 x 11	555	0.630			
120				8 x 15	730	0.450	10 x 15	357	0.310
150	8 x 11	640	0.200	8 x 20	910	0.330			
180							10 x 19.5	466	0.210
220	8 x 15	840	0.160	10 x 15	1050	0.310	10 x 25	531	0.200
270							10 x 30	663	0.150
							13 x 20	690	0.160
330	10 x 19.5	1400	0.062	10 x 19.5	1400	0.210	13 x 25	784	0.120
470	10 x 25	1650	0.052	10 x 30	1690	0.150	13 x 30	905	0.100
				13 x 20	1660	0.160			
560				13 x 25	1950	0.120	13 x 35	1050	0.083
680	10 x 30	1910	0.044	13 x 30	2310	0.100	13 x 40	1180	0.071
	13 x 20	1900	0.046						
820	13 x 25	2230	0.034	13 x 35	2510	0.083	16 x 32	1570	0.054
1000	13 x 25	2230	0.034	16 x 25	2555	0.073	16 x 36	1790	0.045
				18 x 20	2490	0.036			
1200	13 x 30	2650	0.030	16 x 32	3010	0.054	16 x 40	2020	0.040
1500	13 x 35	2880	0.027	16 x 36	3150	0.045			
1800	13 x 40	3350	0.024	18 x 32	3635	0.047			
2200	16 x 32	3450	0.025	18 x 36	3680	0.040			
2700	16 x 36	3610	0.018	18 x 40	3800	0.036			
3300	18 x 36	4220	0.014						

Note: 1. Ripple Current: (mA/rms) 105°C, 100KHz

2. ESR: 100KHz / 20°C (Ω)

# SD [ High Ripple Current and Slim ]

105°C 5000hrs, Slim type, High ripple current, High reliability

## Miniature Aluminum Electrolytic Capacitors

### ELECTRICAL CHARACTERISTICS

Operating Temperature Range : -25 ~ +105°C / -40 ~ +105°C

Rated Voltage Range : 160 ~ 450V

Rated Capacitance Range : 22 ~ 330μF

Capacitance Tolerance : ±20% at 120Hz, 20°C

Leakage Current (Max.) (20°C):  $I \leq 0.02CV + 1.5\mu A$  whichever is greater.

(After Rated Voltage Applied for 5 Minutes)

$I$  = Leakage Current (μA),  $C$  = Nominal Capacitance (μF),  $V$  = Rated Voltage (V)

Dissipation Factor (Max.) (tanδ) (120Hz, 20°C)

WV (V) :	160	200	250	400	420	450
D.F. (%) :	12	12	12	15	20	20

Temperature Characteristics (Max.) (tanδ) (120Hz, 20°C)

WV (V) :	160	200	250	400	420	450
Z-25°C/Z+20°C :	3	3	3	6	6	6

Endurance:

After the rated voltage and rated ripple current have been applied at 105°C for 5000 hours, the capacitors shall meet the following requirements.

- (a) Capacitance Change : Within ±20% of Initial Value
- (b) Dissipation Factor : ≤ 2 Times of the Initial Specified Value
- (c) Leakage Current : ≤ The Initial Specified Value

Shelf Life: After leaving capacitors under no load at 105°C for 1000 hours.

- (a) Capacitance Change : Within ±20% of Initial Value
- (b) Dissipation Factor : ≤ 2 Times of the Initial Specified Value
- (c) Leakage Current : ≤ 2 Times of the Initial Specified Value

### DIAGRAM OF DIMENSIONS

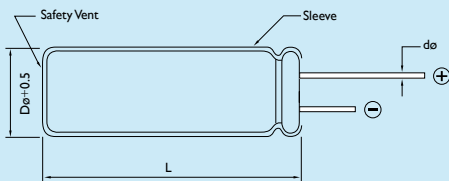

$D\phi = 8 \text{ \& } 10, L + 2.5 \text{ Max.}$

Dø	F	dø	Max
8.0	3.5	0.6	2.0
10.0	5.0	0.6	2.0
12.5	5.0	0.6	2.0

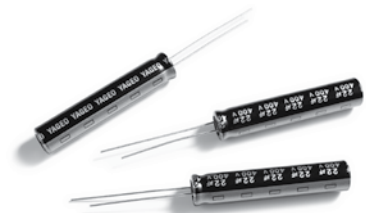

### DESCRIPTION

Applicable for used in super thin TV, with high ripple current capability.

### MULTIPLIER FOR RIPPLE CURRENT

Frequency Coefficient

FREQUENCY (Hz)	60	120	300	1K	10K	100K≤
COEFFICIENT	0.75	1.00	1.25	1.35	1.50	1.50

### FEATURES

105°C 5,000 hours assured

High Voltage

Slim type

Dimensions: mm

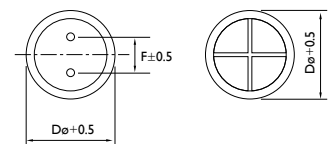

$D\phi < 20 \text{ } D\phi + 0.5$   
 $D\phi \geq 20 \text{ } D\phi + 1$



## CASE SIZE & PERMISSIBLE RIPPLE CURRENT OF STANDARD PRODUCTS

D x L: mm

CAP. (μF)	RATED VOLTAGE WV (SURGE VOLTAGE WV)											
	160 (200)		200 (250)		250 (300)		400 (420)		420 (450)		450 (500)	
	SIZE	RIPPLE	SIZE	RIPPLE	SIZE	RIPPLE	SIZE	RIPPLE	SIZE	RIPPLE	SIZE	RIPPLE
22							8 x 45	225	8 x 50	235	8 x 50	255
27							8 x 50	265	10 x 40	265	10 x 45	285
33					8 x 40	225	10 x 40	300	10 x 45	305	10 x 50	320
39					8 x 45	245	10 x 45	330	10 x 50	350	12.5 x 40	380
47					8 x 50	305	12.5 x 35	400	12.5 x 40	420	12.5 x 45	450
56	8 x 35	260	8 x 45	285	10 x 40	335	12.5 x 40	470	12.5 x 45	480	12.5 x 50	500
68	8 x 40	335	8 x 50	350	10 x 45	380	12.5 x 45	530	12.5 x 50	560	12.5 x 55	585
82	8 x 45	390	10 x 40	460	10 x 50	440	12.5 x 50	610	12.5 x 55	625	12.5 x 60	635
100	8 x 50	470	10 x 45	490	12.5 x 45	530	12.5 x 55	715	12.5 x 60	730		
120	10 x 40	520	10 x 50	570	12.5 x 50	600						
150	10 x 50	650	12.5 x 45	710	12.5 x 55	735						
180	12.5 x 40	745	12.5 x 50	785	12.5 x 60	830						
220	12.5 x 45	830	12.5 x 55	880								
270	12.5 x 50	960	12.5 x 60	1030								
330	12.5 x 55	1100										

Note: I. Ripple Current: (mA/rms) 105°C, 120Hz



# Miniature Aluminum Electrolytic Capacitors

# SV [ High Ripple Current and Slim ]

105°C 10000 - 12000 hrs, High voltage, High ripple current, Slim Type

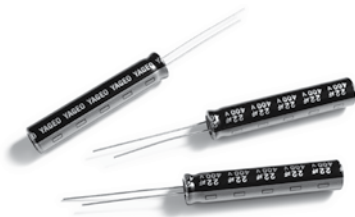

## DESCRIPTION

Applicable for Electronic Ballast

High Temperature Load Life at 105°C for 8000~10000 Hours

### MULTIPLIER FOR RIPPLE CURRENT

Frequency Coefficient

FREQUENCY (Hz)	120	1K	10K	100K
COEFFICIENT	0.5	0.8	0.9	1.0

Temperature Coefficient

TEMPERATURE (°C)	65	85	105
FACTOR	2.10	1.70	1.00

## FEATURES

- High Reliability at High Voltage
- Power Suppliers
- Electronic Lighting Ballast, LED Lighting
- General Industry

## DIAGRAM OF DIMENSIONS

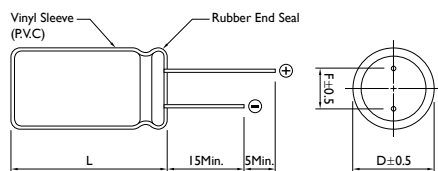

## ELECTRICAL CHARACTERISTICS

Operating Temperature Range : -40 ~ +105°C / -25 ~ +105°C

Rated Voltage Range : 160 ~ 400V / 450V / 160 ~ 450V

Rated Capacitance Range : 3.3 ~ 330μF

Capacitance Tolerance : -20 ~ +20% at 120Hz, 20°C

DC Leakage Current (μA) : I = 0.04CV (μA) + 100μA whichever is greater.  
(After Rated Voltage Applied for 2 Minutes)

Dissipation Factor

WV (V) :	160	200	400	450
D.F (%) :	15	15	20	20

Low Temperature Stability Impedance Ratio (Max.)

WV (V) :	160	200	400	450
Z - 25°C / Z + 20°C	3	3	6	6

After applying rated voltage with rated ripple current for 10000~120000 hours at 105°C the capacitors shall meet the following requirements.

Load Life :	øDxL	Life Time(hrs)
	10.0 ø	10000
	≥ 13.0 ø	12000

- Capacitance Change : Within 20% of Initial Value
- Dissipation Factor : Not Exceeding 200% of Initial Requirement
- Leakage Current : Not Exceeding the Initial Requirement

Shelf Life : After having been placed at 105°C without voltage applied for 1000 hours, the capacitors shall meet the same requirements as Endurance.

Dø	F	dø
10.0	5.0	0.6
12.0		
13.0		
16.0	7.5	0.8
18.0		
22.0	10.0	

### Rubber Stand-off

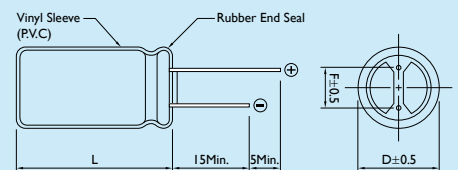

L ≤ 16 L + 1.5Max.  
I > 16 L + 2Max.  
Dø = 8 & 10 L + 2.5Max.

Dø < 20 Dø + 0.5  
Dø ≥ 20 Dø + 1

## CASE SIZE & PERMISSIBLE RIPPLE CURRENT OF STANDARD PRODUCTS

D × L: mm

CAP. (μF)	RATED VOLTAGE WV (SURGE VOLTAGE WV)											
	160 (200)			200 (250)			400 (450)			450 (500)		
	SIZE	RIPPLE	ESR	SIZE	RIPPLE	ESR	SIZE	RIPPLE	ESR	SIZE	RIPPLE	ESR
3.3												
4.7												
6.8							10 × 16	220	39	10 × 20	150	39
10							10 × 19.5	280	26.5	12.5 × 20	320	26.5
22				10 × 19.5	500	9	16 × 20	430	12.1	16 × 25	560	12.1
							10 × 35	430	12.1	10 × 40	560	12.1
33	10 × 19.5	500	6	10 × 19.5	600	6	16 × 25	640	8	16 × 25.5	700	8
							10 × 45	640	8	10 × 50	700	8
47	10 × 30	660	4.2	13 × 20	660	4.2	16 × 32	840	5.6	16 × 32	880	5.6
	12.5 × 20	660	4.2	10 × 30	660	4.2	12.5 × 40	840	5.6	12.5 × 45	880	5.6
68	12 × 25	720	2.9	13 × 25	760	2.9	18 × 25.5	1000	3.9	18 × 31.5	1130	3.9
	16 × 20	760	2.9	16 × 20	760	2.9	12.5 × 50	1000	3.9	12.5 × 50	1130	3.9
				10 × 40	760	2.9						
100	10 × 40	1080	2	16 × 25	1120	2	18 × 36	1280	2.7			
	13 × 30	1080	2	18 × 20.5	1120	2						
	16 × 25	1120	2	10 × 45	1120	2						
	18 × 20	1120	2	12.5 × 36	1120	2						
150	12.5 × 40	1300	1.3	16 × 32	1360	1.3	20 × 41	1770	1.8			
	16 × 32	1360	1.3	18 × 25.5	1360	1.3						
	18 × 25.5	1300	1.3									
220	16 × 32	1400	0.9									
	18 × 25	1400	0.9									
	12.5 × 50	1400	0.9									
330	18 × 36	1380										

Note: I. Ripple Current: (mA/rms) 105°C, 100KHz

# TA [ Low Impedance and Long Life ]

105°C 4,000~10,000 Hours, 6.3-100V

## Miniature Aluminum Electrolytic Capacitors

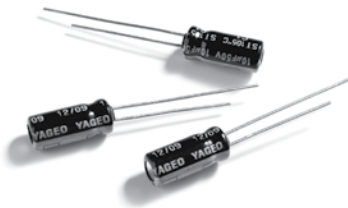

### DESCRIPTION

Applicable for Lighting, Adaptor, Charger

#### MULTIPLIER FOR RIPPLE CURRENT

Frequency Coefficient

FREQUENCY (Hz)	120	1K	10K	100K
6.8~180μF	0.40	0.75	0.90	1.00
220~560μF	0.50	0.85	0.94	1.00
680~1800μF	0.60	0.87	0.95	1.00
2200~3900μF	0.75	0.90	0.95	1.00
4700μF Higher	0.85	0.95	0.98	1.00

### FEATURES

- 105°C 4,000~10,000 hours assured
- Low ESR
- Switching power supplies
- RoHS Compliance

### DIAGRAM OF DIMENSIONS

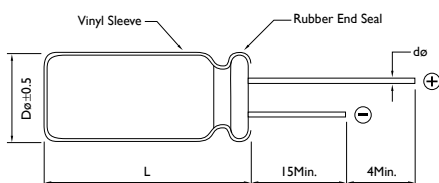

### ELECTRICAL CHARACTERISTICS

Operating Temperature Range : -40 ~ +105°C

Rated Voltage Range : 6.3 ~ 100V

Rated Capacitance Range : 6.8 ~ 8200μF

Capacitance Tolerance : ±20% at 120Hz, 20°C

Leakage Current (Max.) (20°C):  $I = 0.01CV$  or  $3\mu A$  whichever is greater. (After Rated Voltage Applied for 2 Minutes)  $I$  = Leakage Current ( $\mu A$ ),  $C$  = Nominal Capacitance ( $\mu F$ ),  $V$  = Rated Voltage (V)

Dissipation Factor (Max.) (tan $\delta$ ) (120Hz, 20°C)

WV (V) :	6.3	10	16	25	35	50	63	100
D.F. (%) :	22	19	16	14	12	10	9	8

When nominal capacitance is over 1000μF, tan $\delta$  shall be added 0.02 to the listed value with increase of every 1000μF.

Low Temperature Stability Impedance Ratio (Max.)

WV (V) :	6.3	10	16	25	35	50	63	100
Z - 25°C / Z + 20°C :	4	3	2	2	2	2	2	2
Z - 40°C / Z + 20°C :	8	6	4	3	3	3	3	3

Endurance

VDC :	5ø~6.3ø	8ø~10ø	12.5ø~18ø
6.3~10 (V) :	4000hrs	6000hrs	8000hrs
16~100 (V) :	5000hrs	7000hrs	10000hrs

After the rated voltage has been applied at 105°C for 4000~10000 hours. The capacitors shall meet the following requirements.

- Capacitance Change: Within ±25% of Initial Value
- Dissipation Factor: 200% or Less of Initial Specified Value
- Leakage Current: Initial Specified Value or Less

Shelf Life: After having been placed at 105°C without voltage applied for 1000 hours, the capacitors shall meet the same requirements as load life.

Dimensions: mm

Dø	F	dø
5.0	1.5	0.5
6.3		
8.0		0.6
10.0		
13.0	2.0	
16.0		0.8
18.0		

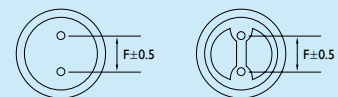

Dø < 20 Dø + 0.5  
Dø ≥ 20 Dø + 1

## CASE SIZE & PERMISSIBLE RIPPLE CURRENT OF STANDARD PRODUCTS

D x L: mm

CAP. (μF)	RATED VOLTAGE WV (SURGE VOLTAGE WV)											
	6.3 (8)			10 (13)			16 (20)			25 (32)		
	SIZE	RIPPLE	ESR	SIZE	RIPPLE	ESR	SIZE	RIPPLE	ESR	SIZE	RIPPLE	ESR
47										5 x 11	210	0.580
56							5 x 11	210	0.580			
100				5 x 11	210	0.580	6.3 x 11	340	0.220	6.3 x 11	340	0.220
150	5 x 11	210	0.580							8 x 11	640	0.200
220				6.3 x 11	340	0.220	8 x 11	640	0.130	8 x 11	640	0.130
330	6.3 x 11	340	0.22				8 x 15	701	0.087	8 x 15	840	0.087
470				8 x 11	640	0.13	8 x 15	840	0.160	10 x 15	1210	0.084
680	8 x 11	640	0.13	8 x 15	840	0.087	10 x 15	1210	0.069	10 x 19.5	1400	0.046
820	8 x 15	840	0.08									
1000	10 x 12	865	0.087	10 x 15	1210	0.06	10 x 19.5	1400	0.046	13 x 20	1900	0.035
1200	8 x 20	1050	0.069	10 x 19.5	1400	0.046	10 x 25	1650	0.042	13 x 25	2230	0.027
	10 x 15	1210	0.060									
1500	10 x 20	1400	0.046	10 x 25	1650	0.042						
2200	10 x 19.5	1400	0.062	10 x 30	1910	0.031	13 x 25	2230	0.027	13 x 35	2880	0.020
2700	10 x 25	1650	0.046	13 x 20	1900	0.035	13 x 30	2650	0.024	16 x 25	2930	0.021
3300	13 x 20	1900	0.035	13 x 25	2230	0.027	13 x 35	2880	0.020	16 x 32	3450	0.017
3900	13 x 25	2230	0.027	13 x 30	2650	0.024	13 x 40	3350	0.017	18 x 32	4170	0.015
4700	13 x 30	2650	0.024	13 x 35	2880	0.027	16 x 32	3450	0.017	18 x 36	4280	0.014
5600	13 x 35	2880	0.020	13 x 40	3550	0.017	16 x 36	3610	0.015			
	16 x 20	2530	0.027	16 x 25	2930	0.021	18 x 32	4170	0.015			
6800	13 x 40	3350	0.017	16 x 32	3450	0.017	18 x 36	4220	0.014			
	16 x 25	2930	0.020	18 x 25	3140	0.019						
8200	16 x 32	3450	0.017	16 x 36	3610	0.015						
10000	16 x 36	3610	0.018	18 x 36	4220	0.012						

Note: 1. Ripple Current: (mA/rms) 105°C, 100KHz

2. ESR: 100KHz / 20°C (Ω)

## CASE SIZE & PERMISSIBLE RIPPLE CURRENT OF STANDARD PRODUCTS

D x L: mm

CAP. (μF)	RATED VOLTAGE WV (SURGE VOLTAGE WV)									
	6.3 (8) SIZE			10 (13) SIZE			16 (20) SIZE			
	RIPPLE	ESR	RIPPLE	ESR	RIPPLE	ESR	RIPPLE	ESR		
56							5 x 11	210	0.580	
100					5 x 11	210	0.58	6.3 x 11	250	0.230
120							6.3 x 11	340	0.220	
150	5 x 11	210	0.58							
220				6.3 x 11	340	0.22	6.3 x 11	469	0.185	
							8 x 11	582	0.150	
330	6.3 x 11	340	0.22				8 x 11	640	0.130	
470	6.3 x 11	510	0.16	8 x 11	640	0.13	*8 x 15	840	0.087	
							8 x 20	950	0.078	
							*10 x 12	865	0.080	
							10 x 15	1210	0.060	
680	8 x 11	640	0.13	8 x 15	840	0.087	8 x 20	1050	0.069	
							10 x 15	1210	0.060	
820	10 x 12	865	0.08	10 x 12	865	0.08				
1000	8 x 15	840	0.087	8 x 20	1050	0.069	8 x 20	1050	0.069	
				10 x 15	1210	0.06	*10 x 15	1210	0.060	
							10 x 19.5	1400	0.046	
							13 x 15	1450	0.049	
1200	8 x 20	1050	0.069	10 x 19.5	1400	0.046	10 x 25	1650	0.042	
	10 x 15	1210	0.06							
1500	8 x 20	1050	0.069	10 x 25	1650	0.042	10 x 30	1910	0.031	
	*10 x 15	1210	0.06	13 x 15	1450	0.049	13 x 20	1900	0.035	
	10 x 19.5	1400	0.046				16 x 15	1940	0.042	
1800	13 x 15	1450	0.049							
2200	*10 x 19.5	1400	0.046	10 x 30	1910	0.031	13 x 25	2230	0.027	
	10 x 25	1650	0.042	13 x 20	1900	0.042	18 x 15	2210	0.043	
				16 x 15	1940	0.042				
2700	10 x 30	1910	0.031	18 x 15	2210	0.043	13 x 30	2650	0.024	
	16 x 15	1940	0.042				16 x 20	2530	0.027	

Note: 1. Ripple Current: (mA/rms) 105°C, 100KHz

2. ESR: 100KHz / 20°C (Ω Max.)

3. \* Down Size: 1000 Hours less than standard

4. For case size 13 x 15, 16 x 15 and 18 x 15, tolerance of height = ±3 mm

## CASE SIZE & PERMISSIBLE RIPPLE CURRENT OF STANDARD PRODUCTS

D × L: mm

CAP. (μF)	RATED VOLTAGE WV (SURGE VOLTAGE WV)								
	6.3 (8) SIZE			10 (13) SIZE			16 (20) SIZE		
	SIZE	RIPPLE	ESR	SIZE	RIPPLE	ESR	SIZE	RIPPLE	ESR
3300	10 × 25	1650	0.042	10 × 30	1910	0.031	13 × 36	2880	0.020
	13 × 20	1900	0.035	13 × 25	2230	0.027			
3900	13 × 25	2230	0.027	13 × 30	2650	0.024	13 × 40	3350	0.017
	18 × 15	2210	0.043	16 × 20	2530	0.027	16 × 25	2930	0.021
							18 × 20	2860	0.026
4700	13 × 30	2650	0.024	13 × 35	2880	0.02	16 × 32	3450	0.017
							18 × 25	3140	0.019
5600	13 × 35	2880	0.02	13 × 40	3350	0.017	16 × 36	3610	0.015
	16 × 20	2530	0.027	16 × 25	2930	0.021	18 × 32	4170	0.015
				18 × 20	2860	0.026			
6800	13 × 40	3350	0.017	16 × 32	3450	0.017	16 × 40	4080	0.013
	16 × 25	2930	0.021	18 × 25	3140	0.019			
	18 × 20	2860	0.026						
8200	16 × 32	3450	0.017	16 × 36	3610	0.015	18 × 36	4220	0.014
				18 × 32	4170	0.015			

Note: 1. Ripple Current: (mA/rms) 105°C, 100KHz

2. ESR: 100KHz / 20°C (Ω Max.)

3. For case size 13 × 15, 16 × 15 and 18 × 15, tolerance of height = ±3 mm



## CASE SIZE & PERMISSIBLE RIPPLE CURRENT OF STANDARD PRODUCTS

D x L: mm

CAP. (μF)	RATED VOLTAGE WV (SURGE VOLTAGE WV)								
	25 (32) SIZE			35 (44) SIZE			50 (63) SIZE		
	SIZE	RIPPLE	ESR	SIZE	RIPPLE	ESR	SIZE	RIPPLE	ESR
2.2							5 × 11	85	2.280
4.7				5 × 11	130	2.400	5 × 11	135	2.000
10				5 × 11	275	0.390	5 × 11	100	1.200
22							5 × 11	180	0.700
33				5 × 11	210	0.580	6.3 × 11	245	0.490
47	5 × 11	210	0.580	6.3 × 11	275	0.390	6.3 × 11	300	0.520
56				6.3 × 11	340	0.220	6.3 × 11	295	0.300
68				6.3 × 11	500	0.170			
82				6.3 × 11	540	0.160			
100	6.3 × 11	340	0.220	6.3 × 11	580	0.150	8 × 11	555	0.170
120							8 × 15	730	0.120
150	8 × 11	640	0.160	8 × 11	640	0.130	10 × 12	760	0.120
180							8 × 20	910	0.091
220	8 × 11	640	0.130	*8 × 15	840	0.087	10 × 15	1050	0.084
				10 × 12	865	0.080			
270				8 × 20	1050	0.069	10 × 19.5	1220	0.060
							13 × 15	1260	0.061
330	8 × 15	840	0.087	*10 × 15	1210	0.060	*10 × 19.5	1400	0.058
	10 × 12	865	0.080	10 × 19.5	1400	0.046	10 × 25	1440	0.055
470	8 × 20	1050	0.069	13 × 15	1450	0.049	13 × 20	1660	0.045
	*10 × 12	1050	0.070				16 × 15	1690	0.055
	10 × 15	1210	0.060						
560				10 × 25	1650	0.042	13 × 25	1950	0.034
							18 × 15	1930	0.054
680	10 × 19.5	1400	0.046	10 × 30	1910	0.031	13 × 30	2310	0.030
	13 × 15	1450	0.049	13 × 20	1900	0.035			
				16 × 15	1940	0.042			
820	10 × 25	1650	0.042	13 × 20	1900	0.035	13 × 36	2510	0.025
							16 × 20	2210	0.034

Note: 1. Ripple Current: (mA/rms) 105°C, 100KHz

2. ESR: 100KHz / 20°C (Ω Max.)

3. \* Down Size: 1000 Hours less than standard

4. For case size 13 × 15, 16 × 15 and 18 × 15, tolerance of height = ±3 mm

## CASE SIZE & PERMISSIBLE RIPPLE CURRENT OF STANDARD PRODUCTS

D × L: mm

CAP. (μF)	RATED VOLTAGE WV (SURGE VOLTAGE WV)								
	25 (32) SIZE			35 (44) SIZE			50 (63) SIZE		
	SIZE	RIPPLE	ESR	SIZE	RIPPLE	ESR	SIZE	RIPPLE	ESR
1000	10 × 19.5	1400	0.046	13 × 25	2230	0.027	13 × 40	2920	0.021
	10 × 30	1910	0.031	18 × 15	2210	0.043	16 × 25	2555	0.025
	13 × 20	1900	0.035				18 × 20	2490	0.036
	16 × 15	1940	0.042						
1200	18 × 15	2210	0.043	13 × 30	2650	0.024	16 × 32	3010	0.022
				16 × 20	2530	0.027	18 × 25	2740	0.026
1500	*13 × 20	1900	0.035	13 × 35	2880	0.020	16 × 36	3510	0.019
	13 × 25	2230	0.027						
1800	13 × 30	2650	0.024	13 × 40	3350	0.017	16 × 40	3710	0.016
	16 × 20	2530	0.027	16 × 25	2930	0.021	18 × 32	3635	0.021
				18 × 20	2860	0.026			
2200	13 × 35	2880	0.020	16 × 32	3450	0.017	18 × 36	3680	0.017
	18 × 20	2860	0.026	18 × 25	3140	0.019			
2700	13 × 40	3350	0.017	16 × 36	3610	0.015	18 × 40	3800	0.014
	16 × 25	2930	0.021	18 × 32	4170	0.015			
3300	16 × 32	3450	0.017	16 × 40	4080	0.013			
	18 × 25	3140	0.019	18 × 36	4220	0.014			
3900	18 × 32	4170	0.015	18 × 40	4280	0.012			
4700	18 × 36	4220	0.014						
5600	18 × 40	4280	0.012						

Note: 1. Ripple Current: (mA/rms) 105°C, 100KHz

2. ESR: 100KHz / 20°C (Ω Max.)

3. \* Down Size: 1000 Hours less than standard

4. For case size 13 × 15, 16 × 15 and 18 × 15, tolerance of height = ±3 mm

## CASE SIZE & PERMISSIBLE RIPPLE CURRENT OF STANDARD PRODUCTS

D x L: mm

CAP. (μF)	RATED VOLTAGE WV (SURGE VOLTAGE WV)					
	63 (79) SIZE			100 (125) SIZE		
		RIPPLE	ESR		RIPPLE	ESR
6.8				5 x 11	55	2.30
15	5 x 11	55	2.30	6.3 x 11	115	1.20
27				8 x 11	232	0.63
33	6.3 x 11	115	1.20			
39				8 x 15	300	0.45
47				10 x 12	288	0.43
56	8 x 11	232	0.63	8 x 20	362	0.33
68				10 x 15	357	0.31
82	8 x 15	300	0.45	10 x 19.5	466	0.21
	10 x 12	288	0.43	13 x 15	466	0.23
100				10 x 25	531	0.20
120	8 x 20	362	0.33	10 x 30	663	0.15
	10 x 15	357	0.31	13 x 20	690	0.16
150				16 x 16	795	0.14
180	10 x 19.5	466	0.21	13 x 25	784	0.12
	13 x 15	466	0.23	18 x 15	920	0.12
220	10 x 25	531	0.20	13 x 30	905	0.10
				16 x 20	1040	0.091
270	10 x 30	663	0.15	13 x 35	1050	0.083
	13 x 20	690	0.16	16 x 25	1250	0.073
	16 x 16	795	0.14			
330	13 x 25	784	0.12	13 x 40	1180	0.071
				18 x 20	1240	0.08
390	18 x 16	920	0.12	16 x 32	1570	0.054
				18 x 25	1490	0.057
470	13 x 30	905	0.10	16 x 36	1790	0.045
	16 x 20	1040	0.091	18 x 32	1630	0.047
560	13 x 35	1050	0.083	16 x 40	2020	0.04
	16 x 25	1250	0.073			
680	13 x 40	1180	0.071	18 x 36	1790	0.04
	18 x 20	1240	0.080			
820	16 x 32	1570	0.054	18 x 40	2330	0.036
	18 x 25	1490	0.057			
1000	16 x 36	1790	0.045			
	18 x 32	1630	0.047			
1200	16 x 40	2020	0.04			

Note: 1. Ripple Current: (mA/rms) 105°C, 100KHz

2. ESR: 100KHz / 20°C (Ω Max.)

3. For case size 13 x 15, 16 x 15 and 18 x 15, tolerance of height = ±3 mm

## CASE SIZE & PERMISSIBLE RIPPLE CURRENT OF STANDARD PRODUCTS

D x L: mm

CAP. (μF)	RATED VOLTAGE WV (SURGE VOLTAGE WV)								
	35 (44) SIZE			50 (63) SIZE			63 (79) SIZE		
	SIZE	RIPPLE	ESR	SIZE	RIPPLE	ESR	SIZE	RIPPLE	ESR
10							5 x 11	55	2.300
22									
33	5 x 11	210	0.058				6.3 x 11	115	1.200
56	6.3 x 11	340	0.022				8 x 11	232	0.630
100				8 x 11	555	0.170			
120				8 x 15	730	0.120	10 x 15	357	0.310
150	8 x 11	640	0.13	10 x 12.5	760	0.120			
180				8 x 20	910	0.091	10 x 19.5	466	0.210
220	8 x 15	840	0.087	10 x 15	1050	0.084	10 x 25	531	0.200
270	8 x 20	1050	0.069	10 x 20	1220	0.06	10 x 30	663	0.150
				13 x 16	1260	0.661	13 x 20	690	0.160
330	10 x 15	1000	0.060	10 x 25	1400	0.055	13 x 25	784	0.120
470	10 x 20	1400	0.046	10 x 30	1690	0.043	13 x 30	905	0.100
	13 x 16	1450	0.049	13 x 20	1660	0.045			
560	10 x 25	1650	0.042	13 x 25	1950	0.034	13 x 35	1050	0.083
680	10 x 30	1910	0.031	13 x 30	2310	0.03	13 x 40	1180	0.071
	13 x 20	1900	0.035						
820	13 x 25	2230	0.030	13 x 35	2510	0.025	16 x 32	1570	0.054
1000	13 x 25	2230	0.027	16 x 25	2555	0.025	16 x 36	1790	0.045
				13 x 40	2920	0.021			
				18 x 20	2490				
1200	13 x 30	2650	0.024	16 x 32	3010	0.022	16 x 40	2020	0.040
1500	13 x 35	2880	0.020	16 x 36	3150	0.019			
1800	13 x 40	3350	0.017	18 x 32	3635	0.021			
2200	16 x 32	3450	0.017	18 x 36	3680	0.017			
2700	16 x 36	3610	0.015	18 x 40	3800	0.014			
3300	18 x 36	4220	0.014						

Note: 1. Ripple Current: (mA/rms) 105°C, 100KHz

2. ESR: 100KHz / 20°C (Ω)

# Miniature Aluminum Electrolytic Capacitors

# TE [Ultra Long Life Series]

105°C 12000 - 20000 hrs, Ultra Long Life, High Temperature



## DESCRIPTION

Applicable for LED Lighting

High Temperature Load Life at 105°C for 12000~20000 Hours

### MULTIPLIER FOR RIPPLE CURRENT

Frequency Coefficient

FREQUENCY (Hz)	120	1K	10K	100K
1~5.6µF	1.0	1.6	1.8	2.0
6.8~18µF	1.0	1.5	1.7	1.9
22~33µF	1.0	1.4	1.5	1.8

## FEATURES

- High Reliability at High Voltage
- Power Suppliers
- Electronic Lighting Ballast, LED Lighting
- General Industry

## DIAGRAM OF DIMENSIONS

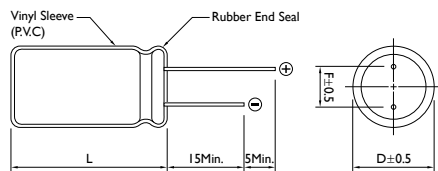

## ELECTRICAL CHARACTERISTICS

Operating Temperature Range : -40 ~ +105°C / -25 ~ +105°C

Rated Voltage Range : 160 ~ 450V

Rated Capacitance Range : 1 ~ 33µF

Capacitance Tolerance : -20 ~ +20% at 120Hz, 20°C

DC Leakage Current (µA) :  $I = 0.04CV (\mu A) + 100\mu A$  whichever is greater.  
(After Rated Voltage Applied for 2 Minutes)

Dissipation Factor

WV (V) :	160	200	400	450
D.F (%) :	24	24	24	24

Low Temperature Stability Impedance Ratio (Max.)

WV (V) :	160	200	400	450
Z - 40°C / Z + 20°C	6	6	7	9

After applying rated voltage with rated ripple current for 12000 ~ 20000 hours at 105°C the capacitors shall meet the following requirements.

Load Life :	øDxL	Life Time(hrs)
	6.3x11, 8x9, 10x9	12000
	8x11, 10x12.5	15000
	10x16, 12.5x20	20000

- Capacitance Change : Within ±30% of the initial measured value
- Dissipation Factor : ≤ 3 times of the initial specified value
- Leakage Current : Initial specified value or less

Shelf Life : After placed at 105°C without voltage applied for 1000 hours, the capacitors shall meet the same requirements as load life.

Dø	F	dø
6.3	2.5	0.5
8.0	3.5	0.6
10.0	5.0	0.6
12.5	5.0	0.8

### Rubber Stand-off

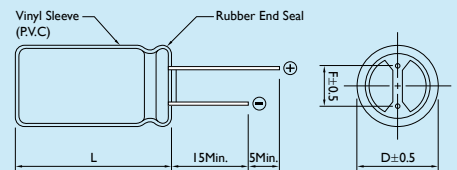

$L \leq 16 L + 1.5 \text{Max.}$   
 $L > 16 L + 2 \text{Max.}$   
 $Dø = 8 \& 10 L + 2.5 \text{Max.}$

$Dø < 20 \quad Dø + 0.5$   
 $Dø \geq 20 \quad Dø + 1$

## CASE SIZE & PERMISSIBLE RIPPLE CURRENT OF STANDARD PRODUCTS

D x L: mm

CAP. (μF)	RATED VOLTAGE WV (SURGE VOLTAGE WV)							
	160 (200) SIZE	RIPPLE	200 (250) SIZE	RIPPLE	250 (300) SIZE	RIPPLE	350 (400) SIZE	RIPPLE
2.2	6.3 x 9	70	6.3 x 11	72	6.3 x 11	75	8 x 11.5	80
3.3	6.3 x 11	85	6.3 x 11	90	6.3 x 11	92	8 x 11.5	100
4.7	6.3 x 11	105			6.3 x 11	120		
5.6	6.3 x 11	110	6.3 x 11	115	8 x 9	130	8 x 16	135
6.8	8 x 9	125	8 x 9	130	8 x 9	160		
8.2		135	8 x 9	145	8 x 9	175	10 x 16	180
10	8 x 9	150	8 x 11	160	8 x 11.5	200	10 x 16	215
15	8 x 11	190	8 x 16	230	10 x 12.5	270	10 x 20	295
	10 x 9	190	10 x 12.5	280				
18			10 x 12.5	113				
22	10 x 12.5	250			10 x 16	380		
27			10 x 16	149				
33	10 x 16	158			10 x 20	570		
47					12.5 x 20	795		

Note: I. Ripple Current: (mA/rms) 105°C, 100KHz

CAP. (μF)	RATED VOLTAGE WV (SURGE VOLTAGE WV)			
	400 (450) SIZE	RIPPLE	450 (500) SIZE	RIPPLE
2.2	8 x 11.5	82	8 x 11.5	88
3.3	8 x 11.5	100	8 x 16	110
4.7	10 x 12.5	126	10 x 12.5	145
5.6	8 x 20	155	10 x 16	180
6.8	8 x 20	170	10 x 16	200
	10 x 16	180		
8.2	10 x 16	190	10 x 20	235
10	10 x 16	220	10 x 20	285
15	12.5 x 20	300		

# Miniature Aluminum Electrolytic Capacitors

## SU [ Higher Temperature Range ]

125°C 2000 Hours, High Temperature

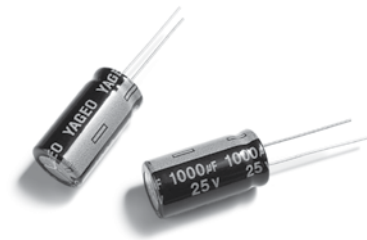

### DESCRIPTION

Applicable for Electronic Ballast, Lighting Ballast

#### MULTIPLIER FOR RIPPLE CURRENT

FREQUENCY (Hz)	120	1K	10K	50K~100K
Cap ≤ 10µF	1.00	1.45	1.65	1.70
10µF < Cap ≤ 100µF	1.00	1.36	1.48	1.53
100µF < Cap ≤ 1,000µF	1.00	1.25	1.35	1.38
1,000µF < Cap	1.00	1.17	1.25	1.28

### ELECTRICAL CHARACTERISTICS

Operating Temperature Range : -40 ~ +125°C

Rated Voltage Range : 10 ~ 63VDC

Rated Capacitance Range : 4.7 ~ 4700µF

Capacitance Tolerance : ±20% at 120Hz, 20°C

Leakage Current (Max.) (20°C):  $I = 0.01CV$  or  $3\mu A$  whichever is greater.

(After Rated Voltage Applied for 2 Minutes)

$I$  = Leakage Current ( $\mu A$ ),  $C$  = Nominal Capacitance ( $\mu F$ ),  $V$  = Rated Voltage (V)

Dissipation Factor (Max.) ( $\tan\delta$ ) (120Hz, 20°C)

WV (V) :	10	16	25	35	50	63
D.F. (%) :	0.20	0.16	0.14	0.12	0.10	0.09

When nominal capacitance is over 1000µF, the value of  $\tan\delta$  shall be increased by 0.02 for every addition of 1000µF.

Low Temperature Stability Impedance Ratio (Max.)

WV (V) :	10	16	25	35	50	63
Z-25°C/Z+20°C :	3	2	2	2	2	2
Z-25°C/Z+20°C :	6	4	4	4	4	4

Endurance: After the rated voltage and rated ripple current have been applied at 125°C for 2000 hours, the capacitors shall meet the following requirements.

- (a) Capacitance Change: Within ±30% of Initial Value
- (b) Dissipation Factor: 300% or Less of Initial Specified Value
- (c) Leakage Current: Initial Specified Value or Less

Shelf Life: After leaving capacitors under no load at 125°C for 1000 hours.

- (a) Capacitance Change: Within ±30% of Initial Value
- (b) Dissipation Factor: 300% or Less of Initial Specified Value
- (c) Leakage Current: 500% or Less of Initial Specified Value

### DIAGRAM OF DIMENSIONS

Dimensions: mm

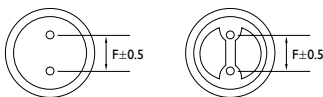

$D\phi < 20$   $D\phi + 0.5$   
 $D\phi \geq 20$   $D\phi + 1$

Dø	F	dø
5.0	1.5	0.5
6.3		
8.0		0.6
10.0		
13.0	2.0	
16.0		0.8

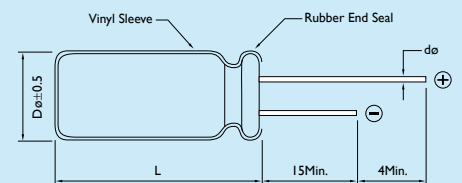

## CASE SIZE & PERMISSIBLE RIPPLE CURRENT OF STANDARD PRODUCTS

D x L: mm

CAP. (μF)	RATED VOLTAGE WV (SURGE VOLTAGE WV)											
	10 (13)		16 (20)		25 (32)		35 (44)		50 (63)		63 (79)	
	SIZE	RIPPLE	SIZE	RIPPLE	SIZE	RIPPLE	SIZE	RIPPLE	SIZE	RIPPLE	SIZE	RIPPLE
4.7											5 x 11	92
10									5 x 11	92	6.3 x 11	145
22							5 x 11	92	6.3 x 11	145	8 x 11	210
33					5 x 11	92	6.3 x 11	145	8 x 11	210	10 x 12	300
47			5 x 11	92	6.3 x 11	145	8 x 11	210	10 x 12	300	10 x 15	410
100	5 x 11	92	6.3 x 11	145	8 x 11	210	10 x 12	300	10 x 15	410	10 x 19.5	510
150	6.3 x 11	145	8 x 11	210	10 x 12	300	10 x 15	410	10 x 19.5	510	13 x 20	740
220	8 x 11	210	10 x 12	300	10 x 15	410	10 x 19.5	510	13 x 20	740	13 x 25	1070
330	10 x 12	300	10 x 15	410	10 x 19.5	510	13 x 20	740	13 x 25	1070	16 x 25	1100
470	10 x 15	410	10 x 19.5	510	13 x 20	740	16 x 25	1100	16 x 25	1100	16 x 32	1200
1000	10 x 19.5	510	13 x 20	740	16 x 25	1100	16 x 32	1200	16 x 32	1200		
2200	13 x 25	1070	16 x 25	1100	16 x 32	1200						
3000	16 x 25	1100	16 x 32	1200								
4700	16 x 32	1200										

Note: I. Ripple Current: (mA/rms) 125°C, 120KHz



# Miniature Aluminum Electrolytic Capacitors

# SW [ Higher Temperature Range & Long Life ]

125°C 2000 ~ 5000 Hours, High Temperature Long Life

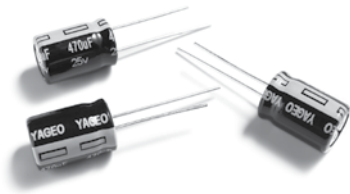

## DESCRIPTION

Applicable for Electronic Ballast, Lighting Ballast

### MULTIPLIER FOR RIPPLE CURRENT

FREQUENCY (Hz)	120	1K	10K	100K
Cap ≤ 10μF	0.40	0.75	0.90	1.00
10μF < Cap ≤ 100μF	0.50	0.85	0.95	1.00
100μF < Cap ≤ 1,000μF	0.60	0.88	0.96	1.00
1,000μF < Cap	0.75	0.90	0.98	1.00

## ELECTRICAL CHARACTERISTICS

Operating Temperature Range : -40 ~ +125°C

Rated Voltage Range : 10 ~ 63VDC

Rated Capacitance Range : 47 ~ 4700μF

Capacitance Tolerance : ±20% at 120Hz, 20°C

Leakage Current (Max.) (20°C):  $I = 0.01CV$  or  $3\mu A$  whichever is greater.  
(After Rated Voltage Applied for 2 Minutes)

$I$  = Leakage Current ( $\mu A$ ),  $C$  = Nominal Capacitance ( $\mu F$ ),  $V$  = Rated Voltage (V)

Dissipation Factor (Max.) ( $\tan\delta$ ) (120Hz, 20°C)

WV (V) :	10	16	25	35	50	63
D.F. (%) :	20	16	14	12	10	9

When nominal capacitance is over 1000μF, the value of  $\tan\delta$  shall be increased by 0.02 for every addition of 1000μF.

Low Temperature Stability Impedance Ratio (Max.)

WV (V) :	10	16	25	35	50	63
Z-25°C/Z+20°C :	3	2	2	2	2	2
Z-40°C/Z+20°C :	6	4	4	4	4	3

Endurance: After the rated voltage and rated ripple current have been applied at 125°C for 2000~5000 hours, the capacitors shall meet the following requirements.

D $\phi$ :	8 $\phi$	10 $\phi$	≥13 $\phi$
Load Life :	2000hrs	3000hrs	5000hrs

- (a) Capacitance Change: Within ±30% of Initial Value
- (b) Dissipation Factor: 300% or Less of Initial Specified Value
- (c) Leakage Current: Initial Specified Value or Less

Shelf Life: After leaving capacitors under no load at 125°C for 1000 hours.

- (a) Capacitance Change: Within ±30% of Initial Value
- (b) Dissipation Factor: 300% or Less of Initial Specified Value
- (c) Leakage Current: 500% or Less of Initial Specified Value

## DIAGRAM OF DIMENSIONS

Dimensions: mm

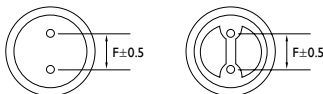

$D\phi < 20$   $D\phi + 0.5$   
 $D\phi \geq 20$   $D\phi + 1$

D $\phi$	F	d $\phi$
8.0	1.5	0.6
10.0		
13.0	2.0	
16.0		0.8
18.0		

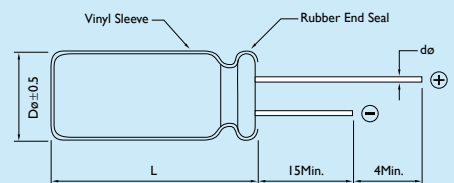

## CASE SIZE & PERMISSIBLE RIPPLE CURRENT OF STANDARD PRODUCTS

D x L: mm

CAP. (μF)	RATED VOLTAGE WV (SURGE VOLTAGE WV)											
	10 (13)			16 (20)			25 (32)			35 (44)		
	SIZE	RIPPLE	ESR	SIZE	RIPPLE	ESR	SIZE	RIPPLE	ESR	SIZE	RIPPLE	ESR
100							8 x 11	340	0.200	10 x 12	340	0.140
220	8 x 11	340	0.200	8 x 11	340	0.200	10 x 12	500	0.140	10 x 15	500	0.090
330	10 x 12	500	0.140	10 x 12	500	0.140	10 x 15	630	0.090	10 x 19	770	0.070
470	10 x 15	630	0.090	10 x 19	770	0.070	10 x 19	770	0.070	13 x 20	920	0.042
820										12.5 x 22	1820	0.044
1000	10 x 19	770	0.070	13 x 20	920	0.042	13 x 25	1250	0.038	16 x 25	1380	0.028
1500										13 x 25	1780	0.024
2200	13 x 25	1250	0.038	16 x 25	1380	0.028	16 x 32	1450	0.025			
3300	16 x 25	1380	0.028	16 x 32	1450	0.025						
4700	16 x 32	1450	0.025	18 x 32	1720	0.018						

Note: 1. Ripple Current: (mA/rms) 125°C, 100KHz  
 2. ESR: 100KHz / 20°C (Ω)

## CASE SIZE & PERMISSIBLE RIPPLE CURRENT OF STANDARD PRODUCTS

D x L: mm

CAP. (μF)	RATED VOLTAGE WV (SURGE VOLTAGE WV)					
	50 (63)			63 (79)		
	SIZE	RIPPLE	ESR	SIZE	RIPPLE	ESR
47	8 x 11	245	0.680	8 x 11	245	0.068
100	10 x 12	415	0.360	10 x 15	455	0.300
220	10 x 19	491	0.180	13 x 20	665	0.120
330	13 x 20	665	0.120	13 x 25	995	0.100
470	13 x 25	995	0.100	16 x 25	1000	0.084
1000	16 x 32	1280	0.078			

Note: 1. Ripple Current: (mA/rms) 125°C, 100KHz  
 2. ESR: 100KHz / 20°C (Ω)

# Large Can Aluminum Electrolytic Capacitors

## LH [General]

Snap-in Terminal 85°C 2000hrs assured



### DESCRIPTION

Endurance : 85°C, 2000 Hours

For Printed Circuit Board High-Performance Aluminum Electrolytic Power Supply Input and Output Filter Capacitors

Ideally suitable for using in switching power supplies and other industrial / commercial applications

### MULTIPLIER FOR RIPPLE CURRENT

Frequency Coefficient

FREQUENCY (Hz)	50	60	120	1K	10K
6.3~100V	0.88	0.90	1.00	1.15	1.16
160~250V	0.75	0.78	1.00	1.16	1.23
350~450V	0.74	0.76	1.00	1.10	1.15
500V	0.72	0.74	1.00	1.05	1.10

### ELECTRICAL CHARACTERISTICS

Operating Temperature Range	-40 to +85°C	-25 to +85°C																								
Rated Voltage Range	6.3 ~ 100V	160 to 450VDC																								
Rated Capacitance	820 ~ 120000µF	56 ~ 2200µF																								
Capacitance Tolerance	±20% at 120Hz, 20°C																									
Leakage Current	I = 0.02CV or 3mA Whichever is smaller. (After 5 Minutes Application of DC Working Voltage at 20°C)																									
Dissipation Factor (tanδ)	<table border="1"> <thead> <tr> <th>Rate Voltage (V)</th> <th>6.3</th> <th>10</th> <th>16</th> <th>25</th> <th>35</th> <th>50</th> <th>63-100</th> <th>160-400</th> <th>450-500</th> </tr> </thead> <tbody> <tr> <td>D.F. (%)</td> <td>60</td> <td>55</td> <td>55</td> <td>45</td> <td>35</td> <td>30</td> <td>25</td> <td>15</td> <td>20</td> </tr> </tbody> </table>		Rate Voltage (V)	6.3	10	16	25	35	50	63-100	160-400	450-500	D.F. (%)	60	55	55	45	35	30	25	15	20				
Rate Voltage (V)	6.3	10	16	25	35	50	63-100	160-400	450-500																	
D.F. (%)	60	55	55	45	35	30	25	15	20																	
Low Temperature Stability	Measurement frequency: 120Hz																									
Impedance Ratio (Max.)	<table border="1"> <thead> <tr> <th>Rate Voltage (V)</th> <th>6.3~16</th> <th>25</th> <th>35</th> <th>50~63</th> <th>80~10</th> <th>160~400</th> <th>450</th> </tr> </thead> <tbody> <tr> <td>Z(-25°C) / Z(20°C)</td> <td>3</td> <td>3</td> <td>3</td> <td>2</td> <td>2</td> <td>4</td> <td>8</td> </tr> <tr> <td>Z(-40°C) / Z(20°C)</td> <td>12</td> <td>10</td> <td>8</td> <td>6</td> <td>5</td> <td>-</td> <td>-</td> </tr> </tbody> </table>		Rate Voltage (V)	6.3~16	25	35	50~63	80~10	160~400	450	Z(-25°C) / Z(20°C)	3	3	3	2	2	4	8	Z(-40°C) / Z(20°C)	12	10	8	6	5	-	-
Rate Voltage (V)	6.3~16	25	35	50~63	80~10	160~400	450																			
Z(-25°C) / Z(20°C)	3	3	3	2	2	4	8																			
Z(-40°C) / Z(20°C)	12	10	8	6	5	-	-																			
Endurance	After the rated voltage and rated ripple current have been applied at 85°C for 2000 hours, the capacitors shall meet the following requirements. (a) Capacitance Change: Within 20% of the Initial Value (b) Dissipation Factor: 200% or Less of Initial Specified Value (c) Leakage Current: Initial Specified Value or Less																									
Shelf Life	After having been placed at 85°C without voltage applied for 1000 hours, the capacitors shall meet the same requirements as Endurance.																									

### DIAGRAM OF DIMENSIONS

Unit: mm

Location of P.C.B. Holes

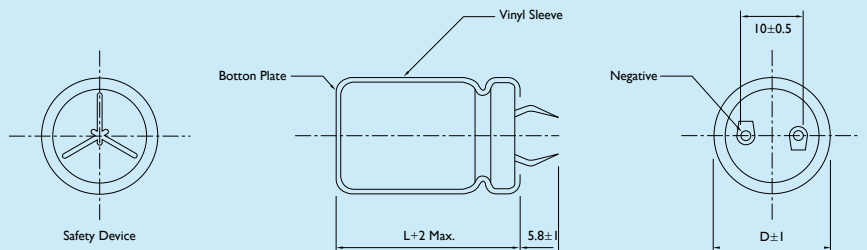
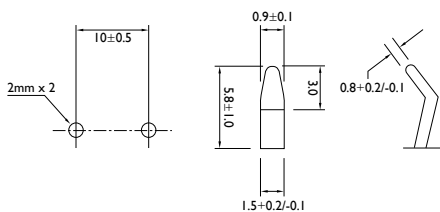

## CASE SIZE & PERMISSIBLE RIPPLE CURRENT OF STANDARD PRODUCTS

D × L: mm

CAP. (μF)	RATED VOLTAGE WV (SURGE VOLTAGE WV)							
	6.3 (8) SIZE		10 (13) SIZE		16 (20) SIZE		25 (32) SIZE	
		RIPPLE		RIPPLE		RIPPLE		RIPPLE
5600							22 × 25	2.20
6800							22 × 30	2.40
							25 × 25	2.45
8200					22 × 25	2.60	22 × 35	2.70
							25 × 25	2.75
10000					22 × 30	2.70	22 × 40	3.10
					25 × 25	2.75	25 × 30	3.15
							30 × 25	3.20
12000			22 × 25	2.40	22 × 30	2.90	22 × 45	3.50
					25 × 25	2.95	25 × 35	3.45
							30 × 30	3.50
							35 × 25	3.55
15000	22 × 25	2.44	22 × 30	2.75	22 × 35	3.30	22 × 50	4.00
			25 × 25	2.75	25 × 30	3.45	25 × 40	3.95
					30 × 25	3.50	30 × 35	4.00
							35 × 30	4.05
18000	22 × 30	2.60	22 × 35	3.15	22 × 40	3.70	25 × 45	4.45
	25 × 25	2.62	25 × 25	3.05	25 × 35	3.75	30 × 35	4.45
					30 × 30	3.80	35 × 30	4.60
22000	22 × 30	3.06	22 × 40	3.55	22 × 50	4.35	30 × 40	5.20
	25 × 25	3.07	25 × 30	3.50	25 × 40	4.30	35 × 35	5.15
			30 × 25	3.55	30 × 30	4.25	30 × 45	5.95
					35 × 25	4.20	35 × 40	5.90
27000	22 × 35	3.49	22 × 45	4.05	25 × 45	4.70	30 × 50	6.70
	25 × 30	3.52	25 × 35	4.00	30 × 35	4.65	35 × 45	6.75
	30 × 25	3.57	30 × 30	4.05	35 × 30	4.65		
33000	22 × 40	3.97	22 × 50	4.60	30 × 40	5.35	35 × 50	7.55
	25 × 35	4.02	25 × 40	4.55	35 × 30	5.40		
	30 × 30	4.05	30 × 30	4.50				
	35 × 25	4.10	35 × 25	4.50				

Note: I. Ripple Current: (A/rms) 85°C, 120Hz

## CASE SIZE & PERMISSIBLE RIPPLE CURRENT OF STANDARD PRODUCTS

D x L: mm

CAP. (μF)	RATED VOLTAGE WV (SURGE VOLTAGE WV)							
	6.3 (8) SIZE		10 (13) SIZE		16 (20) SIZE		25 (32) SIZE	
		RIPPLE		RIPPLE		RIPPLE		RIPPLE
39000	22 x 50	4.56	25 x 45	5.10	30 x 45	6.00		
	25 x 40	4.50	30 x 35	5.05	35 x 35	5.95		
	30 x 30	4.46	35 x 30	5.05				
	35 x 25	4.51						
47000	25 x 45	5.09	25 x 50	5.75	30 x 50	6.80		
	30 x 35	5.06	30 x 40	5.70	35 x 40	6.75		
	35 x 30	5.03	35 x 30	5.65				
56000	25 x 50	5.71	30 x 45	6.45	35 x 45	7.60		
	30 x 40	5.70	35 x 35	6.40				
	35 x 30	5.75						
68000	30 x 45	6.48	30 x 50	7.05	35 x 50	8.00		
	35 x 35	6.42	35 x 40	7.10				
82000	30 x 50	7.32	35 x 50	7.50				
	35 x 40	7.29						
100000	35 x 45	8.31						
120000	35 x 50	8.60						

Note: I. Ripple Current: (A/rms) 85°C, 120Hz

## CASE SIZE & PERMISSIBLE RIPPLE CURRENT OF STANDARD PRODUCTS

D × L: mm

CAP. (μF)	RATED VOLTAGE WV (SURGE VOLTAGE WV)							
	35 (44) SIZE		50 (63) SIZE		63 (79) SIZE		80 (100) SIZE	
		RIPPLE		RIPPLE		RIPPLE		RIPPLE
1200							22 × 25	1.65
1500							22 × 30	1.90
							25 × 25	1.90
1800					22 × 25	1.85	22 × 35	2.20
							25 × 30	2.20
							30 × 25	2.20
2200			22 × 25	1.90	22 × 30	2.30	22 × 40	2.45
					25 × 25	2.30	25 × 30	2.45
							30 × 25	2.50
2700			22 × 30	2.10	22 × 35	2.45	22 × 45	2.80
			25 × 25	2.20	25 × 30	2.45	25 × 35	2.80
					30 × 25	2.50	30 × 30	2.85
							35 × 25	2.85
3300			22 × 30	2.35	22 × 40	2.60	22 × 50	3.15
			25 × 25	2.35	25 × 30	2.65	25 × 40	3.20
					30 × 25	2.70	30 × 30	3.20
							35 × 25	3.20
3900	22 × 25	2.20	22 × 35	2.65	22 × 45	2.95	25 × 45	3.60
			25 × 30	2.65	25 × 35	2.95	30 × 35	3.60
			30 × 25	2.65	30 × 30	3.00	35 × 30	3.60
4700	22 × 30	2.40	22 × 40	3.00	22 × 50	3.40	25 × 50	4.05
	25 × 25	2.40	25 × 35	3.00	25 × 40	3.35	30 × 40	4.05
			30 × 25	2.95	30 × 30	3.35	35 × 35	4.10
					35 × 25	3.40		
5600	22 × 35	2.75	22 × 45	3.35	25 × 45	3.70	30 × 45	4.55
	25 × 25	2.75	25 × 40	3.35	30 × 35	3.75	35 × 35	4.50
			30 × 30	3.35	35 × 30	3.75		
			35 × 25	3.40				

Note: I. Ripple Current: (A/rms) 85°C, 120Hz

## CASE SIZE & PERMISSIBLE RIPPLE CURRENT OF STANDARD PRODUCTS

D x L: mm

CAP. (μF)	RATED VOLTAGE WV (SURGE VOLTAGE WV)							
	35 (44) SIZE		50 (63) SIZE		63 (79) SIZE		80 (100) SIZE	
		RIPPLE		RIPPLE		RIPPLE		RIPPLE
6800	22 x 40	2.85	22 x 50	3.80	30 x 40	4.25	30 x 50	5.15
	25 x 30	2.85	25 x 40	3.80	35 x 30	4.20	35 x 40	5.15
	30 x 25	2.90	30 x 30	3.80				
			30 x 35	3.85				
			35 x 30	3.85				
8200	22 x 45	3.15	25 x 50	4.35	30 x 45	4.80	35 x 45	5.85
	25 x 35	3.10	30 x 40	4.35	35 x 35	4.80		
	30 x 30	3.15	35 x 30	4.40				
10000	22 x 50	3.55	30 x 45	5.00	30 x 50	5.50	35 x 50	6.60
	25 x 40	3.50	35 x 35	4.95	35 x 40	5.45		
	30 x 30	3.45						
	35 x 25	3.40						
12000	25 x 45	3.95	30 x 50	5.60	35 x 45	6.20		
	30 x 35	4.00	35 x 40	5.55				
	35 x 30	4.05						
15000	25 x 50	4.95	35 x 45	6.45				
	30 x 40	4.95						
	35 x 35	5.00						
18000	30 x 45	5.50	35 x 50	6.70				
	35 x 40	5.55						
22000	30 x 50	6.00						
	35 x 45	6.05						
27000	35 x 50	6.90						

Note: I. Ripple Current: (A/rms) 85°C, 120Hz

## CASE SIZE & PERMISSIBLE RIPPLE CURRENT OF STANDARD PRODUCTS

D × L: mm

CAP. (μF)	RATED VOLTAGE WV (SURGE VOLTAGE WV)							
	100 (125) SIZE		160 (200) SIZE		180 (225) SIZE		200 (250) SIZE	
		RIPPLE		RIPPLE		RIPPLE		RIPPLE
180					22 × 20	1.00	22 × 25	0.95
220					22 × 25	1.10	22 × 25	1.10
270			22 × 25	1.15	22 × 25	1.25	22 × 25	1.25
					25 × 20	1.25	22 × 30	1.25
							25 × 25	1.25
330			22 × 25	1.40	22 × 25	1.40	22 × 25	1.45
			25 × 20	1.35	22 × 30	1.40	22 × 30	1.45
					25 × 25	1.40	25 × 25	1.45
390			22 × 30	1.55	22 × 30	1.60	22 × 30	1.60
			25 × 25	1.55	25 × 25	1.60	25 × 25	1.55
			30 × 25	1.50				
470			22 × 30	1.75	22 × 35	1.80	22 × 35	1.80
			25 × 25	1.75	25 × 30	1.80	25 × 30	1.80
			30 × 25	1.70	30 × 25	1.80	30 × 25	1.80
560			22 × 30	1.95	22 × 35	2.00	22 × 40	2.00
			25 × 30	1.95	22 × 40	2.00	25 × 35	2.00
			30 × 25	1.90	25 × 30	1.95	30 × 25	2.00
					30 × 25	2.00		
680			22 × 40	2.20	22 × 45	2.25	22 × 45	2.35
			25 × 30	2.20	25 × 35	2.20	25 × 35	2.30
			30 × 25	2.15	30 × 30	2.20	30 × 30	2.30
					35 × 25	2.20	35 × 25	2.30
820	22 × 25	1.85	22 × 45	2.50	22 × 50	2.55	25 × 40	2.60
			25 × 35	2.55	25 × 40	2.55	25 × 45	2.60
			30 × 30	2.50	30 × 30	2.60	30 × 30	2.60
			35 × 25	2.50	30 × 35	2.60	30 × 35	2.60
					35 × 25	2.60	35 × 30	2.60
1000	22 × 30	2.10	22 × 50	2.85	25 × 45	2.85	25 × 45	3.00
	25 × 25	2.10	25 × 40	2.80	30 × 35	2.85	25 × 50	3.00
			30 × 35	2.80	35 × 30	2.90	30 × 35	3.05
			35 × 25	2.80			30 × 40	3.05
							35 × 30	3.00

Note: I. Ripple Current: (A/rms) 85°C, 120Hz



## CASE SIZE & PERMISSIBLE RIPPLE CURRENT OF STANDARD PRODUCTS

D x L: mm

CAP. (μF)	RATED VOLTAGE WV (SURGE VOLTAGE WV)							
	100 (125) SIZE		160 (200) SIZE		180 (225) SIZE		200 (250) SIZE	
		RIPPLE		RIPPLE		RIPPLE		RIPPLE
1200	22 x 35	2.40	25 x 45	3.15	30 x 40	3.25	25 x 50	3.30
	25 x 30	2.45	30 x 35	3.15	35 x 30	3.30	30 x 40	3.30
			35 x 30	3.20	35 x 35	3.30	30 x 45	3.30
							35 x 30	3.30
							35 x 35	3.30
1500	22 x 40	2.70	30 x 45	3.75	30 x 45	3.85	30 x 45	3.80
	25 x 30	2.75	35 x 30	3.70	35 x 35	3.80	30 x 50	3.80
	30 x 25	2.75	35 x 35	3.70	35 x 40	3.80	35 x 35	3.80
							35 x 40	3.80
1800	22 x 45	3.10	30 x 50	4.20	35 x 40	4.30	35 x 40	4.35
	25 x 35	3.15	35 x 40	4.20	35 x 45	4.30	35 x 45	4.35
	30 x 30	3.15						
	35 x 25	3.15						
2200	22 x 50	3.50	35 x 40	4.60	35 x 45	4.90	35 x 45	4.95
	25 x 40	3.55	35 x 45	4.80	35 x 50	4.90	35 x 50	4.95
	30 x 30	3.55						
	35 x 25	3.60						
2700	25 x 45	4.10	35 x 50	5.45				
	30 x 35	4.05						
	35 x 30	4.05						
3300	25 x 50	4.50						
	30 x 40	4.55						
	35 x 30	4.50						
3900	30 x 45	5.15						
	35 x 35	5.10						
4700	35 x 40	5.75						
5600	35 x 50	6.20						

Note: I. Ripple Current: (A/rms) 85°C, 120Hz

## CASE SIZE & PERMISSIBLE RIPPLE CURRENT OF STANDARD PRODUCTS

D × L: mm

CAP. (μF)	RATED VOLTAGE WV (SURGE VOLTAGE WV)											
	250 (300)		350 (400)		400 (450)		420 (470)		450 (500)		500 (550)	
	SIZE	RIPPLE	SIZE	RIPPLE	SIZE	RIPPLE	SIZE	RIPPLE	SIZE	RIPPLE	SIZE	RIPPLE
47									22 × 25	0.50		
56					22 × 20	0.55			22 × 25	0.65		
68			22 × 20	0.55	22 × 25	0.60			22 × 25	0.67		
					25 × 20	0.60			22 × 30	0.70		
									25 × 25	0.70		
82			22 × 25	0.65	22 × 25	0.80			22 × 30	0.80		
			25 × 20	0.65	25 × 20	0.80			25 × 25	0.80		
100			22 × 30	0.90	22 × 30	0.90			22 × 30	0.85	22 × 40	1.00
			25 × 20	0.90	25 × 25	0.90			22 × 35	0.95	30 × 25	0.90
									25 × 30	0.95		
									30 × 25	0.95		
120	22 × 20	0.78	22 × 30	1.00	22 × 30	0.95	22 × 30	0.95	22 × 30	0.95	30 × 30	1.00
			25 × 25	1.00	22 × 35	1.05			22 × 40	1.05	35 × 25	1.00
					25 × 25	1.05			25 × 30	1.05		
									30 × 25	1.05		
150	22 × 25	0.90	22 × 35	1.15	22 × 35	1.15	22 × 35	1.05	22 × 35	1.05	22 × 50	1.40
			25 × 30	1.15	25 × 30	1.15	25 × 30	1.05	22 × 45	1.20	30 × 35	1.20
			30 × 25	1.15	30 × 25	1.15	30 × 25	1.05	25 × 35	1.20		
									30 × 30	1.20		
180	22 × 25	1.05	22 × 40	1.30	22 × 40	1.20	22 × 40	1.35	25 × 40	1.35	30 × 40	1.40
	25 × 20	1.00	25 × 30	1.25	22 × 45	1.30			30 × 35	1.35	35 × 30	1.30
			30 × 25	1.25	25 × 35	1.30			35 × 25	1.35		
					30 × 30	1.35						
220	22 × 30	1.15	22 × 45	1.45	22 × 50	1.50	22 × 45	1.40	22 × 45	1.40	30 × 45	1.60
	22 × 35	1.15	25 × 35	1.45	25 × 40	1.50	22 × 50	1.55	25 × 50	1.55	35 × 35	1.50
	25 × 25	1.15	30 × 30	1.45	30 × 30	1.50	25 × 40	1.50	30 × 40	1.55		
			35 × 25	1.45	35 × 25	1.50	25 × 45	1.60	35 × 30	1.55		
270	22 × 30	1.30	25 × 40	1.65	22 × 50	1.60	25 × 40	1.50	25 × 50	1.55	30 × 50	1.80
	25 × 25	1.30	30 × 35	1.65	25 × 40	1.65	30 × 40	1.60	30 × 45	1.75	35 × 40	1.70
			35 × 25	1.65	30 × 35	1.65			35 × 35	1.70		
					35 × 30	1.65						

Note: I<sub>r</sub> Ripple Current: (A/rms) 85°C, 120Hz

## CASE SIZE & PERMISSIBLE RIPPLE CURRENT OF STANDARD PRODUCTS

D x L: mm

CAP. (μF)	RATED VOLTAGE WV (SURGE VOLTAGE WV)											
	250 (300)		350 (400)		400 (450)		420 (470)		450 (500)		500 (550)	
	SIZE	RIPPLE	SIZE	RIPPLE	SIZE	RIPPLE	SIZE	RIPPLE	SIZE	RIPPLE	SIZE	RIPPLE
330	22 x 30	1.50	25 x 50	1.80	25 x 45	1.75	25 x 45	1.75	30 x 40	1.75	35 x 45	2.00
	25 x 25	1.50	30 x 40	1.80	25 x 50	1.90	25 x 50	1.85	30 x 50	2.00		
	30 x 25	1.50	35 x 30	1.80	30 x 40	1.90	30 x 40	1.75	35 x 40	2.00		
					35 x 30	1.85	30 x 45	1.90				
390	22 x 35	1.65	30 x 40	2.00	30 x 40	1.95	35 x 45	1.90	30 x 45	2.00	35 x 50	2.30
	25 x 35	1.65	35 x 30	2.00	30 x 45	2.15			35 x 45	2.25		
	30 x 25	1.65			35 x 35	2.10						
470	22 x 40	1.85	30 x 45	2.25	30 x 45	2.20	30 x 45	2.10	30 x 50	2.30		
	25 x 35	1.85	35 x 35	2.25	30 x 50	2.40	30 x 50	2.20	35 x 50	2.50		
	30 x 30	1.90	35 x 40	2.40	35 x 40	2.40						
	35 x 25	1.90										
560	22 x 45	2.10	30 x 50	2.45	30 x 50	2.45	30 x 50	2.30	35 x 50	2.70		
	25 x 40	2.10	35 x 40	2.50	35 x 45	2.70	35 x 45	2.30				
	30 x 30	2.10										
	35 x 25	2.10										
680	25 x 45	2.45	35 x 45	2.90	35 x 50	2.90			35 x 50	2.90		
	30 x 35	2.45										
	35 x 25	2.45							35 x 60	2.90		
820	30 x 45	2.75			35 x 50	3.00						
	35 x 30	2.75			35 x 60	3.20						
1000	30 x 45	3.30										
	35 x 35	3.30										
1200	35 x 40	3.55										
1500	35 x 45	4.05										

Note: I. Ripple Current: (A/rms) 85°C, 120Hz

# LF [ Long Life ]

Snap-in Terminal 85°C 3000 Hours, 100-500V

## Large Can Aluminum Electrolytic Capacitors

### ELECTRICAL CHARACTERISTICS

Operating Temperature Range	-40 to +85°C	-25 to +85°C		
Rated Voltage Range	100V	160 to 450VDC		
Rated Capacitance	180 ~ 5600μF	47 ~ 2200μF		
Capacitance Tolerance	±20% at 120Hz, 20°C			
Leakage Current	I = 0.02CV or 3mA Whichever is smaller. (After 5 Minutes Application of DC Working Voltage at 20°C)			
Dissipation Factor (tanδ)	Rate Voltage (V)	100	160-400	450-500
	D.F. (%)	25	15	20
Low Temperature Stability	Measurement frequency: 120Hz			
Impedance Ratio (Max.)	Rate Voltage (V)	10	160~400	450
	Z(-25°C) / Z(20°C)	2	4	8
	Z(-40°C) / Z(20°C)	5	-	-
Endurance	After the rated voltage and rated ripple current have been applied at 85°C for 2000 hours, the capacitors shall meet the following requirements. (a) Capacitance Change: Within 20% of the Initial Value (b) Dissipation Factor: 200% or Less of Initial Specified Value (c) Leakage Current: Initial Specified Value or Less			
Shelf Life	After having been placed at 85°C without voltage applied for 1000 hours, the capacitors shall meet the same requirements as Endurance.			



### DESCRIPTION

Endurance : 85°C, 3000 Hours

For using in switching power supplies and other industrial / commercial applications

### MULTIPLIER FOR RIPPLE CURRENT

Frequency Coefficient

FREQUENCY (Hz)	50	60	120	1K	10K
6.3~100V	0.88	0.90	1.00	1.15	1.16
160~250V	0.75	0.78	1.00	1.16	1.23
350~450V	0.74	0.76	1.00	1.10	1.15
500V	0.72	0.74	1.00	1.05	1.10

### DIAGRAM OF DIMENSIONS

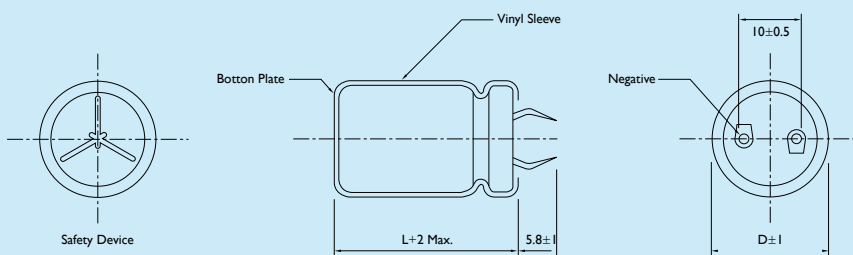

### Location of P.C.B. Holes

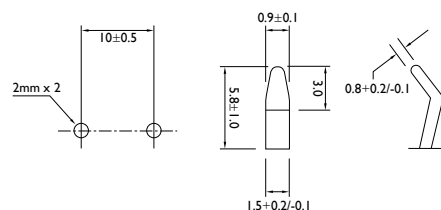

Unit: mm

## CASE SIZE & PERMISSIBLE RIPPLE CURRENT OF STANDARD PRODUCTS

D x L: mm

CAP. (μF)	RATED VOLTAGE WV (SURGE VOLTAGE WV)							
	100 (125) SIZE		160 (200) SIZE		180 (225) SIZE		200 (250) SIZE	
		RIPPLE		RIPPLE		RIPPLE		RIPPLE
180					22 x 20	1.00	22 x 25	0.95
220					22 x 25	1.10	22 x 25	1.00
270			22 x 25	1.15	22 x 25	1.25	22 x 25	1.25
					25 x 20	1.25	22 x 30	1.15
							25 x 25	1.15
330			22 x 25	1.40	22 x 25	1.40	22 x 25	1.45
			25 x 20	1.35	22 x 30	1.40	22 x 30	1.29
					25 x 25	1.40	25 x 25	1.30
390			22 x 30	1.55	22 x 30	1.30	22 x 30	1.60
			25 x 25	1.55	25 x 25	1.60	25 x 25	1.55
			30 x 25	1.50			30 x 25	1.51
470			22 x 30	1.75	22 x 35	1.60	22 x 35	1.80
			25 x 25	1.75	25 x 30	1.60	25 x 30	1.80
			30 x 25	1.70			30 x 25	1.80
560			22 x 30	1.95	22 x 35	2.00	22 x 40	2.00
			25 x 30	1.95	22 x 40	1.89	25 x 35	2.00
			30 x 25	1.90	25 x 30	1.80	30 x 25	2.00
					30 x 25	1.85		
680			22 x 40	2.20	22 x 45	2.10	22 x 45	2.35
			25 x 30	2.20	25 x 35	2.05	25 x 35	2.30
			30 x 25	2.15	30 x 30	2.13	30 x 30	2.30
					35 x 25	2.20	35 x 25	2.30
820	22 x 25	1.85	22 x 45	2.50	22 x 50	2.55	25 x 40	2.60
			25 x 35	2.55	25 x 40	2.55	25 x 45	2.60
			30 x 30	2.50	30 x 30	2.60	30 x 30	2.60
			35 x 25	2.50	30 x 35	2.55	30 x 35	2.60
					35 x 30	2.45	35 x 30	2.60
1000	22 x 30	2.10	22 x 50	2.85	25 x 50	2.67	25 x 45	3.00
	25 x 25	2.10	25 x 40	2.80	30 x 35	2.55	25 x 50	3.00
			30 x 35	2.80	35 x 30	2.63	30 x 35	3.05
			35 x 25	2.80			30 x 40	3.05
						35 x 30	3.00	

Note: I. Ripple Current: (A/rms) 85°C, 120Hz

## CASE SIZE & PERMISSIBLE RIPPLE CURRENT OF STANDARD PRODUCTS

D x L: mm

CAP. (μF)	RATED VOLTAGE WV (SURGE VOLTAGE WV)							
	100 (125) SIZE		160 (200) SIZE		180 (225) SIZE		200 (250) SIZE	
		RIPPLE		RIPPLE		RIPPLE		RIPPLE
1200	22 x 35	2.15	25 x 50	2.78	30 x 40	2.85		
	25 x 30	2.15	30 x 40	2.80			30 x 50	2.90
			35 x 35	2.92	35 x 35	2.93	30 x 45	3.30
							35 x 40	2.90
1500	22 x 40	2.57	30 x 45	3.03	30 x 50	3.10		
	25 x 30	2.45						
	30 x 25	2.52	35 x 40	3.17	35 x 40	3.10	35 x 45	3.11
1800	22 x 45	2.83	30 x 50	3.5			35 x 40	4.35
	25 x 35	2.75	35 x 45	3.67	35 x 45	3.6	35 x 45	4.35
	30 x 30	2.86						
2200	22 x 50	3.17	35 x 50	4.08				
	25 x 40	3.08						
	30 x 30	3.05						
	35 x 25	3.10						
2700	25 x 45	3.45						
	30 x 35	3.45						
	35 x 30	3.55						
3300	25 x 50	3.94						
	30 x 40	3.98						
	35 x 30	3.90						
3900	30 x 45	4.34						
	35 x 35	4.30						
4700	35 x 40	4.75						
5600	35 x 50	5.30						

Note: I. Ripple Current: (A/rms) 85°C, 120Hz

## CASE SIZE & PERMISSIBLE RIPPLE CURRENT OF STANDARD PRODUCTS

D × L: mm

CAP. (μF)	RATED VOLTAGE WV (SURGE VOLTAGE WV)									
	250 (300)		350 (400)		400 (450)		450 (500)		500 (550)	
	SIZE	RIPPLE	SIZE	RIPPLE	SIZE	RIPPLE	SIZE	RIPPLE	SIZE	RIPPLE
47										
56							22 × 25	0.65		
68			22 × 20	0.55	22 × 25	0.65	22 × 25	0.67		
							22 × 30	0.75		
							25 × 25	0.70		
82			22 × 25	0.70	22 × 25	0.75	22 × 30	0.85		
			25 × 20	0.65			25 × 25	0.85		
100			22 × 30	0.80	22 × 30	0.85	22 × 30	0.85	22 × 40	1.00
					25 × 25	0.85	22 × 35	0.90	30 × 25	0.90
							25 × 30	0.90		
120			22 × 30	0.85					30 × 30	1.00
			25 × 25	0.85	22 × 35	0.99	22 × 40	1.10	35 × 25	1.00
					25 × 25	0.93	25 × 35	1.12		
					30 × 25	1.04	30 × 25	1.10		
150			22 × 35	1.11	22 × 40	1.15	22 × 50	1.25	22 × 50	1.40
			25 × 25	1.05	25 × 30	1.10	25 × 40	1.21	30 × 35	1.20
					30 × 25	1.13				
							30 × 30	1.20		
180	22 × 25	1.00	22 × 40	1.16			25 × 45	1.40	30 × 40	1.40
			25 × 35	1.17	22 × 45	1.24	30 × 35	1.39	35 × 30	1.30
			30 × 25	1.15	25 × 35	1.30	35 × 25	1.35		
					30 × 30	1.25				
220	22 × 30	1.15	22 × 45	1.34	22 × 50	1.40			30 × 45	1.60
			25 × 35	1.30	25 × 40	1.36	25 × 50	1.51	35 × 35	1.50
	25 × 25	1.15	30 × 30	1.35	30 × 30	1.35	30 × 40	1.53		
			35 × 25	1.39	35 × 25	1.38	35 × 30	1.50		
270	22 × 30	1.30	25 × 45	1.51	22 × 50	1.60			30 × 50	1.80
	25 × 25	1.30	30 × 35	1.49	25 × 45	1.50	30 × 45	1.72	35 × 40	1.70
			35 × 25	1.49	30 × 35	1.50	35 × 35	1.70		
					35 × 30	1.54				

Note: I. Ripple Current: (A/rms) 85°C, 120Hz

## CASE SIZE & PERMISSIBLE RIPPLE CURRENT OF STANDARD PRODUCTS

D x L: mm

CAP. (μF)	RATED VOLTAGE WV (SURGE VOLTAGE WV)									
	250 (300) SIZE		350 (400) SIZE		400 (450) SIZE		450 (500) SIZE		500 (550) SIZE	
	SIZE	RIPPLE	SIZE	RIPPLE	SIZE	RIPPLE	SIZE	RIPPLE	SIZE	RIPPLE
330	22 x 35	1.45	25 x 50	1.67					35 x 45	2.00
	25 x 30	1.45	30 x 40	1.68	25 x 50	1.70	30 x 50	1.90		
			35 x 30	1.65	30 x 40	1.70	35 x 40	1.90		
					35 x 35	1.77				
390	22 x 40	1.62	30 x 45	1.87			30 x 45	2.00	35 x 50	2.30
	25 x 35	1.63	35 x 35	1.85	30 x 45	1.92	35 x 45	2.10		
	30 x 25	1.60			35 x 35	1.90				
470	22 x 45	1.80	30 x 50	2.10						
	25 x 40	1.84					35 x 50	2.30		
	30 x 30	1.80	35 x 40	2.10	35 x 40	2.10				
	35 x 25	1.85								
560					35 x 50	2.30				
	25 x 40	2.00	35 x 40	2.30						
	30 x 35	2.10								
	35 x 30	2.20								
680	25 x 45	2.21	35 x 50	2.6	35 x 50	2.90				
	22 x 50	2.14								
	30 x 35	2.20								
	35 x 30	2.27								
820	25 x 50	2.32								
	30 x 35	2.22								
	35 x 30	2.30								
1000	30 x 45	2.63								
	35 x 35	2.60								
1200	35 x 40	2.90								
	30 x 50	2.90								
1500	35 x 45	3.11								

Note: I. Ripple Current: (A/rms) 85°C, 120Hz



## CASE SIZE & PERMISSIBLE RIPPLE CURRENT OF STANDARD PRODUCTS

D x L: mm

CAP. ( $\mu$ F)	RATED VOLTAGE WV (SURGE VOLTAGE WV)											
	25 (32)				35 (44)				50 (63)			
	SIZE	RIPPLE CURRENT	DISSIPATION FACTOR	ESR	SIZE	RIPPLE CURRENT	DISSIPATION FACTOR	ESR	SIZE	RIPPLE CURRENT	DISSIPATION FACTOR	ESR
1.0									4 x 5.4	60	0.12	5.00
2.2									4 x 5.4	60	0.12	5.00
3.3									4 x 5.4	60	0.12	5.00
4.7					4 x 5.4	90	0.12	1.93	5 x 5.4	95	0.12	4.00
10	4 x 5.4	90	0.14	1.93	5 x 5.4	160	0.12	1.00	6.3 x 5.4	140	0.12	2.60
22	5 x 5.4	160	0.14	1.00	5 x 5.4	160	0.12	1.00	8 x 6.5	230	0.12	1.30
33	6.3 x 5.4	240	0.14	0.52	6.3 x 5.4	240	0.12	0.52	8 x 10.5	350	0.12	0.50
47	6.3 x 5.4	240	0.14	0.52	6.3 x 7.7	280	0.12	0.34	10 x 10.5	670	0.12	0.34
68	6.3 x 7.7	280	0.14	0.34	6.3 x 7.7	280	0.12	0.34	10 x 10.5	670	0.12	0.34
100	8 x 6.5	300	0.14	0.26	8 x 10.5	600	0.12	0.16	10 x 10.5	670	0.12	0.34
150	8 x 10.5	600	0.14	0.16	10 x 10.5	850	0.12	0.12				
220	8 x 10.5	600	0.14	0.16	10 x 10.5	850	0.12	0.12				
330	10 x 10.5	850	0.14	0.12								

Note: 1. Ripple Current: (mA/rms) 105°C, 100KHz

2. Dissipation Factor: 20°C, 120Hz

3. ESR: 100KHz / 20°C ( $\Omega$  Max.)

# LG [ High Temperature ]

Snap-in Terminal 105°C 2000hrs assured

## Large Can Aluminum Electrolytic Capacitors

### ELECTRICAL CHARACTERISTICS

Operating Temperature Range	-40 to +105°C	-25 to +105°C																								
Rated Voltage Range	6.3 to 100VDC	160 to 450VDC																								
Rated Capacitance Range	560 ~ 82000µF	47 ~ 2200µF																								
Capacitance Tolerance	±20% at 120Hz, 20°C																									
Leakage Current	I = 0.02CV, L = 20m/m, I = 0.03CV or 3mA whichever is smaller. (After 5 Minutes Application of DC Working Voltage at 20°C) I = Leakage Current (µA), C = Nominal Capacitance (µF), V = Rated Voltage (V)																									
Dissipation Factor (tanδ)	<table border="1"> <tr> <td>Rate Voltage (V)</td> <td>6.3</td> <td>10</td> <td>16</td> <td>25</td> <td>35</td> <td>50</td> <td>63-100</td> <td>160-400</td> <td>450</td> </tr> <tr> <td>D.F. (%)</td> <td>60</td> <td>55</td> <td>55</td> <td>45</td> <td>35</td> <td>30</td> <td>25</td> <td>15</td> <td>20</td> </tr> </table>		Rate Voltage (V)	6.3	10	16	25	35	50	63-100	160-400	450	D.F. (%)	60	55	55	45	35	30	25	15	20				
Rate Voltage (V)	6.3	10	16	25	35	50	63-100	160-400	450																	
D.F. (%)	60	55	55	45	35	30	25	15	20																	
Low Temperature Stability	Measurement frequency: 120Hz																									
Impedance Ratio (Max.)	<table border="1"> <tr> <td>Rated Voltage (V)</td> <td>6.3~16</td> <td>25</td> <td>35</td> <td>50~63</td> <td>80~10</td> <td>160~400</td> <td>450</td> </tr> <tr> <td>Z(-25°C) / Z(20°C)</td> <td>4</td> <td>3</td> <td>3</td> <td>2</td> <td>2</td> <td>4</td> <td>8</td> </tr> <tr> <td>Z(-40°C) / Z(20°C)</td> <td>15</td> <td>10</td> <td>8</td> <td>6</td> <td>5</td> <td>-</td> <td>-</td> </tr> </table>		Rated Voltage (V)	6.3~16	25	35	50~63	80~10	160~400	450	Z(-25°C) / Z(20°C)	4	3	3	2	2	4	8	Z(-40°C) / Z(20°C)	15	10	8	6	5	-	-
Rated Voltage (V)	6.3~16	25	35	50~63	80~10	160~400	450																			
Z(-25°C) / Z(20°C)	4	3	3	2	2	4	8																			
Z(-40°C) / Z(20°C)	15	10	8	6	5	-	-																			
Endurance	After the rated voltage and rated ripple current have been applied at 105°C for 2000 hours, the capacitors shall meet the following requirements. (a) Capacitance Change: ≤ ±20% of the Initial Value (b) Dissipation Factor: ≤ 200% of the Initial Specified Value (c) Leakage Current: ≤ the Initial Specified Value																									
Shelf Life	After having been placed at 105°C without voltage applied for 1000 hours, the capacitors shall meet the same requirements as Endurance.																									



### DESCRIPTION

Endurance : 105°C 2000 hours, high temperature than LH.

For Printed Circuit Board High-Performance Aluminum Electrolytic Power Supply Input and Output Filter Capacitors

Ideally suitable for using in switching power supplies and other industrial / commercial applications.

### MULTIPLIER FOR RIPPLE CURRENT

Frequency Coefficient

FREQUENCY (Hz)	50	60	120	1K	10K
6.3~100V	0.88	0.90	1.00	1.15	1.16
160~250V	0.85	0.88	1.00	1.15	1.20
315~450V	0.88	0.90	1.00	1.10	1.15

### DIAGRAM OF DIMENSIONS

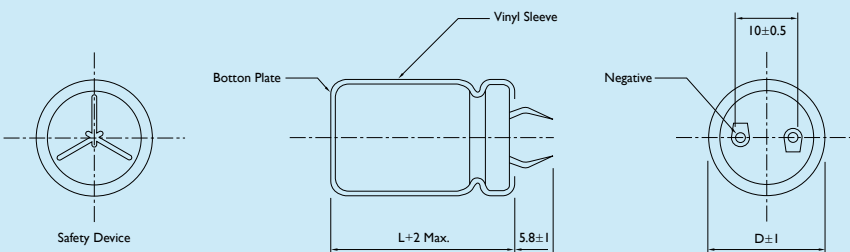

Unit: mm

### Location of P.C.B. Holes

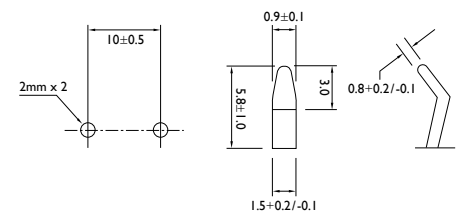

## CASE SIZE & PERMISSIBLE RIPPLE CURRENT OF STANDARD PRODUCTS

D × L: mm

CAP. (μF)	RATED VOLTAGE WV (SURGE VOLTAGE WV)							
	6.3 (8) SIZE		10 (13) SIZE		16 (20) SIZE		25 (32) SIZE	
		RIPPLE		RIPPLE		RIPPLE		RIPPLE
4700							22 × 25	1.50
5600							22 × 30	1.65
							25 × 25	1.65
6800					22 × 25	1.55	22 × 30	1.85
							25 × 25	1.85
8200					22 × 30	1.70	22 × 35	2.10
					25 × 25	1.70	25 × 30	2.10
							30 × 25	2.15
10000			22 × 25	1.55	22 × 30	1.95	22 × 40	2.40
			25 × 25	1.55	25 × 25	1.95	25 × 35	2.40
							30 × 30	2.40
							35 × 25	2.40
12000	22 × 25	1.55	22 × 30	1.75	22 × 35	2.20	22 × 45	2.70
					25 × 30	2.25	25 × 40	2.75
					30 × 25	2.30	30 × 30	2.70
							35 × 25	2.75
15000	22 × 30	1.70	22 × 30	1.90	22 × 40	2.55	25 × 45	3.15
	25 × 25	1.70	25 × 25	1.90	25 × 35	2.60	30 × 35	3.15
					30 × 30	2.60	35 × 30	3.25
					35 × 25	2.65		
18000	22 × 30	1.95	22 × 35	2.20	22 × 45	2.90	25 × 50	3.55
	25 × 25	1.95	25 × 30	2.25	25 × 40	2.90	30 × 40	3.55
					30 × 30	2.90	35 × 35	3.55
					35 × 25	2.95		
22000	22 × 35	2.25	22 × 40	2.50	25 × 45	3.30	30 × 45	4.05
	25 × 30	2.25	25 × 35	2.55	30 × 35	3.30	35 × 35	3.80
	30 × 25	2.25	30 × 25	2.45	35 × 30	3.30		
27000	22 × 40	2.55	22 × 50	2.95	25 × 50	3.80	35 × 45	4.70
	25 × 35	2.55	25 × 40	2.90	30 × 40	3.75		
	30 × 30	2.55	30 × 30	2.85	35 × 30	3.75		
	35 × 25	2.55	35 × 25	2.80				
33000	22 × 45	2.90	25 × 45	3.30	30 × 45	4.30	35 × 50	5.40
	25 × 40	2.95	30 × 35	3.30	35 × 35	4.25		
	30 × 30	2.90	35 × 30	3.30				
	35 × 25	2.95						
39000	25 × 50	3.25	25 × 50	3.70	30 × 50	4.80		
	30 × 35	3.25	30 × 40	3.70	35 × 40	4.80		
	35 × 30	3.30	35 × 30	3.65				
47000	25 × 50	3.70	30 × 45	4.20	35 × 45	5.45		
	30 × 40	3.70	35 × 35	3.80				
56000	30 × 45	4.15	30 × 50	4.65				
	35 × 35	4.10	35 × 40	4.65				
68000	30 × 50	4.70	35 × 50	5.50				
	35 × 40	4.70						
82000	35 × 45	5.30						

Note: I. Ripple Current: (A/rms) 105°C, 120Hz

## CASE SIZE & PERMISSIBLE RIPPLE CURRENT OF STANDARD PRODUCTS

D × L: mm

CAP. (μF)	RATED VOLTAGE WV (SURGE VOLTAGE WV)							
	35 (44) SIZE		50 (63) SIZE		63 (79) SIZE		80 (100) SIZE	
		RIPPLE		RIPPLE		RIPPLE		RIPPLE
820							22 × 25	1.10
1000							22 × 30	1.20
							25 × 25	1.20
1200					22 × 25	1.20	22 × 30	1.40
							25 × 25	1.40
1500					22 × 30	1.30	22 × 35	1.60
					25 × 25	1.30	25 × 30	1.60
							30 × 25	1.65
1800			22 × 25	1.30	22 × 30	1.50	22 × 40	1.80
					25 × 25	1.50	25 × 35	1.85
							30 × 25	1.80
2200			22 × 30	1.55	22 × 35	1.70	22 × 45	2.05
			25 × 25	1.55	25 × 30	1.75	25 × 35	2.00
					30 × 25	1.80	30 × 30	2.05
							35 × 25	2.05
2700			22 × 30	1.70	22 × 40	2.00	25 × 45	2.35
			25 × 25	1.70	25 × 35	2.00	30 × 35	2.35
					30 × 25	1.95	35 × 30	2.35
3300	22 × 25	1.40	22 × 35	1.95	22 × 50	2.30	25 × 50	2.70
			25 × 30	1.85	25 × 40	2.30	30 × 40	2.70
					30 × 30	2.25	35 × 30	2.55
					35 × 25	2.10		
3900	22 × 30	1.55	22 × 40	2.15	25 × 45	2.55	30 × 45	3.00
	25 × 25	1.55	25 × 35	2.20	30 × 35	2.55	35 × 35	3.00
			30 × 25	1.95	35 × 30	2.55		
4700	22 × 35	1.80	22 × 45	2.45	25 × 50	2.85	30 × 50	3.40
	25 × 25	1.80	25 × 40	2.45	30 × 40	2.85	35 × 40	3.40
			30 × 30	2.45	35 × 30	2.80		
			35 × 25	2.50				

Note: I. Ripple Current: (A/rms) 105°C, 120Hz

## CASE SIZE & PERMISSIBLE RIPPLE CURRENT OF STANDARD PRODUCTS

D x L: mm

CAP. (μF)	RATED VOLTAGE WV (SURGE VOLTAGE WV)							
	35 (44) SIZE		50 (63) SIZE		63 (79) SIZE		80 (100) SIZE	
		RIPPLE		RIPPLE		RIPPLE		RIPPLE
5600	22 x 35	19.5	22 x 50	2.75	30 x 45	3.20	35 x 45	3.80
	25 x 30	1.95	25 x 40	2.70	35 x 35	3.20		
	30 x 25	2.00	30 x 35	2.75				
			35 x 30	2.75				
6800	22 x 40	2.20	25 x 50	3.30	30 x 50	3.65	35 x 50	3.90
	25 x 35	2.25	30 x 40	3.30	35 x 40	3.65		
	30 x 30	2.30	35 x 30	3.25				
	35 x 25	2.35						
8200	22 x 50	2.55	30 x 45	3.60	35 x 45	3.90	35 x 60	4.00
	25 x 40	2.50	35 x 35	3.55				
	30 x 30	2.75						
	35 x 25	2.75						
10000	25 x 45	2.85	30 x 50	4.05	35 x 50	4.40		
	30 x 35	2.90	35 x 50	4.05				
	35 x 30	2.95	35 x 40	4.00				
12000	25 x 50	3.25	35 x 45	4.55				
	30 x 40	3.25						
	35 x 30	3.15						
15000	30 x 45	3.70						
	35 x 35	3.65						
18000	35 x 40	4.35						
22000	35 x 50	4.90						

Note: I. Ripple Current: (A/rms) 105°C, 120Hz

## CASE SIZE & PERMISSIBLE RIPPLE CURRENT OF STANDARD PRODUCTS

D × L: mm

CAP. (μF)	RATED VOLTAGE WV (SURGE VOLTAGE WV)							
	100 (125) SIZE		160 (200) SIZE		180 (225) SIZE		200 (250) SIZE	
		RIPPLE		RIPPLE		RIPPLE		RIPPLE
150							22 × 20	0.65
180					22 × 20	0.75	22 × 20	0.70
220			22 × 20	0.80	22 × 25	0.85	22 × 25	0.80
							25 × 20	0.80
270			22 × 25	1.00	22 × 25	0.95	22 × 25	0.85
					25 × 20	0.90	25 × 25	0.85
330			22 × 25	1.20	22 × 25	1.20	22 × 30	1.20
			25 × 20	1.15	22 × 30	1.10	25 × 25	1.20
					25 × 25	1.10		
390			22 × 30	1.30	22 × 30	1.30	22 × 30	1.30
			25 × 25	1.30	25 × 25	1.30	22 × 35	1.30
							25 × 30	1.30
							30 × 25	1.30
470			22 × 30	1.30	22 × 30	1.30	22 × 35	1.40
			22 × 35	1.40	22 × 35	1.35	22 × 40	1.40
			25 × 25	1.40	25 × 30	1.40	25 × 30	1.40
					30 × 25	1.40	30 × 25	1.50
560	22 × 25	1.05	22 × 40	1.50	22 × 40	1.50	22 × 45	1.55
			25 × 30	1.50	25 × 35	1.55	25 × 35	1.55
			30 × 25	1.50	30 × 25	1.50	30 × 30	1.55
680	22 × 25	1.20	22 × 45	1.70	22 × 45	1.70	22 × 50	1.75
			25 × 35	1.70	22 × 50	1.70	25 × 40	1.75
			30 × 25	1.70	25 × 35	1.70	30 × 30	1.75
					25 × 40	1.75	35 × 25	1.70
					30 × 30	1.70		
					35 × 25	1.70		
820	22 × 30	1.30	22 × 50	1.95	22 × 50	1.95	25 × 50	2.05
	25 × 25	1.33	25 × 40	2.00	25 × 40	2.00	30 × 35	2.00
			30 × 30	2.00	25 × 45	2.00	35 × 30	2.05
			35 × 25	1.90	30 × 35	2.00		
					35 × 25	1.90		

Note: I<sub>r</sub> Ripple Current: (A/rms) 105°C, 120Hz

## CASE SIZE & PERMISSIBLE RIPPLE CURRENT OF STANDARD PRODUCTS

D x L: mm

CAP. (μF)	RATED VOLTAGE WV (SURGE VOLTAGE WV)							
	100 (125) SIZE		160 (200) SIZE		180 (225) SIZE		200 (250) SIZE	
		RIPPLE		RIPPLE		RIPPLE		RIPPLE
1000	22 x 35	1.50	25 x 45	2.20	25 x 45	2.20	30 x 40	2.30
	25 x 30	1.50	30 x 35	2.20	25 x 50	2.20	30 x 45	2.30
			35 x 30	2.20	30 x 35	2.25	35 x 30	2.30
					30 x 40	2.25	35 x 35	2.30
					35 x 30	2.25		
1200	22 x 40	1.70	25 x 50	2.45	25 x 50	2.45	30 x 50	2.60
	25 x 35	1.70	30 x 40	2.45	30 x 40	2.45	35 x 40	2.65
	30 x 25	1.70	35 x 30	2.45	30 x 45	2.50		
					35 x 35	2.50		
1500	22 x 45	1.95	30 x 45	2.80	30 x 45	2.80	35 x 45	3.10
	25 x 40	2.00	35 x 35	2.80	30 x 50	2.90		
	30 x 30	1.95			35 x 40	2.90		
	35 x 25	2.00						
1800	25 x 45	2.20	30 x 50	3.30	30 x 50	3.30	35 x 50	3.15
	30 x 35	2.50	35 x 45	3.30	35 x 50	3.30		
	35 x 30	2.45						
2200	25 x 50	2.55	35 x 50	3.75	35 x 50	3.60	35 x 50	4.80
	30 x 40	2.70						
	35 x 30	2.55						
2700	30 x 45	2.90						
	35 x 35	2.85						
3300	30 x 50	3.25						
	35 x 40	3.25						
3900	35 x 45	3.70						
4700	35 x 50	3.80						

Note: I. Ripple Current: (A/rms) 105°C, 120Hz

## CASE SIZE & PERMISSIBLE RIPPLE CURRENT OF STANDARD PRODUCTS

D x L: mm

CAP. (μF)	RATED VOLTAGE WV (SURGE VOLTAGE WV)											
	250 (300) SIZE      RIPPLE		350 (400) SIZE      RIPPLE		400 (450) SIZE      RIPPLE		420 (470) SIZE      RIPPLE		450 (500) SIZE      RIPPLE			
47					22 x 20	0.35			22 x 25	0.38		
56			22 x 20	0.40	22 x 20	0.40			22 x 25	0.40		
68			22 x 25	0.45	22 x 25	0.50			22 x 30	0.50		
					25 x 20	0.50			25 x 25	0.50		
82			22 x 25	0.55	22 x 25	0.52			22 x 30	0.52		
					25 x 20	0.50	22 x 30	0.60		22 x 35	0.55	
					25 x 25	0.65			25 x 30	0.55		
									30 x 25	0.55		
100	22 x 25	0.56	22 x 30	0.70	22 x 30	0.60			22 x 30	0.55		
							22 x 35	0.65		22 x 40	0.65	
							25 x 25	0.65		25 x 30	0.60	
							25 x 30	0.65		30 x 25	0.65	
120	22 x 20	0.60	22 x 35	0.75	22 x 35	0.70			22 x 35	0.60		
					25 x 30	0.70			22 x 45	0.70		
					30 x 25	0.75	30 x 25	0.75			25 x 35	0.70
									30 x 30	0.70		
									35 x 25	0.70		
150	22 x 25	0.65	22 x 40	0.80	22 x 35	0.72	22 x 35	0.58	22 x 40	0.68		
					25 x 30	0.80	22 x 40	0.80	22 x 40	0.65	22 x 50	0.80
					30 x 25	0.85	25 x 30	0.85	25 x 30	0.70	25 x 40	0.80
							25 x 35	0.85			30 x 30	0.75
							30 x 30	0.85			35 x 25	0.75
				35 x 25	0.80							
180	22 x 25	0.80	22 x 45	0.90	22 x 40	0.81	22 x 40	0.68	22 x 45	0.75		
							22 x 50	0.95	25 x 35	0.68	25 x 45	0.85
	25 x 20	0.75	25 x 35	0.90	25 x 40	0.95			30 x 35	0.85		
							30 x 30	0.90			35 x 30	0.85
220	22 x 30	0.95	22 x 50	1.05	25 x 45	1.05	25 x 40	0.85	22 x 50	0.85		
							30 x 30	1.05	25 x 45	0.95	25 x 50	1.00
	25 x 25	0.95	25 x 40	1.05	30 x 30	1.05	30 x 40	0.95	30 x 40	1.00		
							30 x 35	1.05			35 x 30	1.00
		35 x 25	1.05	35 x 30	1.10							

Note: I. Ripple Current: (A/rms) 105°C, 120Hz



## CASE SIZE & PERMISSIBLE RIPPLE CURRENT OF STANDARD PRODUCTS

D × L: mm

CAP. (μF)	RATED VOLTAGE WV (SURGE VOLTAGE WV)											
	250 (300)		350 (400)		400 (450)		420 (470)		450 (500)		500 (550)	
	SIZE	RIPPLE	SIZE	RIPPLE	SIZE	RIPPLE	SIZE	RIPPLE	SIZE	RIPPLE	SIZE	RIPPLE
270	22 × 35	1.15	25 × 45	1.20	22 × 45	1.10	25 × 45	1.05	25 × 50	1.05	3.5 × 40	1.42
	25 × 30	1.15	30 × 35	1.20	25 × 50	1.20	30 × 40	1.05	30 × 45	1.15		
	30 × 25	1.15	35 × 30	1.20	30 × 40	1.20	35 × 30	1.05	35 × 35	1.15		
					35 × 35	1.20						
330	22 × 40	1.25	30 × 40	1.35	25 × 50	1.25	25 × 50	1.15	30 × 45	1.25	3.5 × 45	1.6
	25 × 30	1.20	30 × 45	1.35	30 × 45	1.40	30 × 40	1.15	30 × 50	1.40		
	30 × 25	1.25	35 × 35	1.35	35 × 35	1.35	35 × 35	1.15	35 × 40	1.40		
390	22 × 45	1.50	30 × 45	1.50	30 × 45	1.42	30 × 45	1.25	30 × 50	1.40	3.5 × 50	1.78
	25 × 35	1.50	35 × 35	1.50	30 × 50	1.55			35 × 45	1.55		
	30 × 30	1.50			35 × 40	1.55						
470	22 × 50	1.55	35 × 40	1.70	30 × 45	1.45	30 × 50	1.40	35 × 40	1.47	3.5 × 60	2.03
	25 × 40	1.55			30 × 50	1.75	35 × 40	1.35	35 × 45	1.68		
	30 × 30	1.55			35 × 40	1.65			35 × 50	1.70		
	35 × 25	1.55			35 × 45	1.75						
					35 × 50	1.75						
560	25 × 45	1.80	35 × 45	1.90	30 × 60	1.90	35 × 45	1.65	35 × 50	1.80		
	30 × 35	1.80			35 × 45	1.80			35 × 60	2.10		
	35 × 30	1.80			35 × 50	1.90						
680	25 × 50	1.95	35 × 50	2.10	35 × 50	2.10						
	30 × 40	2.00			35 × 60	2.15						
	35 × 35	2.00										
820	30 × 45	2.15										
	35 × 35	2.10										
1000	30 × 45	2.10										
	35 × 40	2.30										
1500	35 × 50	3.63										

Note: I. Ripple Current: (A/rms) 105°C, 120Hz

# LV [ Long Life and High Ripple Current ]

Snap-in Terminal 105°C 3000 Hours, 10-500V

## Large Can Aluminum Electrolytic Capacitors



### ELECTRICAL CHARACTERISTICS

Operating Temperature Range	-40 to +105°C	-25 to +105°C																										
Rated Voltage Range	10 to 100VDC	160 to 500VDC																										
Rated Capacitance Range	560 ~ 68000μF	270 ~ 2200μF																										
Capacitance Tolerance	±20% at 120Hz, 20°C																											
Leakage Current	$I \leq 0.02CV$ or 3mA whichever is smaller (After Rated Voltage Applied for 5 Minutes) $I$ = Leakage Current (μA), $C$ = Nominal Capacitance (μF), $V$ = Rated Voltage (V)																											
Dissipation Factor (tanδ) (20°C, 120Hz)	<table border="1"> <tr> <td>Rate Voltage (V)</td> <td>10</td> <td>16</td> <td>25</td> <td>35</td> <td>50</td> <td>63</td> <td>80</td> <td>100</td> <td>160</td> <td>180~400</td> <td>450</td> <td>500</td> </tr> <tr> <td>D.F (%)</td> <td>55</td> <td>55</td> <td>45</td> <td>40</td> <td>35</td> <td>30</td> <td>25</td> <td>25</td> <td>15</td> <td>15</td> <td>25</td> <td>25</td> </tr> </table> Dissipation Factor (tan δ) shall not exceed the values showed as above of standard rating		Rate Voltage (V)	10	16	25	35	50	63	80	100	160	180~400	450	500	D.F (%)	55	55	45	40	35	30	25	25	15	15	25	25
Rate Voltage (V)	10	16	25	35	50	63	80	100	160	180~400	450	500																
D.F (%)	55	55	45	40	35	30	25	25	15	15	25	25																
Endurance	After the rated voltage has been applied at 105°C for 3000 hours, the capacitors shall meet the following requirements. (a) Capacitance Change : Within ±20% of the Initial Value (b) Dissipation Factor : Not Exceeding 200% of the Specified Value (c) Leakage current : Not Exceeding the Specified Value																											
Shelf Life	After having been placed at 105°C without voltage applied for 1000 hours, the capacitors shall meet the same requirements as Endurance.																											



### DESCRIPTION

Features : 105°C 3000 hours, Longer life than LG, Snap-in terminal, High ripple current.

Recommended Applications : Smoothing circuit, TV/ Monitor, Adapter, SMPS.

### MULTIPLIER FOR RIPPLE CURRENT

Frequency Coefficient				
<b>FREQUENCY (Hz)</b>	<b>50</b>	<b>60</b>	<b>120</b>	<b>400</b>
<b>COEFFICIENT</b>	0.8	0.85	1.0	1.14
<b>FREQUENCY (Hz)</b>	<b>1K</b>	<b>2.4K</b>	<b>5K</b>	<b>10K</b>
<b>COEFFICIENT</b>	1.23	1.3	1.36	1.4

### FEATURES

- 105°C 3,000 hours assured
- RoHS compliance

### DIAGRAM OF DIMENSIONS

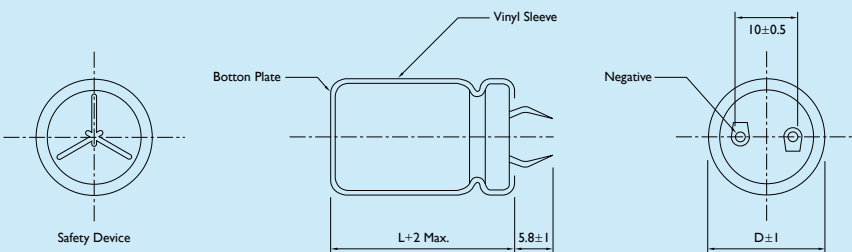

Unit: mm

### Location of P.C.B. Holes

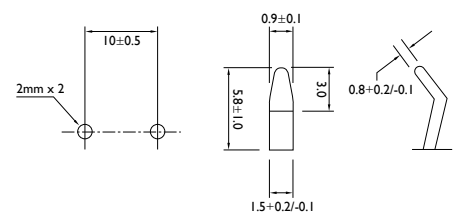

## CASE SIZE & PERMISSIBLE RIPPLE CURRENT OF STANDARD PRODUCTS

D x L: mm

CAP. (μF)	RATED VOLTAGE WV (SURGE VOLTAGE WV)											
	10 (13)		16 (20)		25 (32)		35 (44)		50 (63)		63 (79)	
	SIZE	RIPPLE	SIZE	RIPPLE	SIZE	RIPPLE	SIZE	RIPPLE	SIZE	RIPPLE	SIZE	RIPPLE
1200											22 x 25	1.25
1500									22 x 25	1.25	22 x 30	1.45
											25 x 25	1.45
1800									22 x 30	1.45	22 x 35	1.60
											25 x 30	1.60
2200									22 x 30	1.60	22 x 40	1.89
									25 x 25	1.60	25 x 30	1.80
											30 x 25	1.85
2700							22 x 25	1.45	22 x 35	1.80	22 x 45	2.06
									25 x 30	1.80	25 x 35	2.00
											30 x 30	2.08
3300							22 x 30	1.60	22 x 40	2.05	25 x 40	2.32
									25 x 30	1.95	30 x 30	2.30
									30 x 25	2.01	35 x 25	2.35
3900					22 x 25	1.50	22 x 30	1.80	22 x 45	2.27	25 x 45	2.55
									25 x 35	2.20	30 x 35	2.55
									30 x 30	2.29	35 x 30	2.63
4700					22 x 30	1.80	22 x 35	2.23	22 x 50	2.50	25 x 50	2.83
							25 x 25	2.10	25 x 40	2.42	30 x 40	2.86
									30 x 30	2.40	35 x 30	2.80
									35 x 25	2.45		
5600					22 x 30	1.95	22 x 40	2.41	25 x 45	2.70	30 x 45	3.18
					25 x 25	1.95	25 x 30	2.30	30 x 35	2.70	35 x 35	3.15
							30 x 25	2.37	35 x 30	2.78		
6800			22 x 25	1.80	22 x 35	2.20	22 x 45	2.68	30 x 40	3.06	30 x 50	3.50
					25 x 30	2.20	25 x 35	2.60	35 x 30	3.00	35 x 40	3.50
							30 x 30	2.70				
8200			22 x 30	2.05	22 x 40	2.47	22 x 50	3.02	30 x 45	3.38	35 x 45	3.90
			25 x 25	2.05	25 x 35	2.50	25 x 40	2.93	35 x 35	3.35		
					30 x 25	2.45	30 x 30	2.90				
							35 x 25	2.96				

Note: I. Ripple Current: (A/rms) 105°C, 120Hz

## CASE SIZE & PERMISSIBLE RIPPLE CURRENT OF STANDARD PRODUCTS

D x L: mm

CAP. (μF)	RATED VOLTAGE WV (SURGE VOLTAGE WV)											
	10 (13)		16 (20)		25 (32)		35 (44)		50 (63)		63 (79)	
	SIZE	RIPPLE	SIZE	RIPPLE	SIZE	RIPPLE	SIZE	RIPPLE	SIZE	RIPPLE	SIZE	RIPPLE
10000	22 x 25	1.80	22 x 35	2.45	22 x 45	2.75	25 x 45	3.20	30 x 50	3.50		
			25 x 30	2.45	25 x 40	2.80	30 x 35	3.20	35 x 40	3.70		
			30 x 30	2.75	35 x 30	3.30						
12000	22 x 30	2.05	22 x 40	2.73	22 x 50	3.13	25 x 50	3.64	35 x 50	4.20		
			25 x 25	2.05	25 x 30	2.60	25 x 45	3.22	30 x 40	3.67		
	25 x 25	2.05	30 x 25	2.68	30 x 35	3.19	35 x 30	3.60				
			35 x 25	3.10								
15000	22 x 35	2.45	22 x 45	2.99	25 x 50	3.43	30 x 45	4.04				
	25 x 30	2.45	25 x 35	2.90	30 x 40	3.47	35 x 35	4.00				
	30 x 25	2.55	30 x 30	3.02	35 x 30	3.40						
18000	22 x 40	2.94	22 x 50	3.43	30 x 45	3.94	35 x 40	4.60				
	25 x 30	2.80	25 x 40	3.33	35 x 35	3.90						
	30 x 30	3.11	30 x 30	3.30								
			35 x 25	3.37								
22000	22 x 45	3.24	25 x 45	3.70	30 x 50	4.30	35 x 50	5.10				
	25 x 35	3.15	30 x 35	3.70	35 x 40	4.30						
	30 x 30	3.28	35 x 30	3.81								
	35 x 25	3.37										
27000	25 x 40	3.50	30 x 40	4.15	35 x 45	4.85						
	30 x 35	3.67	35 x 35	4.27								
	35 x 30	3.78										
33000	25 x 45	4.00	30 x 50	4.65								
	30 x 40	4.20	35 x 40	4.65								
	35 x 30	4.08										
39000	25 x 50	4.45	35 x 45	5.25								
	30 x 45	4.67										
	35 x 35	4.63										
47000	35 x 40	4.90	35 x 50	5.80								
56000	35 x 45	5.50										
68000	35 x 50	6.05										

Note: I<sub>r</sub> Ripple Current: (A/rms) 105°C, 120Hz

## CASE SIZE & PERMISSIBLE RIPPLE CURRENT OF STANDARD PRODUCTS

D x L: mm

CAP. (μF)	RATED VOLTAGE WV (SURGE VOLTAGE WV)									
	80 (100) SIZE		100 (125) SIZE		160 (200) SIZE		180 (225) SIZE		200 (250) SIZE	
		RIPPLE		RIPPLE		RIPPLE		RIPPLE		RIPPLE
220									22 x 25	0.85
270					22 x 25	0.85	22 x 25	0.85	22 x 30	1.00
330					22 x 30	1.00	22 x 30	1.10	22 x 30	1.15
									25 x 25	1.15
390					22 x 30	1.15	22 x 35	1.32	22 x 35	1.30
					25 x 25	1.15	25 x 25	1.25	25 x 30	1.30
470					22 x 35	1.30	22 x 40	1.47	22 x 40	1.52
					25 x 30	1.30	25 x 30	1.40	25 x 35	1.54
									30 x 25	1.49
560			22 x 25	1.20	22 x 40	1.57	22 x 45	1.70	22 x 45	1.70
					25 x 30	1.50	25 x 35	1.63	25 x 35	1.65
					30 x 25	1.54	30 x 25	1.60	30 x 30	1.72
680			22 x 30	1.35	22 x 45	1.75	22 x 50	1.87	25 x 45	1.97
					25 x 35	1.70	25 x 40	1.82	30 x 35	1.97
					30 x 30	1.77	30 x 30	1.80	35 x 30	2.02
							35 x 25	1.84		
820	22 x 25	1.20	22 x 30	1.50	22 x 50	2.03	25 x 45	2.05	25 x 45	2.20
			25 x 25	1.50	25 x 40	1.97	30 x 35	2.05	30 x 35	2.10
					30 x 30	1.95	35 x 30	2.11	35 x 30	2.16
					35 x 25	1.99				
1000	22 x 30	1.35	22 x 35	1.70	25 x 45	2.15	25 x 50	2.27	30 x 45	2.32
			25 x 30	1.70	30 x 35	2.15	30 x 40	2.29	35 x 35	2.30
					35 x 30	2.21	35 x 30	2.25		
1200	22 x 35	1.59	22 x 40	1.97	30 x 40	2.45	30 x 45	2.57	30 x 50	2.75
	25 x 25	1.50	25 x 35	1.99	35 x 35	2.52	35 x 35	2.55	35 x 40	2.75
			30 x 25	1.95						
1500	22 x 40	1.78	22 x 45	2.15	30 x 50	2.75	35 x 40	2.85	35 x 45	2.90
	25 x 30	1.70	25 x 40	2.19	35 x 40	2.75				
	30 x 25	1.75	30 x 30	2.15						
			35 x 25	2.21						

Note: I. Ripple Current: (A/rms) 105°C, 120Hz

## CASE SIZE & PERMISSIBLE RIPPLE CURRENT OF STANDARD PRODUCTS

D × L: mm

CAP. (μF)	RATED VOLTAGE WV (SURGE VOLTAGE WV)									
	80 (100) SIZE		100 (125) SIZE		160 (200) SIZE		180 (225) SIZE		200 (250) SIZE	
		RIPPLE		RIPPLE		RIPPLE		RIPPLE		RIPPLE
1800	22 × 45	2.01	25 × 45	2.45	35 × 45	3.00	35 × 50	3.10		
	25 × 35	1.95	30 × 35	2.45						
	30 × 30	2.03	35 × 30	2.52						
2200	25 × 40	2.17	25 × 50	2.75	35 × 50	3.50				
	30 × 30	2.15	30 × 40	2.75						
	35 × 25	2.19	35 × 35	2.86						
2700	25 × 45	2.45	30 × 45	3.08						
	30 × 35	2.45	35 × 35	3.05						
	35 × 30	2.52								
3300	30 × 40	2.75	30 × 50	3.45						
	35 × 35	2.83	35 × 40	3.45						
3900	30 × 45	3.13	35 × 45	3.90						
	35 × 35	3.10								
4700	35 × 40	3.40	35 × 45	3.90						
			35 × 50	4.30						
5600	35 × 50	3.80								

Note: I<sub>r</sub> Ripple Current: (A/rms) 105°C, 120Hz

## CASE SIZE & PERMISSIBLE RIPPLE CURRENT OF STANDARD PRODUCTS

D × L: mm

CAP. (μF)	RATED VOLTAGE WV (SURGE VOLTAGE WV)											
	250 (300)		315 (365)		350 (400)		400 (450)		450 (500)		500 (550)	
	SIZE	RIPPLE	SIZE	RIPPLE	SIZE	RIPPLE	SIZE	RIPPLE	SIZE	RIPPLE	SIZE	RIPPLE
56									22 × 25	0.55		
68							22 × 25	0.55	22 × 30	0.65		
82			22 × 25	0.55	22 × 25	0.60	22 × 30	0.65	22 × 35	0.80	22 × 35	0.68
							25 × 25	0.65	25 × 25	0.75	25 × 35	0.73
100			22 × 30	0.65	22 × 30	0.70	22 × 35	0.79	22 × 40	0.89	22 × 40	0.79
					25 × 25	0.70	25 × 25	0.75	25 × 30	0.85	25 × 40	0.85
									30 × 25	0.85	30 × 35	1.2
120			22 × 30	0.75	22 × 35	0.80	22 × 40	0.89	22 × 45	0.95	22 × 45	0.91
			25 × 25	0.75	25 × 30	0.80	25 × 30	0.85	25 × 35	0.92	25 × 45	0.98
							30 × 25	0.87	30 × 25	0.90		
150	22 × 25	0.75	22 × 35	0.80	22 × 40	0.86	22 × 40	0.85	22 × 50	1.14	22 × 50	1.07
			25 × 30	0.80	25 × 35	0.87	22 × 45	0.93	25 × 40	1.11	25 × 55	1.2
					30 × 25	0.85	25 × 35	0.90	30 × 30	1.10		
							30 × 30	0.94				
							35 × 25	0.96				
180	22 × 30	0.85	22 × 40	1.01	22 × 45	1.05	22 × 50	1.14	25 × 45	1.25		
			25 × 35	1.02	25 × 40	1.07	25 × 40	1.11	30 × 35	1.24		
			30 × 25	1.00	30 × 30	1.05	30 × 30	1.10	35 × 25	1.20		
							35 × 25	1.12				
220	22 × 30	1.00	22 × 45	1.10	22 × 50	1.16	25 × 45	1.20	25 × 50	1.36		
	25 × 25	1.00	25 × 40	1.12	25 × 45	1.20	30 × 35	1.20	30 × 40	1.38	30 × 40	1.4
			30 × 30	1.10	30 × 35	1.18	35 × 30	1.24	35 × 30	1.35		
					35 × 25	1.15						
270	22 × 35	1.22	25 × 45	1.25	25 × 50	1.31	25 × 50	1.36	30 × 45	1.51		
	25 × 25	1.15	30 × 35	1.25	30 × 40	1.33	30 × 40	1.38	35 × 35	1.50	35 × 35	1.61
					35 × 30	1.30	35 × 30	1.35				
330	22 × 40	1.36	25 × 50	1.53	30 × 45	1.46	30 × 45	1.51	30 × 45	1.50		
	25 × 30	1.30	30 × 40	1.53	35 × 35	1.45	35 × 35	1.50	30 × 50	1.70	35 × 45	2.15
			35 × 30	1.50					35 × 40	1.70	35 × 40	1.88

Note: I. Ripple Current: (A/rms) 105°C, 120Hz

## CASE SIZE & PERMISSIBLE RIPPLE CURRENT OF STANDARD PRODUCTS

D x L: mm

CAP. (μF)	RATED VOLTAGE WV (SURGE VOLTAGE WV)											
	250 (300)		315 (365)		350 (400)		400 (450)		450 (500)		500 (550)	
	SIZE	RIPPLE	SIZE	RIPPLE	SIZE	RIPPLE	SIZE	RIPPLE	SIZE	RIPPLE	SIZE	RIPPLE
390	22 x 45	1.54	30 x 45	1.71	30 x 50	1.65	30 x 50	1.70	35 x 45	1.90	35 x 45	2.15
	25 x 35	1.48	35 x 30	1.60	35 x 40	1.65	35 x 40	1.70				
	30 x 25	1.45										
	35 x 25	1.59										
470	22 x 50	1.78	30 x 50	1.85	35 x 45	1.85	35 x 40	1.70	35 x 50	2.10		
	25 x 40	1.75	35 x 35	1.75			35 x 45	1.90				
	30 x 30	1.72										
	35 x 30	1.88										
560	25 x 40	1.80	35 x 40	2.00	35 x 50	2.10	35 x 50	1.90				
	30 x 35	1.89										
	35 x 30	1.94										
680	25 x 50	2.10	35 x 45	2.20	35 x 50	2.30	35 x 50	2.10				
	30 x 40	2.10										
	35 x 35	2.18										
820	30 x 45	2.30										
	35 x 40	2.39										
1000	30 x 50	2.55										
	35 x 40	2.40										
	35 x 45	2.65										
1200	35 x 50	2.90										

Note: I. Ripple Current: (A/rms) 105°C, 120Hz



# Large Can Aluminum Electrolytic Capacitors

# LC [ High Temperature and Long Life ]

Snap-in Terminal 105°C 5000 Hours, High Ripple Current



## DESCRIPTION

Long life, High ripple current

Applications: Smoothing circuit, TV/Monitor, Adapter, SMPS

### MULTIPLIER FOR RIPPLE CURRENT

Frequency Coefficient

<b>FREQUENCY (Hz)</b>	50	60	120	400
<b>COEFFICIENT</b>	0.80	0.85	1.00	1.14
<b>FREQUENCY (Hz)</b>	1K	2.4K	5K	10K
<b>COEFFICIENT</b>	1.23	1.30	1.36	1.40

## FEATURES

105°C 5000 hours assured

Suitable for high voltage circuits

RoHS compliance

## DIAGRAM OF DIMENSIONS

Unit: mm

Location of P.C.B. Holes

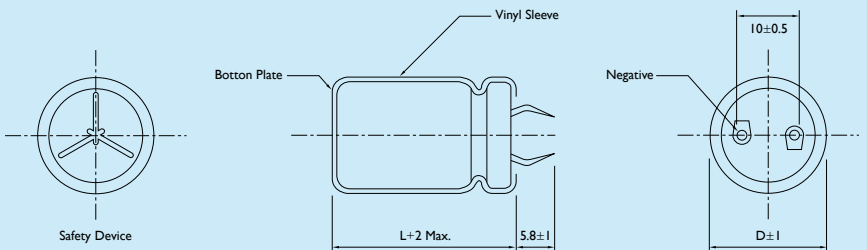
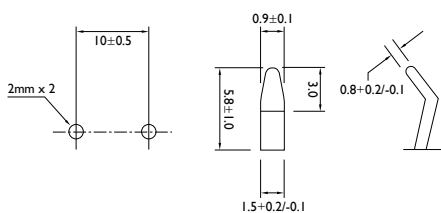

## ELECTRICAL CHARACTERISTICS

Operating Temperature Range	-25 ~ +105°C		
Rated Voltage Range	160 ~ 500VDC		
Rated Capacitance Range	270 ~ 2200μF		
Capacitance Tolerance	±20% at 120Hz, 20°C		
Leakage Current	Leakage Current (Max.) (20°C) : I = 0.02CV or 3μA whichever is greater. (After Rated Voltage Applied for 5 Minutes)		
Dissipation Factor (Max. tanδ) (20°C, 120Hz)	Rated Voltage (V)	160~400	450~500V
	D.F (%)	15	25
Endurance	After the rated voltage has been applied at 105°C for 5000 hours, the capacitors shall meet the following requirements. (a) Capacitance Change : Within ±20% of Initial Value (b) Dissipation Factor: Not Exceeding 200% of the Specified Value (c) Leakage Current: Not Exceeding the Specified Value		
Shelf Life	After having been placed at 105°C without voltage applied for 1000 hours, the capacitors shall meet the same requirements as Endurance.		

## CASE SIZE & PERMISSIBLE RIPPLE CURRENT OF STANDARD PRODUCTS

D × L: mm

CAP. (μF)	RATED VOLTAGE WV (SURGE VOLTAGE WV)							
	160 (200) SIZE		180 (225) SIZE		200 (250) SIZE		250 (300) SIZE	
	SIZE	RIPPLE	SIZE	RIPPLE	SIZE	RIPPLE	SIZE	RIPPLE
150							22 × 25	0.75
180							22 × 30	0.85
220					22 × 25	0.85	22 × 30	1.00
							25 × 25	1.00
270	22 × 25	0.85	22 × 25	0.85	22 × 30	1.00	22 × 35	1.22
							25 × 25	1.15
330	22 × 30	1.00	22 × 30	1.10	22 × 30	1.15	22 × 40	1.36
					25 × 25	1.15	25 × 30	1.30
390	22 × 30	1.15	22 × 35	1.32	22 × 35	1.30	22 × 45	1.54
	25 × 25	1.15	25 × 25	1.25	25 × 30	1.30	25 × 35	1.48
							30 × 25	1.45
							35 × 25	1.59
470	22 × 35	1.30	22 × 40	1.47	22 × 40	1.52	22 × 50	1.78
	25 × 30	1.30	25 × 30	1.40	25 × 35	1.54	25 × 40	1.75
					30 × 25	1.49	30 × 30	1.72
							35 × 30	1.88
560	22 × 40	1.57	22 × 45	1.70	22 × 45	1.70	25 × 40	1.80
	25 × 30	1.50	25 × 35	1.63	25 × 35	1.65	30 × 35	1.89
	30 × 25	1.54	30 × 25	1.60	30 × 30	1.72	35 × 30	1.94
680	22 × 45	1.75	22 × 50	1.87	25 × 45	1.97	25 × 50	2.10
	25 × 35	1.70	25 × 40	1.82	30 × 35	1.97	30 × 40	2.10
	30 × 30	1.77	30 × 30	1.80	35 × 30	2.02	35 × 35	2.18
			35 × 25	1.84				
820	22 × 50	2.03	25 × 45	2.05	25 × 45	2.20	30 × 45	2.30
	25 × 40	1.97	30 × 35	2.05	30 × 35	2.10	35 × 40	2.39
	30 × 30	1.95	35 × 30	2.11	35 × 30	2.16		
	35 × 25	1.99						
1000	25 × 45	2.15	25 × 50	2.27	30 × 45	2.32	30 × 50	2.55
	30 × 35	2.15	30 × 40	2.29	35 × 35	2.30	35 × 45	2.65
	35 × 30	2.21	35 × 30	2.25				
1200	30 × 40	2.45	30 × 45	2.57	30 × 50	2.75	35 × 50	2.90
	35 × 35	2.52	35 × 35	2.55	35 × 40	2.75		
1500	30 × 50	2.75	35 × 40	2.85	35 × 45	2.90		
	35 × 40	2.75						
1800	35 × 45	3.00	35 × 50	3.10				
2200	35 × 50	3.50						

Note: 1. Ripple Current: (A/rms) 105°C, 120Hz

2. Dissipation Factor: 20°C, 120Hz

3. ESR: 120Hz / 20°C (Ω Max.)

## CASE SIZE & PERMISSIBLE RIPPLE CURRENT OF STANDARD PRODUCTS

D x L: mm

CAP. (μF)	RATED VOLTAGE WV (SURGE VOLTAGE WV)											
	315 (365)		350 (400)		400 (450)		420 (470)		450 (500)		500 (550)	
	SIZE	RIPPLE	SIZE	RIPPLE	SIZE	RIPPLE	SIZE	RIPPLE	SIZE	RIPPLE	SIZE	RIPPLE
56									22 x 25	0.55		
68					22 x 25	0.55	25 x 25	0.36	22 x 30	0.65		
82	22 x 25	0.55	22 x 25	0.60	22 x 30	0.65			22 x 35	0.80		
					25 x 25	0.65			25 x 25	0.75		
100	22 x 30	0.65	22 x 30	0.70	22 x 35	0.79	22 x 30	0.43	22 x 40	0.89	30 x 25	0.82
			25 x 25	0.70	25 x 25	0.75	25 x 25	0.43	25 x 30	0.85		
120	22 x 30	0.75	22 x 35	0.80	22 x 40	0.89	22 x 35	0.50	22 x 45	0.95	30 x 30	0.91
	25 x 25	0.75	25 x 30	0.80	25 x 30	0.85	35 x 25	0.59	25 x 35	0.92	35 x 25	0.88
					30 x 25	0.87			30 x 25	0.90		
150	22 x 35	0.80	22 x 40	0.86	22 x 45	0.93	22 x 40	0.61	22 x 50	1.14	30 x 35	1.04
	25 x 30	0.80	25 x 35	0.87	25 x 35	0.90	25 x 30	0.58	25 x 40	1.11		
			30 x 25	0.85	30 x 30	0.94	30 x 25	0.58	30 x 30	1.10		
					35 x 25	0.96						
180	22 x 40	1.01	22 x 45	1.05	22 x 50	1.14	22 x 45	0.70	25 x 45	1.25	30 x 40	1.17
	25 x 35	1.02	25 x 40	1.07	25 x 40	1.11	25 x 35	0.68	30 x 35	1.24	35 x 30	1.10
	30 x 25	1.00	30 x 30	1.05	30 x 30	1.10	30 x 30	0.71	35 x 25	1.20		
					35 x 25	1.12						
220	22 x 45	1.10	22 x 50	1.16	25 x 45	1.20	22 x 50	0.82	25 x 50	1.36	30 x 45	1.33
	25 x 40	1.12	25 x 45	1.20	30 x 35	1.20	25 x 40	0.80	30 x 40	1.38	35 x 35	1.23
	30 x 30	1.10	30 x 35	1.18	35 x 30	1.24	30 x 35	0.84	35 x 30	1.35		
			35 x 25	1.15			35 x 25	0.78				
270	25 x 45	1.25	25 x 50	1.31	25 x 50	1.36	25 x 45	0.93	30 x 45	1.51	30 x 50	1.5
	30 x 35	1.25	30 x 40	1.33	30 x 40	1.38	30 x 40	0.98	35 x 35	1.50	35 x 40	1.42
			35 x 30	1.30	35 x 30	1.35	35 x 30	0.92				
330	25 x 50	1.53	30 x 45	1.46	30 x 45	1.51	25 x 55	1.12	30 x 50	1.70	35 x 45	1.60
	30 x 40	1.53	35 x 35	1.45	35 x 35	1.50	30 x 45	1.14	35 x 40	1.70		
	35 x 30	1.50					35 x 35	1.09				
390	30 x 45	1.71	30 x 50	1.65	30 x 50	1.70	30 x 50	1.25	35 x 45	1.90	35 x 50	1.78
	35 x 30	1.60	35 x 40	1.65	35 x 40	1.70	35 x 40	1.25				
470	30 x 50	1.85	35 x 45	1.85	35 x 45	1.90	35 x 45	1.44	35 x 50	2.10	35 x 60	2.03
	35 x 35	1.75										
560	35 x 40	2.00	35 x 50	2.10			35 x 50	1.64				
680	35 x 45	2.20										

Note: 1. Ripple Current: (A/rms) 105°C, 120Hz

2. Dissipation Factor: 20°C, 120Hz

3. ESR: 120Hz / 20°C (Ω Max.)

# LS [ High Temperature and Long Life ]

Snap-in Terminal 105°C 7000 Hours, Wide Temperature Range and Long Life

## Large Can Aluminum Electrolytic Capacitors

### ELECTRICAL CHARACTERISTICS

Operating Temperature Range	-25 ~ +105°C	
Rated Voltage Range	350 ~ 450V	
Rated Capacitance Range	100 ~ 680μF	
Capacitance Tolerance	±20% at 120Hz, 20°C	
Leakage Current	Leakage Current (Max.) (20°C) : I = 0.02CV or 3μA whichever is greater. (After Rated Voltage Applied for 5 Minutes)	
Dissipation Factor (Max. tanδ) (20°C, 120Hz)	Rated Voltage (V)	350~450V
	D.F (%)	10.5
Endurance	After the rated voltage has been applied at 105°C for 7000 hours, the capacitors shall meet the following requirements. (a) Capacitance Change : Within ±20% of Initial Value (b) Dissipation Factor: Not Exceeding 200% of the Specified Value (c) Leakage Current: Not Exceeding the Specified Value	
Shelf Life	After having been placed at 105°C without voltage applied for 1000 hours, the capacitors shall meet the same requirements as Endurance.	

### DIAGRAM OF DIMENSIONS

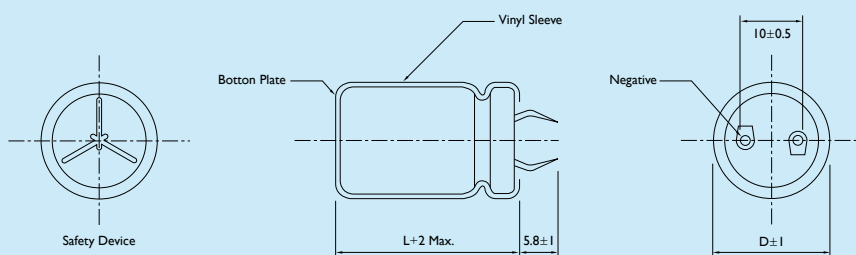

### DESCRIPTION

Long life, High ripple current.

Applications: Smoothing circuit, TV/Monitor, Adapter, SMPS

### MULTIPLIER FOR RIPPLE CURRENT

Frequency Coefficient

FREQUENCY (Hz)	50	60	120	400
COEFFICIENT	0.80	0.80	1.00	1.14
FREQUENCY (Hz)	1K	10K		
COEFFICIENT	1.30	1.40		

### FEATURES

105°C 7000 hours assured

Suitable for high voltage circuits

RoHS compliance

Unit: mm

### Location of P.C.B. Holes

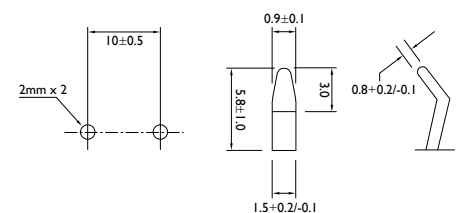

## CASE SIZE & PERMISSIBLE RIPPLE CURRENT OF STANDARD PRODUCTS

D x L: mm

CAP. (μF)	RATED VOLTAGE WV (SURGE VOLTAGE WV)							
	350(400) SIZE		400 (450) SIZE		450 (500) SIZE		500 (550) SIZE	
		RIPPLE		RIPPLE		RIPPLE		RIPPLE
100			25 x 25	0.70	22 x 40	0.74	22 x 45	0.67
	22 x 25	0.67	22 x 30	0.70	25 x 30	0.72	25 x 40	0.67
					30 x 35	0.73	30 x 30	0.67
120	22 x 30	0.77	22 x 35	0.79	25 x 35	0.82	25 x 40	0.74
	25 x 25	0.76	25 x 30	0.79	30 x 30	0.82	30 x 35	0.77
150	25 x 30	0.96	25 x 30	0.88	25 x 40	0.94	25 x 45	0.82
	22 x 35	0.88	30 x 25	0.90	30 x 35	0.96	30 x 40	0.85
180	22 x 40	0.99	22 x 45	0.99	30 x 35	1.05	25 x 50	0.98
	25x30	0.96	30 x 30	1.01	35 x 30	1.07	30 x 45	1.01
220	22 x 45	1.12	30 x 40	1.33	30 x 40	1.20	30 x 50	1.12
	25 x 35	1.11	30 x 35	1.16	35 x 35	1.21	35 x 40	1.11
	30 x 30	1.11						
270	25 x 40	1.26	30 x 40	1.33	35 x 40	1.40	30 x 50	1.25
	30 x 35	1.28	35 x 30	1.31	30 x 50	1.41	35 x 45	1.25
330	25 x 45	1.40	30 x 45	1.52	35 x 45	1.60	35 x 50	1.35
	30 x 35	1.42	35 x 35	1.48				
	35 x 30	1.45						
390	30 x 40	1.60	30 x 50	1.69	35 x 50	1.79		
	35 x 35	1.61	35 x 40	1.68				
470	30 x 50	1.86	35 x 45	1.91				
	35 x 40	1.85						
560	35 x 40	2.02	35 x 50	2.14				
680	35 x 50	2.36						

Note: 1. Ripple Current: (A/rms) 105°C, 120Hz

2. Dissipation Factor: 20°C, 120Hz

3. ESR: 120Hz / 20°C (Ω Max.)



## YAGEO - A GLOBAL COMPANY

### HQ

#### Taipei, Taiwan

Tel. +886 2 6629 9999 ext 3278

Fax. +886 2 6628 8886

### China and ASIA

#### Suzhou, China

Tel. +886 2 6629 9999 ext 3278

Fax. +886 2 6628 8886

#### Shanghai, China

Tel. +886 2 6629 9999 ext 3278

Fax. +886 2 6628 8886

#### Dongguan, China

Tel. +886 2 6629 9999 ext 3278

Fax. +886 2 6628 8886

#### Tokyo, Japan

Tel. +81 3 6809 3972

Fax. +81 3 6809 3982

#### Seongnam, Korea

Tel. +82 31 712 4797

Fax. +82 31 712 5866

#### Singapore

Tel. +65 6244 7800

Fax. +65 6244 4943

#### Kuala Lumpur, Malaysia

Tel. +60 3 8063 8864

Fax. +60 3 8063 7376

#### Penang, Malaysia

Tel. +60 4 3973049

Fax. +60 4 3973050

### EUROPE

#### Munich, Germany

Tel. +49 8990 7784 380

Fax. +49 8990 7784 379

#### Milan, Italy

Tel. +39 02 6129 1017

Fax. +39 02 6601 7490

#### Roermond, Benelux

Tel. +31 475 385 555

Fax. +31 475 385 589

#### Szombathely, Hungary

Tel. +36 94 517 702

Fax. +36 94 517 701

#### Moscow, Russian Federation

Tel. +886 2 6629 9999 ext 3278

Fax. +886 2 6628 8886

### NORTH AMERICA

#### Jose, U.S.A.

Tel. +1 408 240 6200

Fax. +1 408 240 6201

#### Mexico

Tel. +1 408 240 6200

Fax. +1 408 240 6201

For a complete listing of all Yageo sales offices, distributors, and representatives, please visit "contact us" at

[www.yageo.com](http://www.yageo.com)

© YAGEO Corporation