

Cisco Catalyst 6500 Series Virtual Switching System

White Paper

December, 2012

Contents

Introduction	3
Cisco Catalyst 6500 Series Virtual Switching System: An Overview	3
Cisco Catalyst 6500 Series Virtual Switching System Architecture	3
Virtual Switch Link	7
Virtual Switch Link Initialization.....	8
Hardware and Software Requirements	10
Virtual Switch Link Redundancy	13
Multiple Cisco Virtual Switching System Domains	15
Cisco EtherChannel Concepts	16
Multichassis Cisco EtherChannel Links	19
Virtual Switch Mode	20
Conversion to Virtual Switch Mode	21
Operational Management	25
Console Management	25
Interface Numbering.....	26
File-System Naming	26
Reloading the Cisco Virtual Switching System and Its Members	27
High Availability	28
Quad-Sup Uplink Forwarding	29
Configuration Synchronization.....	33
Virtual Switch Priorities and Switch Preemption.....	33
Virtual Switch Priorities.....	33
First Hop Redundancy Protocols.....	35
Detection Mechanisms and Configuration.....	41
Action Upon Dual-Active Detection.....	45
Quality of Service	47
VSL as a Congestion Point.....	47
Control Traffic over VSL.....	50
Using Supervisor Engine 720-10G VSS 10 Gigabit Ethernet Uplink Ports as VSL Interfaces.....	50
Applying Policies.....	51
Policing.....	51
Aggregate Policing.....	51
Microflow Policing and User-Based Rate Limiting.....	52
Access Control Lists.....	53
Router ACLs.....	54
VLAN ACLs.....	54
Port-Based ACLs.....	55

Introduction

The Cisco Catalyst 6500 Series Virtual Switching System (VSS) allows the clustering of two or more physical chassis together into a single, logical entity. This technology allows for enhancements in all areas of network design, including high availability, scalability, management, and maintenance.

This paper explains the Cisco VSS technology, including its benefits and requirements.

Cisco Catalyst 6500 Series Virtual Switching System: An Overview

The Cisco Catalyst 6500 Series Virtual Switching System (VSS) allows the merging of two physical Cisco Catalyst 6500 Series switches together into a single, logically managed entity. Figure 1 graphically represents this concept, where you can manage two Cisco Catalyst 6509 chassis as a single, 18-slot chassis after enabling Cisco Virtual Switching System.

Figure 1. Cisco Virtual Switching System Physical to Logical Representation

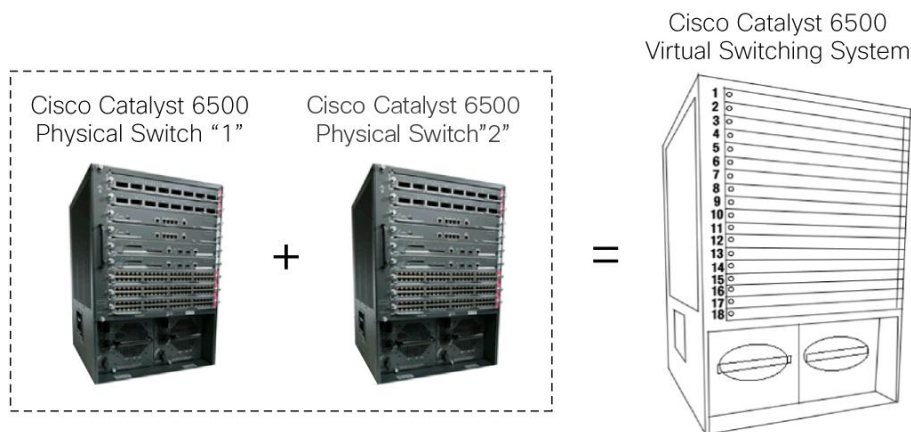

The Virtual Switching System is created by converting two standalone Catalyst 6500 systems to a Virtual Switching System. The conversion is a one-time process that requires a few simple configuration steps and a system reload. Once the individual chassis reload, they are converted into the Virtual Switching System.

The Virtual Switching System is supported with specific hardware and software components, including the Supervisor Engine 720-10G and the Supervisor Engine 2T.¹

Cisco Catalyst 6500 Series Virtual Switching System Architecture

The Cisco Catalyst 6500 Series Virtual Switching System allows the combination of two switches into a single, logical network entity from the network control plane and management perspectives. It uses Cisco IOS Stateful Switchover (SSO) technology, as well as Non-Stop Forwarding (NSF) extensions to routing protocols, to provide a single, logical switching and routing entity. To neighboring devices, the Cisco Virtual Switching System appears as a single, logical switch or router.

Within the Cisco Virtual Switching System, one chassis is designated as the active virtual switch, and the other is designated as the standby virtual switch. All control plane functions are centrally managed by the active supervisor engine of the active virtual switch chassis, including:

¹ See the "Hardware and Software Requirements" section of this document for details on all VSS hardware and software requirements.

- Management (Simple Network Management Protocol [SNMP], Telnet, Secure Shell [SSH] Protocol, etc.)
- Layer 2 Protocols (bridge protocol data units [BPDUs], protocol data units [PDUs], Link Aggregation Control Protocol [LACP], etc.)
- Layer 3 Protocols (routing protocols, etc.)
- Software data path

The supervisor engine on the active virtual switch is also responsible for programming the hardware forwarding information onto all the distributed forwarding cards (DFCs) across the entire Cisco Virtual Switching System. It also programs the policy feature card (PFC) on the standby virtual switch supervisor engine.

Figure 2. Components of Cisco Virtual Switching System

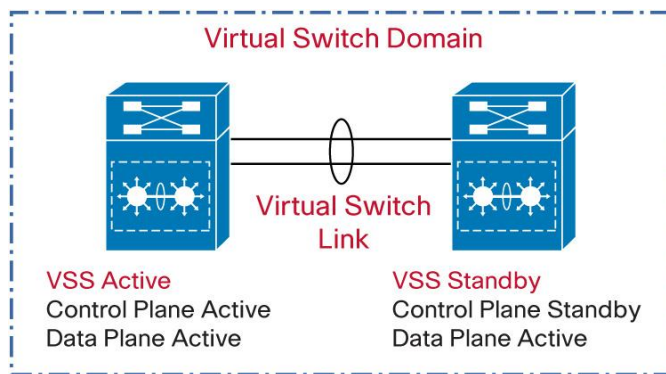

From data-plane and traffic-forwarding perspectives, both switches in the Cisco Catalyst 6500 Series Virtual Switching System actively forward traffic. The Policy Feature Card (PFC) on the active virtual switch supervisor engine performs central forwarding lookups for all traffic that ingresses the active virtual switch. The PFC on the standby virtual switch supervisor engine performs central forwarding lookups for all traffic that ingresses the standby virtual switch. Additionally, all Distributed Forwarding Cards, DFCs across the entire Cisco Virtual Switching System can also simultaneously perform packet lookups.

Centralized Management

The fundamental design of a Cisco Catalyst 6500 Series Virtual Switching System allows the centralized management of all network and device resources. This includes Layer 3 protocols, such as Open Shortest Path First [OSPF], Enhanced Interior Gateway Routing Protocol [EIGRP], Border Gateway Protocol [BGP], etc.), as well as Layer 2 protocols (Spanning Tree Protocol, Unidirectional Link Detection Protocol [UDLD], Flow Control, LACP, etc.). A single supervisor engine in the Cisco Virtual Switching System is elected as the central management point for the entire system.

The chassis containing the supervisor engine acting as the single management point is referred to as the active virtual switch. The peer chassis is referred to as the standby virtual switch. The single supervisor engine acting as the single management point is referred to as the active supervisor engine, and the peer supervisor engine in the standby virtual switch chassis is referred to as the hot-standby supervisor engine. You can verify this setup with the following commands:

```
vss#show switch virtual
Switch mode: Virtual Switch
Virtual switch domain number: 200
Local switch number: 1
```

Local switch operational role: Virtual Switch Active
Peer switch number: 2
Peer switch operational role: Virtual Switch Standby

VSS-Sup720#show switch virtual redundancy

My Switch Id = 1
Peer Switch Id = 2
Last switchover reason = none
Configured Redundancy Mode = sso
Operating Redundancy Mode = sso

Switch 1 Slot 6 Processor Information:

Current Software state = ACTIVE
Uptime in current state = 6 weeks, 5 days, 16 hours, 19 minutes
Image Version = Cisco IOS Software, s72033_rp Software
(s72033_rp-ADVIPSERVICESK9_WAN_DBG-M), Version 12.2(33.0.6)SXJ_gdb ENGINEERING
WEEKLY BUILD, synced to sierra SIERRA_INTEG_110521
Copyright (c) 1986-2011 by Cisco Systems, Inc.
Compiled Sat 25-Jun-11 00:35 by integ
BOOT = sup-bootdisk:s72033-advipservicesk9_wan_dbg-
mz.122-33.0.6.SXJ_gdb,1;
CONFIG_FILE =
BOOTLDR =
Configuration register = 0x2102
Fabric State = ACTIVE
Control Plane State = ACTIVE

Switch 2 Slot 6 Processor Information:

Current Software state = STANDBY HOT (switchover target)
Uptime in current state = 6 weeks, 5 days, 16 hours, 15 minutes
Image Version = Cisco IOS Software, s72033_rp Software
(s72033_rp-ADVIPSERVICESK9_WAN_DBG-M), Version 12.2(33.0.6)SXJ_gdb ENGINEERING
WEEKLY BUILD, synced to sierra SIERRA_INTEG_110521
Copyright (c) 1986-2011 by Cisco Systems, Inc.
Compiled Sat 25-Jun-11 00:35 by integ
BOOT = sup-bootdisk:s72033-advipservicesk9_wan_dbg-
mz.122-33.0.6.SXJ_gdb,1;
CONFIG_FILE =
BOOTLDR =
Configuration register = 0x2102
Fabric State = ACTIVE
Control Plane State = STANDBY

Router MAC Addresses

When a virtual switch boots up and transitions to an active state, it assigns all its Layer 3 interfaces with a MAC address. From a default configuration, the MAC address is derived from an EEPROM memory device located on the Catalyst 6500 chassis itself. Whichever supervisor is elected to the active role will provide the system MAC address for the VSS. The EEPROM is programmed in the factory and contains range of unique MAC addresses.

When the standby virtual switch is brought online after VSL activation, it also derives its router MAC addresses from the MAC EEPROM of the active virtual switch. From this point onward, even if a switchover occurs between the virtual switches (causing a role change), the MAC address remains consistent (Figure 3). In other words, the virtual switch will change its router MAC address after a supervisor switchover event.

Figure 3. MAC Address Synchronization Across Cisco Virtual Switching System

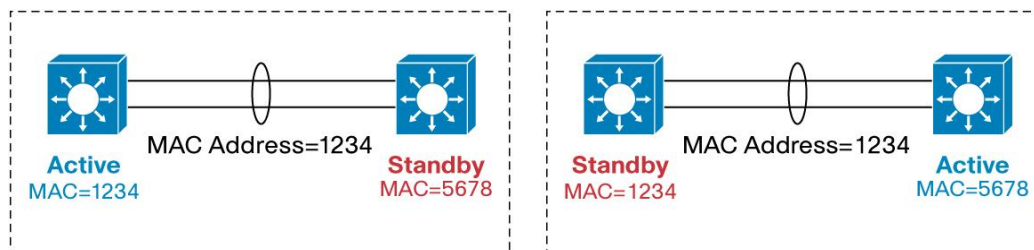

If the entire Cisco Virtual Switching System is restarted and brought online again, but the peer switch assumes the active virtual switch role on activation, the router MAC address will then be derived from the peer switch. Consequently, the router MAC addresses will be different from before the system reload. In most environments, this change does not represent a problem, because gratuitous Address Resolution Protocol (ARP) frames advertising the new router MAC addresses are transmitted upon interface initialization.

To avoid reliance on gratuitous ARP for advertising the router MAC address, alternative methods have been developed. The first option is called "Virtual MAC Address." Using the Virtual MAC Address feature, the router MAC address will be derived from a formula that uses the domain-id of the VSS pairs, combining MAC address from a pool of MAC addresses dedicated just for VSS. This helps ensure that the router MAC address is unique for a virtual switch domain and will remain the same, irrespective of which becomes active. The Virtual MAC address feature is available with Supervisor Engine 720-10G implementations, beginning with software release 12.2(33)SXH1, and is available with all software releases for the Supervisor Engine 2T.

Example Virtual MAC Address configuration

```
VSS(config-vs-domain)# switch virtual domain 100
VSS(config-vs-domain)# mac-address use-virtual
VSS (config-vs-domain)#mac-address use-virtual
Configured Router mac address (0008.e3ff.fd34) is different from operational
value (0013.5f48.fe40). Change will take effect after the configuration is saved
and the entire Virtual Switching System (Active and Standby) is reloaded.
VSS(config-vs-domain)#
```

As a best practice when using the Virtual MAC Address feature, it is recommend to always use a unique Virtual Switch Domain IDs for every VSS in a given network. This helps ensure a unique virtual MAC address for each system.

Virtual Switch Link

The Cisco Catalyst 6500 Series Virtual Switching System consists of two Cisco Catalyst 6500 chassis. In order to bond the two chassis together into a single, logical node, special signaling and control information must be exchanged between the two chassis in a timely manner. To facilitate this information exchange, a dedicated link is used to transfer both data and control traffic between the peer chassis. This link is referred to as the virtual switch link (VSL).

The VSL, formed as a Cisco EtherChannel interface, can comprise links ranging from one to eight physical member ports. These links carry two types of traffic: the Cisco Virtual Switching System control traffic and normal data traffic.

To make sure that control traffic gets highest priority across the VSL, a special bit is set on all VSL control frames. This helps ensure that these frames always get priority service from both ingress and egress hardware queues. From a data-plane perspective, the VSL is used to extend the internal chassis data path to the neighboring chassis. Data traffic sent on the VSL is load-balanced, using the configured Cisco EtherChannel load-balancing algorithms.

All frames that are sent across the VSL are encapsulated with a virtual switch header (VSH), which is appended to the frame by the egress port application-specific integrated circuit (ASIC) and striped off on the other side of the VSL by the ingress port ASIC. The VSH carries information such as the ingress port index, destination port index, VLAN, class of service (CoS), etc. The size of the VSH is the same as that of the internal compact header used by the Cisco Catalyst 6500; it is 32 bytes long. This header is placed after the Ethernet preamble and directly before the Layer 2 header.

Figure 4. Virtual Switch Header

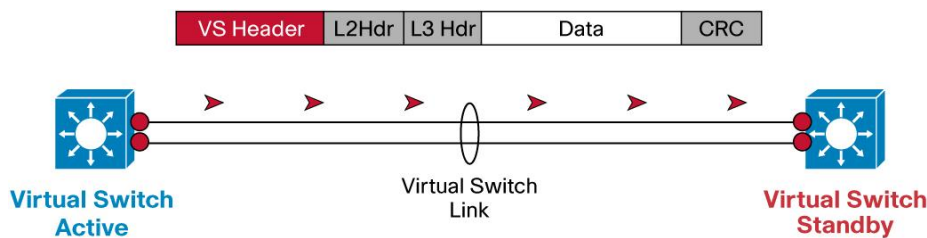

VSL Initialization

The VSS initialization process must determine which supervisor engine will become the active supervisor for the VSS. In order to determine the supervisor active and standby roles, the VSL must be initialized and brought online for control plane communication. Because this determination affects the behavior of each switch, the roles must be negotiated very early during the chassis bootup cycle. As a result, the system must bring the VSL and its associated ports online before initializing the rest of the system.

Communication between the two chassis is facilitated with internal messaging that is sent across the VSL. Because the VSL is implemented as a Cisco EtherChannel interface, it is resilient to single-link failures.

Virtual Switch Link Initialization

The system must bring the VSL online before activating the Cisco Virtual Switching System. The initialization sequence consists of the following steps:

Figure 5. VSL Initialization

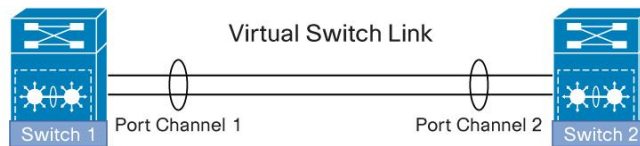

- 1 **Pre-parse config file** and bring up VSL interfaces
- 2 **Link Management Protocol (LMP)** used to track and reject Unidirectional Links, Exchange Chassis ID and other information between the 2 switches
- 3 **Role Resolution Protocol (RRP)** used to determine compatible Hardware and Software versions to form the VSL as well as determine which switch becomes Active and Hot Standby from a control plane perspective

- VSL initialization

The supervisor CPU determines which ports local to its chassis form members of the VSL, the configuration file is prepared to extract the appropriate VSL commands and their associated interfaces. This way, the modules containing these interfaces can be powered up, and VSL interfaces brought online.

The Link Management Protocol (LMP) operates on each link of the VSL and is part of the Virtual Switch Link Protocol (VSLP). The LMP performs the following functions:

- Verifies link integrity by establishing bidirectional traffic forwarding, and rejects any unidirectional links
- Exchanges switch IDs between the two chassis
- Exchanges other information required to establish communication between the two chassis

- VSS role resolution

The redundancy role of each supervisor engine is resolved by VSLP. The Role Resolution Protocol (RRP), performs the following functions:

- Determines whether the hardware and software versions allow a Cisco Virtual Switching System to be formed
- Determines which chassis will become the active virtual switch and which will become the standby virtual switch chassis from a control-plane perspective.

- High-availability role determination

After the role resolution, the active and standby image versions and configurations are checked for compatibility. This helps ensure that the hardware and software versions are the same on both chassis supervisor engines. The configuration check makes sure that the VSL-related configurations on the two switches are compatible. If either of the two checks fails, then the standby chassis comes up in route-processor redundancy (RPR) mode, where all modules are powered down, as opposed to Nonstop Forwarding/Stateful Switchover (NSF/SSO) mode, where the standby chassis is fully initialized and can forward traffic.

An example of how configuration checking may force the system into RPR mode is provided in the following output:

```
*Jun 29 14:05:44.731: %VSLP-SW2_SP-5-RRP_ROLE_RESOLVED: Role resolved as ACTIVE
by VSLP
*Jun 29 14:05:44.735: %VSL-SW2_SP-5-VSL_CNTRL_LINK: vsl_new_control_link NEW VSL
Control Link 5/4
*Jun 29 14:05:44.735: %VSL-SW2_SP-2-VSL_STATUS: === VSL is UP
*Jun 29 14:08:22.294: %VS_PARSE-3-CONFIG_MISMATCH: The system:/running-config VSL
config comparison failed
Switch 2 has the following configs that mismatch with Switch 1:
Interface TenGigabitEthernet1/5/4 shutdown
*Jun 29 14:08:22.210: SW2_SP: VS_PARSE_DBG_ERR: vs_redun_send_check_vs_config:
icc_req_resp_timeout_and_success: Failed
*Jun 29 14:08:22.210: SW2_SP: VS_PARSE_DBG: vs_redun_check_vs_config: running
config check on rp not ok
*Jun 29 14:08:22.218: %PFREDUN-SW2_SP-6-ACTIVE: Standby initializing for RPR mode
```

This output shows that the configuration consistency check failed because of a mismatch in the VSL configuration between Switch 1 and Switch 2. In this case, Switch 2 has an extra “shutdown” statement under one of its VSL members, whereas Switch 1 does not, forcing the standby virtual switch (in this case, Switch 1) into RPR mode.

In order to recover from this situation, make the necessary changes to the configuration, save the configuration, and reload the standby chassis:

```
vss#conf t
Enter configuration commands, one per line. End with CNTL/Z.
vss(config)#int tel/5/4
vss(config-if)#no shut
vss(config-if)#^Z
vss#wr
Building configuration...
*Jun 29 14:28:53.906: %SYS-5-CONFIG_I: Configured from console by console
*Jun 29 14:29:04.834: %PFINIT-SW2_SP-5-CONFIG_SYNC: Sync'ing the startup
configuration to the standby Router. [OK]
vss#redundancy reload shelf 1
Reload the entire remote shelf[confirm]
Preparing to reload remote shelf
```

Upon reload of Switch 1, configurations are now synchronized and both switches can enter into NSF/SSO mode:

```
*Jun 29 14:40:46.101: VS_PARSE_DBG: vsl_mgr_parse_config_file:
vsl_mgr_parse_config_file:Open Succeeded for running config system:/running-
config
*Jun 29 14:40:46.029: SW2_SP: VS_PARSE_DBG: vs_redun_check_vs_config: running
config check on rp ok
*Jun 29 14:40:46.037: %PFREDUN-SW2_SP-6-ACTIVE: Standby initializing for SSO mode
*Jun 29 14:40:49.874: %PFINIT-SW2_SP-5-CONFIG_SYNC: Sync'ing the startup
configuration to the standby Router.
```

Hardware and Software Requirements

The Virtual Switching System supports a specific subset of hardware compared to what is supported in a standalone configuration or non-VSS configuration. Therefore it is important to understand these requirements when planning the configuration of a VSS.

Supervisor Engines

The initial release of the Virtual Switching System on the Cisco Catalyst 6500 was in January 2008, with the Supervisor Engine 720-10G. In 2011, the Supervisor Engine 2T was released, which also supports VSS.

Each supervisor engine is available in two different forwarding configurations, XL and non-XL. The XL configuration provides higher capacity hardware forwarding tables and forwarding engine-related resources. Therefore, there are a total four different supervisor engine model numbers capable of supporting VSS. These are based on the Supervisor Engine 2T and the Supervisor Engine 720-10G.

The four Supervisor Engine Model Numbers supporting VSS are:

VS-S2T-10G

VS-S2T-10G-XL

VS-S720-10G-3C

VS-S720-10G-3CXL

Table 1. VSS Capable Supervisor Comparison

Supervisor Engine/ Feature	VS-S2T-10G	VS-S2T-10G -XL	VS-S720-10G-3C	VS-S720-10G-3CXL
Routes	256K (IPv4) 128K (IPv6)	1024K (IPv4) 512K (IPv6)	256K (IPv4) 128K (IPv6)	1024K (IPv4) 512K (IPv6)
IPv4 Forwarding Rate	In hardware; up to 720 Mpps	In hardware; up to 720 Mpps	In hardware; up to 450 Mpps	In hardware; up to 450 Mpps
IPv6 Forwarding Rate	In hardware; up to 390 Mpps	In hardware; up to 390 Mpps	In hardware; up to 225 Mpps	In hardware; up to 225 Mpps
Switch Fabric Capacity	2 Tbps (80 Gbps per slot including the 6513-E chassis)	2 Tbps (80 Gbps per slot in all chassis including the 6513-E chassis)	720 Gbps (40 Gbps per slot in all chassis except the 6513 and 6513-E)	720 Gbps (40 Gbps per slot in all chassis except the 6513 and 6513-E)
MPLS	Layer 3 VPNs and EoMPLS tunneling. Up to 8192 VRFs with a total of up to 256K forwarding entries per system.	Layer 3 VPNs and EoMPLS tunneling. Up to 8192 VRFs with a total of up to 1024K forwarding entries per system.	Layer 3 VPNs and EoMPLS tunneling. Up to 1024 VRFs with a total of up to 256K forwarding entries per system.	Layer 3 VPNs and EoMPLS tunneling. Up to 1024 VRFs with a total of up to 1024K forwarding entries per system.
VPLS	Any Ethernet LAN port in hardware (up to 390 Mpps*)	Any Ethernet LAN port in hardware (up to 390 Mpps*)	Supported with SIP and SPA modules	Supported with SIP and SPA modules
NetFlow Entries	512 K	1024 K	128 K	256 K
Layer-3 classification and marking access control entries (ACEs)	64 K shared for QoS/Security	256 K shared for QoS/Security	32 K QoS entries 32 K Security entries	32 K QoS entries 32 K Security entries
Chassis Supported	6500 E-series chassis only	6500 E-series chassis only	6500 E-series and 6500 non E-series	6500 E-series and 6500 non E-series

* Requires fully populated 6513-E chassis with DFC-enabled line cards

Forwarding Engine

The Cisco Catalyst 6500 can be configured with a single centralized forwarding engine. In this case, the Policy Feature Card (PFC) is the sole forwarding engine for the system.

Optionally, the Cisco Catalyst 6500 can be configured with distributed forwarding engines to provide higher scalability and performance. In a distributed forwarding configuration, the line cards are populated with the Distributed Forwarding Daughter Cards (DFCs). These forwarding engines perform lookup functions for every frame that enters into the system, and determine the ultimate destination of the packet. They also provide value-added services, such as security access control list (ACL) and quality of service (QoS) lookups.

A Cisco Virtual Switching System-enabled Cisco Catalyst 6500 has two notable differences compared to a standalone Cisco Catalyst 6500 system. First, both the active and the hot-standby supervisor engine PFCs are active, and are used to perform packet lookups for centralized lookups on each chassis. Second, all forwarding engines are able to support an increased amount of port index information to be able to address a fully populated Cisco Virtual Switching System-enabled chassis. In other words, a port index is now defined using the switch number, in addition to the slot and port number.

The Supervisor Engine 720-10G Policy Feature Card 3C/XL (PFC3C), as well as the Supervisor Engine 2T Policy Feature Card 4/XL (PFC4) forwarding engines, are capable of supporting the additional port indices, as well as the active-active forwarding configuration.

System PFC Operating Mode

The system PFC operating mode determines the overall forwarding engine mode for the system. It includes both the version and the type; for example, a Version 3 or Version 4 PFC, or a type XL or non-XL. The PFC version indicates specific architectural implementations with support for a specific forwarding performance level and feature sets. The version type indicates the size and capacity of different hardware resources, including the size of the L2 and L3 forwarding tables, Access Control List entries and related resources, and NetFlow table resources.

The VSS requires that the system PFC operating mode is in PFC3C or PFC4; a mix of PFC3 and PFC4 forwarding engines is not supported. The differences between the PFC3 and PFC4 forwarding engines are significant enough that a compatibility mode is not supported. However, one can operate with a mix of non-XL and XL versions, as long as the forwarding engines are all PFC3 or all PFC4.

In the case of the Supervisor Engine 720-10G, there are additional versions of the PFC3 forwarding engine, including the PFC3A and PFC3B. Again, the VSS requires the PFC3C mode or above. If a lower-mode module was previously inserted into the chassis that forced the system mode of operation to PFC3A, PFC3B, or PFC3BXL mode, then the Cisco Virtual Switching System function will not be enabled on the system. Likewise, if a module with a lower-mode DFC is inserted into the chassis after conversion to Cisco Virtual Switching System mode, the system will not grant power to the module.

You can verify the PFC operating mode of the system with the following command:

Example for Sup720-10GE:

```
vss#show platform hardware pfc mode
PFC operating mode : PFC3C
Configured PFC operating mode : None
```

Example for Sup2T:

```
vss#show platform hardware pfc mode
PFC operating mode : PFC4
Configured PFC operating mode : None
```

Additionally, as an optional configuration, the supervisor engines of both chassis may prenegotiate their modes to be in XL-mode or non-XL-mode. This is useful if one wants to help ensure that a VSS running in PFC3C-XL or PFC4-XL mode will not negotiate to a non-XL mode in the event a non-XL line card is inserted into the system.

Example for configuring PFC4 non-XL mode on Sup2T

```
vss#platform hardware vsl pfc mode non-XL
In VSS mode, system EARL mode will be forced to non-XL on next bootup
Virtual Switch Link-Capable Interfaces
```

VSL-capable interfaces are required to create a VSL port channel. These interfaces contain port ASICs that allow the Virtual Switch Header (VSH) to be encapsulated on each frame forwarded out of the port and also support the ability to deencapsulate VSH-tagged frames. The only 10 gigabit Ethernet module which is not supported as a VSL port is the WS-X6704-10GE module.²

Table 2. VSL-Capable Interfaces

Module	Description	# VSL Ports 10 GE (Capable)
VS-S2T-10G/XL	Supervisor Engine 2T	2
WS-X6904-40-2T/2TXL	40 GE Linecard/10 GE Linecard	4 (40 Gigabit Ethernet) 8 (10 Gigabit Ethernet)
WS-X6908-10G-2T/2TXL	10 GE Linecard	8
WS-X6816-10G-2T	16-Port 10 GE X2 Fiber Linecard with DFC4/DFC4XL	4 (Performance mode) *
WS-X6816-10T-2T/2TXL	16-Port 10 GE Copper Linecard with DFC4/DFC4/XL	4 (Performance mode) *
VS-S720-10G-3C/XL	Supervisor Engine 720-10GE	2
WS-X6708-10G-3C/XL	10 GE Linecard	8
WS-X6716-10G-3C/XL	16-Port 10GE X2 Fiber Linecard with DFC3C/DFC3CXL	4 (Performance mode) *
WS-X6716-10T-3C/XL	16-Port 10GE Copper Linecard with DFC3C/DFC3C/XL	4 (Performance mode) *

* The WS-X6716-10G-3C/XL can operate in two modes - Oversubscription and Performance (only 1 port from each port-group can be used).

Supported Chassis

From a chassis perspective, the supported chassis types follow the support of the supervisor engine. Therefore, for a Supervisor Engine 720-10 G-based system, both non-E-series chassis, as well as E-series chassis, are supported. However, with a Supervisor Engine 2T-based system, only E-series chassis are supported.³

There is no requirement to match the types of chassis used in the VSS. The chassis consisting of the Cisco Virtual Switching System can be different chassis with varying slot counts.

² The WS-X6704-10GE module is supported in the VSS as a line card but cannot be used as part of the VSL.

³ Refer to the system Release Notes documentation located at <http://www.cisco.com> for the most current list of supported hardware devices.

Other Supported Modules

Supported interface modules that can coexist within a Cisco Virtual Switching System-enabled chassis include all CEF720 modules (WS-X6700 series). These modules can also support either a centralized forwarding card (CFC) or a DFC. If a DFC is installed, it must be compatible with the supervisor PFC operating mode (for example, PFC3C mode for the Supervisor Engine 720-10G and PFC4 mode for the Supervisor Engine 2T). A lower-mode DFC inserted in the module will be denied system power until the system-wide PFC mode has been configured and the system is reloaded.

In a VSS configuration, neither 6100-series nor 6500-series modules are supported. These modules may be supported in a standalone configuration depending upon the supervisor engine support.

Virtual Switch Link Redundancy

The Virtual Switch Link (VSL) is clearly a vital part of the VSS. It provides the signaling path used for synchronizing the two supervisor engines' control planes, as well as providing the data path for any user data traffic needing to pass between the two chassis. Therefore, the VSL was developed as an EtherChannel interface allowing for redundant interfaces and higher bandwidth capacity.

Given the hardware requirements discussed in the architecture section of this paper, the VSL must be configured using specific types of 10 Gigabit or 40 Gigabit Ethernet ports. The main requirement is that the port is capable of supporting the Virtual Switch Header (VSH) on all traffic traversing the VSL.

One other consideration is the VSL initialization process. VSL interfaces are enabled and initialized very early on during the system boot process. The reason for this is that the VSL is used to allow the two supervisor engines to communicate and negotiate the overall VSS control plane redundancy role. This determines which supervisor will become the VSS active and which will become the standby.

Figure 6. Summary of VSS Initialization Process

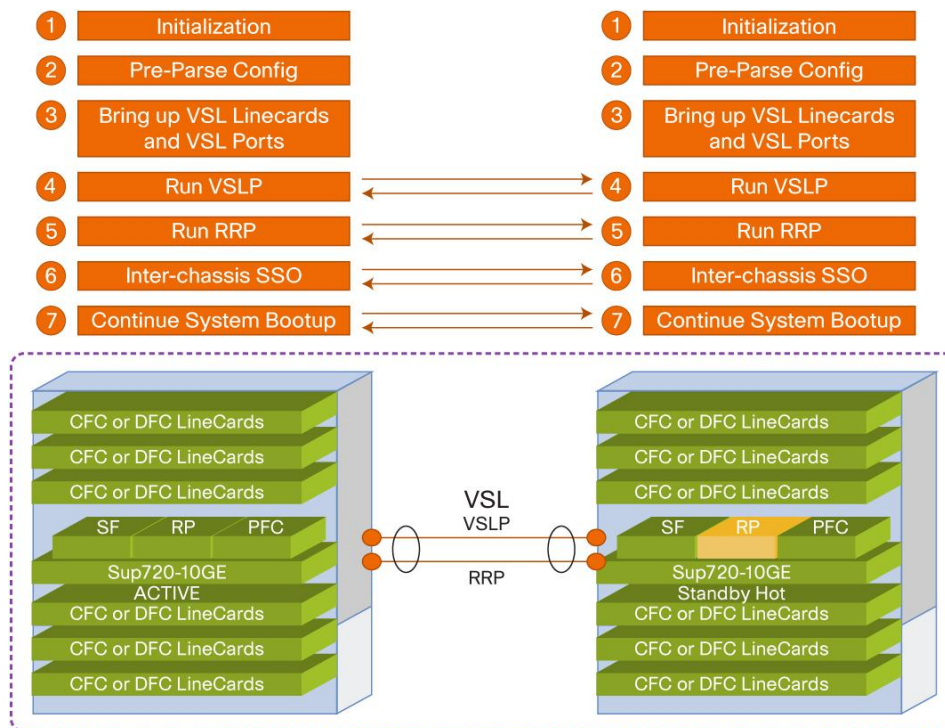

By configuring at least one of the supervisor uplink ports as a VSL port, the system will be able to initialize the VSL without having to initialize any other line cards. Therefore, it is beneficial and recommended to use at least one of the supervisor module 10 Gigabit Ethernet uplink ports for the VSL.

Two-Port VSL Using Supervisor-Engine Uplinks

In this scenario, the two members of the Cisco Virtual Switching System are connected through a 2-port VSL EtherChannel. The VSL is formed out of the two 10 Gigabit Ethernet uplink ports on the supervisor module installed in Slot 5 of each chassis.

Figure 7. VSL Formed Using Two 10 Gigabit Ethernet Supervisor Ports

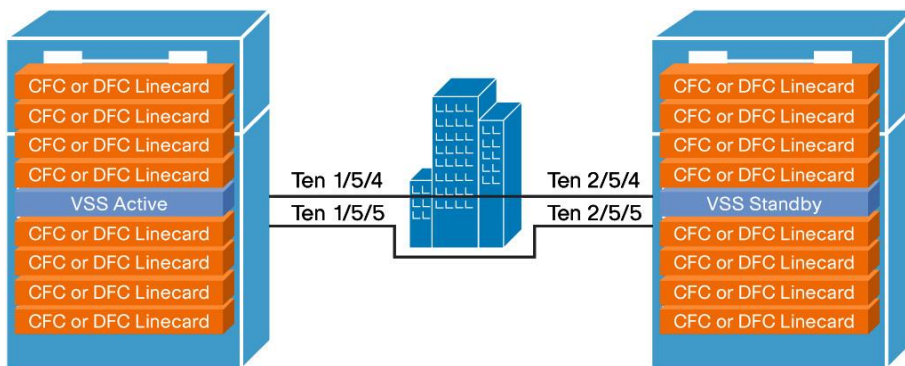

A two-port VSL using supervisor ports offers:

- A minimum of two links providing protection from port and SFP failures
- Diverse physical paths, to protect from physical layer outages
- No requirement for additional VSL-capable line cards (minimal cost)

If additional bandwidth is needed for the VSL, additional 10 Gigabit ports from supported line cards can be used. Up to eight ports per port channel can be added, the same as with any other port channel interface.

Four-Port VSL Using Quad-Sup Uplink Forwarding

The Supervisor 720-10 G supports the Quad-Sup Uplink Forwarding⁴ feature, which allows for a redundant in-chassis supervisor module. Again, it is recommended to build the VSL with at least one port from each supervisor module. If desired, you can use all the 10 Gigabit ports from the supervisor modules for the VSL. With this configuration, you should cross-connect one port from each supervisor to one port on each supervisor on the peer chassis. This will help ensure an active VSL port member local to the active supervisor, regardless of any supervisor module failure.

⁴ More details on the Quad-Sup Uplink Forwarding feature are provided in the High Availability section of this paper.

Figure 8. Quad-Sup Uplink Forwarding VSL Configuration

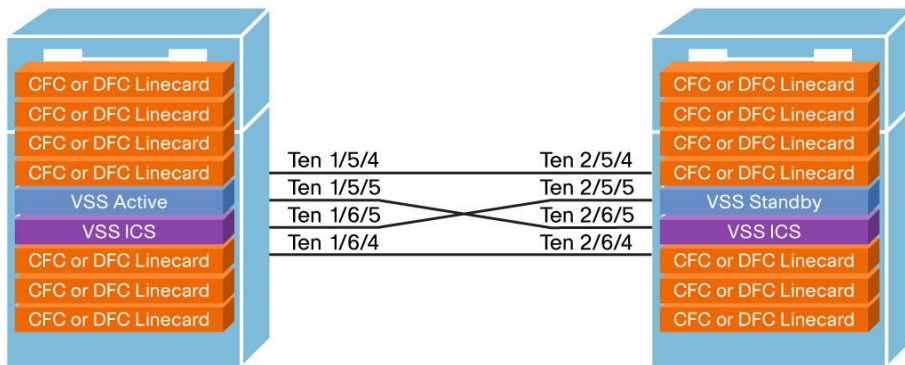

Quad-Sup Uplink Forwarding VSL design using all 10 Gigabit ports on the supervisor modules:

- Maintains 20 Gbps VSL bandwidth in the event of a supervisor failure
- Maintains at least one locally attached VSL port to the active supervisor, in the event of a supervisor module failure
- Requires no additional line cards

If additional bandwidth is needed for the VSL, additional 10 Gigabit ports from supported line cards can be used. Up to eight ports per port channel can be added, just like any other port channel interface.

Multiple Cisco Virtual Switching System Domains

Multiple deployments of Cisco Virtual Switching System can exist in a given network design, adding to the availability and scalability of the network. As a result, Cisco requires that you use unique virtual switch domain identifiers for each pair of VSS switches.

Figure 10 shows an example of multiple Cisco Virtual Switching System domains in a network design. The figure shows three unique VSS domains, each with a unique domain ID. You can also deploy multichassis Cisco EtherChannel links across other Cisco Virtual Switching Systems, removing the reliance on protocols such as Spanning Tree Protocol.

Figure 9. Multiple Cisco Virtual Switching System Domains

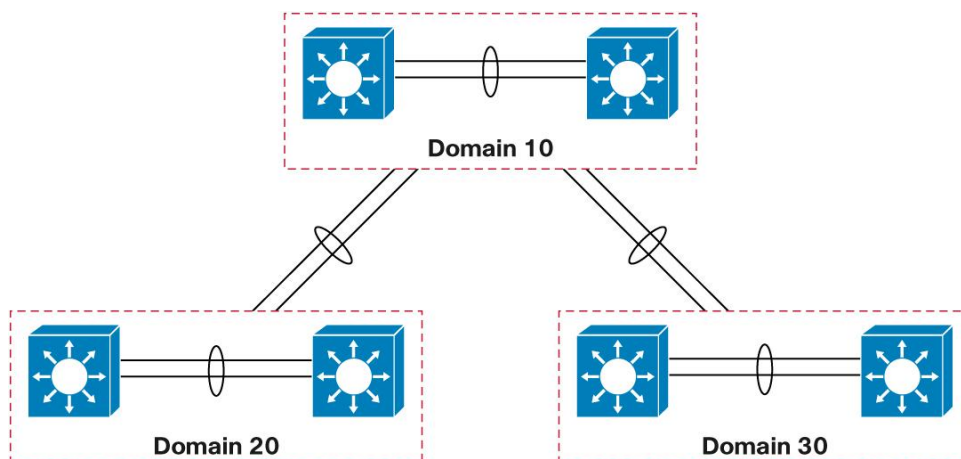

Another example of multiple Cisco Virtual Switching System domains is in the area of Layer 2 adjacent WAN deployments. It may be a requirement for the business or the applications that a routed Layer 3 WAN connection may not be possible requiring a Layer 2 connection between two disparate geographic sites, yet still providing link redundancy at the same time. This will ultimately require some form of Layer 2 redundancy protocol be implemented (such as Spanning Tree Protocol), resulting in complex topologies as well as inefficient bandwidth utilization across network links. By leveraging Cisco Virtual Switching System, such inefficiencies will be mitigated through the formation of multichassis Cisco EtherChannel connections.

Cisco EtherChannel Concepts

Cisco EtherChannel interfaces on the Cisco Catalyst 6500 platform represent a grouping of one or more physical ports into a single, logical port from the perspective of either a Layer 2 switching or Layer 3 routing environment. Cisco EtherChannel interfaces allow for individual link resiliency as well as providing added bandwidth without the necessity of complex protocols.

There are generally no restrictions with regard to which ports or modules can form members of a Cisco EtherChannel link, except that the member interfaces need to be of the same speed and no more than 8 members can belong to a single Cisco EtherChannel grouping. You can, therefore, extend members of the Cisco EtherChannel interface across switching modules to allow for the maximum availability of the Cisco EtherChannel interface if either a single link or module fails.

Traffic Distribution and Hashing

The distribution of traffic across the various members of the Cisco EtherChannel link is accomplished through different hash schemes, each using a fixed set of fields within the frame to determine which Cisco EtherChannel member is used to forward a particular traffic flow. With the Supervisor Engine 720-10 G, you can choose from 13 possible different hash schemes:

```
vss(config)#port-channel load-balance ?
dst-ip Dst IP Addr
dst-mac Dst Mac Addr
dst-mixed-ip-port Dst IP Addr and TCP/UDP Port
dst-port Dst TCP/UDP Port
mpls Load Balancing for MPLS packets
src-dst-ip Src XOR Dst IP Addr
src-dst-mac Src XOR Dst Mac Addr
src-dst-mixed-ip-port Src XOR Dst IP Addr and TCP/UDP Port
src-dst-port Src XOR Dst TCP/UDP Port
src-ip Src IP Addr
src-mac Src Mac Addr
src-mixed-ip-port Src IP Addr and TCP/UDP Port
src-port Src TCP/UDP Port
```

With the Supervisor Engine 2T, additional hash schemes supporting the source and destination VLAN are supported for up to 19 total options:

```
VSS2T(config)# port-channel load-balance ?
dst-ip                Dst IP Addr
dst-mac               Dst Mac Addr
dst-mixed-ip-port     Dst IP Addr and TCP/UDP Port
dst-port              Dst TCP/UDP Port
mpls                  Load Balancing for MPLS packets
src-dst-ip            Src XOR Dst IP Addr
src-dst-mac           Src XOR Dst Mac Addr
src-dst-mixed-ip-port Src XOR Dst IP Addr and TCP/UDP Port
src-dst-port          Src XOR Dst TCP/UDP Port
src-ip                Src IP Addr
src-mac               Src Mac Addr
src-mixed-ip-port     Src IP Addr and TCP/UDP Port
src-port              Src TCP/UDP Port
vlan-dst-ip           Vlan, Dst IP Addr
vlan-dst-mixed-ip-port Vlan, Dst IP Addr and TCP/UDP Port
vlan-src-dst-ip       Vlan, Src XOR Dst IP Addr
vlan-src-dst-mixed-ip-port Vlan, Src XOR Dst IP Addr and TCP/UDP Port
vlan-src-ip           Vlan, Src IP Addr
vlan-src-mixed-ip-port Vlan, Src IP Addr and TCP/UDP Port
```

Selection of the hash scheme of choice largely depends on the traffic mix through the Cisco EtherChannel interface, noting that these hash schemes may be selected only on a global basis.

Determination of Hash Result

With the release of Cisco Virtual Switching System, a new mechanism has been implemented to allow you to determine which physical link a given flow of traffic uses within a port-channel group. You provide inputs to the command, and the hashing algorithm computes the physical link that is selected for the traffic mix and algorithm.

```
vss#sh etherchannel load-balance hash-result ?
interface Port-channel interface
ip IP address
ipv6 IPv6
l4port Layer 4 port number
mac Mac address
mixed Mixed mode: IP address and Layer 4 port number
mpls MPLS
vss#sh etherchannel load-balance hash-result interface port-channel 120 ip
192.168.220.10 192.168.10.10
Computed RBH: 0x4
Would select Gi1/2/1 of Po120
```

Adaptive Load Balancing

The addition or removal of a member port from a Cisco EtherChannel interface has always led to a varied amount of traffic loss for customers. The current generation of port ASICs uses a 3-bit Result Bundle Hash (RBH) value from the PFC or DFC result to index into a load register. This allows a packet to be transmitted if the corresponding bit is set.

When a new port is added or deleted, the load value is reset on all the ports. A new load is then distributed on all the ports in the Cisco EtherChannel interface, including the new member, and reprogrammed into the port ASIC for each port. This process causes packets to be dropped during the short outage window (approximately 200 to 300 ms), an undesirable result for higher-speed interfaces such as 10 Gigabit Ethernet connections where a large amount of traffic may be lost during this brief outage window.

This problem has led to the development of an enhanced load-distribution mechanism. When ports are added or removed from a Cisco EtherChannel interface, the load result does not need to be reset on existing member ports, resulting in improved traffic recovery times.

You can implement this new algorithm either globally or on a per-port channel basis, where **fixed** is the current default mode and **adaptive** uses the enhanced mode:

```
vss(config)#port-channel hash-distribution ?
adaptive selective distribution of the bndl_hash among port-channel members
fixed distribution of the bndl_hash among port-channel members
vss(config)#int port-channel 4
vss(config-if)#port-channel port hash-distribution ?
adaptive selective distribution of the bndl_hash among port-channel members
fixed fixed distribution of the bndl_hash among port-channel members
```

The algorithm selected with these commands is applied only at the next hash-distribution instance, which usually occurs on a port-channel member link transition event:

```
vss#sh etherchannel 4 summary
Flags: D - down P - bundled in port-channel
I - stand-alone s - suspended
H - Hot-standby (LACP only)
R - Layer3 S - Layer2
U - in use N - not in use, no aggregation
f - failed to allocate aggregator
M - not in use, no aggregation due to minimum links not met
m - not in use, port not aggregated due to minimum links not met
u - unsuitable for bundling
d - default port
w - waiting to be aggregated
Number of channel-groups in use: 9
Number of aggregators: 9
Group Port-channel Protocol Ports
-----+-----+-----+-----
```

4 Po4(SU) PAgP Gi1/5/3(P) Gi2/5/3(P)

Last applied Hash Distribution Algorithm: Adaptive

Although this new load-distribution algorithm requires configuration for regular Cisco EtherChannel and multichassis Cisco EtherChannel interfaces, it is the default load-distribution algorithm used on the virtual switch links.

Multichassis Cisco EtherChannel Links

The multichassis Cisco EtherChannel interface spans more than a single physical switch (Figure 11). The Cisco Virtual Switching System allows the formation of this multichassis Cisco EtherChannel link. It also allows the dual-homed connections to and from the upstream and downstream devices to be configured as Cisco EtherChannel links, as opposed to individual links. As a result, multichassis Cisco EtherChannel links allow for implementation of new network designs where true Layer 2 multipathing can be implemented, without the reliance on Layer 2 redundancy protocols such as Spanning Tree Protocol. With 12.2(33)SXI and above, VSS supports 512 EtherChannels.

Figure 10. Multichassis Cisco EtherChannel Links

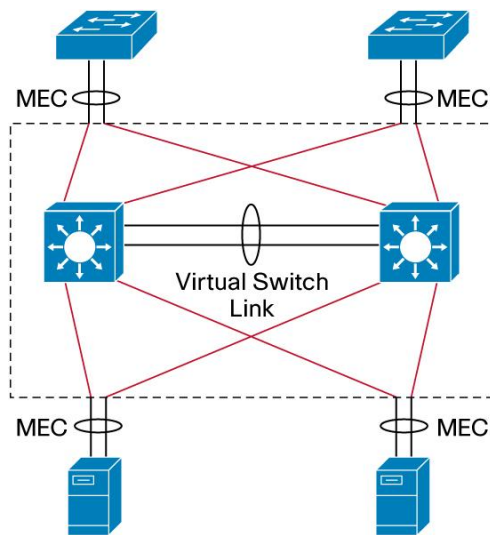

Like regular Cisco EtherChannel interfaces, all ports within the multichassis Cisco EtherChannel link have the same source index, regardless of the chassis in which they are physically present. This makes it possible to apply a single IP address for Layer 3 Cisco EtherChannel links or for Spanning Tree Protocol to view a Cisco EtherChannel interface as a single, logical port.

One unique difference between multichassis Cisco EtherChannel and regular Cisco EtherChannel interfaces is the way traffic is load-balanced across the channel group members. A regular Cisco EtherChannel link selects the appropriate channel group member to exit, based purely on the hashing algorithm of choice. A multichassis Cisco EtherChannel link, however, has some extra intelligence to reduce the amount of traffic that requires transmission across the VSL. This optimization is accomplished by populating the index port only with the ports local to the physical chassis. This allows the chassis to favor the local ports of the multichassis Cisco EtherChannel link over those on the remote chassis.

For traffic that must be flooded on the VLAN (broadcasts, multicasts, and unknown unicasts), a copy is sent across the VSL to be sent out any single-homed ports belonging to the VLAN. Because the first chassis will have sent a copy out one of the multichassis Cisco EtherChannel ports, packets received from the VSL are not sent out of another multichassis Cisco EtherChannel port. If all of the multichassis Cisco EtherChannel ports on a given chassis are removed because of a failure, management control, or other issue, the Cisco EtherChannel link is no longer a multichassis Cisco EtherChannel link. Instead it becomes a regular Cisco EtherChannel link, and hence, flooded packets will be sent out of this EtherChannel link from the VSL.

Although the data traffic is spread across the two chassis, the active supervisor engine must terminate control traffic for the multichassis Cisco EtherChannel link on the active virtual switch, including most of the Layer 2 protocols such as Spanning Tree Protocol, Port Aggregation Protocol (PAgP), VLAN Trunking Protocol (VTP), etc. All multichassis Cisco EtherChannel links have their control protocols terminated on the active supervisor engine. Any control protocols received by multichassis Cisco EtherChannel link ports on the standby virtual switch are redirected to the active supervisor engine through the VSL. Because the Cisco EtherChannel link is terminated in one chassis, PAgP and LACP have the same device identifier on all the member links, regardless of the chassis on which the link resides.

Multichassis Cisco EtherChannel Link Management Protocols

Multichassis Cisco EtherChannel links support both the Cisco proprietary Port Aggregation Protocol (PAgP) and the LACP, both of which run on the active supervisor engine on the active virtual switch. Protocol frames that the standby virtual switch receives are relayed to the active supervisor engine on the active virtual switch through the VSL.

Virtual Switch Mode

With the first release of software supporting the Cisco Virtual Switching System, you can run the switches in either standalone mode or virtual mode. The default configuration is for the individual chassis to operate in standalone mode. In order to migrate to virtual mode, you must perform a conversion procedure, outlined as follows.

After the chassis reloads and is operating in virtual mode, it begins the VSL initialization sequence. Additionally, the interface naming convention is changed to allow for the specification of a chassis identifier as part of the interface name. Please refer to the section “Operational Management” for more information.

Switch Identifier

Each chassis within the Cisco Virtual Switching System is allocated a unique chassis identifier upon conversion to virtual switch mode. This identifier is known as the switch identifier, or switch ID. This number is used as part of the interface naming, to help ensure that the interface name remains the same, regardless of the active or standby virtual switch roles.

As mentioned previously, this variable is set during the conversion phase. If a replacement supervisor engine is required, it is set with an enable-mode command-line interface (CLI) command. The variable that has been set is stored as a variable in ROMmon, so it is locally significant to the individual supervisor engine. If you need to alter the switch ID, use the following CLI:

```
VSS#switch set switch_num 1
Set rommon's switch_num to 1
VSS#switch read switch_num
Read switch_num from rommon is 1
```

If there is a misconfiguration in switch IDs (when both switches have the same switch ID), the formation of the VSL will fail on initialization. When the two chassis are being brought up as a single Cisco Virtual Switching System, the VSL initialization handshake verifies that the switch IDs of the two chassis do not match. If the switch ID is found to be in conflict, the VSL will not become active. If this situation occurs, both chassis assume the role of active virtual switch and you are informed of this conflict.

Conversion to Virtual Switch Mode

This section details the steps required to convert a standalone system into virtual switch mode. The interfaces forming the VSL should be connected prior to the conversion process, to minimize the number of times the chassis is reloaded. Additionally, you should begin the conversion process using a default configuration, as the conversion process removes any previous configuration that exists on the standalone chassis. Refer to Figure 11 to reference the conversion process.

Figure 11. Cisco Virtual Switching System Conversion

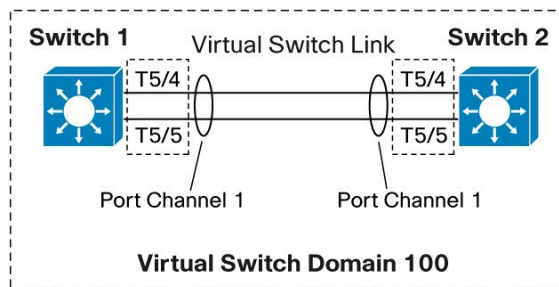

Step 1. Configure virtual switch ID and domain.

<pre> On the two switches, configure the same virtual switch domain number (in this case it is 100), but unique switch IDs using the following configuration mode commands: VSS-sw1#conf t Enter configuration commands, one per line. End with CNTL/Z. VSS-sw1(config)#switch virtual domain 100 Domain ID 100 config will take effect only after the exec command 'switch convert mode virtual' is issued VSS-sw1(config-vs-domain)#switch 1 VSS-sw1(config-vs-domain)# </pre>	<pre> VSS-sw2#conf t Enter configuration commands, one per line. End with CNTL/Z. VSS-sw2(config)#switch virtual domain 100 Domain ID 100 config will take effect only after the exec command 'switch convert mode virtual' is issued VSS-sw2(config-vs-domain)#switch 2 VSS-sw2(config-vs-domain)# </pre>
---	---

Note that as a result of this command, the domain ID is retained in the configuration, but the switch ID is not; this value is stored as a variable in ROMmon. It can be confirmed by issuing the following command on each switch:

<pre> VSS-sw1#switch read switch_num Read switch_num from rommon is 1 </pre>	<pre> VSS-sw2#switch read switch_num Read switch_num from rommon is 2 </pre>
--	--

Step 2. Configure the VSL port channel and member ports.

Choose unique port-channel IDs for each chassis to form the VSL and configure them with the corresponding switch ID, using the following commands:

<pre>VSS-sw1#conf t Enter configuration commands, one per line. End with CNTL/Z. VSS-sw1(config)#interface port-channel 1 VSS-sw1(config-if)#switch virtual link 1 VSS-sw1(config-if)#no shut VSS-sw1(config-if)#</pre>	<pre>VSS-sw2#conf t Enter configuration commands, one per line. End with CNTL/Z. VSS-sw2(config)#interface port-channel 2 VSS-sw2(config-if)#switch virtual link 2 VSS-sw2(config-if)#no shut VSS-sw2(config-if)#</pre>
---	---

Now, add the ports on each switch to the port channel that corresponds to the respective side of the VSL, using the following commands:

<pre>VSS-sw1(config)#interface range tenGigabitEthernet 5/4 - 5 VSS-sw1(config-if-range)#channel-group 1 mode on VSS-sw1(config-if-range)#no shut VSS-sw1(config-if-range)#^Z VSS-sw1#</pre>	<pre>VSS-sw2(config)#interface range tenGigabitEthernet 5/4 - 5 VSS-sw2(config-if-range)#channel-group 2 mode on VSS-sw2(config-if-range)#no shut VSS-sw2(config-if-range)#^Z VSS-sw2</pre>
--	---

Note that only the local port channels and their associated members need to be configured on each switch. Because the switches are still in standalone mode, you do not need to configure the peer-switch ports.

Step 3. Convert to virtual switch mode.

Convert both switches to virtual switch mode, using the following exec command:

<pre>VSS-sw1#switch convert mode virtual This command will convert all interface names to naming convention "interface-type switch- number/slot/port", save the running config to startup-config and reload the switch. Do you want to proceed? [yes/no]: yes Converting interface names Building configuration... [OK] Saving converted configurations to bootflash ... [OK]</pre>	<pre>VSS-sw2#switch convert mode virtual This command will convert all interface names to naming convention "interface-type switch- number/slot/port", save the running config to startup-config and reload the switch. Do you want to proceed? [yes/no]: yes Converting interface names Building configuration... [OK] Saving converted configurations to bootflash... [OK]</pre>
---	--

Four actions occur when you issue this command:

- The running configuration of the individual switch is converted into a three-level virtual switch interface notation. Two-level interface configurations (such as 10 GigabitEthernet 5/4) are converted into three-level interfaces (such as 10 GigabitEthernet 1/5/4 in Switch 1 and 10 GigabitEthernet 2/5/4 in Switch 2).
- The startup configuration is updated with the three-number notation.
- A copy of the original startup configuration converted to three-number notation is written to the multilayer switch feature card (MSFC) bootflash of the respective switch. Both switches reload.

Note that the command **switch convert mode virtual** is not stored in the startup configuration because it is not a configuration command. Instead, the following line is added to the startup configuration under the **switch virtual domain**:

When the two switches are brought online, they proceed with VSL initialization and initialize their respective VSL ports. The two switches communicate with each other and determine active and standby roles. This exchange of information is evident through the following console messages:

```
VSS#sh run | begin switch virtual domain
switch virtual domain 100
switch mode virtual
```

When the two switches are brought online, they proceed with VSL initialization and initialize their respective VSL ports. The two switches communicate with each other and determine active and standby roles. This exchange of information is evident through the following console messages:

<pre>System detected Virtual Switch configuration... Interface TenGigabitEthernet 1/5/4 is member of PortChannel 1 Interface TenGigabitEthernet 1/5/5 is member of PortChannel 1 <snip> 00:00:26: %VSL_BRINGUP-6-MODULE_UP: VSL module in slot 5 switch 1 brought up Initializing as Virtual Switch active</pre>	<pre>System detected Virtual Switch configuration... Interface TenGigabitEthernet 2/5/4 is member of PortChannel 2 Interface TenGigabitEthernet 2/5/5 is member of PortChannel 2 <snip> 00:00:26: %VSL_BRINGUP-6-MODULE_UP: VSL module in slot 5 switch 2 brought up Initializing as Virtual Switch standby</pre>
---	--

After the VSL is initialized and the Cisco Virtual Switching System becomes active, you may notice that the console is active only for the active virtual switch and has been disabled for the standby virtual switch:

<pre>00:08:01: SW1_SP: Card inserted in Switch_number = 2, physical slot 3, interfaces are now online VSS > VSS>en VSS#</pre>	<pre>00:01:43: %CRYPTO-6-ISAKMP_ON_OFF: ISAKMP is OFF 00:01:43: %CRYPTO-6-ISAKMP_ON_OFF: ISAKMP is OFF VSS-sdby> Standby console disabled</pre>
---	--

Although not required, it is possible to verify that all modules have been automatically provisioned and their module types stored in the configuration by issuing the following command on the active virtual switch:

```
VSS#sh run | begin module provision
module provision switch 1
slot 1 slot-type 254 port-type 31 number 2 port-type 61 number 1 port-type 60
number 2 virtual-slot 17
slot 2 slot-type 148 port-type 60 number 4 virtual-slot 18
slot 3 slot-type 147 port-type 61 number 48 virtual-slot 19
!
module provision switch 2
slot 1 slot-type 254 port-type 31 number 2 port-type 61 number 1 port-type 60
number 2 virtual-slot 33
slot 2 slot-type 148 port-type 60 number 4 virtual-slot 34
slot 3 slot-type 147 port-type 61 number 48 virtual-slot 35
```

Modules are provisioned in the configuration to allow for parsing, even if they are not present in the chassis. This situation occurs when one of the member switches is not yet online but the configuration needs to be parsed.

With the following command you can determine that the Cisco Virtual Switching System is now operating and that the two switches are acting as a single, logical network node.

```
VSS#show switch virtual
Switch mode : Virtual Switch
Virtual switch domain number : 100
Local switch number : 1
Local switch operational role: Virtual Switch Active
Peer switch number : 2
Peer switch operational role : Virtual Switch Standby
```

If the conversion process is performed using software release 12.2(33)SX13 or newer, it is complete once the two supervisors reach the SSO Standby Hot redundancy mode. If the conversion is performed using a software release prior to 12.2(33)SX13, there is one more critical step to perform in order to finalize the conversion.

Again, this final, critical step is applicable only for a first-time conversion, and only applicable to systems converted using a software release prior to 12.2(33)SX13.

During the conversion process, the configuration of the standby virtual switch (in this case, Switch 2) is cleared, including the configuration of the two VSL interfaces on the switch. If the switch were to reload at this point it would not have the information available to determine which interfaces to use for VSL communication. Therefore the configuration for the VSL interfaces on the standby switch must be applied, or merged from the active switch configuration. In order to facilitate this information to be repopulated again, you must complete Step 4.

Step 4. Finalize the Virtual Switch Conversion

When the standby virtual switch is in SSO hot mode, you must execute the following command to automatically configure the standby virtual switch configuration on the active virtual switch:

```
VSS#switch accept mode virtual
This command will bring in all VSL configurations from the standby switch and
populate it into the running configuration.
```

In addition the startup configurations will be updated with the new merged configurations.

```
Do you want proceed? [yes/no]: yes
Merging the standby VSL configuration. . .
Building configuration...
[OK]
```

This command prompts you to accept all standby virtual switch VSL-related configurations, and also updates the startup configuration with the new merged configurations. Note that only VSL-related configurations are merged with this step; all other configurations will be lost and require manual intervention.

If when entering this command running a 12.2(33)SX13 or newer software release, the command returns a notification that this step is no longer necessary.

```
VSS#
Core1#switch accept mode virtual
This command is no longer required since standby VSL configuration merge is done automatically.
VSS#
```

Operational Management

Management of the system as a whole changed with the advent of the Cisco Virtual Switching System. The fundamental concept of a switching system has evolved from a single physical entity managed separately to multiple physical entities that are managed as a single system. The following section examines areas such as console management, in-band (Telnet or SSH) management, SNMP and MIB changes, effects of NVRAM, NetFlow features, Switch Port Analyzer (SPAN), Embedded Event Manager (EEM), and CiscoWorks LAN Management System (LMS) management.

Console Management

After the two individual switches are converted into a Virtual Switching System, the console access is restricted to only the active virtual switch. In this case you can handle all configuration, monitoring, and troubleshooting under a single interface. The console output into the standby virtual switch indicates that the console is disabled for general administrative purposes.

Figure 12. Active and Standby Consoles

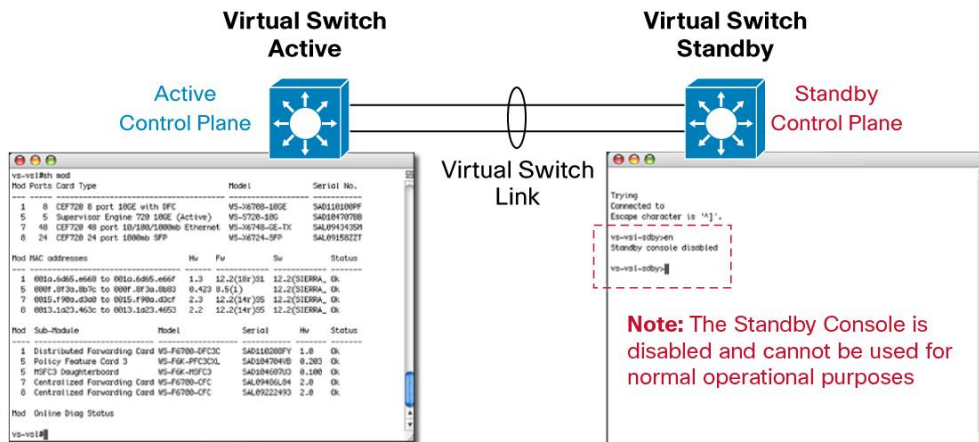

If a switchover occurs and switch 2 becomes the active virtual switch, the console becomes active on that supervisor engine.

Interface Numbering

After conversion to a Virtual Switching System, the interface numbering changes from a traditional scheme:

```
<INTERFACE_TYPE> <MODULE>/<PORT>
```

To a new 3-number scheme:

```
<INTERFACE_TYPE> <SWITCH_ID>/<MODULE>/<PORT>
```

This new naming scheme allows a single configuration file to uniquely address the physical interfaces on both chassis that are part of the same virtual switch domain.

```
vss#sh ip interface brief
Interface IP-Address OK? Method Status Protocol
Vlan1 unassigned YES NVRAM administratively down down
Vlan10 192.168.10.1 YES NVRAM up up
Vlan20 192.168.20.1 YES NVRAM up up
Loopback0 3.3.3.3 YES NVRAM up up
Port-channel1 unassigned YES NVRAM up up
Port-channel2 unassigned YES NVRAM up up
Port-channel10 unassigned YES unset up up
Port-channel20 unassigned YES unset up up
Te1/1/1 unassigned YES unset up up
Te1/1/2 unassigned YES NVRAM administratively down down
Te1/1/3 unassigned YES NVRAM administratively down down
Te1/1/4 unassigned YES NVRAM administratively down down
Te1/1/5 unassigned YES NVRAM administratively down down
```

File-System Naming

To facilitate the ability to uniquely identify multiple file systems on each supervisor engine or module across the Cisco Virtual Switching System, a new role-independent file-system naming scheme has been implemented:

```
SW<SWITCH_ID>-SLOT<MODULE>-<FILESYSTEM>:
```

This naming scheme allows all unique file systems to be addressed and identified across the entire virtual switch domain, regardless of supervisor-engine redundancy state:

```
vss#dir sw1-slot?
sw1-slot1-dfc-bootflash: sw1-slot5-const_nvram: sw1-slot5-disk0:
sw1-slot5-nvram: sw1-slot5-sup-bootdisk: sw1-slot5-sup-
bootflash:
sw1-slot7-dfc-bootflash: sw1-slot8-dfc-bootflash:
vss#dir sw2-slot?
sw2-slot1-dfc-bootflash: sw2-slot5-bootflash: sw2-slot5-
const_nvram:
sw2-slot5-disk0: sw2-slot5-nvram: sw2-slot5-sup-
```

```
bootdisk:
sw2-slot5-sup-bootflash: sw2-slot7-dfc-bootflash: sw2-slot8-dfc-
bootflash:
```

You can still use the existing file-system naming scheme, but you need to determine the role of the switch (active or standby) before you access the file systems.

Reloading the Cisco Virtual Switching System and Its Members

It may sometimes be desirable to reload the entire system or to reset individual members of the Virtual Switching System. You can perform these tasks through the console of the active virtual switch.

Reloading the Cisco Virtual Switching System

If you need to reload the entire Cisco Virtual Switching System (both active virtual switch and standby virtual switch), the following command achieves this reload:

```
vss#reload
Proceed with reload? [confirm]
```

Reloading a Member of the Cisco Virtual Switching System

It may be more desirable to reload a member of the Cisco Virtual Switching System rather than the entire system. You can accomplish this reloading in multiple ways.

You can reset the active virtual switch in two ways. First, you can issue the command **redundancy force-switchover**, which essentially forces a SSO or RPR switchover from active to standby, reloading the previous active virtual switch in the process:

```
vss#redundancy force-switchover
```

This will reload the active unit and force switchover to standby[confirm]

```
Preparing for switchover.
```

You can also use the **redundancy reload shelf** command, where either Switch 1 or Switch 2 can be specified:

```
vss#redundancy reload shelf 1
Reload this shelf [confirm]
```

You also have two options to reset the standby virtual switch. First, you can use the same command as before, replacing the switch ID with the switch ID of the standby virtual switch:

```
vss#redundancy reload shelf 1
Reload the entire remote shelf[confirm]
Preparing to reload remote shelf
```

Alternatively, use the command **redundancy reload peer** to reload the standby virtual switch:

```
vss#redundancy reload peer
Reload peer [confirm]
Preparing to reload peer
```

High Availability

Central to the high-availability model of a Cisco Virtual Switching System are the concepts of NSF/SSO and RPR. The intricacies of these protocols are beyond the scope of this paper; you can find more information on these protocols in the Catalyst 6500 documentation materials as well as in the following white paper:

“Non-Stop Forwarding and Stateful Switchover on the Catalyst 6500”

http://www.cisco.com/en/US/prod/collateral/switches/ps5718/ps708/prod_white_paper0900aecd801c5cd7.html

The high-availability model of the system changes when you integrate two chassis together into a single network entity. In order to take advantage of the existing innovations in NSF/SSO technologies, Cisco Virtual Switching System has implemented a high-availability model that uses this redundancy framework for an inter-chassis environment (Figure 19).

Figure 13. Interchassis NSF/SSO in a Cisco Virtual Switching System Environment

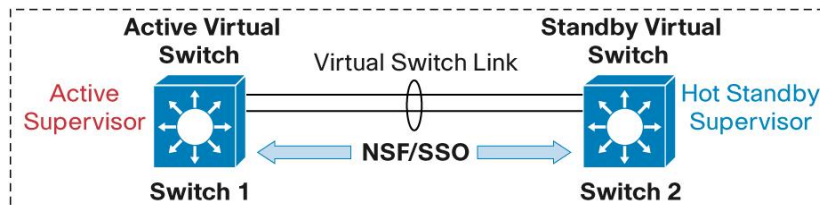

In an SSO system, “high availability-aware” protocols and features may synchronize events and state information from the active supervisor engine to the hot-standby supervisor engine. From a redundancy framework viewpoint, the active supervisor engine acts as a server, whereas the standby supervisor engine acts as the client. Information that is “high availability-aware” will be statefully synchronized between these entities. In the event of a failover, the standby supervisor engine does not need to relearn this information, resulting in a minimal amount of outage time.

As Figure 19 shows, the supervisor engine in the active virtual switch (Switch 1 in the figure) assumes the role as the active supervisor engine, whereas the supervisor engine in the standby virtual switch (Switch 2) assumes the role as the hot-standby supervisor engine. You can verify this situation with the following command:

```
VSS#sh switch virtual redundancy
My Switch Id = 1
Peer Switch Id = 2
Last switchover reason = none
Configured Redundancy Mode = sso
Operating Redundancy Mode = sso
Switch 1 Slot 1 Processor Information :
-----
Current Software state = ACTIVE
Uptime in current state = 1 day, 19 hours, 30 minutes
Image Version = Cisco IOS Software, s72033_rp Software (s72033_rp-
ADVENTERPRISEK9_WAN_DBG-VM), Version 12.2(SIERRA_INTEG_070530) INTERIM SOFTWARE
Synced to V122_32_8_11, 12.2(32.8.11)SR on rainier, Weekly 12.2(32.8.11)SX85
Technical Support: http://www.cisco.com/techsupport
Copyright (c) 1986-2007 by Cisco Systems, Inc.
```

```

Compiled Thu 31-May-07 02:23 by kchristi
BOOT = sup-bootdisk:s72033-adventerprisek9_wan_dbg-vz.SIERRA_INTEG_070530,1;
CONFIG_FILE =
BOOTLDR =
Configuration register = 0x2102
Fabric State = ACTIVE
Control Plane State = ACTIVE
Switch 2 Slot 1 Processor Information :
-----
Current Software state = STANDBY HOT (switchover target)
Uptime in current state = 1 day, 19 hours, 30 minutes
Image Version = Cisco IOS Software, s72033_rp Software (s72033_rp-
ADVENTERPRISEK9_WAN_DBG-VM), Version 12.2(SIERRA_INTEG_070530) INTERIM SOFTWARE
Synced to V122_32_8_11, 12.2(32.8.11)SR on rainier, Weekly 12.2(32.8.11)SX85
Technical Support: http://www.cisco.com/techsupport
Copyright (c) 1986-2007 by Cisco Systems, Inc.
Compiled Thu 31-May-07 02:23 by kchristi
BOOT = sup-bootdisk:s72033-adventerprisek9_wan_dbg-vz.SIERRA_INTEG_070530,1;
CONFIG_FILE =
BOOTLDR =
Configuration register = 0x2102
Fabric State = ACTIVE
Control Plane State = STANDBY

```

As this output indicates, if a failure occurs in the active supervisor engine or the active virtual switch, a SSO switchover is invoked, and the hot-standby supervisor engine in Switch 2 assumes the role as the active supervisor engine for the Cisco Virtual Switching System. This switchover should take approximately 50 ms.

Intrachassis Availability

The initial release of the Cisco Virtual Switching System supports only a single supervisor per chassis. If a second, or redundant, supervisor is installed in an individual chassis, the redundant supervisor will not fully boot, and will stop the boot process at the ROMMON stage. In this configuration, any device connected to the chassis in a single-homed, or single-attach, manner must rely on the availability of the single supervisor. Therefore, the recommendation for connecting to the VSS is to always dual-attach devices.

As a result of the single supervisor per chassis support, the recovery period for replacing a failed supervisor module is undeterministic in that the recover process requires manual intervention in order to install and initialize a new supervisor in the chassis.

Beginning in the 12.2(33)SX14 software release, Quad-Sup Uplink Forwarding is supported. This allows for a redundant supervisor to fully boot Cisco IOS, thereby providing a deterministic recovery option for redundant supervisors in a VSS chassis.

Quad-Sup Uplink Forwarding

Quad-Sup Uplink Forwarding is a supervisor redundancy feature developed just for the Virtual Switching System. This feature allows the In-chassis standby supervisor to fully boot Cisco IOS and provide full functionality of its uplink ports. In addition, the supervisor will perform some basic synchronization with the Active supervisor in the

local chassis. From the local chassis perspective, whichever supervisor boots first will become the “In-chassis Active” supervisor, while the second supervisor will become the “In-chassis Standby” supervisor. See Figure 14

Figure 14. Virtual Switching System with Quad-Sup Uplink Forwarding

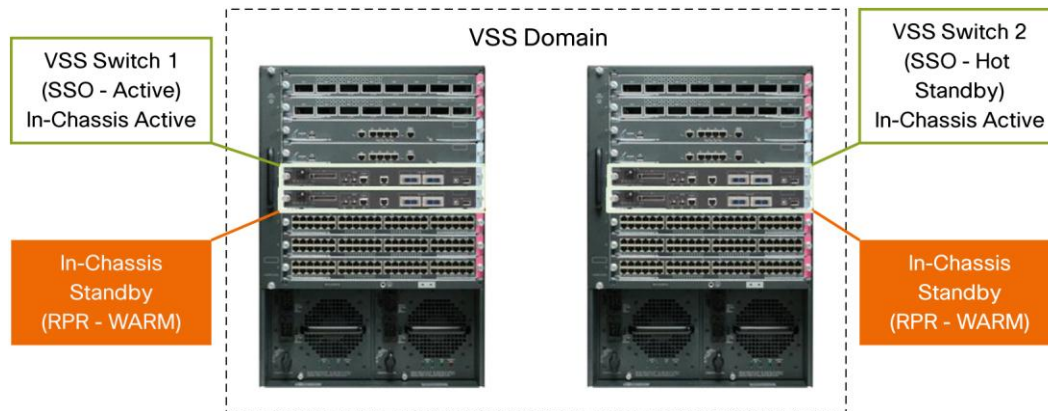

With the In-chassis Standby supervisor fully booted, the uplink ports are fully operational. They can be used as part of the VSL port-channel interfaces or other connectivity, just like ports on any other line card.

Note: Quad-Sup Uplink Forwarding is supported on Supervisor720-10G-based systems. Quad-Sup Uplink forwarding is not supported with Sup2T based systems. The Sup2T will support VSS-based supervisor redundancy in a future software release.

RPR-WARM Redundancy Mode

The In-chassis Standby supervisor runs a new redundancy mode called “RPR- Warm,” stated “RPR minus Warm”. The RPR- Warm redundancy mode is only available in the Virtual Switching System.

In addition to fully booting the in-chassis standby supervisor and providing fully operational uplink ports, the RPR- Warm redundancy mode also provides synchronization of the necessary information to allow the In-chassis Standby supervisor to reload and take over as the in-chassis active supervisor if needed. The RPR- Warm redundancy mode synchronizes the following crucial variables and data structures:

- Startup-config
- Vlan.dat
- BOOT ROMMON variable
- CONFIG_FILE ROMMON variable
- BOOTLDR ROMMON variable
- DIAG ROMMON variable
- SWITCH_NUMBER ROMMON variable

It is important to note that the RPR- Warm redundancy mode is not a stateful redundancy mode, as it applies to the local chassis. In other words, if the in-chassis active supervisor fails, the In-chassis standby supervisor will detect the failure and reload the local chassis. Subsequently, the former in-chassis standby supervisor will boot as the in-chassis active supervisor.

During the local chassis reload, the line cards will also reload. For devices connected to the Virtual Switching System in a dual-homed manner using a multi-chassis EtherChannel connection or using Layer 3 Equal Cost Multipath links, only the interfaces attached to the chassis performing the reload will be affected. Based on the peer devices ability to detect the loss of link on the interfaces associated with reloading chassis, traffic will switched to the remaining active chassis in the Virtual Switching System. Typically for multichassis EtherChannel or Layer 3 Equal Cost links, this is a hardware-based subsecond convergence event.

In-Chassis Standby Boot Process

The boot process for the second supervisor installed in VSS chassis is different from the boot process for a second supervisor in a standalone chassis. Early in the boot process of both scenarios, the supervisor will perform a role negotiation with the existing supervisor in the chassis. Once the supervisor determines that it will become the standby supervisor for the chassis, it will detect if the system is configured for the VSS. If the VSS configuration is detected, the supervisor will use a boot process to reach the RPR-WARM redundancy mode.

As shown in Figure 15, the second supervisor proceeds to boot to the RPR-WARM redundancy mode by loading a different Cisco IOS image. The new software image is specifically developed for a supervisor module operating as the VSS in-chassis standby role. The new image is called the “Sup-LC” image, as in Supervisor-Line Card. The Sup-LC image file is extracted out of the image already running on the supervisor in much the same way as a line card extracts its image file from the Cisco IOS image running on the active supervisor. Therefore, there are no additional requirements to copy a separate image to the file system of the switch.

Once the supervisor successfully loads the Sup-LC image, the supervisor will primarily operate as DFC-enabled line card. In addition, the supervisor will perform synchronization of important supervisor subsystems so that if needed the supervisor may reload and assume the role of the in-chassis active supervisor.

Figure 15. Boot Process for the Redundant Supervisor in a VSS Chassis

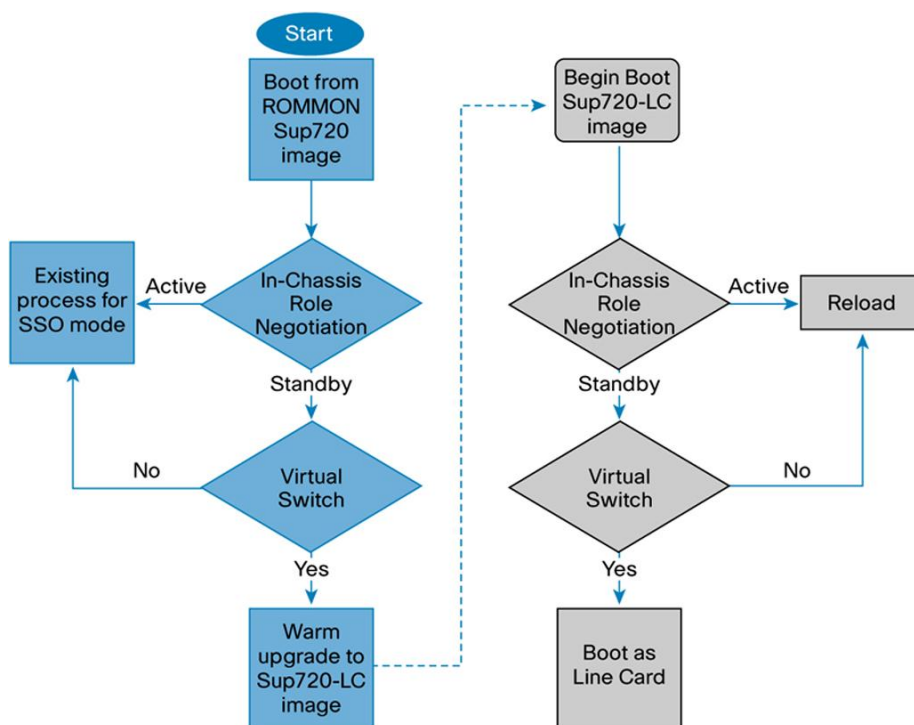

The only requirement to support Quad-Sup Uplink Forwarding is that both supervisor modules must be configured to boot the 12.2(33)SX14 or newer software version. The installation process for the redundant supervisor assumes that the in-chassis active supervisor is already configured and converted to the virtual switching mode.

Figure 16 shows the console output stage. This is where the redundant supervisor has detected the virtual switch configuration from the in-chassis active supervisor, and subsequently extracts the Sup-LC image file and start to boot as the In-chassis standby.

Figure 16. [[Need Caption]]

```
System detected Virtual Switch configuration...
Interface TenGigabitEthernet 2/5/4 is member of PortChannel 2
Interface TenGigabitEthernet 2/5/5 is member of PortChannel 2

*Apr  5 20:27:50.747: %SYS-3-LOGGER_FLUSHING: System pausing to ensure console debugging
output.

Firmware compiled 02-Mar-10 17:41 by integ Build [100]

*Apr  5 20:27:50.747: %PFREDUN-6-STANDBY: Initializing as STANDBY processor for this
switch!!!!!!!!!!!!!!!!!!!!!!!!!!!!!!!!!!!!!!!!!!!!!!!!!!!!!!!!!!!!!!!!!!!!!!!!!!!!!!
!!!!!!!!!!!!!!!!!!!!!!!!!!!!!!!!!!!!!!!!!!!!!!!!!!!!!!!!!!!!!!!!!!!!!!!!!!!!!!
!!!!!!!!!!!!!!!!!!!!!!!!!!!!!!!!!!!!!!!!!!!!!!!!!!!!!!!!!!!!!!!!!!!!!!!!!!!!!!
!!!!!!!!!!!!!!!!!!!!!!!!!!!!!!!!!!!!!!!!!!!!!!!!!!!!!!!!!!!!!!!!!!!!!!!!!!!!!!
!!!!!!!!!!!!!!!!!!!!!!!!!!!!!!!!!!!!!!!!!!!!!!!!!!!!!!!!!!!!!!!!!!!!!!!!!!!!!!
Decompressing the image :
#####
#####
# [OK]

Launching the SPLC image!
      Restricted Rights Legend
```

Once the in-chassis standby has fully loaded the Sup-LC image file, the supervisor will initialize itself primarily as a DFC-enabled line card. The Sup-LC image file runs on the supervisor switch processor. Therefore the console interface will appear as DFC line card as well. The redundancy mode of the supervisor module can be monitored using the existing show commands.

Figure 17. Abbreviated Output From the “show switch virtual redundancy” CLI with Quad-Sup Uplink Forwarding Enabled

```
C6500-VSS#show switch virtual redundancy
My Switch Id = 1
Peer Switch Id = 2
Last switchover reason = none
Configured Redundancy Mode = ss0
Operating Redundancy Mode = ss0

Switch 1 Slot 5 Processor Information :
-----
Current Software state = ACTIVE
Uptime in current state = 6 minutes
Image Version = Cisco IOS Software, s72033_rp, Software (s72033_rp-ADVIPSERVICESK9_WAN_DBG-M), Version
Copyright (c) 1986-2010 by Cisco Systems, Inc.
Compiled Thu 11-Mar-10 00:14 by inteq
BOOT = sup-bootdisk:s72033-advipservicesk9_wan_dbg-mz.122-32.8.11.SX354_qdb.12;
CONFIG_FILE =
BOOTLDR =
Configuration register = 0x2102
Fabric State = ACTIVE
Control Plane State = ACTIVE

Switch 1 Slot 6 Processor Information :
-----
Current Software state = RPR-Warm
Uptime in current state = 4 minutes
Image Version = Cisco IOS Software, s72033_lc, Software (s72033_lc-SPDBG-M), Version 12.2(32.8.11)SX354_qdb
Copyright (c) 1986-2010 by Cisco Systems, Inc.
Compiled Thu 11-Mar-10 00:06 by inteq
BOOT = bootdisk:s72033-advipservicesk9_wan_dbg-mz.122-32.8.11.SX354_qdb.12;
CONFIG_FILE =
BOOTLDR =
Configuration register = 0x2102
Fabric State = RPR-Warm
Control Plane State = RPR-Warm

!
(remaining output removed for brevity)
C6500-VSS#
```

Configuration Synchronization

When the redundancy-framework progression between the active supervisor engine and standby supervisor engine is reached, the configuration is synchronized between active virtual switch and standby virtual switch. The configuration file contains the configuration for the entire Cisco Virtual Switching System, and overwrites the configuration that exists on the standby virtual switch. Both the bulk configuration synchronization and the incremental configuration synchronization are sent through internal control messages across the VSL. As a result, the configuration in the standby virtual switch NVRAM is overwritten.

Virtual Switch Priorities and Switch Preemption

Because the Cisco Virtual Switching System consists of two chassis merged into a single entity, you can designate a particular physical switch to prefer an active role, while its peer prefers the standby role. This designation is usually determined by the following by default:

If switches are initiated at different times, then the switch that is **initiated first** becomes the active virtual switch.

If the switches are initiated simultaneously, the switch with the **lower switch ID** becomes the active virtual switch.

You can alter the default behavior by using the Virtual Switch Priorities feature and the Switch Preemption function.

Virtual Switch Priorities

Virtual Switch Priorities are assigned to each member of the Cisco Virtual Switching System under the Virtual Switch Configuration mode. By influencing the weighting of the priorities of each switch, you can deterministically define which physical switch will prefer the active virtual switch role or the standby virtual switch role.

A sample configuration follows:

```
vss#conf t
Enter configuration commands, one per line. End with CNTL/Z.
vss(config)#switch virtual domain 10
```

```

vss(config-vs-domain)#switch 1 priority 110
*Jul 7 08:59:11.913: %VSLP-SW1_SPSTBY-5-RRP_RT_CFG_CHANGE: Configured priority
value
is different from operational value.
Change will take effect after config is saved and switch is reloaded.
vss(config-vs-domain)#switch 2 priority 100
vss(config-vs-domain)#^Z
vss#

```

Notice from this configuration that the higher-priority value (110) assumes the active virtual switch role and the default priority is set to 100 (Figure 18).

Figure 18. Virtual Switch Priorities

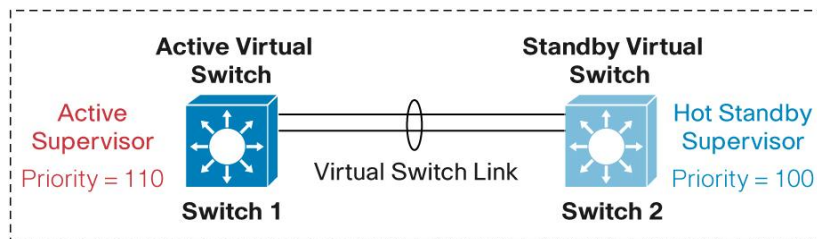

After you save the configuration, you can verify the roles of each virtual switch member with the following command:

```

vss#sh switch virtual role
Switch Switch Status Preempt Priority Role Session ID
Number Oper (Conf) Oper (Conf) Local Remote
-----
LOCAL 1 UP FALSE(N) 110(110) ACTIVE 0 0
REMOTE 2 UP FALSE(N) 100(100) STANDBY 6179 1085
In dual-active recovery mode: No

```

Note that the switch priorities affect role determination if both virtual switches are initiated simultaneously. If either switch (regardless of priority) is initiated prior to the subsequent switch, it always assumes the role of the active virtual switch. This behavior changes only if the Switch Preemption feature is configured.

Switch Preemption

As mentioned previously, you can determine virtual switch roles by boot order, switch ID, and switch priorities. However, after you determine the roles, you cannot change them without manual intervention. It may be desirable, however, to always configure a particular physical switch to assume the active virtual switch role. You can achieve this configuration with the Switch Preemption feature.

Switch Preemption works by comparing the Virtual Switch Priorities of the two individual switches after they are both brought online. If the virtual switch with the higher priority has the Switch Preemption feature configured and the current role of the higher-priority virtual switch is in standby mode, the current active virtual switch performs a SSO switchover after a preconfigured period of time, so that the virtual switch with the higher switch priority takes over as the active virtual switch (Figure 19).

Figure 19. Virtual Switch Preemption

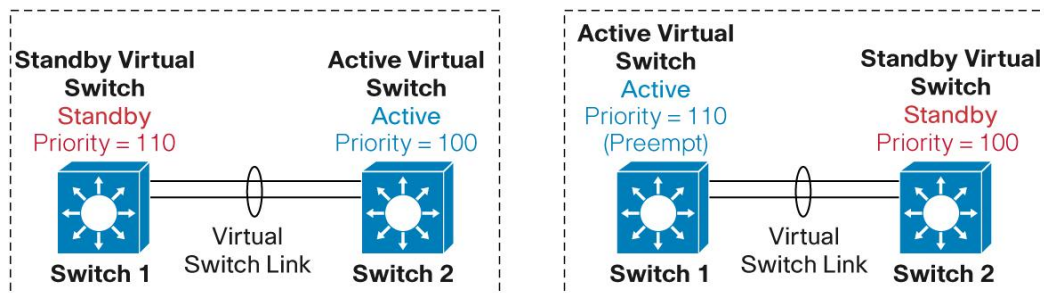

You should enable Switch Preemption only on the switch that has the higher switch priority. With the following command, you can enable this function under the virtual switch configuration mode. You can specify an optional timer value from 5 to 20 minutes, where this number represents the number of minutes the current active virtual switch waits after it establishes communication with the peer standby virtual switch through the VSL. The default and minimum time is set to 5 minutes. This timer is important, because it takes a variable amount of time after VSL initialization to initialize the remaining modules and establish network connectivity.

```
vss#conf t
Enter configuration commands, one per line. End with CNTL/Z.
vss(config)#switch virtual domain 10
vss(config-vs-domain)#switch 2 preempt 7
vss(config-vs-domain)#^Z
vss#
```

Use the following command to verify the configuration:

```
vss#show switch virtual role
Switch Switch Status Preempt Priority Role Session ID
Number Oper(Conf) Oper(Conf) Local Remote
-----
LOCAL 1 UP FALSE(N) 100(100) ACTIVE 0 0
REMOTE 2 UP TRUE (Y*) 120(120) STANDBY 1170 1366
Standby operational preempt timer(switch 2): 7 minutes
Standby will takeover as active in approx. : 4 minutes
Standby configured preempt timer(switch 2): 7 minutes
In dual-active recovery mode: No
```

Preemption should only be configured if there is a compelling requirement to do so. If preemption is enabled, the convergence time will be longer due to the fact that the switch will experience an additional reload. This additional reload is necessary, in order for the new switch to go from an active to a standby state.

First Hop Redundancy Protocols

First Hop Redundancy Protocols (Hot Standby Router Protocol [HSRP], Gateway Load Balancing Protocol [GLBP], and Virtual Router Redundancy Protocol [VRRP]) provide default gateway redundancy for devices when there are two or more redundant routing nodes, but the attached devices are not learning the network topology through Layer 3 routing protocols.

Typically, in a standalone environment, these First Hop Redundancy Protocols (FHRPs) are required to provide a single default gateway that is both redundant and highly available. These protocols typically designate an active forwarder for a given pair of Layer 3 interfaces by using respective hello protocols. Additionally, a separate instance of these hello protocols is run for each pair of interfaces for which the FHRP is configured.

In a Cisco Virtual Switching System environment, the use of FHRPs to provide default gateway redundancy has been obviated in most environments, because a single interface and router MAC address are shared across both virtual switches (Figure 20).

Figure 20. First Hop Redundancy Protocols

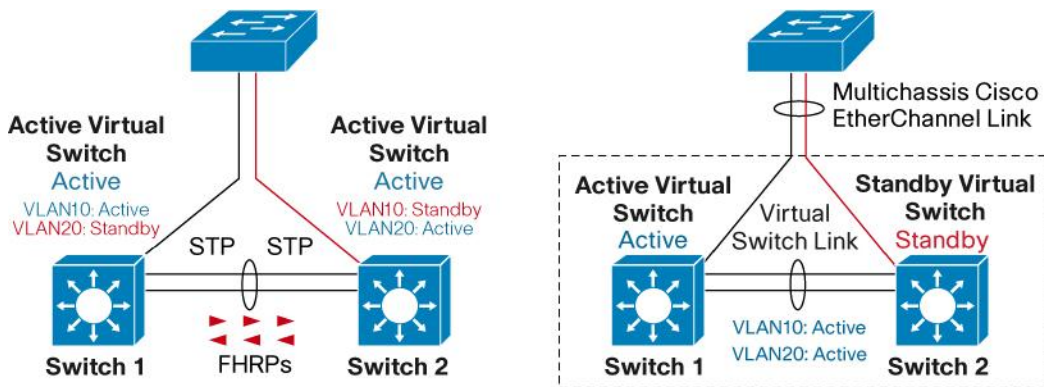

You can enable FHRP to another network device or Cisco Virtual Switching System with the FHRP frames redirected to the route processor of the active virtual switch for processing.

Failure Scenarios

With the VSS operating under normal, non-failure scenarios both chassis are actively forwarding data traffic, while one of the supervisor modules has negotiated to become the active control plane.

Active Supervisor Engine Failure

The standby supervisor engine can detect the failure of the active supervisor engine using one of the following methods:

Redundancy framework heartbeats sent across the VSL:

- VSL Protocol (VSLP)
- Cisco Generic Online Diagnostics (GOLD) failure event
- CDL-based hardware assistance
- Full VSL link down

Upon detecting the failure of the active supervisor, the hot-standby supervisor engine performs an SSO switchover and assumes the role of the active supervisor. An online insertion and removal (OIR) event is simulated for all modules in the previous active chassis to remove those cards from the running chassis inventory.⁵

⁵ If there is an in-chassis redundant supervisor engine installed or if the failed supervisor is capable of performing a reload, the failed chassis will be reloaded. After the reload, the former in-chassis standby supervisor will assume the role of the in-chassis active supervisor and proceed to boot chassis. This chassis will then become the VSS Hot Standby.

Figure 21. Three Main Stages of Supervisor Engine Switchover Event

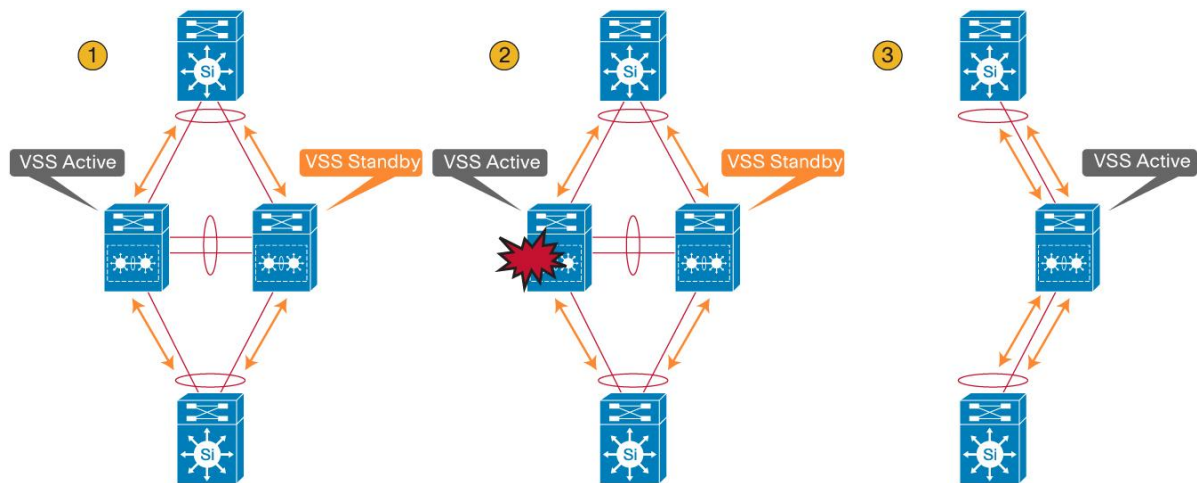

The effect on the data path is illustrated in Figure 26, using three main stages. In Stage 1, the virtual switch is operating under normal conditions with no failures. In Stage 2, the active supervisor failure occurs. At this time, the standby supervisor transitions to the active role and all of the modules from the previous active chassis are removed, effectively eliminating these interfaces from the data path. The third stage depicts all of the traffic transitioned to the new active chassis. During the transition, there is a disruption to the traffic that must transition away from the failed chassis. The duration of traffic disruption is determined by the time required to transition the role of the hot-standby supervisor engine to the active supervisor engine, and for the neighboring device to modify its path selection to the newly active chassis. If the vast majority of interfaces in the Cisco Virtual Switching System are multichassis Cisco EtherChannel links, this data disruption should have minimal effect on the network, and the disruption will be sub-second. Packets that are handled in the software path, however, will experience a slightly longer disruption. This failover should be similar to a typical SSO failure.

Hot-Standby Supervisor Engine Failure

You can detect the failure of the hot-standby supervisor engine in the following ways:

- Redundancy framework heartbeats sent across the VSL by the active supervisor
- Full VSL link-down situation
- Cisco Generic Online Diagnostics (GOLD) failure event

Upon detecting the failure of the hot-standby supervisor engine, the active supervisor engine simulates an OIR event for all modules in the standby virtual switch. This simulation is performed because the modules on the remote chassis have no connectivity, since VSL communication to the modules is proxied by the local supervisor-engine CPU.

The effect on the data path is that all line cards on the standby virtual switch are brought down. Assuming that adjacent devices are dual-homed to both the active virtual switch and standby virtual switch, only those flows being forwarded through the standby virtual switch are affected. The time to recovery depends on the mechanism used to detect the link failure (Cisco EtherChannel technology, Layer 3 load balancing, or Spanning Tree Protocol).

Upon detecting that the interface connected to the standby virtual switch has failed, traffic resorts to using the link to the active supervisor engine. Those data flows passing through the active virtual switch are not affected. The control plane is not affected because the control-plane functions remain on the active supervisor engine on the active virtual switch. The control plane experiences a removal of all of the standby virtual switch interfaces.

If the standby Virtual Switch contains an in-chassis standby supervisor, or, in the case of a single supervisor configuration, the hot-standby supervisor engine can reinitialize, it will reload. Upon bootup, the chassis proceeds with VSL initialization, and enters into standby chassis role with all its interfaces becoming operational again.

VSL Single-Link Failure

The failure of a single VSL link is discovered by the active supervisor engine, either through a link-down event or through the failure of periodic VSLP messages sent across the link to check the VSL link state (Figure 22).

Figure 22. VSL Link Failure

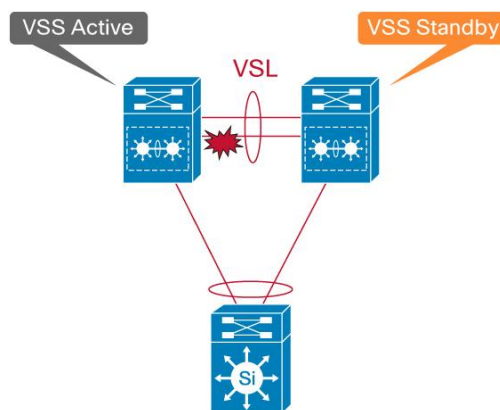

The index values, Result Bundle Hash, and fabric programming for selecting the VSL link will need to be automatically updated to reflect the removal of a link from the VSL. The active supervisor engine sends all of these messages.

Availability is not affected for those data flows that do not use the VSL. For those traffic flows that use the VSL, traffic outage is estimated to be approximately 50 to 100 ms. Notice that the duration of time is slightly faster than that for other multichassis Cisco EtherChannel links, since VSL always takes advantage of the adaptive Cisco EtherChannel load-balancing algorithm.

Single Link Failure Within a Multichassis Cisco EtherChannel Link

The failure of a single link within the multichassis Cisco EtherChannel link that is not the last link connecting to a chassis is recognized by either the multichassis Cisco EtherChannel link control protocol (PAgP or LACP) or the link-down event (Figure 23).

Figure 23. Link Fail Convergence

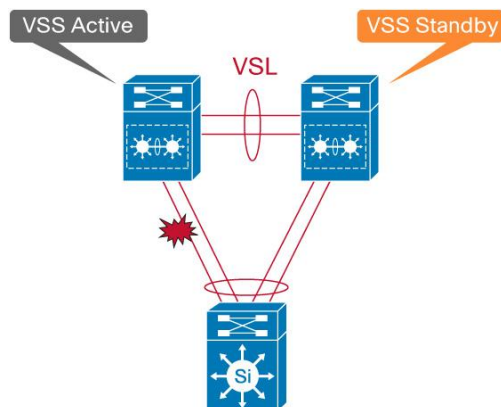

This link failure causes the RBH values to be redistributed among the remaining multichassis Cisco EtherChannel link ports in the local chassis, which is the same as a link failure in a standard Cisco EtherChannel link using a standalone Cisco Catalyst 6500. The endpoint (host, switch, router, etc.) on the other end of the multichassis Cisco EtherChannel link detects the link failure, and adjusts its load-balancing algorithms to avoid the failed link.

Availability is not affected for those data flows that do not use the failed link. For those traffic flows that use the failed link, the effect consists of the time it takes to detect the link failure and reprogram the indices within the system, estimated to be approximately 50 to 200 ms. You can achieve faster convergence time by using the adaptive Cisco EtherChannel load-balancing algorithm.

All Links to a Single Chassis Within the Multichassis Cisco EtherChannel Link Fail

When all of the links connecting to a single chassis that is part of the same multichassis Cisco EtherChannel link fail, the port bundle is converted from a multichassis Cisco EtherChannel link to a standard Cisco EtherChannel link, and is treated as a single-homed port. The links connecting to the peer chassis remain functional. From this point onward, all traffic from the failed link chassis destined for the Cisco EtherChannel link are sent to the remote chassis through the VSL (Figure 24).

Figure 24. Multi-link Failure Scenario

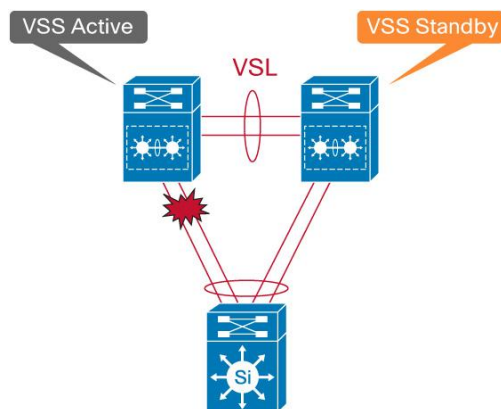

The control protocols managing the Cisco EtherChannel link (PAgP or LACP) continue to originate from the active supervisor engine and are sent out of the standby virtual switch ports through the VSL. The endpoint (host, switch, router, etc.) on the other end of the multichassis Cisco EtherChannel link detects the link failure and adjusts its load-balancing algorithms to avoid the failed link.

Availability is not affected for those data flows that do not use the failed link. For those traffic flows that use the failed link, the effect consists of the time it takes to detect the link failure and reprogram the indices within the system.

Complete VSL Failure (Dual Active)

The active supervisor engine discovers the failure of the VSL either through a link-down event or through the failure of the periodic VSLP messages sent across the member links to check the VSL link status. From the perspective of the active virtual switch chassis, the standby virtual switch is lost. The standby virtual switch chassis also views the active virtual switch chassis as failed and transitions to active virtual switch state through an SSO switchover. This scenario is known as a dual-active scenario (Figure 25).

Figure 25. Complete VSL Failure

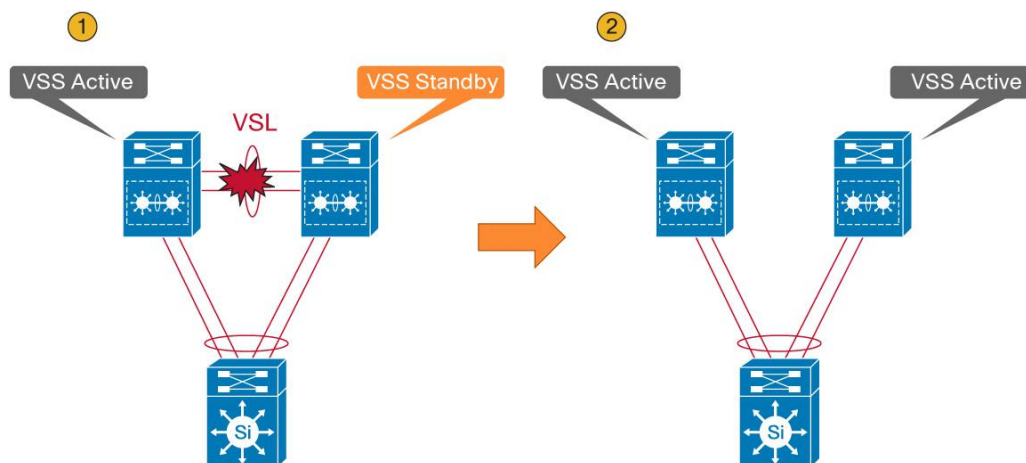

In this case, each virtual switch assumes the role as the active virtual switch, and each virtual switch controls only its local ports. However, there will most likely be some global Layer 2 and Layer 3 configuration, and the interface configuration for the multichassis Cisco EtherChannel links will be applied to both chassis. Duplication of this configuration can possibly have adverse effects to the network topology and traffic.

At Layer 3, any virtual interfaces (for example, port channels, SVIs, loopbacks, etc.) are duplicated on both chassis, causing duplicate IP addresses on the network. Any secure communications such as SSH and the cryptography feature set have the same set of keys on both chassis. At Layer 2, the spanning tree has the same bridge ID in both switches, possibly causing conflict. In general, this condition causes the same effect as when two routers or switches within a network contain the same configuration file.

To avoid this disruptive scenario, you should configure the VSL as a multiple-link port channel and spread it across all the available supervisor engines and modules within the chassis. You should also run the individual members of the VSL across separate physical paths when possible.

In some circumstances, this configuration may not be possible. Cisco Virtual Switching System has different mechanisms to address this dual-active scenario:

- Configuration of the VSL failure-detection feature
- Detection of a dual-active scenario
- Action taken to resolve the situation
- Recovery behavior upon restoring the VSL

Detection Mechanisms and Configuration

Because of the challenges to distinguish a remote chassis power failure and a VSL failure, each chassis attempts to detect its peer chassis, in order to avoid the dual-active scenario. In a dual-active scenario, it must be assumed that the VSL links cannot be used in any way to detect the failure. The only remaining options are to use alternative paths that may or may not exist between the two chassis.

Currently, there are currently three mechanisms for detecting a dual-active scenario:

- Enhanced PAgP
- Layer 3 BFD
- Fast Hello

Enhanced PAgP

With the introduction of Cisco Virtual Switching System in the first software release, an enhancement to the PAgP protocol (Enhanced PAgP or PAgP+) has been implemented to assist in the dual-active detection. A list of all software releases for respective switch platforms supporting Enhanced PAgP is included in Table 1 (Figure 26).

Figure 26. Dual-Active Detection Mechanisms

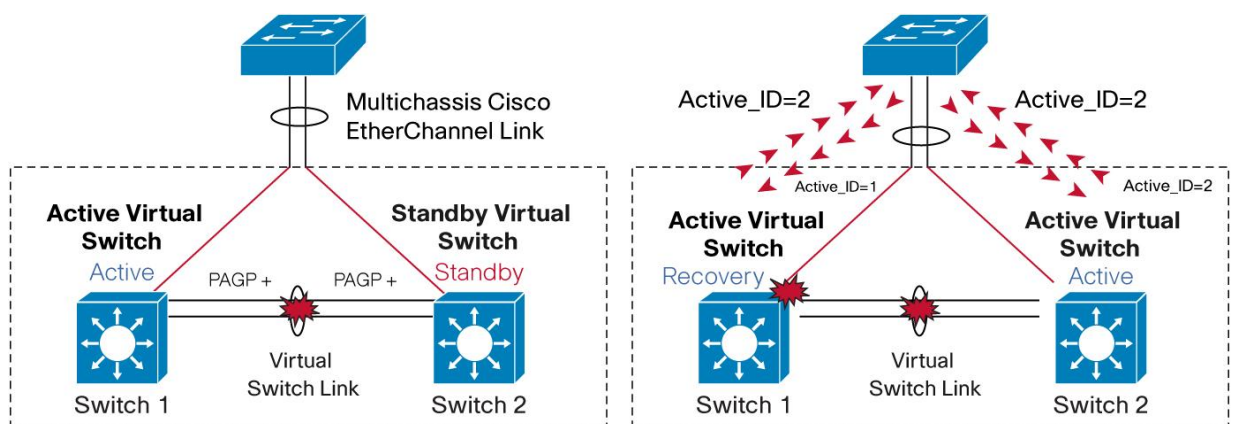

The result of this detection is that the standby virtual switch (Switch 2) always transitions to become an active virtual switch, and the active virtual switch (Switch 1) always enters into recovery mode.

Upon the detection of VSL going down on Switch 2, the switch will immediately transmit a PAgP message on all port channels enabled for Enhanced PAgP dual-active detection, with a Type-Length-Value (TLV) containing its own Active ID = 2. When the access switch receives this PAgP message on any member of the port channel, it detects that it has received a new active ID value, and considers such a change as an indication that it should consider Switch 2 to be the new active virtual switch. In turn, the access switch modifies its local active ID value to Active ID = 2, and immediately sends a message to both virtual switches on all members of the port channel with the new Active ID = 2 to indicate that it now considers Switch 2 to be the active virtual switch.

From this point onward, the access switch sends TLVs containing Active ID = 2 to the virtual switches in all its regularly scheduled PAgP messages.

Use the following commands to configure the Cisco Virtual Switching System to take advantage of dual-active detection using Enhanced PAgP:

```
vss#conf t
Enter configuration commands, one per line. End with CNTL/Z.
vss(config)#switch virtual domain 10
vss(config-vs-domain)#dual-active detection pagp
vss(config-vs-domain)#dual-active trust channel-group 20
vss(config-vs-domain)#
```

To verify the configuration and help ensure that Enhanced PAgP is compatible with its neighbors, issue the following command:

```
vss#sh switch virtual dual-active pagp
PAgP dual-active detection enabled: Yes
PAgP dual-active version: 1.1
Channel group 10 dual-active detect capability w/nbrs
Dual-Active trusted group: No
Dual-Active Partner Partner Partner
Port Detect Capable Name Port Version
Gi1/8/1 No SAL0802SHG 5/2 N/A
Gi2/8/1 No SAL0802SHG 5/1 N/A
Channel group 20 dual-active detect capability w/nbrs
Dual-Active trusted group: Yes
Dual-Active Partner Partner Partner
Port Detect Capable Name Port Version
Te1/1/1 Yes vs-access-2 Te5/1 1.1
Te2/1/1 Yes vs-access-2 Te5/2 1.1
```

Layer 3 BFD

If no Enhanced PAgP neighbors are available to assist in dual-active detection, another method is required to perform this function. Use of a dedicated Layer 3 direct link heartbeat mechanism between the virtual switches is an inexpensive way to determine whether or not a dual-active scenario has occurred (Figure 27).

Figure 27. Dual-Active Detection Using IP-BFD

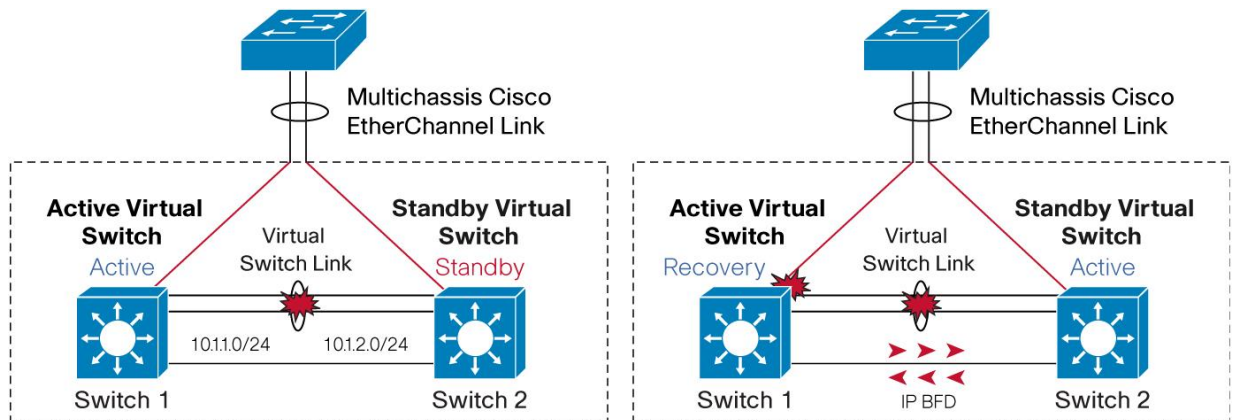

Bidirectional Forwarding Detection (BFD) assists in the fast detection of a failed VSL, natively bringing in the benefits that BFD offers, such as subsecond timers and pseudo-preemption. To take advantage of this feature, you must first configure BFD on the selected interfaces that will be participating in IP-BFD dual-active detection, noting that these interfaces must be directly connected to each other:

```
vss#conf t
Enter configuration commands, one per line. End with CNTL/Z.
vss(config)#int gig 1/5/1
vss(config-if)#ip address 10.1.1.1 255.255.255.0
vss(config-if)#bfd interval 100 min_rx 100 multiplier 50
vss(config-if)#no shutdown
vss(config-if)#int gig 2/5/1
vss(config-if)#ip address 10.1.2.1 255.255.255.0
vss(config-if)#bfd interval 100 min_rx 100 multiplier 50
vss(config-if)#no shutdown
vss(config-if)#exit
```

Note that in a Cisco Virtual Switching System environment, both interfaces are seen to be Layer 3 routed interfaces on the same logical router and hence require different network addresses even though they are directly connected together.

To enable IP-BFD for dual-active detection, use the following configuration:

```
vss(config)#switch virtual domain 10
vss(config-vs-domain)#dual-active detection bfd
vss(config-vs-domain)#dual-active pair interface gig1/5/1 interface gig2/5/1 bfd
adding a static route 10.1.2.0 255.255.255.0 Gi1/5/1 for this dual-active pair
adding a static route 10.1.1.0 255.255.255.0 Gi2/5/1 for this dual-active pair
vss#show switch virtual dual-active bfd
Bfd dual-active detection enabled: Yes
Bfd dual-active interface pairs configured:
interface-1 Gi1/5/1 interface-2 Gi2/5/1
```

Note that by configuring these commands, static routes are automatically added for the remote addresses and are installed in the Routing Information Base (RIB) only if a dual-active scenario occurs. As a result, no packets are forwarded between the switches through the heartbeat interfaces until the VSL is brought down.

When the VSL does go down, a unique internal MAC address (selected from the pool of MAC addresses reserved for the line card) is assigned for each of the local interfaces, and sending BFD heartbeat packets brings up BFD neighbors. If the standby virtual switch has taken over as active, a BFD “adjacency-up” event is generated, indicating that a dual-active situation has occurred.

Fast Hello Detection

With 12.2(33)SX1, a Fast Hello detection mechanism was introduced. This is similar to IP-BFD, as it is a dedicated direct link heartbeat between the VSS switches. However, Fast Hello is a L2 connection and you can configure up to 4 non-VSL links. The two chassis will periodically exchange Fast Hello heartbeat packets that contain the switch state. When the VSL fails, the Fast Hello packets are no longer received on each switch, thus indicating that a dual-active scenario has occurred (Figure 28).

Figure 28. Dual-Active Detection Using Fast Hello

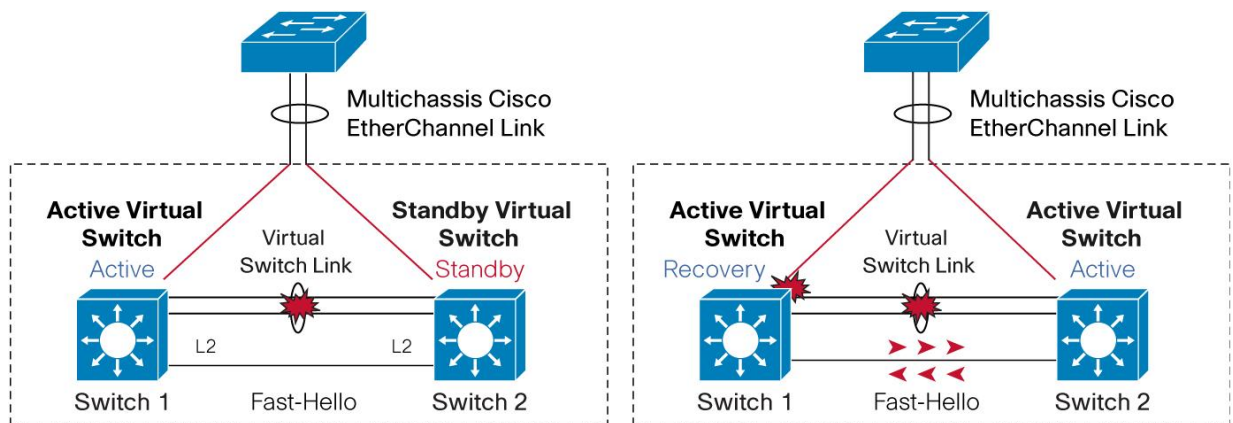

In order for Fast Hello to operate, the interfaces must be enabled with this protocol. Unlike IP-BFD, that only exchanges hello packets after the VSL fails, Fast Hello exchanges heartbeat messages throughout the period that the VSL remains up, thereby reducing the time it takes to detect the dual-active scenario.

```
vss(config)# interface fastethernet 1/2/40
vss(config-if)# dual-active fast hello
WARNING: Interface FastEthernet1/2/40 placed in restricted config mode. All
extraneous configs removed!
```

Up to four interfaces (directly connected) on each chassis can be configured. These interfaces must be physical interfaces, no logical ports (for example, SVI).

```
vss(config-if)# no shutdown
vss(config-if)# exit
vss(config)# exit
vss# show run interface fastethernet 1/2/40
interface FastEthernet1/2/40
no switchport
no ip address
```

```
dual-active fast hello
end
```

Once Fast Hello has been configured, the existing configuration on the interface will be automatically removed and will only be restricted for Fast Hello configurations. Also, UDLD will be disabled on Fast Hello pairs.

```
vss(config)# switch virtual domain 10
vss(config-vs-domain)# dual-active detection fast hello
vss(config-vs-domain)# exit
```

Action Upon Dual-Active Detection

Upon detecting the dual-active condition, the original active chassis enters into recovery mode and brings down all of its interfaces except the VSL and nominated management interfaces. This effectively removes the device from the network.

To nominate specific interfaces to be excluded from being brought down during dual-active detection recovery, use the following commands:

```
vss(config)#switch virtual domain 10
vss(config-vs-domain)#dual-active exclude interface gigabitEthernet 1/5/3
WARNING: This interface should only be used for access to the switch when in
dual-active recovery mode and should not be configured for any other purpose
vss(config-vs-domain)#dual-active exclude interface gigabitEthernet 2/5/3
WARNING: This interface should only be used for access to the switch when in
dual-active recovery mode and should not be configured for any other purpose
vss(config-vs-domain)#
```

To verify this configuration is correct, issue the following commands:

```
vss#sh switch virtual dual-active summary
Page dual-active detection enabled: Yes
Ip bfd dual-active detection enabled: Yes
Interfaces excluded from shutdown in recovery mode:
Gi1/5/3
Gi2/5/3
In dual-active recovery mode: No
```

You will see the following messages on the active virtual switch to indicate that a dual-active scenario has occurred:

```
*Jun 26 16:06:36.157: %VSLP-SW2_SPSTBY-3-VSLP_LMP_FAIL_REASON: Port 5/4: Link
down
*Jun 26 16:06:36.782: %VSLP-SW1_SP-3-VSLP_LMP_FAIL_REASON: Port 5/4: Link down
*Jun 26 16:06:36.838: %VSL-SW1_SP-5-VSL_CNTRL_LINK: vsl_new_control_link NEW VSL
Control Link 5/5
*Jun 26 16:06:37.037: %VSLP-SW1_SP-3-VSLP_LMP_FAIL_REASON: Port 5/5: Link down
*Jun 26 16:06:37.097: %VSL-SW1_SP-2-VSL_STATUS: ===== VSL is DOWN =====
```

The following messages on the standby virtual switch console indicate that a dual-active scenario has occurred:

```
*Jun 26 16:06:36.161: %VSL-SW2_SPSTBY-5-VSL_CNTRL_LINK: vsl_new_control_link NEW
VSL Control Link 5/5
```

```

*Jun 26 16:06:37.297: %VSLP-SW2_SPSTBY-3-VSLP_LMP_FAIL_REASON: Port 5/5: Link
down
*Jun 26 16:06:37.297: %VSL-SW2_SPSTBY-2-VSL_STATUS: ===== VSL is DOWN
=====
*Jun 26 16:06:37.301: %PFREDUN-SW2_SPSTBY-6-ACTIVE: Initializing as Virtual
Switch ACTIVE processor
*Jun 26 16:06:37.353: %SYS-SW2_SPSTBY-3-LOGGER_FLUSHED: System was paused for
00:00:00 to ensure console debugging output.
*Jun 26 16:06:37.441: %DUALACTIVE-SP-1-VSL_DOWN: VSL is down - switchover, or
possible dual-active situation has occurred

```

Recovery from Dual-Active Scenario

If a VSL flap occurs, the system recovers automatically. Upon a link-up event from any of the VSL links, the previous active supervisor engine that is now in recovery mode reloads itself, allowing it to initialize as the hot-standby supervisor engine.

If the peer chassis is not detected because the VSL is down again, the dual-active detection mechanism determines whether or not the peer chassis is active. If the peer chassis is detected, this event is treated as another VSL failure event, and the chassis once again enters into recovery mode.

When the VSL is restored, the following messages are displayed on the console and the switch in recovery mode (previous active virtual switch) reloads:

```

*Jun 26 16:23:34.877: %DUALACTIVE-1-VSL_RECOVERED: VSL has recovered during dual-
active situation: Reloading switch 1
*Jun 26 16:23:34.909: %SYS-5-RELOAD: Reload requested Reload Reason: Reload
Command.
<...snip...>
***
*** --- SHUTDOWN NOW ---
***
*Jun 26 16:23:42.012: %SYS-SW1_SP-5-RELOAD: Reload requested
*Jun 26 16:23:42.016: %OIR-SW1_SP-6-CONSOLE: Changing console ownership to switch
processor
*Jun 26 16:23:42.044: %SYS-SW1_SP-3-LOGGER_FLUSHED: System was paused for
00:00:00 to ensure console debugging output.
System Bootstrap, Version 8.5(1)
Copyright (c) 1994-2006 by cisco Systems, Inc.
<...snip...>

```

After the chassis reloads, it reinitializes and the supervisor engine enters into standby virtual switch mode. If Switch Preemption is configured to prioritize this chassis to become active, it assumes this role after the preempt timer expires.

Finally, traffic convergence associated with a VSL failure scenario involves the dual-active detection mechanisms, the recovery mode operations, and the restoration period, which involves a reload of the previously active VSS chassis. In each of the three previous stages, there is a possibility for some traffic disruption. Typically, the disruption will be similar to the NSF/SSO switchover scenarios described previously but other factors from the overall network design can have an impact as well. These include the types of connections to the VSS, either L2 or L3 Multichassis EtherChannels or Equal Cost Paths. For more detailed analysis on convergence times associated with the VSS failure scenarios please refer to following document:

Quality of Service

Quality of service (QoS) handling on the Cisco Catalyst 6500 Series switches can be separated into two distinct areas of responsibility: port-based QoS features and forwarding-engine (PFC or DFC) features. Both areas operate together to help ensure differentiated servicing of traffic throughout the system.

In a Cisco Virtual Switching System environment, proper QoS handling becomes even more important because of the following reasons:

- Control traffic between the two Cisco Virtual Switching System switches (active virtual switch and standby virtual switch) should be prioritized and not be dropped
- The existence of the VSL and multichassis Cisco EtherChannel links represents potential points of congestion that must be properly accounted for

Additionally, the nature of dual-homing logical connections across different chassis and forwarding engines represents a change in the way features such as policing and marking work. These features need to be properly accounted for.

VSL as a Congestion Point

From a system-level perspective, the VSL can be viewed as a backplane connection that bonds the two virtual switch chassis together into a single, logical entity. While provisions have been made to Cisco EtherChannel and Equal Cost Multipath (ECMP) hashing mechanisms (refer to the section “Cisco EtherChannel Concepts”), under certain circumstances (in the case of single-homed connections whether by design or if failures occur) it may be possible to oversubscribe the links that form the VSL.

VSL should always consist of at least 2 ports of 10 Gigabit Ethernet connections. However, because of hash inefficiencies, it may be possible to oversubscribe a single VSL member port. Therefore, correct prioritization needs to occur on the VSL.

Correct prioritization is accomplished by always provisioning the VSL as a link that is in trust-CoS mode, provisioning that not only maintains the internal differentiated services code point (DSCP) markings set by either ingress switch but also sets up default receive and transmit queues and properly assigns the appropriate colored frames to the correct queues (Figure 29).

Figure 29. Virtual Switch Link QoS

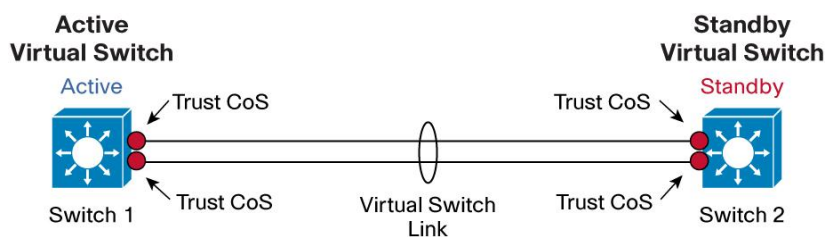

The following output shows that Port Channel 2 is configured as a VSL, and it has the QoS configuration of trust CoS programmed by default. Also note that removing or modifying this trust command is not permitted:

```
interface Port-channel2
no switchport
```

```

no ip address
switch virtual link 2
mls qos trust cos
end
vss#conf t
Enter configuration commands, one per line. End with CNTL/Z.
vss(config)#int po2
vss(config-if)#no mls qos trust cos
HWIF-QoS: QoS configs are not allowed on VSL Portgroup
vss(config-if)#mls qos trust dscp
HWIF-QoS: QoS configs are not allowed on VSL Portgroup

```

The following output shows that for a member port of the VSL, the relevant CoS-queue mappings have already been provisioned for both ingress and egress queues, even without QoS globally enabled:

```

vss#sh queueing int te2/5/4
Interface TenGigabitEthernet2/5/4 queueing strategy: Weighted Round-Robin
Port QoS is enabled
Trust state: trust COS
Extend trust state: not trusted [COS = 0]
Default COS is 0
Queueing Mode In Tx direction: mode-cos
Transmit queues [type = 1p3q4t]:
Queue Id Scheduling Num of thresholds
-----
01 WRR 04
02 WRR 04
03 WRR 04
04 Priority 01
WRR bandwidth ratios: 100[queue 1] 150[queue 2] 200[queue 3]
queue-limit ratios: 50[queue 1] 20[queue 2] 15[queue 3] 15[ Pri Queue]
queue tail-drop-thresholds
-----
1 70[1] 100[2] 100[3] 100[4]
2 70[1] 100[2] 100[3] 100[4]
3 100[1] 100[2] 100[3] 100[4]
queue random-detect-min-thresholds
-----
1 40[1] 70[2] 70[3] 70[4]
2 40[1] 70[2] 70[3] 70[4]
3 70[1] 70[2] 70[3] 70[4]
queue random-detect-max-thresholds
-----
1 70[1] 100[2] 100[3] 100[4]
2 70[1] 100[2] 100[3] 100[4]

```



```

3 100[1] 100[2] 100[3] 100[4]
WRED disabled queues:
queue thresh cos-map
-----
1 1 0
1 2 1
1 3
1 4
2 1 2
2 2 3 4
2 3
2 4
3 1 6 7
3 2
3 3
3 4
4 1 5
Queueing Mode In Rx direction: mode-cos
Receive queues [type = 2q4t]:
Queue Id Scheduling Num of thresholds
-----
01 WRR 04
02 WRR 04
WRR bandwidth ratios: 10[queue 1] 90[queue 2]
queue-limit ratios: 80[queue 1] 20[queue 2]
queue tail-drop-thresholds
-----
1 70[1] 80[2] 90[3] 100[4]
2 100[1] 100[2] 100[3] 100[4]
queue random-detect-min-thresholds
-----
1 40[1] 40[2] 50[3] 50[4]
2 100[1] 100[2] 100[3] 100[4]
queue random-detect-max-thresholds
-----
1 70[1] 80[2] 90[3] 100[4]
2 100[1] 100[2] 100[3] 100[4]
WRED disabled queues: 2
queue thresh cos-map
-----
1 1 0 1
1 2 2 3
1 3 4
1 4 6 7
2 1 5

```

```
2 2
2 3
2 4
<...snip...>
```

A restriction has been imposed, however, that does not permit you to modify QoS settings on the VSL ports in the initial release of software. Hence, you can modify only the default queue, drop threshold, and buffer depth settings.

```
vss(config)#int te2/5/4
vss(config-if)#priority-queue cos-map 1 2
HWIF-QOS: QoS configs are not allowed on VSL Portgroup
```

Additionally, policy maps used for classification or policing are also forbidden on the VSL and its respective members.

Control Traffic over VSL

Multiple types of control traffic must be parsed between the two virtual switches, including VSLP and other inband messages. These special control frames are tagged with a special bit internal to the system, indicating that they require specialized treatment, and are automatically assigned to the priority queue of the interface for expedited delivery. As a result, no extra configuration is required.

The priority queue is always serviced first, prior to any other Deficit Weighted Round Robin (DWRR) queues.

Using Supervisor Engine 720-10G VSS 10 Gigabit Ethernet Uplink Ports as VSL Interfaces

You can use the 10 Gigabit Ethernet uplink ports on the Supervisor Engine 720-10G VSS to form a VSL. In addition to the two 10 Gigabit Ethernet uplink ports, there are also three additional Gigabit Ethernet ports: two Small Form-Factor Pluggable (SFP) interfaces and a 10/100/1000 RJ-45 interface. You cannot use these ports as VSL interfaces.

If you use only the 10 Gigabit Ethernet ports, you can optimize the queue structure to take full advantage of an 8q4t queue structure on receive, and 1p7q4t queue structure on transmit. However, if you use both the Gigabit Ethernet interfaces and 10 Gigabit Ethernet interfaces concurrently, then the 10 Gigabit Ethernet interfaces take on the queue structure of the Gigabit Ethernet interfaces, which is 4q4t on receive and 1p3q4t on transmit.

If you want to use only the 10 Gigabit Ethernet ports, you must shut down the Gigabit Ethernet ports and globally configure an extra CLI on the system:

```
VSS(config)#mls qos 10g-only
Error: following ports have to be shut to enable 10g-only mode:
Gi1/5/1 Gi1/5/2 Gi1/5/3
Command Rejected!
VSS(config)#interface range gigabitEthernet 1/5/1 - 3
VSS(config-if-range)#shut
VSS(config-if-range)#exit
VSS(config)#mls qos 10g-only
HWIF-QOS: Queuing qos cfg (wrr-queue/rcv-queue/priority-queue) will be reset to
default on Supervisor Slot 5 interfaces!
VSS(config)#
```

```
VSS#sh interfaces tenGigabitEthernet 1/5/4 capabilities | include QoS
QoS scheduling: rx-(8q4t), tx-(1p7q4t)
QoS queueing mode: rx-(cos,dscp), tx-(cos,dscp)
```

Applying Policies

Classification or policing policies are applied to the system through the Modular QoS CLI (MQC) mechanisms, which use class maps and policy maps. Each policy map can use multiple class maps to make up a policy map, and you can define these policy classes for different types of traffic flows.

On the Cisco Catalyst 6500, you can define up to 255 class maps per policy map, with a total of 1024 class maps per system, implying that across the Virtual Switching System a maximum of 1024 class maps can be supported.

MQC in Cisco IOS Software allows the separation of class maps from policy maps and the separation of these maps from the application on an interface. The initial release of software also has a limitation in that it allows for only a limited number of interfaces to be indexed uniquely for QoS purposes. As a result, you can apply QoS policies only on Layer 3 interfaces (SVIs, physical interfaces, port channels, etc.) and on Layer 2 Cisco EtherChannel links.

In a Cisco Virtual Switching System, application of policies on physical Layer 2 interfaces is now supported in 12.2(33)SXI and above.

Policing

Policing is the process of inspecting whether traffic on a given port or within a VLAN has exceeded a predefined rate. If that traffic is out of profile (that is, the rate of the traffic stream exceeds the predefined rate), either excess data can be dropped or its priority value marked down.

Two types of policers are supported on the Cisco Catalyst 6500 Series switches: aggregate policers and microflow policers. Although you can implement both types, they are subject to different restrictions in a Cisco Virtual Switching System environment. The next section addresses some of these restrictions relating to policers.

Aggregate Policing

Aggregate policers limit the amount of traffic received or transmitted in or out a port. The aggregate policer applies to all traffic on a port or VLAN that matches a specified QoS ACL. If the aggregate policer is applied to a single interface, it counts all matching traffic (that matches the classifying ACL) coming into the interface toward the policer. If the aggregate policer is applied to a VLAN, then all of the matching traffic coming in any of the ports in that VLAN is counted toward the stated rate.

There are two forms of aggregate policers:

Per-interface aggregate policers: These policers are applied to an individual interface using the **police** command within a policy-map class. You can apply these map classes to multiple interfaces, but the policer polices each interface separately.

Named aggregate policers or shared aggregate: These policers are applied to a group of ports and police traffic across all interfaces cumulatively. Name aggregates are applied using the **mls qos aggregate police** command.

The policing function is typically handled by the ingress forwarding engine (either PFC or DFC). A critical restriction to implementing aggregate policers in a Cisco Virtual Switching System environment is the current lack of distributed aggregate policing capabilities across different forwarding engines. That is, if a policer is required to span across multiple forwarding engines, each forwarding engine keeps track of its own token-bucket quota and hence generally results in the under-policing of traffic. This situation usually manifests itself when applying policers on the following types of interfaces (Figure 30):

- VLAN interfaces that consist of member ports that belong to multiple forwarding engines
- Port-channel interfaces that consist of member ports that belong to multiple forwarding engines
- Shared aggregate policers that consist of member ports that belong to multiple forwarding engines

Figure 30. Aggregate Policing Within Cisco Virtual Switching System

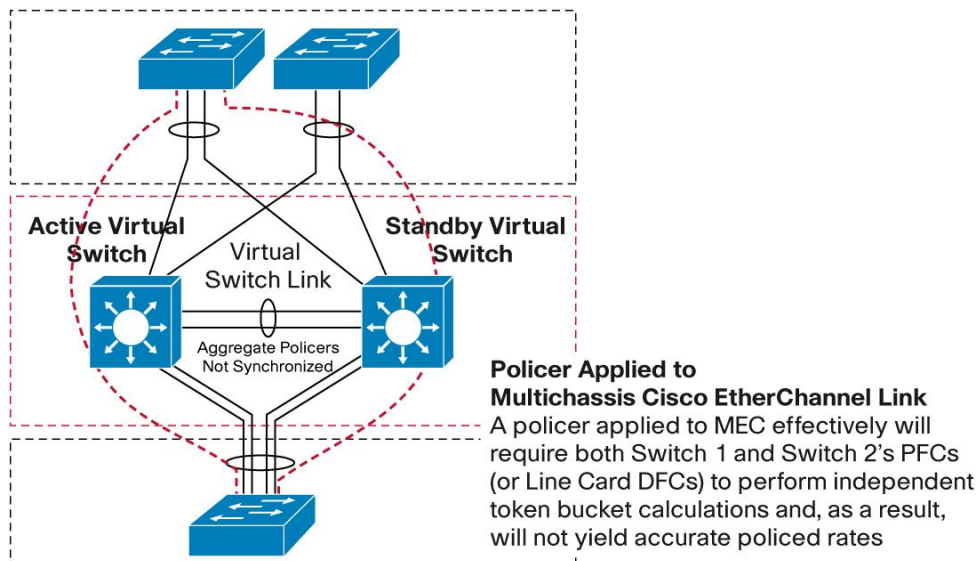

Microflow Policing and User-Based Rate Limiting

Microflow policing allows you to police individual traffic flows at a given rate. Depending on the flow mask used (whether it is a unique source or destination MAC address, source or destination IP address, or TCP/User Datagram Protocol [UDP] port numbers), you can use microflow policing to limit the amount of data sent or received for that flow on a port or VLAN basis. In the microflow definition, you can either drop packets that exceed the prescribed rate limit or have their DSCP value marked down.

User Based Rate Limiting (UBRL) is a form of microflow policing that also supports the policing of individual flows. The primary difference is that you can specify a source-only flow or destination-only flow, rather than the full source or destination address of the packet.

For both microflow policing and UBRL, the NetFlow table on either the PFC or DFC is used to track the individual flows, as well as maintain the flow statistics. Most importantly, it is used to track the rate of ingress traffic for each individual flow by implementing a separate token bucket for each NetFlow entry. Cisco Virtual Switching System also has the restriction that each forwarding engine is responsible for the calculation of each flow independently and cannot be synchronized across multiple forwarding engines.

As a result, only flows that always arrive on the same forwarding engine are policed correctly; otherwise they are underpoliced. Generally, this situation allows only the following flow masks for use on multichassis Cisco EtherChannel link interfaces:

- **Source and destination:** Source and destination IP address
- **Interface, source, and destination:** Input interface, source, and destination IP address
- **Full:** Source, destination IP address, IP, and TCP/UDP source and destination ports if present
- **Interface, full:** Input interface, source, destination IP address, IP, and TCP/UDP source and destination ports if present

As a result, UBRL does not yield the desired behavior if applied to multichassis Cisco EtherChannel link interfaces or other distributed Cisco EtherChannel interfaces because they are source-only or destination-only by nature.

Access Control Lists

This section examines the way access lists are modified in the Cisco Virtual Switching System environment.

Essentially three types of ACLs are supported in a Cisco Catalyst 6500 system as of Cisco IOS Software Release 12.2(33)SXH (Figure 31):

- Router ACLs (RACLs)
- VLAN ACLs (VACLs)
- Port-based ACLs (PACLs)

Figure 31. Access-List Processing

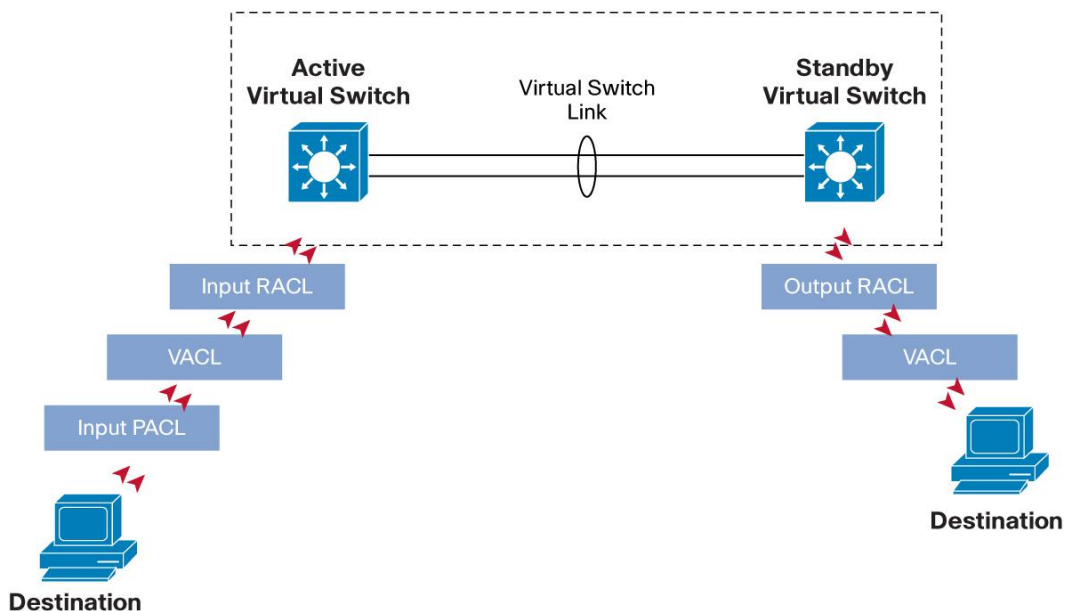

All of these ACLs are compiled by the system and programmed into hardware-based ternary content addressable memory (TCAM) on the system PFCs or DFCs. Within a Cisco Virtual Switching System environment, these ACLs are compiled by the active route processor for the entire system (on the active virtual switch) and programmed to all PFCs and DFCs in the system.

Router ACLs

Router ACLs refers to all ACLs that are applied to interfaces that also have an IP address specified, including Layer 3 physical routed interfaces, Layer 3 SVIs, as well as port-channel interfaces. Directional by nature, RACLs apply only to traffic that is routed through those specific interfaces.

In a Cisco Virtual Switching System environment, RACLs do not change significantly, since they can be applied to all Layer 3 interfaces across the entire system (on Switch 1, Switch 2, or both). Global TCAM show commands, however, have been extended to account for the switch keyword. For example:

```
vss#sh tcam counts switch 1
Used Free Percent Used Reserved
---- ---- -
Labels:(in) 4 4092 0
Labels:(eg) 2 4094 0
ACL_TCAM
-----
Masks: 77 4019 1 72
Entries: 49 32719 0 576
QOS_TCAM
-----
Masks: 22 4074 0 18
Entries: 22 32746 0 144
LOU: 0 128 0
ANDOR: 0 16 0
ORAND: 0 16 0
ADJ: 3 2045 0

vss#sh tcam counts switch 2
Used Free Percent Used Reserved
---- ---- -
Labels:(in) 4 4092 0
Labels:(eg) 2 4094 0
ACL_TCAM
-----
Masks: 77 4019 1 72
Entries: 49 32719 0 576
QOS_TCAM
-----
Masks: 22 4074 0 18
Entries: 22 32746 0 144 LOU: 0 128 0
ANDOR: 0 16 0
ORAND: 0 16 0
ADJ: 3 2045 0
```

VLAN ACLs

VACLs refers to all ACLs that are applied to Layer 2 VLANs directly and affect both traffic that is switched within the VLAN for which the VACL is applied. Traffic that is routed through the VLAN. VACLs are bidirectional.

In a Cisco Virtual Switching System environment, VACLs do not change significantly, because they can be applied across VLANs that are local to a particular virtual switch as well as across the entire Cisco Virtual Switching System. Global TCAM show commands have also been extended to account for the switch keyword.

Port-Based ACLs

PACLs refers to those ACLs that are applied directly to a physical port that is also configured as a Layer 2 switchport. Note that when an IP address is applied to such an interface, the ACL becomes a RACL. PACLs are directional by nature, and only ingress PACLs are supported.

For software releases prior to 12.2(33)SX14 there are some changes made to the way PACLs are applied in a Cisco Virtual Switching System environment. They relate to the current software restriction that does not allow the system to consecutively address more than 2000 ports from a Layer 2 ACL indexing perspective. This limitation implies that PACLs cannot be applied to physical orphan ports - ports that exist on a single chassis only. You can apply PACLs only on Layer 2 Cisco EtherChannel links or multichassis Cisco EtherChannel links. This behavior is evidenced by the CLI not being available on physical Layer 2 interfaces:

```
vss(config)#int gig 1/5/2
vss(config-if)#switchport
vss(config-if)#ip ?
Interface IP configuration subcommands:
admission Apply Network Admission Control
arp Configure ARP features
auth-proxy Apply authentication proxy
<...snip...>
vss(config)#int port-channel 102
vss(config-if)#switchport
vss(config-if)#ip ?
Interface IP configuration subcommands:
access-group Specify access control for packets
admission Apply Network Admission Control
arp Configure ARP features
auth-proxy Apply authenticaton proxy
<...snip...>
```

PACLs on physical Layer 2 interfaces are supported in VSS beginning in the 12.2(33)SX14 software.



Americas Headquarters
Cisco Systems, Inc.
San Jose, CA

Asia Pacific Headquarters
Cisco Systems (USA) Pte. Ltd.
Singapore

Europe Headquarters
Cisco Systems International BV Amsterdam,
The Netherlands

Cisco has more than 200 offices worldwide. Addresses, phone numbers, and fax numbers are listed on the Cisco Website at www.cisco.com/go/offices.

Cisco and the Cisco logo are trademarks or registered trademarks of Cisco and/or its affiliates in the U.S. and other countries. To view a list of Cisco trademarks, go to this URL: www.cisco.com/go/trademarks. Third party trademarks mentioned are the property of their respective owners. The use of the word partner does not imply a partnership relationship between Cisco and any other company. (1110R)