

**Z207 BLUETOOTH®
COMPUTER SPEAKERS
HAUT-PARLEURS Z207 BLUETOOTH®
POUR ORDINATEUR**

Complete Setup Guide
Guide d'installation complet

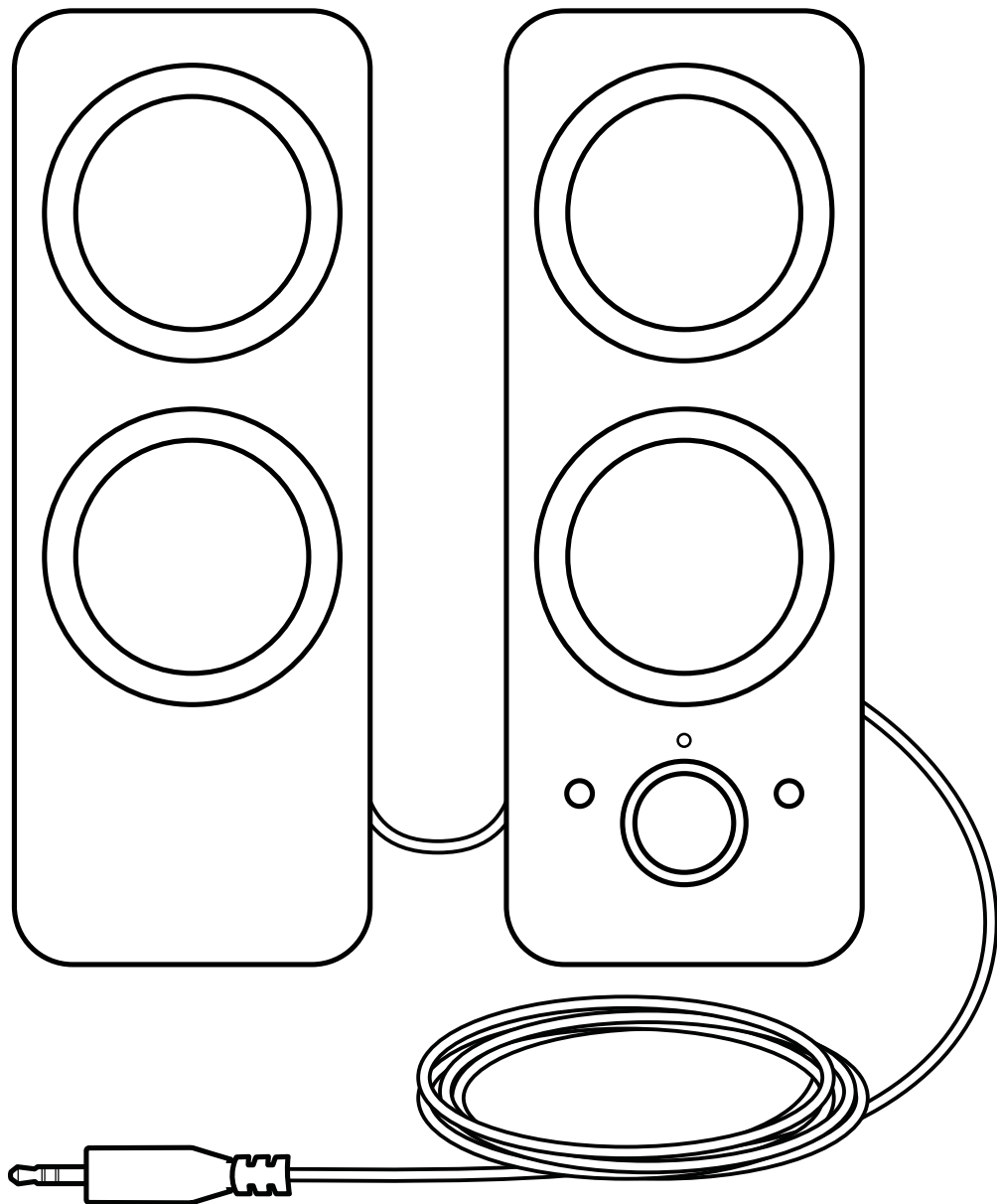

logitech®

CONTENTS

English3

Français6

Español9

Português 12

KNOW YOUR PRODUCT

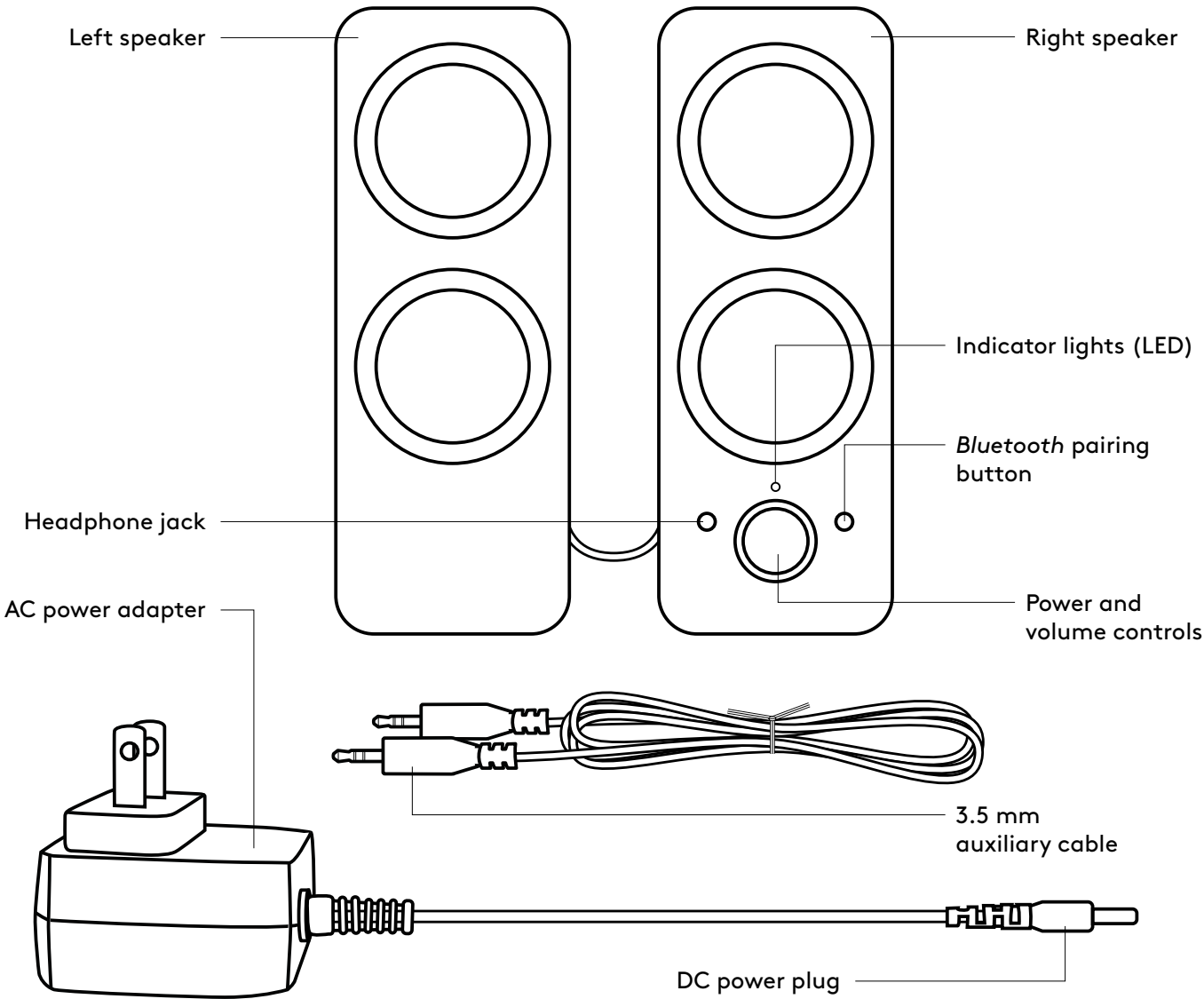

CONNECT THE SPEAKERS

1. Connect the DC power plug to the back of your right speaker and connect your AC adapter to the electrical outlet.
2. Connect to the 3.5 mm audio jack on your source device using the 3.5mm auxiliary input on the back of the right speaker.
3. (Optional) Connect your headphones to the headphone jack at the front of the right speaker.
4. Turn the speaker on using the power knob.
5. To pair your devices with speakers using *Bluetooth*, press the *Bluetooth* pairing button for 3 seconds until the LED starts blinking. Turn on *Bluetooth* on your device and select "Logi Z207" to connect to it. The LED will then turn to a steady blue light after pairing.

1

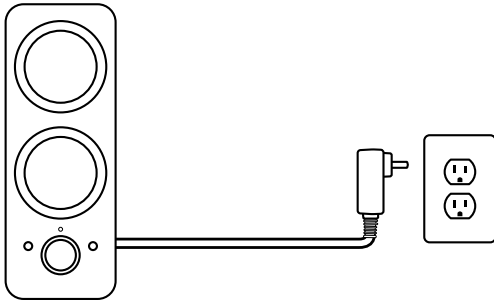

2

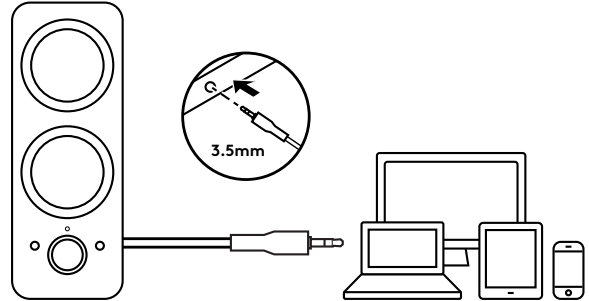

3

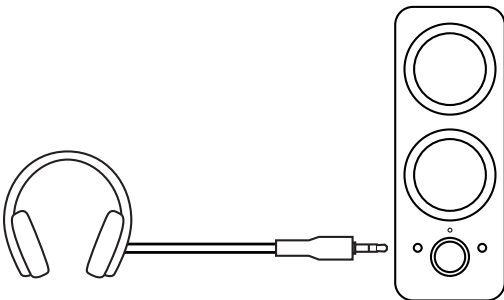

4

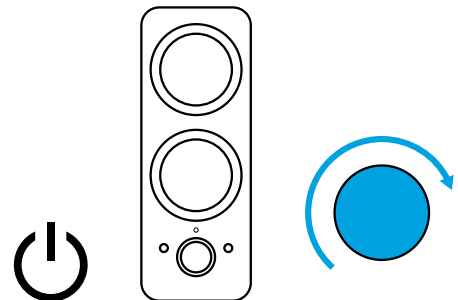

5

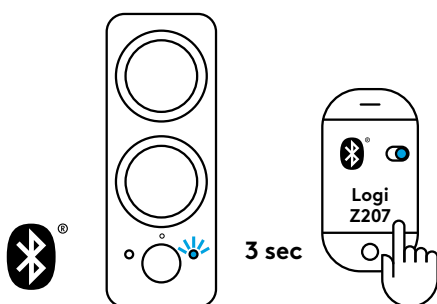

ADJUST THE VOLUME

1. Increase (or decrease) the volume of speakers by rotating the volume control knob clockwise (or counter-clockwise) on the right speaker.

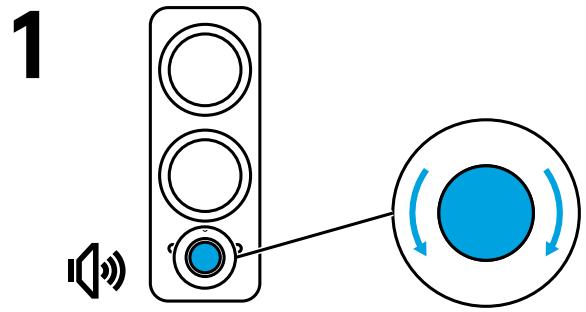

www.logitech.com/support/Z207

© 2019 Logitech. Logitech, Logi and other Logitech marks are owned by Logitech and may be registered. All other trademarks are the property of their respective owners. Logitech assumes no responsibility for any errors that may appear in this manual. Information contained herein is subject to change without notice.

PRÉSENTATION DU PRODUIT

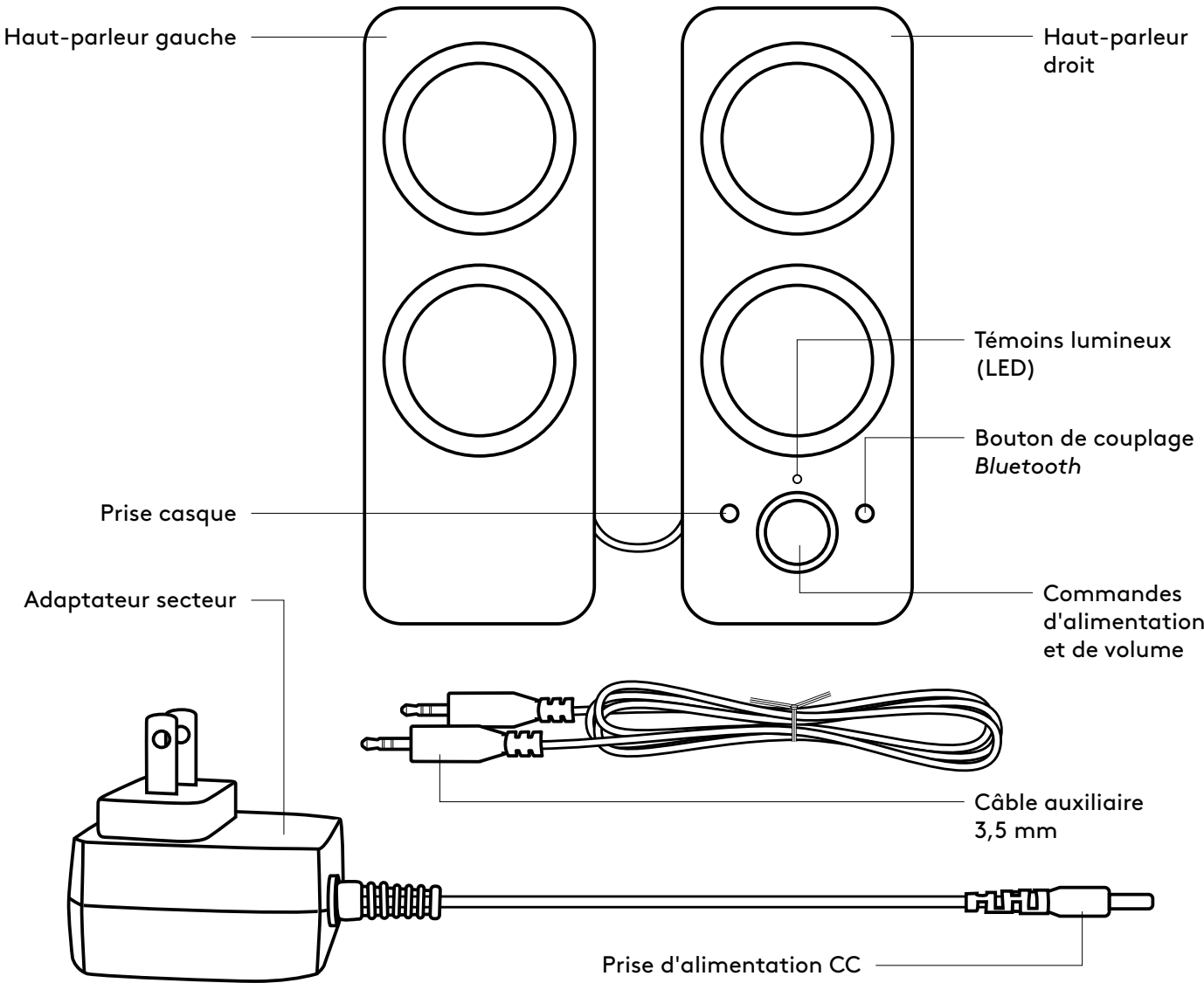

CONNEXION DES HAUT-PARLEURS

1. Connectez la prise d'alimentation CC à l'arrière de votre haut-parleur droit, puis connectez l'adaptateur secteur à une prise électrique.
2. Connectez la prise audio 3,5 mm sur votre dispositif source à l'aide de l'entrée auxiliaire 3,5 mm située à l'arrière du haut-parleur droit.
3. (Facultatif) Connectez votre casque à la prise casque située à l'avant du haut-parleur droit.
4. Allumez votre haut-parleur en utilisant le bouton Marche/Arrêt.
5. Pour coupler vos dispositifs avec vos haut-parleurs via *Bluetooth*, appuyez sur le bouton de couplage *Bluetooth* pendant 3 secondes jusqu'à ce que le témoin lumineux commence à clignoter. Activez le *Bluetooth* sur votre dispositif, puis sélectionnez "Logi Z207" pour vous y connecter. Le témoin lumineux passera alors au bleu continu après le couplage.

1

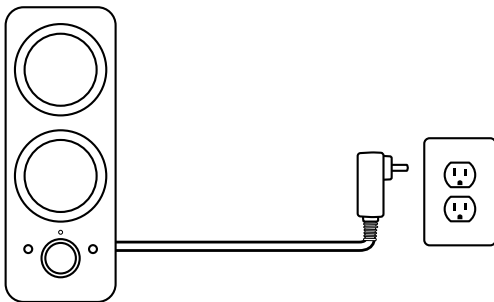

2

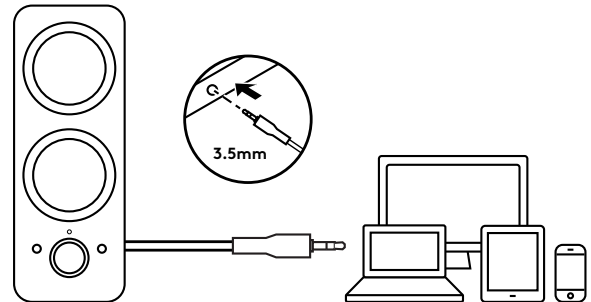

3

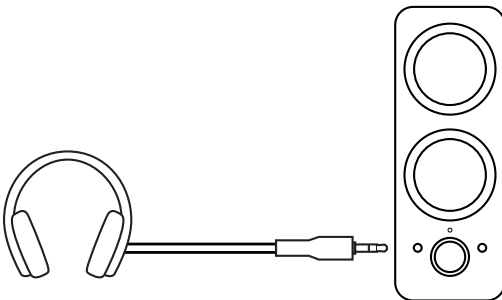

4

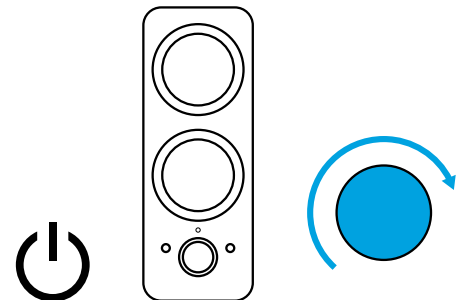

5

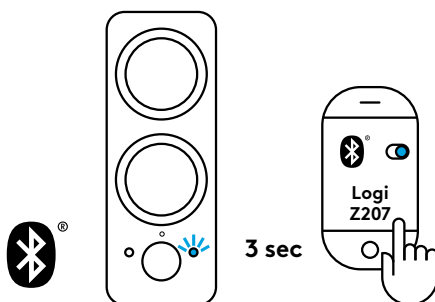

AJUSTEMENT DU VOLUME

1. Augmentez (ou baissez) le volume des haut-parleurs en faisant tourner la molette de contrôle du volume dans le sens horaire (ou antihoraire) sur le haut-parleur droit.

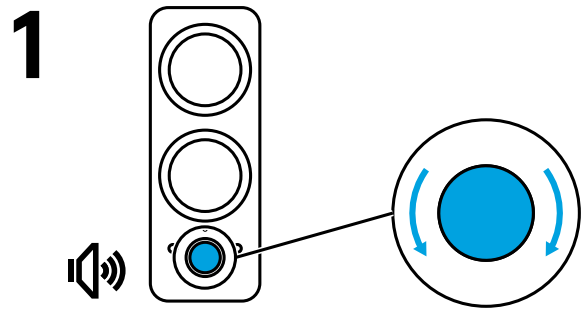

www.logitech.com/support/Z207

© 2019 Logitech. Logitech, Logi et les autres marques Logitech sont la propriété de Logitech et sont susceptibles d'être déposées. Toutes les autres marques sont la propriété exclusive de leurs détenteurs respectifs. Logitech décline toute responsabilité en cas d'erreurs susceptibles de s'être glissées dans le présent manuel. Les informations énoncées dans ce document peuvent faire l'objet de modifications sans préavis.

COMPONENTES DEL PRODUCTO

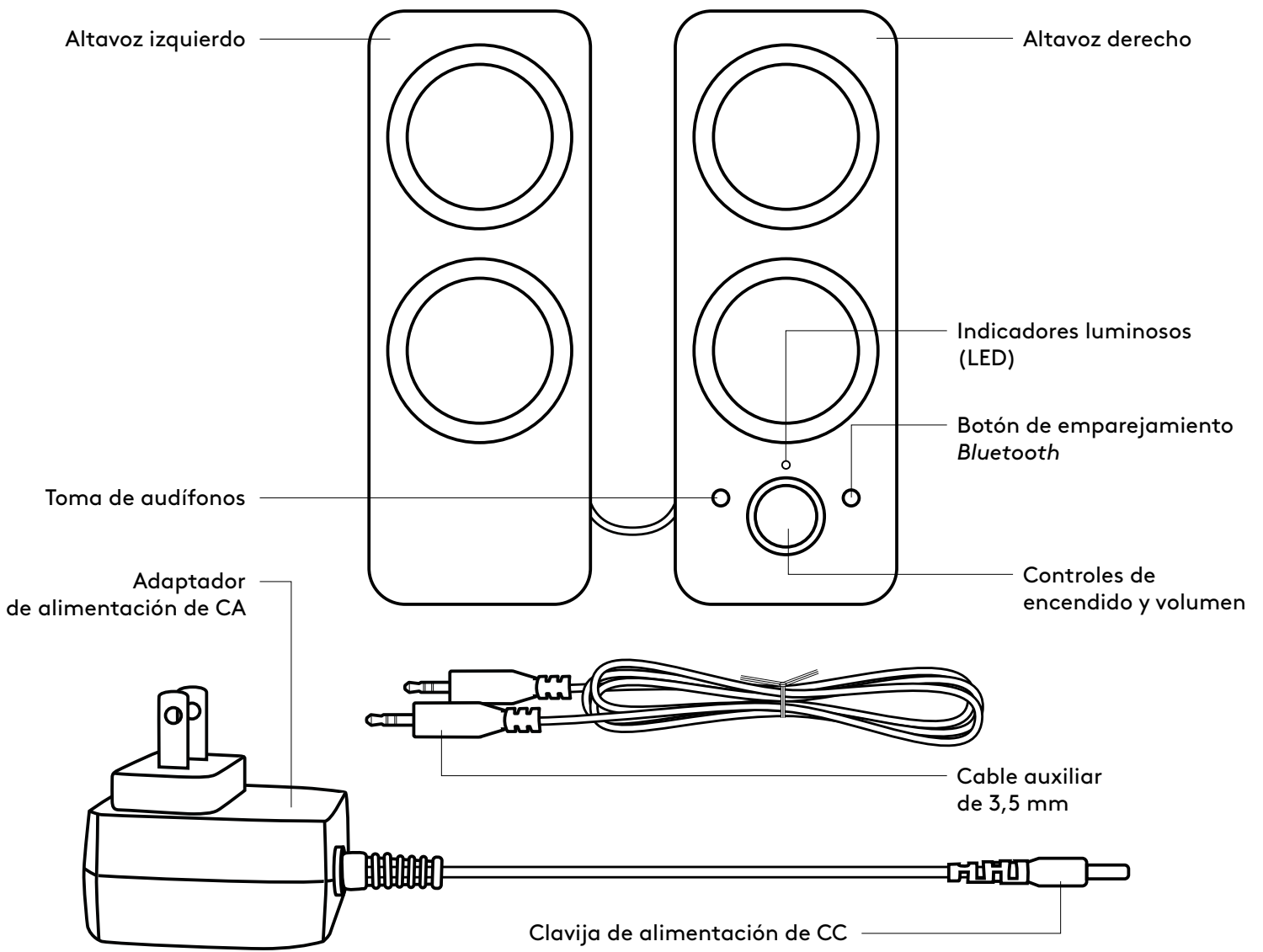

CONECTA LOS ALTAVOCES

1. Conecta la clavija de alimentación de CC a la parte posterior del altavoz derecho y conecta el adaptador de CA a la toma de corriente.
2. Conecta a la toma de audio de 3,5 mm de tu dispositivo de origen usando la entrada auxiliar de 3,5 mm situada en la parte posterior del altavoz derecho.
3. (Opcional) Conecta los audífonos a la toma de audífonos situada en la parte frontal del altavoz derecho.
4. Enciende el altavoz mediante el control giratorio de encendido.
5. Para emparejar dispositivos con los altavoces mediante *Bluetooth*, presiona el botón de emparejamiento *Bluetooth* durante tres segundos hasta que el LED empiece a emitir destellos. Activa *Bluetooth* en tu dispositivo y selecciona "Logi Z207" para establecer la conexión. El LED permanecerá iluminado con luz azul después del emparejamiento.

1

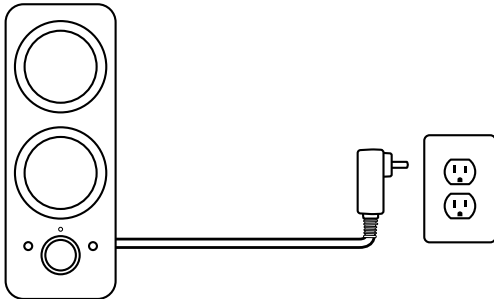

2

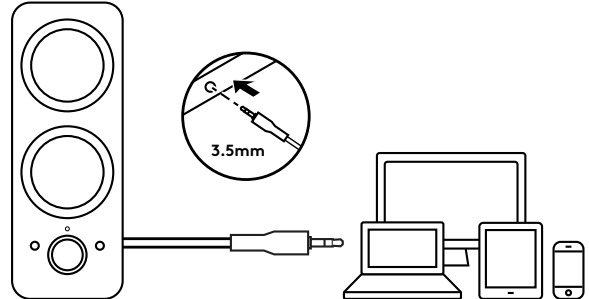

3

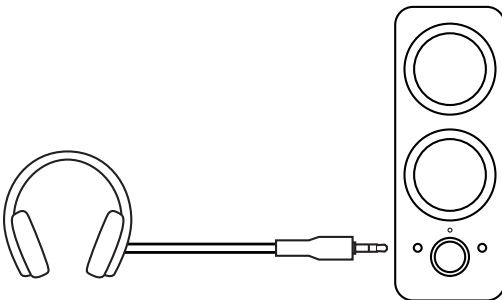

4

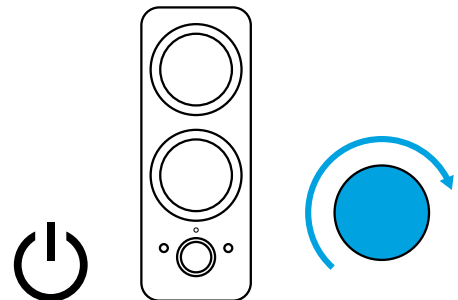

5

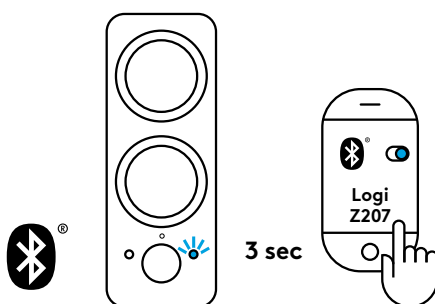

AJUSTA EL VOLUMEN

1. Aumenta (o disminuye) el volumen de los altavoces girando el control giratorio de volumen en el sentido de las agujas del reloj (o en sentido contrario) en el altavoz derecho.

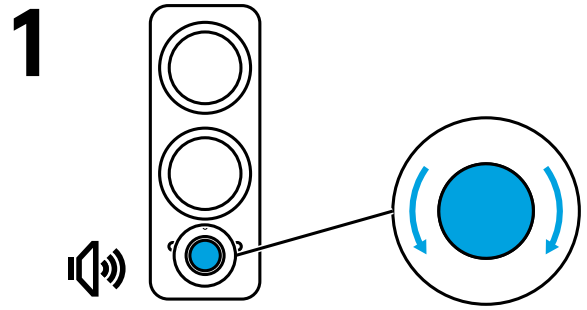

www.logitech.com/support/Z207

© 2019 Logitech. Logitech, Logi y otras marcas de Logitech pertenecen a Logitech y pueden estar registradas. Las demás marcas comerciales pertenecen a sus respectivos propietarios. Logitech no asume ninguna responsabilidad por la presencia de posibles errores en el presente manual. La información aquí contenida está sujeta a posibles cambios sin previo aviso.

CONHEÇA O SEU PRODUTO

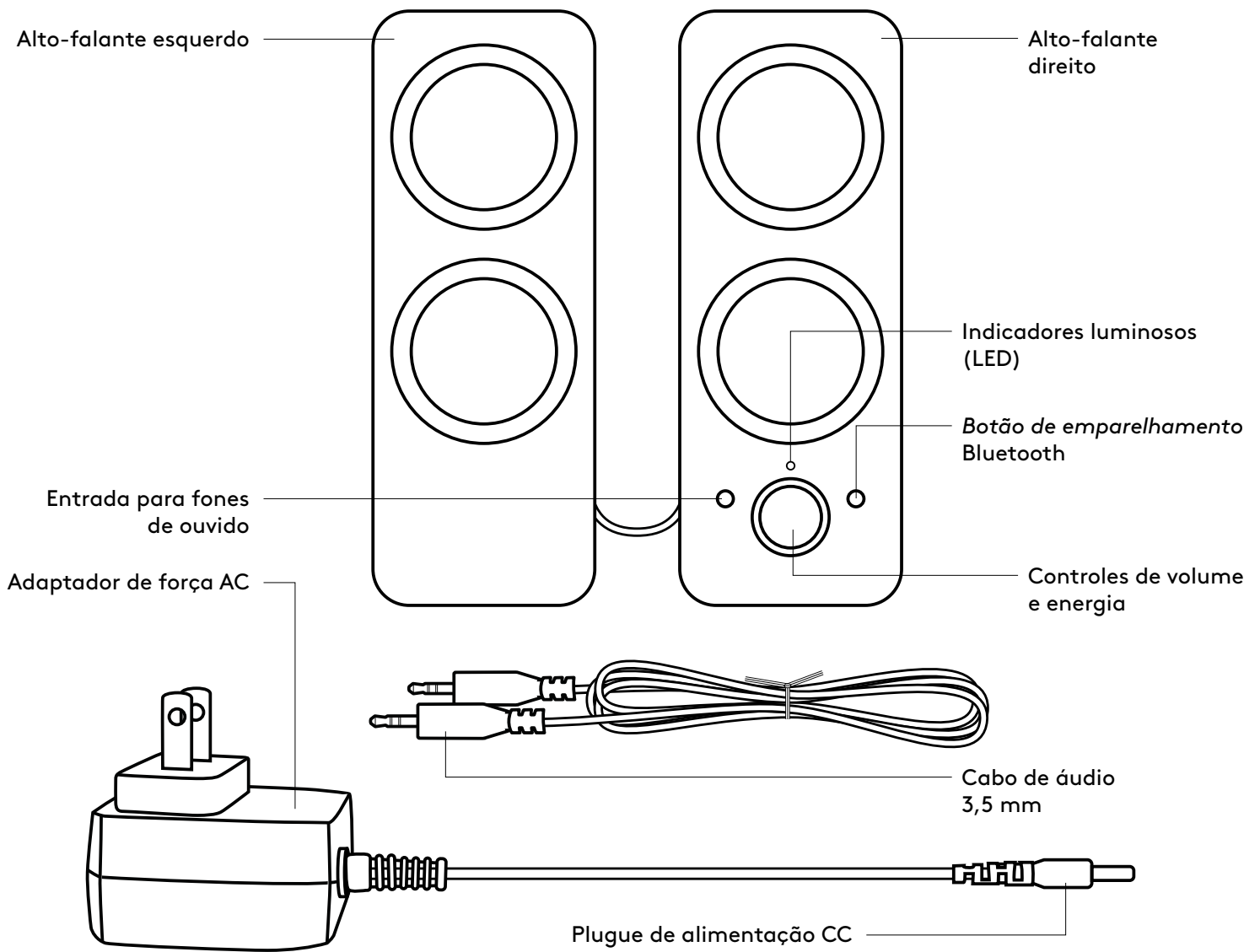

CONECTE OS ALTO-FALANTES

1. Conecte o plugue de energia CC na parte traseira do alto-falante direito e conecte o adaptador CA à tomada elétrica.
2. Conecte à entrada de áudio de 3,5 mm do dispositivo de origem usando a entrada auxiliar de 3,5 mm na parte traseira do alto-falante direito.
3. (Opcional) Conecte seu fone de ouvido ao conector de fone de ouvido na frente do alto-falante direito.
4. Ligue o alto-falante usando o botão de energia.
5. Para emparelhar seus dispositivos com alto-falantes usando *Bluetooth*, pressione o botão de emparelhamento *Bluetooth* por 3 segundos até que o LED comece a piscar. Ligue o *Bluetooth* no seu dispositivo e selecione "Logi Z207" para se conectar. O LED acenderá com uma luz azul constante após o emparelhamento.

1

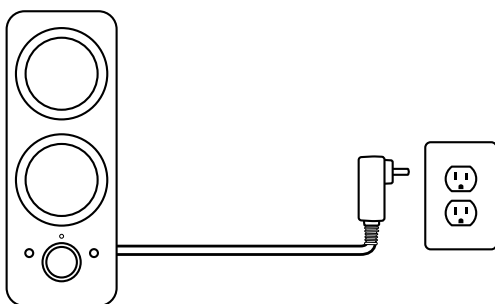

2

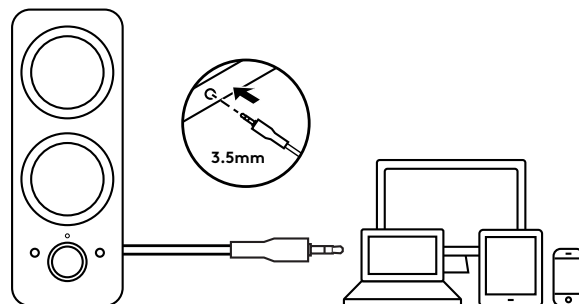

3

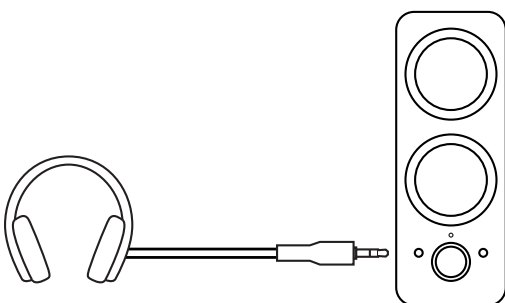

4

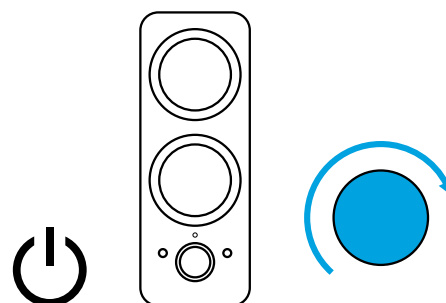

5

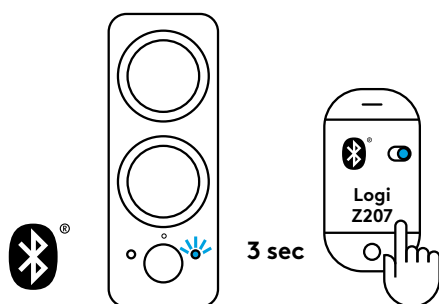

AJUSTE O VOLUME

1. Aumente (ou diminua) o volume dos alto-falantes girando o botão de controle de volume no sentido horário (ou anti-horário) no alto-falante direito.

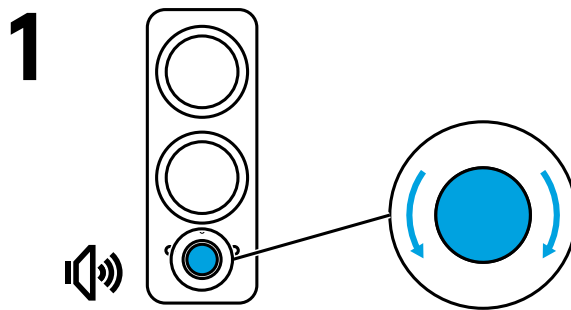

www.logitech.com/support/Z207

© 2019 Logitech. Logitech, Logi e outras marcas da Logitech são propriedades da Logitech e podem estar registradas. Todas as outras marcas comerciais são propriedades dos respectivos titulares. A Logitech não se responsabiliza por quaisquer erros possíveis neste manual. As informações aqui contidas estão sujeitas a alterações sem prévio aviso.

www.logitech.com/support/Z207

© 2019 Logitech. Logitech, Logi and other Logitech marks are owned by Logitech and may be registered. All other trademarks are the property of their respective owners. Logitech assumes no responsibility for any errors that may appear in this manual. Information contained herein is subject to change without notice.

© 2019 Logitech. Logitech, Logi et les autres marques Logitech sont la propriété de Logitech et sont susceptibles d'être déposées. Toutes les autres marques sont la propriété exclusive de leurs détenteurs respectifs. Logitech décline toute responsabilité en cas d'erreurs susceptibles de s'être glissées dans le présent manuel. Les informations énoncées dans ce document peuvent faire l'objet de modifications sans préavis.

WEB-621-001016.003

logitech®