

Aspire T180/E380
AcerPower M8
Service Guide

Service guide files and updates are available on the AIPG/CSD web; for more information, please refer to <http://csd.acer.com.tw>

PRINTED IN TAIWAN

Revision History

Please refer to the table below for the updates made on Aspire T180/E380 and AcerPower M8 service guide.

Date	Chapter	Updates

Copyright

Copyright © 2006 by Acer Incorporated. All rights reserved. No part of this publication may be reproduced, transmitted, transcribed, stored in a retrieval system, or translated into any language or computer language, in any form or by any means, electronic, mechanical, magnetic, optical, chemical, manual or otherwise, without the prior written permission of Acer Incorporated.

Disclaimer

The information in this guide is subject to change without notice.

Acer Incorporated makes no representations or warranties, either expressed or implied, with respect to the contents hereof and specifically disclaims any warranties of merchantability or fitness for any particular purpose. Any Acer Incorporated software described in this manual is sold or licensed "as is". Should the programs prove defective following their purchase, the buyer (and not Acer Incorporated, its distributor, or its dealer) assumes the entire cost of all necessary servicing, repair, and any incidental or consequential damages resulting from any defect in the software.

Acer is a registered trademark of Acer Corporation.

Intel is a registered trademark of Intel Corporation.

Pentium 4 and Celeron are trademarks of Intel Corporation.

Other brand and product names are trademarks and/or registered trademarks of their respective holders.

Conventions

The following conventions are used in this manual:

SCREEN MESSAGES	Denotes actual messages that appear on screen.
NOTE	Gives bits and pieces of additional information related to the current topic.
WARNING	Alerts you to any damage that might result from doing or not doing specific actions.
CAUTION	Gives precautionary measures to avoid possible hardware or software problems.
IMPORTANT	Reminds you to do specific actions relevant to the accomplishment of procedures.

Preface

Before using this information and the product it supports, please read the following general information.

1. This Service Guide provides you with all technical information relating to the BASIC CONFIGURATION decided for Acer's "global" product offering. To better fit local market requirements and enhance product competitiveness, your regional office MAY have decided to extend the functionality of a machine (e.g. add-on card, modem, or extra memory capability). These LOCALIZED FEATURES will NOT be covered in this generic service guide. In such cases, please contact your regional offices or the responsible personnel/channel to provide you with further technical details.
2. Please note WHEN ORDERING FRU PARTS, that you should check the most up-to-date information available on your regional web or channel. If, for whatever reason, a part number change is made, it will not be noted in the printed Service Guide. For ACER-AUTHORIZED SERVICE PROVIDERS, your Acer office may have a DIFFERENT part number code to those given in the FRU list of this printed Service Guide. You MUST use the list provided by your regional Acer office to order FRU parts for repair and service of customer machines.

Chapter1 System Specifications 1

Features.....	2
Mainboard Placement	5
Block Diagram	7
Aspire T180 Front Panel	8
Aspire T180 Rear Panel	9
AcerPower M8 Front Panel	10
AcerPower M8 Rear Panel	12
System Peripherals	13
Acer eRecovery	15
Acer disc-to-disc recovery	17
Hardware Specifications and Configurations	18
Power Management Function (ACPI support function)	23

Chapter2 System Utilities 24

Entering Setup	25
Product Information	27
Standard CMOS Features	28
Advanced BIOS Features	30
Advanced Chipset Features	34
Integrated Peripherals	35
Onboard I/O Chip Setup	38
Power Management Setup	39
PnP/PCI Feature	41
PC Health Status	42
Set Supervisor/User Password	43
Load Default Settings	44
Save & Exit Setup	45
Exit Without Saving	46

Chapter3 Machine Disassembly and Replacement 47

General Information	48
Disassembly Procedure	49

Chapter4 Troubleshooting 69

Chapter5 Jumper and Connector Information 70

Jumper Setting	70
----------------------	----

Chapter6 FRU (Field Replaceable Unit) List 83

Exploded Diagram	84
FRU List	87

System Specifications

Overview

The model is a consumer/commercial-oriented desktop PC built with latest, high-performance technology for easier and funnier consumer environment. It is a high performance and multi-media features ready system including Media Card Reader and Rear I/O connectors for 7.1 audio channels.

Regarding the high performance, we choose AMD Athlon 64 X2/Athlon64/Sempron (AM2 Socket), with NVIDIA MCP61 chipset architecture. This combination can run HyperTransport technology and provide On-Board VGA, which provides better performance than other processors. We also provide one PCI-Express x16 slot, one PCI-Express x1 and two PCI slots (support PCI 2.3 spec.), four Dual Channel DDRII memory slots (support up to 4GB), two PATA ports, two/four SATA ports (HDDs), on board Gigabit LAN, and on board Audio function.

Features

Processor

- Socket Type : 940 pin socket
- Processor Type : AMD AM2 Athlon64 x2/Athlon64/Sempron

Chipset

- nVidia MCP61S (co-lay with MCP61P)

PCB

- Form Factor : Mirco ATX
- Size (Max.) : 244mm x 244mm

Memory

- Memory Type : DDRII unbuffered SDRAM module support
- No of Channel (Dual/Signal) : Dual channel should be enabled always when plug-in 2 same memory size DDRII memory module
- Socket Type : un-buffered 240 pin DIMM socket
- DIMM Slot : 4
- Memory Size Max. : Up to 1 GB

Graphics

- Onboard graphic solution: nVidia MCP61 integrated graphics device solution
- One VGA port on rear

PCI

- One PCI Express x16 slot
- One PCI Express x1 slot
- Two PCI 2.2 Slots

FDD

- Slot Quantity : 1
- Support 1.44MB 3.5" Devices

IDE

- One 40 pin PATA IDE slot
- Transfer rate support:
 - PIO mode: 0/1/2/3/4
 - ATA mode: 33/66/100 port supported
- Storage type support : HDD/CD-ROM/CD-RW/DVD-ROM/DVD-RW/DVD+RW/DVD Dual/DVD SuperMultiPlus/HD DVD/BlueRay DVD
- 4 pin SATA IDE connector
- Transfer rate support:
 - 1.5GB/s and 3.0 GB/s
- Storage type support : HDD/CD-ROM/DVD-ROM/DVD-RW/DVD+RW/DVD Dual/DVD SuperMultiPlus

Audio

- Audio Type : HD Codec
- Audio Channel : 7.1 channel
- Audio Controller /Codec : Realtek ALC888(co-lay with ALC883)
- Support SPDIF out/in
- Audio Connectors/Headers:
 - Rear 6 jack follow HD audio definition
 - Microphone In
 - Headphone Out
 - CD-In

LAN

- Type : Marvell 88E8056 Gigabit Ethernet controller
- Supports 10/100/1000MB Ethernet environment

IEEE 1394

- IEEE 1394 Controller : TI TSB43AB23PDTG4
- IEEE 1394 Port : One rear 6pin IEEE 1394 port

USB

- Controller : nVidia MCP61
- USB Type : 2.0/1.1
- Connectors Quantity: 8
 - Real Panel : 4
 - Onboard header: 4 for front daughter board, 4 for rear I/O
- Standard Intel FPIO pin definition

BIOS

- BIOS Type : Award BIOS
- 4MB Flash BIOS
- Award PnP BIOS compatible with SM BIOS 2.3
- ACPI, SMBIOS 2.3, Green and Boot Block.
- Provides DMI 2.0, WFM 2.0, WOL, and SM Bus for system management.

I/O Connector

- Controller : Super I/O ITE 8726 co-lay with ITE8716

Rear I/O Connector

- 1 PS/2 Keyboard Port, 1 PS/2 Mouse Port
- 1 Parallel Port, 1 Serial Port
- 1 VGA(CRT) Port
- 1 LAN Port
- 4 USB Ports for non-1394 sku; 4 USB ports + IEEE1394 port for 1394 sku
- 7.1 channel phone jack

Onboard Connector

- 1 CPU socket
- 4 Memory slots
- 1 PCI Express x16 slot
- 1 PCI Express x1 slot
- 2 PCI slots
- 1 FDD connector
- 1 PATA IDE slot
- 2/4 SATA IDE connectors
- 2/3 2*5 pin Intel FPIO sepcification USB pin connectors.
- 1 2*5 pin IEEE 1394 jumper
- 1 CD-IN 4pin connector (CD-ROM/TV Tuner Card Audio Input)
- 1 S/PDIF out 3pin jumper
- 1 4pin CPU Fan connector
- 1 4pin system fan connector with 3pin system fan co-lay
- 1 24pin ATX interface PS3/PS2 SPS connector
- 1 2*7 pin front panel IO header
- 2 reserved 2pin GPIO jumper
- 1 onboard buzzer
- Color management for on board connector

Power Supply

- PSP Type : 250/300W

Mainboard Placement

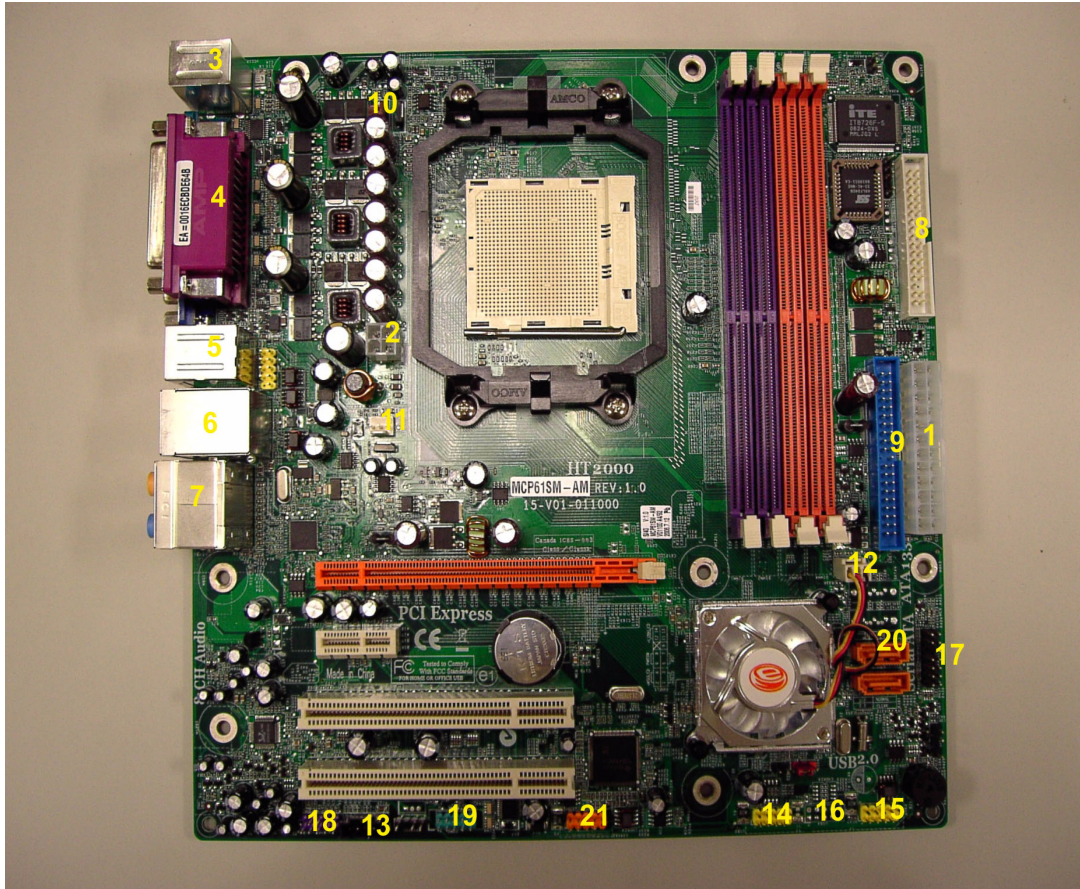

No.	Name	Description
1	ATX_POWER1	ATX_POWER
2	VCC12_VRM1	ATX_POWER-12V
3	PSKBM1	PS/2 Keyboard and Mouse Connector
4	LPT1	Parallel Port
5	USB1394A1	USB Dual Port +1394
6	USBLAN1	USB Dual Port +LAN Connector
7	JS1	Rear Audio Connector
8	FDD1	Floppy Connector
9	IDE1	HDD Primary Connector
10	CPU_FAN	CPU Fan
11	SYS_FAN	System Fan
12	PWR_FAN	Power Fan
13	AUX_IN1	CD-in low profile header
14	USB2	USB Header with INTEL spec.
15	USB3	USB Header with INTEL spec.
16	USB4	USB Header with INTEL spec.
17	PANEL1	Front Panel with INTEL spec.
18	AUDIO1	Audio Header with INTEL spec.

No.	Name	Description
19	COM2	Serial Port2
20	SATA1~4	Serial ATA Header

Block Diagram

BLOCK DIAGRAM

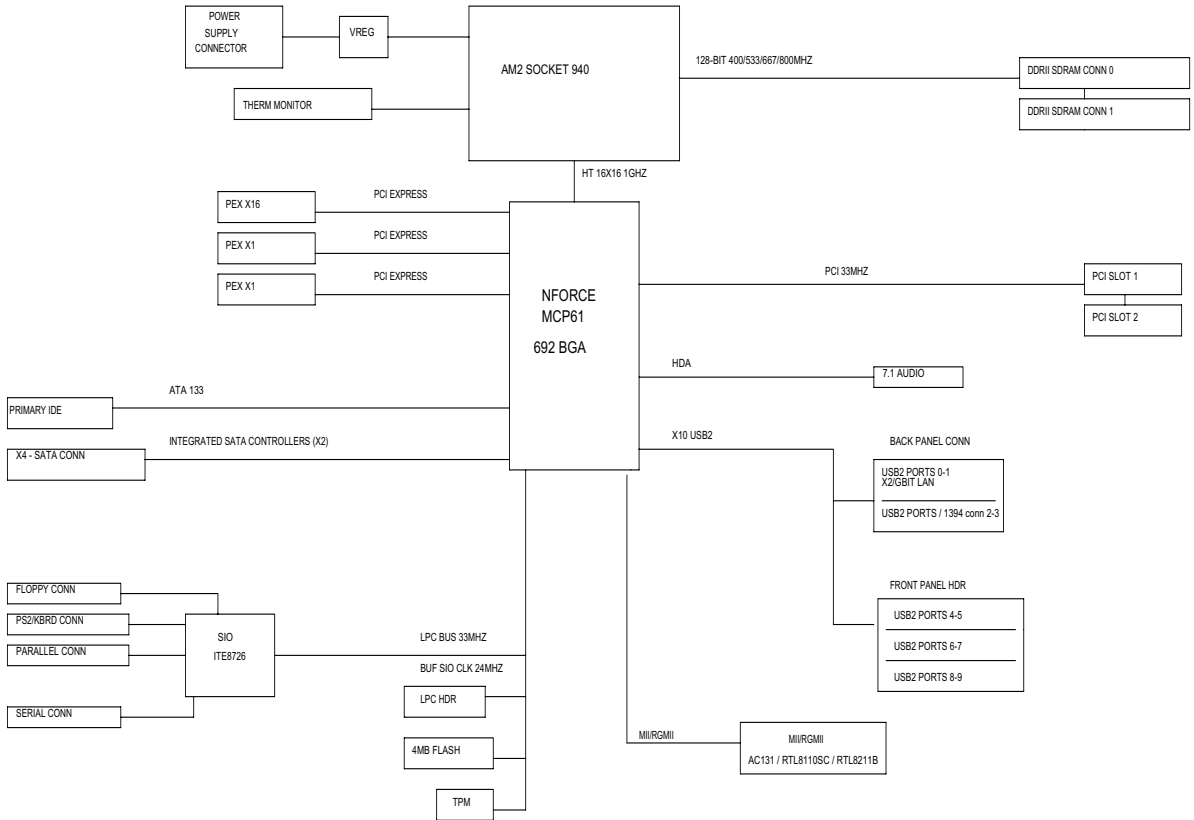

Aspire T180 Front Panel

The computer's front panel consists of the following:

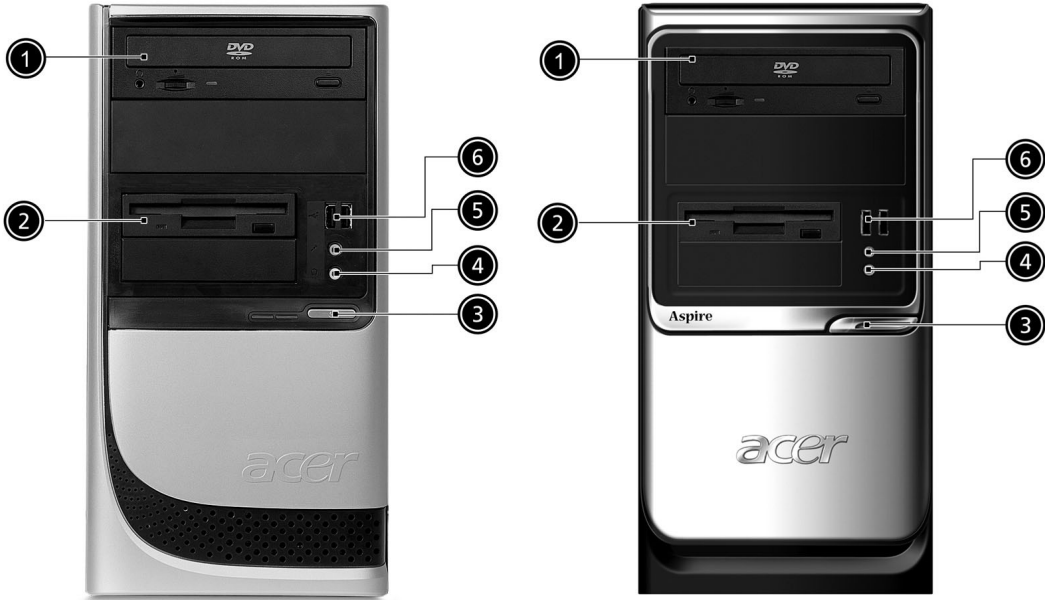

Label	Description
1	Optical drive
2	Floppy disk drive
3	Power button
4	Speaker or headphone jack
5	Microphone jack
6	USB ports

Aspire T180 Rear Panel

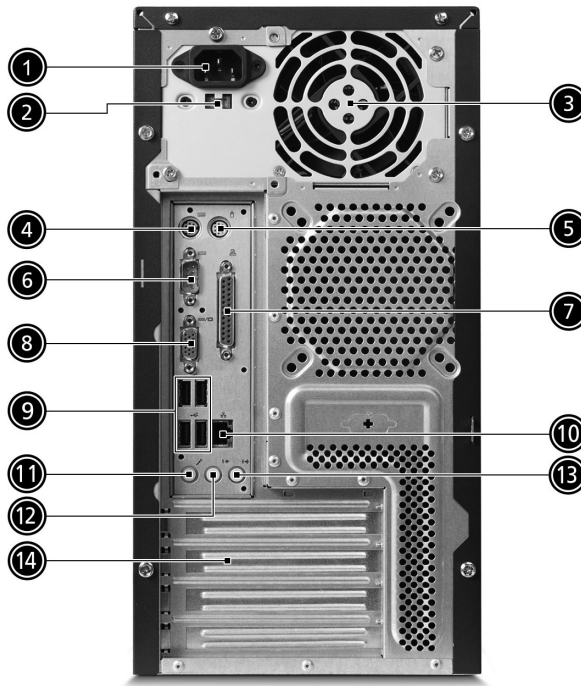

No.	Description	No.	Description
1	Power cord socket	2	Voltage selector switch
3	Fan aperture	4	PS/2 keyboard connector
5	PS/2 mouse connector	6	Serial port
7	Printer connector	8	Monitor connector
9	USB 2.0 ports	10	RJ-45 Ethernet connector
11	Microphone jack	12	Line-out Jack
13	Line-in jack	14	Extension card slots

AcerPower M8 Front Panel

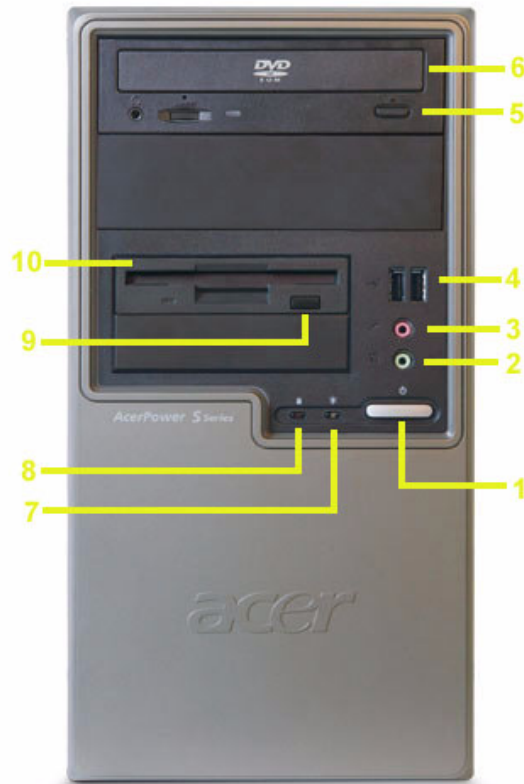

Label	Description
1	Power-Button
2	Speaker-out/Line-out Port
3	Microphone-in out (Front)
4	USB Ports
5	Optical drive eject button
6	Optical drive
7	Power LED
8	HDD LED
9	Floppy drive eject button
10	Floppy disk drive

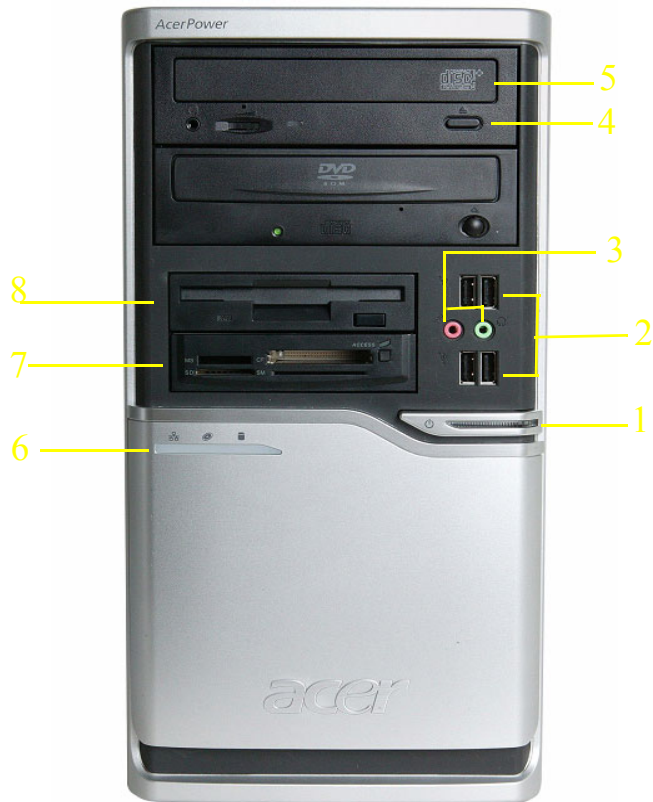

Label	Description
1	Power-Button
2	USB ports
3	Microphone-in & Speaker-out/Line-out Port
4	Optical drive eject button
5	Optical drive
6	Indicators
7	Card reader
8	HDD

AcerPower M8 Rear Panel

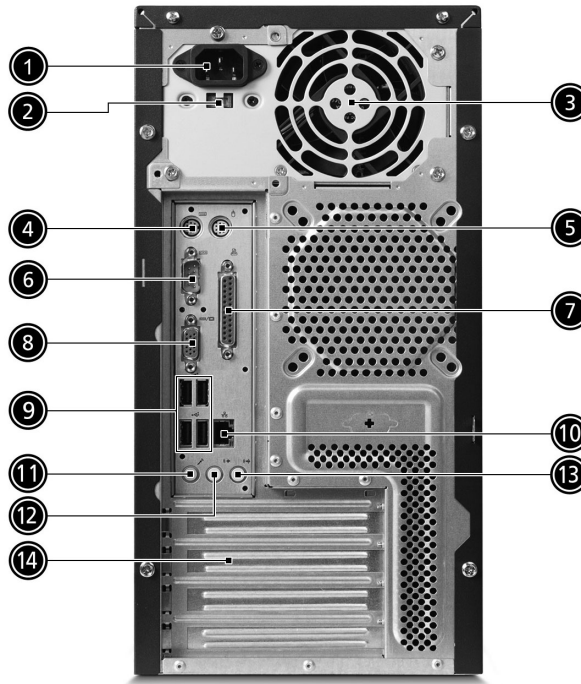

No.	Description	No.	Description
1	Power cord socket	2	Voltage selector switch
3	Fan aperture	4	PS/2 keyboard connector
5	PS/2 mouse connector	6	Serial port
7	Printer connector	8	Monitor connector
9	USB 2.0 ports	10	RJ-45 Ethernet connector
11	Microphone jack	12	Line-out Jack
13	Line-in jack	14	Extension card slots

System Peripherals

The Aspire S Series computer consist of the system itself, and system peripherals, like a mouse, keyboard and a set of speakers (optional). This section provides a brief description of the basic system peripherals.

Mouse (PS/2 or USB, manufacturing option)

The included mouse is a standard two-button wheel mouse. Connect the mouse to the PS/2 mouse port or USB port on the back panel of the system.



Keyboard (PS/2 or USB, manufacturing option)

Connect the keyboard to the PS/2 keyboard port or USB port on the back panel of the system.



Speakers

For systems bundled with speakers, before powering on the system, connect the speaker cable to the audio out (external speaker) port on the back panel of the system.

For more detailed information about the speakers, please refer to the included operating instructions.

NOTE: speakers are optional and the appearance might be different depending on the actual product.



Acer eRecovery

Acer eRecovery is a tool to quickly backup and restore the system. Users can create and save a backup of the current system configuration to hard drive, CD, or DVD.

Acer eRecovery consists of the following functions:

1. Create backup
2. Restore from backup
3. Create factory default image CD
4. Re-install bundled software without CD
5. Change Acer eRecovery password

Create backup

Users can create and save backup images to hard drive, CD, or DVD.

1. Boot to Windows XP
2. Press **<Alt>+<F10>** to open the Acer eRecovery utility.
3. Enter the password to proceed. The default password is six zeros.
4. In the Acer eRecovery window, select **Recovery settings** and click **Next**
5. In the Recovery settings window, select **Backup snapshot image** and click **Next**.
6. Select the backup method.
 - Use **Backup to HDD** to store the backup disc image on drive D:.
 - Backup to optical device** to store the backup disc image on CD or DVD (only available on systems that include an optical disc burner).
7. After choosing the backup method, click **Next**.

Follow the instruction on screen to complete the process.

Restore from backup

Users can restore backup previously created (as stated in the **Create backup** section) from hard drive, CD, or DVD.

1. Boot to Windows XP.
2. Press **<Alt>+<F10>** to open the Acer eRecovery utility.
3. Enter the password to proceed. The default password is six zeros.
4. In the Acer eRecovery window, select **Recovery actions** and click **Next**.
5. Select the desired restore action and follow the onscreen instructions to complete the restore process.

Create factory default image CD

When the System CD and Recovery CD are not available, you can create them by using this feature.

1. Boot to Windows XP.
2. Press **<Alt>+<F10>** to open the Acer eRecovery utility.
3. Enter the password to proceed. The default password is six zeros.
4. In the Acer eRecovery window, select **Recovery settings** and click **Next**.
5. In the Recovery settings window, select **Burn image to disc** and click **Next**.
6. In the Burn image to disc window, select **01. Factory default image** and click **Next**.

-
7. Follow the instructions on screen to complete the process.

Re-install bundled software without CD

Acer eRecovery stores pre-loaded software internally for easy driver and application re-installation.

1. Boot to Windows XP.
2. Press **<Alt>+<F10>** to open the Acer eRecovery utility.
3. Enter the password to proceed. The default password is six zeros.
4. In the Acer eRecovery window, select Recovery actions and click **Next**.
5. In the Recovery settings window, select **Reinstall applications/drivers** and click **Next**.
6. Select the desired driver/application and follow the instructions on screen to re-install.

At first launch, Acer eRecovery prepares all the needed software and may take few seconds to bring up the software content window.

Change Password

Acer eRecovery and Acer disc-to-disc recovery are protected by a password that can be changed by the user. Follow the steps below to change the password in Acer eRecovery.

1. Boot to Windows XP.
2. Press **<Alt>+<F10>** to open the Acer eRecovery utility.
3. Enter the password to proceed. The default password is six zeros.
4. In the Acer eRecovery window, select **Recovery settings** and click **Next**.
5. In the Recovery settings window, select **Password: Change Acer eRecovery password** and click **Next**.
6. Follow the instructions on screen to complete the process.

Acer disc-to-disc recovery

Restore without a Recovery CD

This recovery process helps you restore the C: drive with the original software content that is installed when you purchase your notebook. Follow the steps below to rebuild your C: drive. (Your C: drive will be reformatted and all data will be erased.) It is important to back up all data files before you use this option.

1. Restart the system.
2. While the Acer logo is showing, press <Alt>+<F10> at the same time to enter the recovery process.
3. The message "The system has password protection. Please enter 000000:" is displayed.
4. Enter six zeros and continue.
5. The Acer Recovery main page appears.
6. Use the arrow keys to scroll through the items (operating system versions) and press <Enter> to select.

Multilingual operating system installation

Follow the instructions to choose the operating system and language you prefer when you first power-on the system.

1. Turn on the system.
2. Acer's multilingual operating system selection menu will pop-up automatically.
3. Use the arrow keys to scroll to the language version you want. Press <Enter> to confirm your selection.
4. The operating system and language you choose now will be the only option for future recovery operations.
5. The system will install the operating system and language you choose.

Hardware Specifications and Configurations

Processor

Item	Specification
Type	AMD AM2 processor
Socket	AMD AM2 socket 940
Speed	System bus total up to 20.8GB/s
FSB	2000MT/s

BIOS

Item	Specification
BIOS code programmer	Award
BIOS version	v6.0
BIOS ROM type	Flash ROM
BIOS ROM size	4MB
BIOS ROM package	32-pin DIP package
Support protocol	ACPI 2.0, APM 1.2, SMBIOS 2.3, WFM support, ASD 1.03, PXE boot ROM, PCI 2.3
Boot from CD-ROM feature	Yes
Support to LS-120 FDD drive	Yes
Support to BIOS boot block feature	Yes

NOTE: The BIOS can be overwritten/upgraded by using the flash utility.

BIOS Hotkey List

Hotkey	Function	Description
Delete	Enter BIOS Setup Utility	Press while the system is booting to enter BIOS Setup Utility.

Main Board Major Chips

Item	Controller
NorthBridge	nVidia MCP61S/MCP61P single chip solution
SouthBridge	
AGP controller	Embedded nVidia MCP61S graphic core
Super I/O controller	ITE8726
Audio controller	ALC888
LAN controller	Marvell 88E8056 Gigabit Ethernet controller
HDD controller	nVidia MCP61S/MCP61P
Keyboard controller	ITE8726

System Memory

Item	Specification
Memory slot number	4 slot
Support memory size per socket	256MB to 1GB
Support maximum memory size	1GB
Support memory type	DDR2 DRAM
Support memory interface	DDR2 667/533/400
Support memory voltage	1.8V
Support memory module package	240-pin DIMM
Support to parity check feature	Yes
Support to Error Correction Code (ECC) feature	ECC checking with double-bit detect and single-bit correct
Memory module combinations	You can install memory modules in any combination as long as they match the specifications.

NOTE: Dual channel should be enabled always when plug-in 2 same memory size DDRII memory module.

Cache Memory

Item	Specification
First-Level Cache Configurations	
Cache function control	Enable/Disable by BIOS Setup
Second-Level Cache Configurations	
L2 Cache RAM type	PBSRAM
L2 Cache RAM size	up to 1MB per core(exclusive)
L2 Cache RAM speed	One-half the processor core clock frequency
L2 Cache function control	Enable/Disable by BIOS Setup
L2 Cache scheme	Fixed in write-back

Video Memory

Item	Specification
Memory size	512MB > system memory >= 256MB on board VGA share 32 MB 1GB > system memory >= 512MB share memory size 128MB system memory > 512MB share memory size 256 MB

Video Interface

Item	Specification
Video controller	nVidia MCP61
Video controller resident bus	PCIE
Video Interface	x16
AGP Slot	1

Audio Interface

Item	Specification
Audio controller	nVidia MCP61
Audio controller Type	AC'97, ALC888
Audio Channel	7.1ch
Audio function control	Enable/disable by BIOS Setup
Mono or stereo	Stereo
Resolution	support up to 24 bit
Compatibility	Sound Blaster Pro/16 compatible Mixed digital and analog high performance chip Enhanced stereo full duplex operation High performance audio accelerator and AC'97 support Full native DOS games compatibility Virtual FM enhances audio experience through real-time FM-to-Wavetable conversion MPU-401(UART mode) interface for wavetable synthesizers and MIDI devices Integrated dual game port Meets AC'97and WHQL specifications
Music synthesizer	Yes, internal FM synthesizer
Sampling rate	DACs: 44.1k/48k/96k/192k Hz ADCs: 44.1k/48k/96k Hz
MPU-401 UART support	Yes
Microphone jack	Supported
Headphone jack	Supported

IDE Interface

Item	Specification
IDE controller	nVidia MCP61
IDE controller resident bus	PCI bus
Number of IDE channel	1 x ATA133
Support IDE interface	E-IDE (up to PIO mode-4 and Ultra DMA 33/66/100/133), ANSIS ATA rev.3.0 ATAPI
Support bootable CD-ROM	Yes

Floppy disk drive Interface

Item	Specification
Floppy disk drive controller	ITE8726
Floppy disk drive controller resident bus	LPC bus
Support FDD format	should support 1.44MB/3mode 3.5" Devices

Parallel Port

Item	Specification
Parallel port controller	ITE8726
Parallel port controller resident bus	ISA bus
Number of parallel ports	1
Support ECP/EPP	Bi-directional SPP / ECP / EPP V1.7&V1.9
Connector type	25-pin D-type female connector
Parallel port function control	Enable/disable by BIOS Setup

Serial Port

Item	Specification
Serial port controller	ITE8726
Serial port controller resident bus	ISA bus
Number of serial port	2
16550 UART support	Yes
Connector type	9-pin D-type female connector
Features	Support IrDA1.0/ASKIR protocols, smart card reader protocols

USB Port

Item	Specification
Universal HCI	USB 2.0
USB Class	Support legacy keyboard for legacy mode
USB Number	support up to 8 ports

Environmental Requirements

Item	Specifications
Temperature	
Operating	+5°C ~ +35°C
Non-operating	-20 ~ +60°C (Storage package)
Humidity	
Operating	15% to 80% RH
Non-operating	10% to 90% RH
Vibration	
Operating (unpacked)	5 ~ 500 Hz:2.20g RMS random, 10 minutes per axis in all 3 axes 5 ~500 Hz: 1.09g RMS random, 1 hour per axis in all 3 axes

Power Management

Devices	S1 (Idle)	S3 (Suspend to RAM)	S4 (Suspend to Disk)	S5 (Shut Down)
Power Button	Enabled	Enabled	Enabled	Disabled

Power Management

Devices	S1 (Idle)	S3 (Suspend to RAM)	S4 (Suspend to Disk)	S5 (Shut Down)
USB Keyboard	Enabled	Enabled	Disabled	N/A
LAN	Disabled	Disabled	Disabled	Disabled
RTC	Disabled	Enabled	Disabled	Disabled
Modem (Ring)	Disabled	Disabled	Disabled	N/A

Power Management Function (ACPI support function)

Device Standby Mode

- Independent power management timer for hard disk drive devices (0-15 minutes, time step=1 minute).
- Hard disk drive goes into Standby mode (for ATA standard interface).
- Disable V-sync to control the VESA DPMS monitor.
- Resume method: device activated (Keyboard for DOS, keyboard & mouse for Windows).
- Resume recovery time: 3-5 sec.

Global Standby Mode

- Global power management timer (2-120 minutes, time step=10 minute).
- Hard disk drive goes into Standby mode (for ATA standard interface).
- Disable H-sync and V-sync signals to control the VESA DPMS monitor.
- Resume method: Return to original state by pushing external switch button, modem ring in, keyboard and mouse for APM mode.
- Resume recovery time: 7-10 sec.

Suspend Mode

- Independent power management timer (2-120 minutes, time step=10 minutes) or pushing external switch button.
- CPU goes into SMM.
- CPU asserts STPCLK# and goes into the Stop Grant State.
- LED on the panel turns amber colour.
- Hard disk drive goes into SLEEP mode (for ATA standard interface).
- Disable H-sync and V-sync signals to control the VESA DPMS monitor.
- Ultra I/O and VGA chip go into power saving mode.
- Resume method: Return to original state by pushing external switch button, modem ring in, keyboard and mouse for APM mode.
- Return to original state by pushing external switch button, modem ring in and USB keyboard for ACPI mode.

ACPI

- ACPI specification 1.0b.
- S0, S1, S3 and S5 sleep state support.
- On board device power management support.
- On board device configuration support.

System Utilities

Most systems are already configured by the manufacturer or the dealer. There is no need to run Setup when starting the computer unless you get a Run Setup message.

The Setup program loads configuration values into the battery-backed nonvolatile memory called CMOS RAM. This memory area is not part of the system RAM.

NOTE: If you repeatedly receive Run Setup messages, the battery may be bad/flat. In this case, the system cannot retain configuration values in CMOS.

Before you run Setup, make sure that you have saved all open files. The system reboots immediately after you exit Setup.

Entering Setup





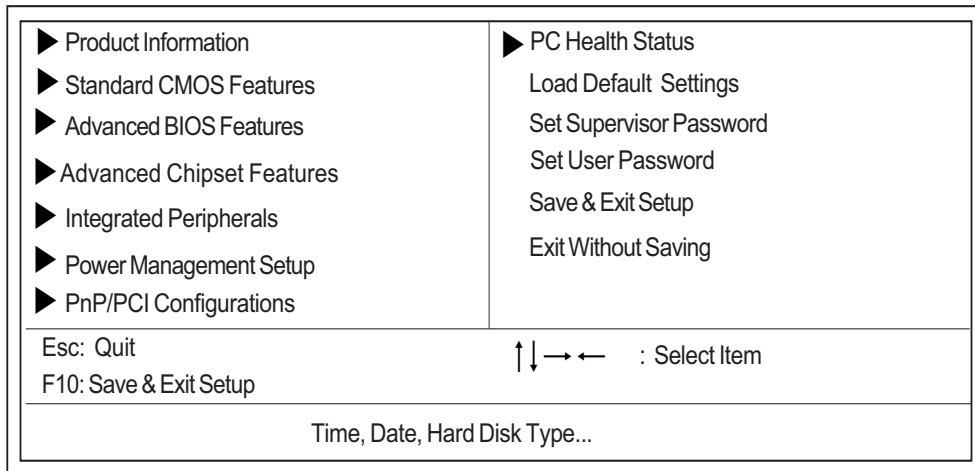

Power on the computer and the system will start POST (Power On Self Test) process. When the message of "Press DEL to enter SETUP" appears on the screen, press the key of [Delete] to enter the setup menu.

NOTE: If the message disappears before you respond and you still wish to enter Setup, restart the system by turning it OFF and On. You may also restart the system by simultaneously pressing [Ctrl+Alt+Delete].

The Setup Utility main menu then appears:



The command line at the bottom of the menu tells you how to move within a screen and from one screen to another.

- To select an option, move the highlight bar by pressing  or  then press .
- To change a parameter setting, press  or  until the desired setting is found.
- Press  to return to the main menu. If you are already in the main menu, press  again to exit Setup.

The parameters on the screens show default values. These values may not be the same as those in your system.

The grayed items on the screens have fixed settings and are not user-configured.

NOTE: Due to the application of a new version of BIOS Setup program, you may find the BIOS menu is largely different from the former models. However, you will soon find out that this version is much more compact than the former ones.

The items in the main menu are explained below:

- ❑ **Product Information**
To introduce the Product Name, System P/N and MainBoard ID...etc.
- ❑ **Standard CMOS Features**
The basic system configuration can be set up through this menu.
- ❑ **Advanced BIOS Features**
The advanced system features can be set up through this menu.
- ❑ **Advanced Chipset Features**
The values for the chipset can be changed through this menu, and the system performance can be optimized.
- ❑ **Integrated Peripherals**
All onboard peripherals can be set up through this menu.
- ❑ **Power Management Setup**
All the items of Green function features can be set up through this menu.
- ❑ **PnP/PCI Configurations**
The system's PnP/PCI settings and parameters can be modified through this menu.
- ❑ **PC Health Status**
This will display the current status of your PC.
- ❑ **Set Supervisor/User Password**
The supervisor/user password can be set up through this menu.
- ❑ **Load Default Settings**
These parameter settings can be loaded through this menu, however, the stable default values may be affected.
- ❑ **Save & Exit Setup**
Save CMOS value settings to CMOS and exit setup.
- ❑ **Exit Without Saving**
Abandon all CMOS value changes and exit setup.

Product Information

The screen below appears if you select Product Information from the main menu:

The Product Information menu contains general data about the system, such as the product name, serial number, BIOS version, etc. These information is necessary for troubleshooting (maybe required when asking for technical support).

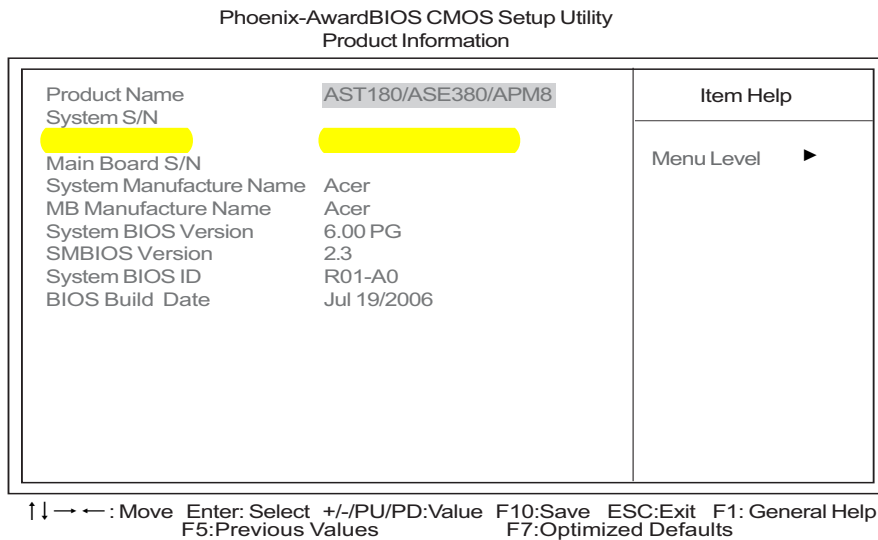

The following table describes the parameters found in this menu:

Parameter	Description
Product Names	Displays the model name of your system.
System S/N	Displays your system's serial number.
Main Board ID	Displays the main board's identification number.
Main Board S/N	Displays your main board's serial number.
System BIOS Version	Specifies the version of your BIOS utility.
SMBIOS version	The System Management Interface (SM) BIOS allows you to check your system hardware components without actually opening your system. Hardware checking is done via software during start up. This parameter specifies the version of the SMBIOS utility installed in your system.
BIOS Release Date	Displays the BIOS latest release date

Standard CMOS Features

Select Standard CMOS Features from the main menu to configure some basic parameters in your system. The following screen shows the Standard CMOS Features menu:

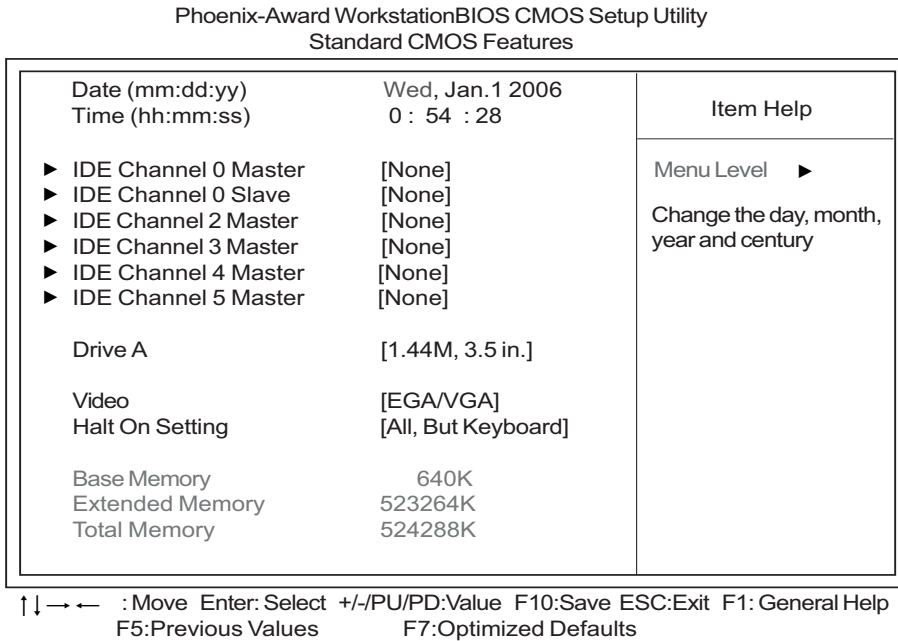

The following table describes the parameters found in this menu. Settings in **boldface** are the default and suggested settings.

Parameter	Description	Options
Date	Lets you set the date following the weekday-month-day-year format	Weekday: Sun, Mon...Sat Month: Jan., Feb...Dec. Day: 1 to 31 Year: 1999 to 2098
Time	Lets you set the time following the hour-minute-second format	Hour: 0 to 23 Minute: 0 to 59 Second: 0 to 59
IDE Channel 0/2/3/4/5 Master & IDE Channel 0 Slave	Leave this item at Auto to enable the system to automatically detect and configure IDE devices on the channel. If it fails to find a device, change the value to Manual and then manually configure the drive by entering the characteristics of the drive in the items described below.	IDE Device Model Number: Not Detected
Drive A	Allows you to configure your floppy drive A.	None 360 KB, 5.25-inch 1.2 MB, 5.25-inch 720 KB, 3.5-inch 1.44M, 3.5 - inch 2.88 MB, 3.5-inch
Video	This item defines the video mode of the system. The motherboard has a built-in VGA graphics system; you must leave this item at the default value.	EGA/VGA

Parameter	Description	Options
Halt On	This item defines the operation of the system POST(Power On Self Test) routine. You can use this item to select which types of errors in the POST are sufficient to halt the system.	All, But Keyboard
Base Memory, Extended Memory, and Total Memory	Total based and extended memory, and I/O ROM 384KB available to the system.	total memory of the system.

IDE Devices

Phoenix-Award WorkstationBIOS CMOS Setup Utility IDE Channel 0 Master

IDE HDD Auto-Detection	[Press Enter]	Item Help
IDE Channel 0 Master Access Mode	[Auto] [Auto]	Menu Level ▶▶
Capacity	80 GB	To auto-detect the HDD's size, head... on this channel
Cylinder	38309	
Head	16	
Precomp	0	
Landing Zone	38308	
Sector	255	

↑↓ → ← : Move Enter: Select +/-/PU/PD:Value F10:Save ESC:Exit F1: General Help
F5:Previous Values F7:Optimized Defaults

Parameter	Description	Options
IDE HDD Auto-Detection	Press <Enter> while this item is highlighted to prompt the Setup Utility to automatically detect and configure an IDE device on the IDE channel.	
Access Mode(Auto)	This item defines ways that can be used to access IDE hard disks such as LBA(Large Block Addressing). Leave this value at Auto and the system will automatically decide the fastest way to access the hard disk drive.	

Advanced BIOS Features

The following screen shows the Advanced BIOS Features:

Phoenix-Award Workstation BIOS CMOS Setup Utility
Advanced BIOS Features

<ul style="list-style-type: none"> ▶ Removable Device Priority ▶ Hard Disk Boot Priority ▶ CD-ROM Boot Priority Virus Warning Quick Power On Self Test First Boot Device Second Boot Device Third Boot Device Boot Other Device Boot Up Floppy Seek Boot Up NumLock Status Gate A20 Option Typematic Rate Setting X Typematic Rate (Chars/Sec) X Typematic Delay (Msec) Security Option X APIC Mode MPS Version Control for OS OS Select For DRAM > 64MB HDD S.M.A.R.T. Capability Silent Boot Small Logo (EPA) Show Configuration Table BIOS Bootblock Protect 	<p>[Press Enter] ▲</p> <p>[Press Enter]</p> <p>[Press Enter]</p> <p>[Disabled]</p> <p>[Enabled]</p> <p>[Removable]</p> <p>[Removable]</p> <p>[Removable]</p> <p>[Enabled]</p> <p>[Disabled]</p> <p>[On]</p> <p>[Fast]</p> <p>[Disabled]</p> <p>6</p> <p>250</p> <p>[Setup]</p> <p>[Enabled]</p> <p>[1.4]</p> <p>[Non-OS2]</p> <p>[Disabled]</p> <p>[Enabled]</p> <p>[Disabled]</p> <p>[Disabled]</p> <p>[Enabled]</p> <p>▼</p>	<p>Item Help</p> <hr/> <p>Menu Level ▶</p>
--	--	--

↑ ↓ ← → : Move Enter: Select +/-/PU/PD: Value F10: Save ESC: Exit F1: General Help
 F5: Previous Values F7: Optimized Defaults

The following table describes the parameters found in this menu. Settings in **boldface** are the default and suggested settings.

Parameter	Description	Options
Virus Warning	This item is used to enable or disable the virus warning.	Enabled Disabled
Quick Power On Self Test	Enable this item to shorten the power on testing (POST) and have your system start up faster. You might like to enable this item after you are confident that your system hardware is operating smoothly.	Enabled Disabled
First /Second/Third Boot Device	The items allow you to set the sequence of boot device where BIOS attempts to load the disk operating system.	Floppy, LS120, Hard Disk, CD-ROM, ZIP100, USB-FDD, USB-ZIP, LAN, Disabled (Disable this sequence). The sequence following the order of Floppy, HDD and CD-ROM is recommended.
CD/DVD Drives	Specifies the boot sequence from the available devices	Press [Enter]
Boot Other Device	This parameter allows you to specify the system boot up search sequence.	Enabled Disabled

Parameter	Description	Options
Boot Up Floppy Seek	If this item is enabled, it checks the size of the floppy disk drives at start-up time. You don't need to enable this item unless you have a legacy diskette drive with 360K capacity.	Enabled Disabled
Boot Up NumLock Status	Sets the NumLock status when the system is powered on. Setting to On will turn on the NumLock key when the system is powered on. Setting to Off will allows users to use the arrow keys on the numeric keypad.	On Off
Gate A20 Option	This item defines how the system handle legacy software that was written for an earlier generation of processors. Leave this item at the default value.	Fast
Typematic Rate Setting	If this item is enabled, you can use the following two items to set the typematic rate and typematic delay settings for your keyboard. --Typematic Rate(Chars/Sec): Use this item to define how many characters per second are generated by a held-down key. --Typematic Delay(Msec): Use this item to define how many milliseconds must elapse before a held-down key begins generating repeat characters.	Enabled Disabled
Security Option	This item determines when the users enter the assword, in the setup page or before system boot-up.	Setup
APIC Mode	This item allows you to enable or disable the APIC mode. APIC provides symmetric multi-processing for system, allowing support for up to 60 processors.	Enabled Disabled
MPS Version Control For OS	This item displays MPS version control for OS	1.4
OS Select For DRAM > 64 MB	This item is only required if you have installed more than 64 MB of memory and you are running the OS/2 operating system. Otherwise, leave this item at the default.	Non-OS2
HDD S.M.A.R.T Capability	The S.M.A.R.T(Self-monitoring, analysis, and reporting technology) system is a diagnostics technology that monitors and predicts device performance. S.M.A.R.T software resides on both the disk drive and the host computer.	Enabled Disabled
Silent Boot	This item enables or disables silent boot.	Enabled Disabled
Small Logo (EPA) Show	Enables or disables the display of the EPA logo during boot.	Enabled Disabled
Configuration Table	Enables or disables the display of configuration table	Enabled Disabled
BIOS Bootblock Protect	This item enables or disables BIOS bootblock protect.	Enabled Disabled

Removable Device Priority

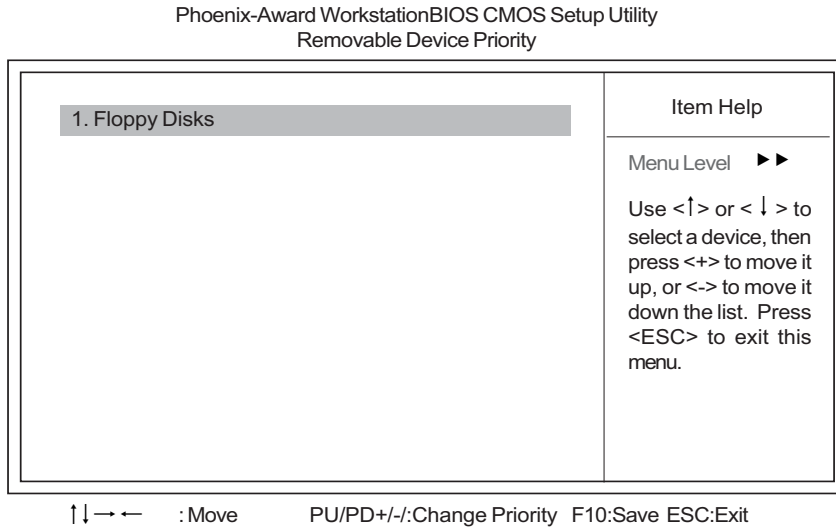

Hard Disk Boot Priority

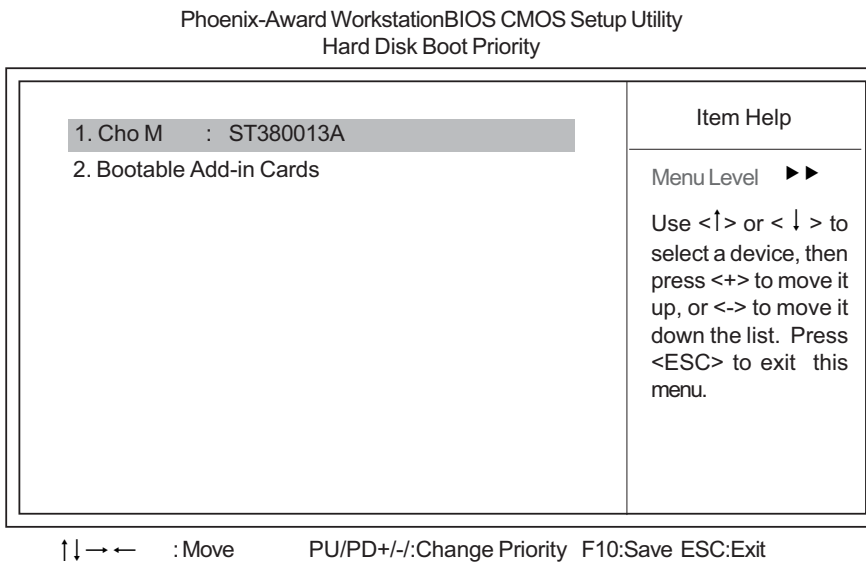

CD-ROM Boot Priority

Phoenix-Award Workstation BIOS CMOS Setup Utility
CD-ROM Boot Priority

1. Ch0 S. : LITE-ON DVD SOHD-16P9S	<p>Item Help</p> <p>Menu Level ▶▶</p> <p>Use <↑> or <↓> to select a device, then press <+> to move it up, or <-> to move it down the list. Press <ESC> to exit this menu.</p>
------------------------------------	---

↑↓→← : Move PU/PD+/-/: Change Priority F10: Save ESC: Exit

Advanced Chipset Features

These items define critical timing parameters of the motherboard. You should leave the items on this page at their default values unless you are very familiar with the technical specifications of your system hardware. If you change the values incorrectly, you may introduce fatal errors or recurring instability into your system.

Phoenix-Award Workstation BIOS CMOS Setup Utility Advanced Chipset Features

Dual Monitor Support [Enabled] Frame Buffer Size [Auto] HT Spread Spectrum [Center] SSE/SSE2 Instructions [Enabled] System BIOS Cacheable [Enabled]	Item Help <hr/> Menu Level ►
--	------------------------------------

↑↓ → ← : Move Enter: Select +/-/PU/PD: Value F10: Save ESC: Exit F1: General Help
 F5: Previous Values F7: Optimized Defaults

Parameter	Description	Options
Dual Monitor Support	This item enables or disables dual monitor support	Enabled Disabled
Frame Buffer Size	This item enables users to specify the Onboard VGA share memory size.	Auto Enabled Disabled
HT Spread Spectrum	This item, when enabled, can significantly reduce the EMI	Center
SSE/SSE2 Instructions	This item allows you to enable or disable the SSE/SSE2(Streaming SIMD Extensions) instruction set.	Enabled Disabled
System BIOS Cacheable	This item enables users to enable or disable the system BIOS cache.	Enabled Disabled

Integrated Peripherals

Phoenix-Award Workstation BIOS CMOS Setup Utility
Integrated Peripherals

<ul style="list-style-type: none"> ▶ IDE Function Setup [Press Enter] ▶ Onboard Device Setup [Press Enter] ▶ Super IO Device [Press Enter] 	<p>Item Help</p> <hr/> <p>Menu Level ▶</p>
---	--

↑↓→← : Move Enter: Select +/-/PU/PD:Value F10:Save ESC:Exit F1: General Help
F5:Previous Values F7:Optimized Defaults

IDE Function Setup

Phoenix-Award Workstation BIOS CMOS Setup Utility
IDE Function Setup

<ul style="list-style-type: none"> OnChip IDE Channel 0 [Enabled] Primary Master PIO [Auto] Primary Slave PIO [Auto] Primary Master UDMA [Auto] Primary Slave UDMA [Auto] IDE DMA transfer access [Enabled] Serial-ATA Controller [All Enabled] IDE Prefetch Mode [Enabled] IDE HDD Block Mode [Enabled] ▶ RAID Configuration [Press Enter] 	<p>Item Help</p> <hr/> <p>Menu Level ▶▶</p>
---	---

↑↓→← : Move Enter: Select +/-/PU/PD:Value F10:Save ESC:Exit F1: General Help
F5:Previous Values F7:Optimized Defaults

Parameter	Description	Options
On-Chip IDE Channel 0	Use these items to enable or disable the PCI IDE channels that are integrated on the motherboard.	Enabled Disabled

Parameter	Description	Options
Primary Master/Slave PIO	Each IDE channel supports a master device and a slave device. These four items let you assign the kind of PIO(Programmed Input/Output) was used by the IDE devices. Choose Auto to let the system auto detect which PIO mode is best, or select a PIO mode from 0-4	Auto
Secondary Master/Slave UDMA	Each IDE channel supports a master device and slave device. This motherboard supports UltraDMA technology, which provides faster access to IDE devices. If you install a device that supports UltraDMA, change the appropriate item on this list to Auto. You may have to install the UltraDMA driver supplied with this motherboard in order to use an UltraDMA device.	Auto
IDE DMA transfer access	This item allows users to enable the transfer access of the IDE DMA then burst onto the PCI bus and nonburstable transactions do not.	Enabled Disabled
Serial-ATA Controller	This item allows you to enable or disable the onboard SATA controller.	All enabled
IDE Prefetch Mode	The onboard IDE drive interface supports IDE prefetching for faster drive access. If you install a primary and secondary add-in IDE interface, set this field to Disabled if the interface does not support prefetching.	Enabled Disabled
IDE HDD Block Mode	Enables this field if your IDE hard drive supports block mode. Block mode enables BIOS to automatically detect the optimal number of block read and writes per sector that the drive can support and improves the speed of access to IDE devices.	Enabled Disabled

RAID Configuration

Phoenix-Award WorkstationBIOS CMOS Setup Utility RAID Configuration

RAID Enable	Disabled	Item Help
x SATA 1 Primary RAID	Disabled	Menu Level ▶▶
x SATA 1 Secondary RAID	Disabled	
x SATA 2 Primary RAID	Disabled	
x SATA2 Secondary RAID	Disabled	

↑↓→← :Move Enter:Select +/-/PU/PD:Value F10:Save ESC:Exit F1:General Help
F5:Previous Values F7:Optimized Defaults

Parameter	Description	Options
RAID Enable	This item allows you to enable or disable the onboard RAID function of RAID supporting devices	Enabled Disabled
SATA 1/2 Primary/ Secondary RAID	These four items display the status of SATA RAID.	Enabled Disabled

Onboard Device Setup

Phoenix-Award WorkstationBIOS CMOS Setup Utility
Onboard Device Setup

Onchip USB	[V1.1 + V2.0]	Item Help
USB Memory Type	[SHADOW]	
USB Keyboard Support	[Enabled]	Menu Level ▶▶
USB Mouse Support	[Enabled]	
HD Audio	[Auto]	
Onboard 1394	[Enabled]	
Giga Bit LAN	[Enabled]	
LAN Boot ROM	[Disabled]	

↑↓ → ← : Move Enter: Select +/-/PU/PD:Value F10:Save ESC:Exit F1: General Help
F5:Previous Values F7:Optimized Defaults

Parameter	Description	Options
Onchip USB	This item enables users to or disable the onchip USB function, setting it to be USB1.1	V1.1+V2.0
USB Memory Type	This item indicates the USB memory type.	SHADOW
USB Keyboard support	Enable this item if you plan to use a keyboard connected through the USB port in a legacy operating system(such as DOS) that does not support Plug and Play.	Enabled Disabled
USB Mouse Support	Enable this item if you plan to use a mouse connected through the USB port in a legacy operating syste(such as DOS) that does not support Plug and Play.	Enabled Disabled
HD Audio	Enables and disables the onboard audio chip. Disable this item if you are going to install a PCI audio add-in card.	Auto
Onboard 1394	This item enables or disables onboard 1394	Enabled Disabled
Giga Bit LAN	This item enables or disables Giga bit LAN	Enabled Disabled
LAN Boot ROM	This item enables or disables LAN Boot ROM.	Enabled Disabled

Onboard I/O Chip Setup

Phoenix-Award Workstation BIOS CMOS Setup Utility
Super I/O Device

Onboard FDC Controller	[Enabled]	Item Help
Onboard Serial Port 1	[3F8/IRQ4]	Menu Level ▶▶
Onboard Serial Port 2	[2F8/IRQ3]	
x UR2 Duplex Mode	Half	
Onboard Parallel Port	[378/IRQ7]	
Parallel Port Mode	[SPP]	
x ECP Mode Use DMA	[3]	

↑↓ → ← : Move Enter: Select +/-/PU/PD:Value F10:Save ESC:Exit F1: General Help
F5:Previous Values F7:Optimized Defaults

Parameter	Description	Options
Onboard FDC Controller	This option enables the onboard floppy disk drive controller.	Enabled Disabled
Onboard Serial Port 1/2	This option is used to assign the I/O address and interrupt request(IRQ) for onboard serial port 1.	3F8/IRQ4/2F8/IRQ3
UART Mode Select	This field is available if the onboard serial port 2 field is set to any option but Disabled. UART Mode Select enables you to select the infrared communication protocol-IrDA, ASKIR or SCR	Normal
UR2 Duplex Mode	This field is available when UART mode is set to either ASKIR or IrDA. This item enables you to determine the infrared function of the onboard infrared chip. The options are Full and Half. Full-duplex means that you can transmit and send information simultaneously. Half-duplex is the transmission of data in both directions, but only one direction at a time.	Half-Duplex Full-Duplex
Onboard Parallel Port	This option is used to assign the I/O address and interrupt request(IRQ) for the onboard parallel port.	378/IRQ7
Parallel Port Mode	Enables you to set the data transfer protocol for your parallel port. There are four options: SPP(Standard Parallel Port), EPP(Enhanced Parallel Port), ECP(Extended Capabilities Port) and ECP+EPP SPP allows data output only. Extended Capabilities Port(ECP) and Enhanced Parallel Port(EPP) are bi-directional modes, allowing both data input and output. ECP and EPP modes are only supported with EPP- and ECP-aware peripherals.	SPP
ECP Mode Use DMA	When the onboard parallel port is set to ECP mode, the parallel port can use DMA 3 or DMA 1	3

Power Management Setup

Phoenix-Award Workstation BIOS CMOS Setup Utility
Power Management Setup

ACPI Function	[Enabled]	Item Help
ACPI Suspend Type	[S1&S3]	
Power Management	[User Define]	Menu Level ►
Video Off Method	[DPMS Support]	
HDD Power Down	[Disabled]	
HDD Down In Suspend	[Disabled]	
Soft-Off by Power Button	[Delay 4 Sec]	
WOL(PME#)	[Disabled]	
WOR(RI#)	[Disabled]	
USB Resume from S1/S3	[Enabled]	
PS2 K/B Resume from S1/S3	[Enabled]	
Resume By Alarm	[Disabled]	
X Day of Month Alarm	0	
X Time (hh:mm:ss) Alarm	0 : 0 : 0	
ACPIAWAY Mode	[Disabled]	
AMD K8 Cool&Quiet Control	[Auto]	
Power on After Power fail	[Former-Sts]	

↑↓→← : Move Enter: Select +/-/PU/PD:Value F10:Save ESC:Exit F1: General Help
F5:Previous Values F7:Optimized Defaults

Parameter	Description	Options
ACPI Function	Use this item to enable or disable ACPI function.	Enabled Disabled
ACPI Suspend Type	Use this item to define how your system suspends. In the default, S3(STR), the suspend mode is a suspend to RAM, i.e., the system shut down with the exception of a refresh current to the system memory.	S1&S3
Power Management	This item is used to enable or disable users manually define power management.	User define
Video Off Method	This item defines how the video is powered down to save power. This item is set to DPMS(Display Power Management Software) by default.	DPMS Support
HDD Power Down	The IDE hard drive will spin down if it is not accessed within a specified length of time.	Disabled Enabled
HDD Down In Suspend	This item enables or disables whether the IDE hard drive to be down in suspend mode.	Disabled Enabled
Soft-Off by Power Button	Under ACPI(Advanced Configuration and Power management Interface) you can create a software power down. In a software power down, the system can be resumed by Wake Up Alarms. This item lets you install a software power down that is controlled by the power button on your system. If the item is set to Instant-Off, then the power button causes a software power down. If the item is set to Delay 4 Sec. Then you have to hold the power button down for four seconds to cause a software power down.	Delay 4 Sec

Parameter	Description	Options
WOL(PME#)/WOR(RI#)	This item specifies whether the system will be awakened from power saving modes when activity or input signal of the specified hardware peripheral or component is detected.	Disabled Enabled
USB Resume from S1/S3	This item allows users to enable or disable the USB device Wake-up from S1/S3 mode.	Enabled Disabled
PS2 K/B Resume from S1/S3	This item allows users to enable or disable the PS2 K/B Wake-up from S1/S3 mode.	Enabled Disabled
Resume by Alarm	This item allows users to enable or disable the alarm to wake up the system. If set to Enabled, users can specify the specific day of month and the exact time to power up the system.	Disabled Enabled
ACPI AWAY Mode	This item enables or disables the ACPI AWAY mode.	Disabled Enabled
AMD K8 Cool'n'Quiet control	This item helps the system to lower the frequency when CPU idles. When the frequency	Auto
Power on After Power fail	This item enables your computer to automatically restart or return to its operating status.	Former-Sts

PnP/PCI Feature

Phoenix-Award Workstation BIOS CMOS Setup Utility PnP/PCI Configurations

Init Display First	[PCI Ex]	Item Help
Reset Configuration Data	[Disabled]	
Resources Controlled By	[Auto(ESCD)]	Menu Level ▶
x IRQ Resources	Press Enter	
PCI/VGA Palette Snoop	[Disabled]	
** PCI Express relative items**		
Maximum Payload Size	[4096]	

↑ ↓ → ← : Move Enter: Select +/-/PU/PD:Value F10:Save ESC:Exit F1: General Help
F5:Previous Values F7:Optimized Defaults

Parameter	Description	Options
Init Display First	This item allows you to choose the primary display card.	PCIEx
Reset Configuration Data	If you enable this item and restart the system, any Plug and Play configuration data stored in the BIOS Setup is cleared from memory.	Enabled Disabled
Resources Controlled By	You should leave this item at the default Auto(ESCD). Under this setting, the system dynamically allocates resources to Plug and Play devices as they are required. If you cannot get a legacy ISA(Industry Standard Architecture) expansion card to work properly, you might be able to solve the problem by changing this item to Manual, and then opening up the IRQ Resources submenu.	Auto(ESCD)
IRQ Resources	In the IRQ Resources submenu, if you assign an IRQ to Legacy ISA, then that Interrupt Request Line is reserved for a legacy ISA expansion card. Press <ESC> to close the IRQ Resources submenu. In the Memory Resources submenu, use the first item Reserved Memory Base to set the start address of the memory you want to reserve for the ISA expansion card. Use the section item Reserved Memory Length to set the amount of reserved memory. Press <ESC> to close Memory Resources submenu.	
PCI/VGA Palette Snoop	This item is designed to overcome problems that can be caused by some non-standard VGA cards. This board includes a built-in VGA system that does not require palette snooping so you must leave this item disabled.	Enabled Disabled
Maximum Payload Size	This item specifies the maximum payload size for the PCI Express function.	4096

PC Health Status

Phoenix-Award WorkstationBIOS CMOS Setup Utility
PC Health Status

CPU Vcore	1.29V	Item Help
+3.3V	3.37V	
+5V	5.00V	Menu Level ▶
+12V	11.61V	
+5VSB	5.05V	
Voltage Battery	3.00V	
VDIMM	1.77V	
Current CPU Temperature	29°C	
Current SYSTEMTemperature	31°C	
CPU Fan Speed	5232 RPM	
System Fan Speed	0 RPM	
Shutdown Temperature	[Disabled]	
Warning Temperature	[Disabled]	
▶ Smart Fan Function	[Press Enter]	

↑↓→← : Move Enter: Select +/-/PU/PD:Value F10:Save ESC:Exit F1: General Help
F5:Previous Values F7:Optimized Defaults

The following table describes the parameters found in this menu:

Parameter	Description	Options
System Component Characteristics	These items allow users to monitor data provided by the BIOS on this motherboard. These fields can not be changed. <ul style="list-style-type: none"> <input type="checkbox"/> Vcore <input type="checkbox"/> Voltage Battery <input type="checkbox"/> CPU FAN Speed <input type="checkbox"/> System FAN Speed <input type="checkbox"/> Current System Temperature <input type="checkbox"/> Current CPU Temperature 	
CPU Shutdown Temperature	This item enables users to set the maximum temperature the system can reach before powering down.	60°C/140°F 70°C/158°F 80°C/176°F 90°C/194°F
Warning Temperature	This item lets you select the temperature at which you want the system to send out a warning message to the PC speakers of when the temperature goes beyond either limit.	Disabled
Smart FAN Control	SPU/SYS Smart Fan Function -- This item allows you to enable/disable the control of the CPU/system fan speed by changing by changing the fan parameter.	Press Enter

Set Supervisor/User Password

When this function is selected, the following message appears at the center of the screen to assist you in creating a password.

ENTER PASSWORD

Type the password, up to eight characters, and press<Enter>. The password typed now will clear any previously entered password from CMOS memory. You will be asked to confirm the password. Type the password again and press ,Enter>. You may also press <Esc> to abort the selection.

To disable password, just press <Enter> when you are prompted to enter password. A message will confirm the password being disabled. Once the password is disabled, the system will boot and you can enter BIOS Setup freely.

PASSWORD DISABLED

If you have selected "System" in "Security Option" of "BIOS Features Setup" menu, you will be prompted for the password every time the system reboots or any time you try to enter BIOS Setup.

If you have selected "Setup" at "Security Option" from "BIOS Features Setup" menu, you will be prompted for the password only when you enter BIOS Setup.

Supervisor Password has higher priority than User Password. You can use Supervisor Password when booting the system or entering BIOS Setup to modify all settings. Also you system or entering BIOS Setup but can not modify any setting if Supervisor Password is enabled.

Load Default Settings

Selecting the field loads the factory defaults for BIOS and Chipset Features which the system automatically detects. This option opens a dialog box that lets you install optimized defaults for all appropriate items in the Setup Utility. Press <OK> and then <Enter> to install the defaults. Press <Cancel> and then <Enter> to not install the defaults.

If you only want to install setup defaults for a specific option, select and display that option, and then press<F9>.

Save & Exit Setup

Highlight this item and press <Enter> to save the changes that you have made in the Setup Utility and exit the Setup Utility.

When the Save and Exit dialog box appears, press <Y> to save and exit, or press <N> to return to the main menu.

Exit Without Saving

Highlight this item and press <Enter> to discard any changes that you have made in the Setup Utility and exit the Setup Utility.

When the Exit Without Saving dialog box appears, press <Y> to discard changes and exit, or press <N> to return to the main menu.

NOTE: If you have made settings that you do not want to save, use the "Exit Without Saving" item and press <Y> to discard any changes you have made.

Machine Disassembly and Replacement

To disassemble the computer, you need the following tools:

- Wrist grounding strap and conductive mat for preventing electrostatic discharge.
- Wire cutter.
- Phillips screwdriver (may require different size).

NOTE: The screws for the different components vary in size. During the disassembly process, group the screws with the corresponding components to avoid mismatches when putting back the components.

General Information

Before You Begin

Before proceeding with the disassembly procedure, make sure that you do the following:

1. Turn off the power to the system and all peripherals.
2. Unplug the AC adapter and all power and signal cables from the system.

Disassembly Procedure

This section tells you how to disassemble the system when you need to perform system service. Please also refer to the disassembly video, if available.

CAUTION: Before you proceed, make sure you have turned off the system and all peripherals connected to it.

Standard Disassembly Process

1. Open the computer.

1-1. Place the system unit on a flat, steady surface.



1-2. Release the Lock-handle then slide the left side door out.

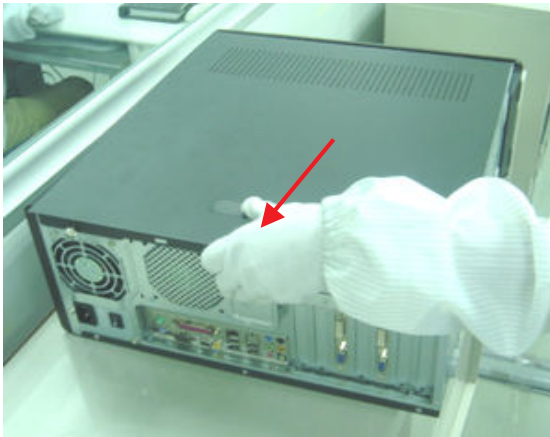

2. Disconnect the cables.

2-1. Disconnect the USB and Front AUDIO ASSY cables.

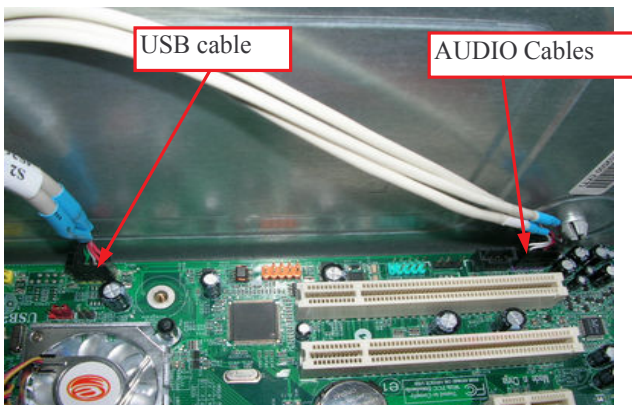

2-2. Disconnect the PA and PD power-cable from the MB connector.

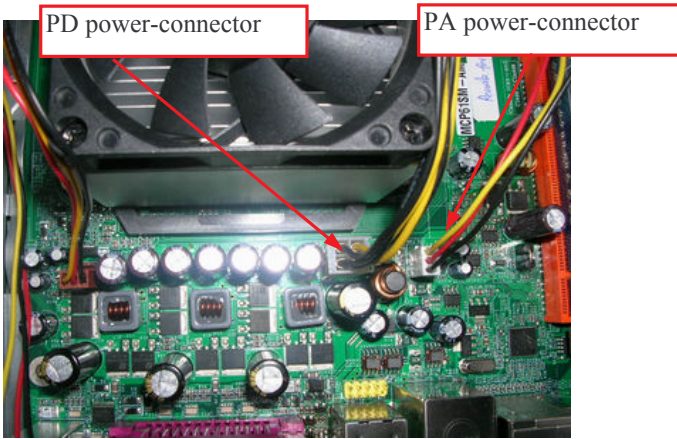

2-3 . Disconnect the P1 power-cable and ODD data cable from the MB connector.

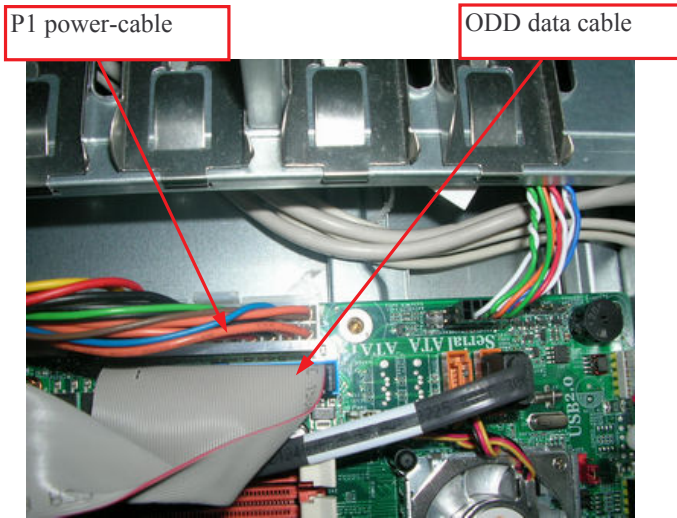

2-4 . Disconnect the ODD data cable and power-cable from the rear of ODD.

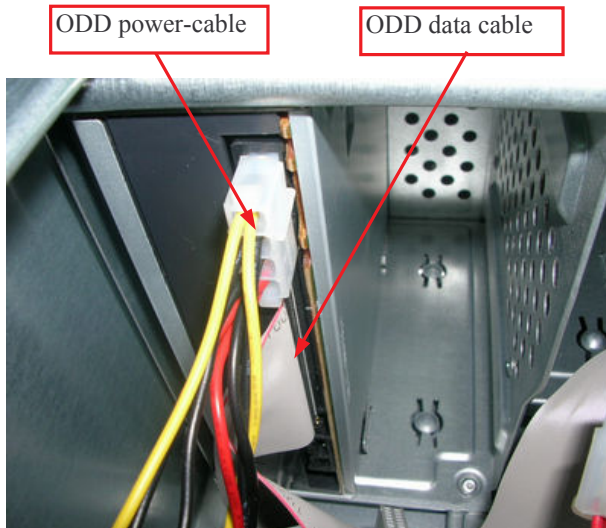

2-5 . Disconnect the HDD data cable and power-cable from the rear of HDD and MB

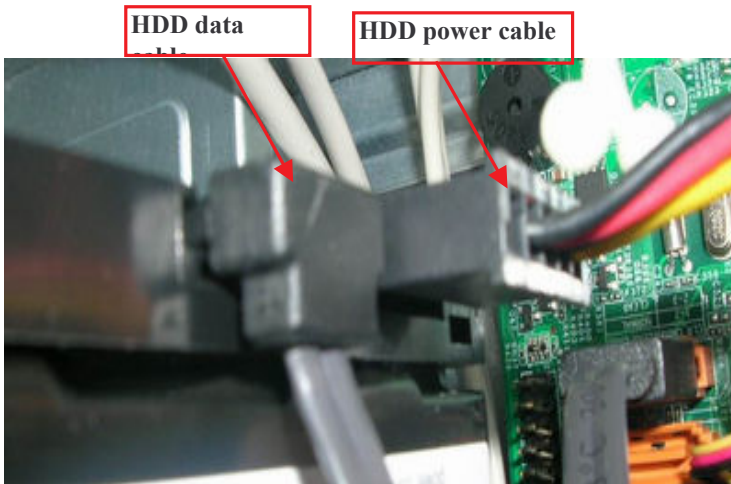

3. Detach the HDD and ODD.

3-1. Rail the HDD-holder shown bellow, then take the HDD out from the chassis.

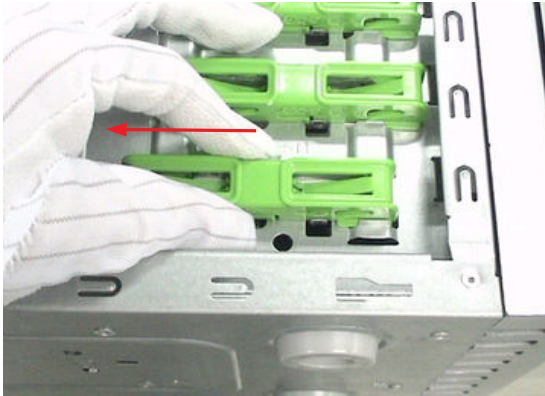

3-2. Release the three latches on the front bezel, then remove the front bezel.



3-3. Rail the ODD-holder shown bellow, then take the ODD out from the chassis.

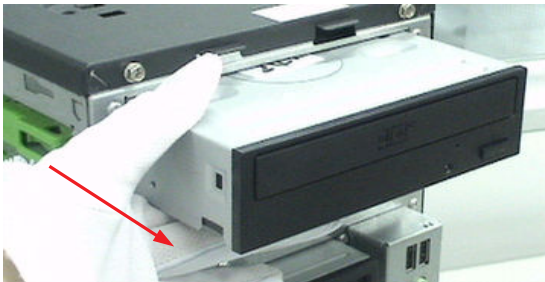

4. Detach the USB Module.

Release the screw shown bellow, then take off the USB module together with the USB&Audio cable.



5. Detach the CPU Cooler.

5-1. Disconnect the CPU Cooler power-cable shown bellow.

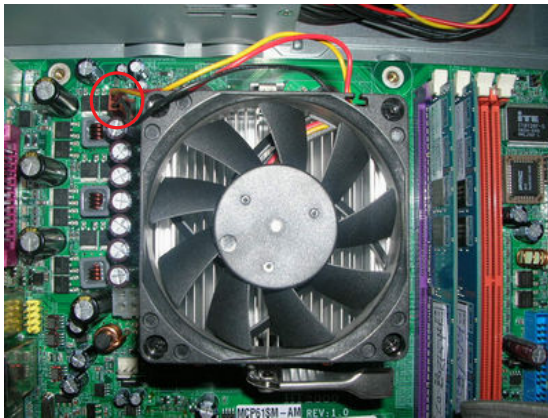

5-2. Release the CPU Cooler Latch then remove it.

Cooler power-

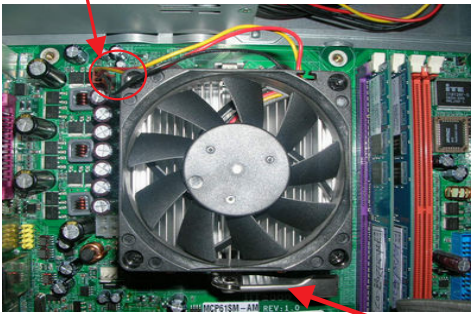

Cooler Locked latch

6. Remove the Memory.

Release the two latch shown bellow then remove the Memory.

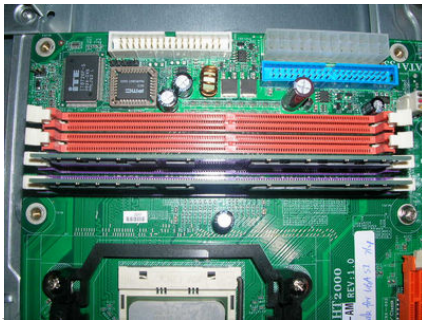

7. Remove the System Fan.

Release the four screws shown bellow then take off the fan.

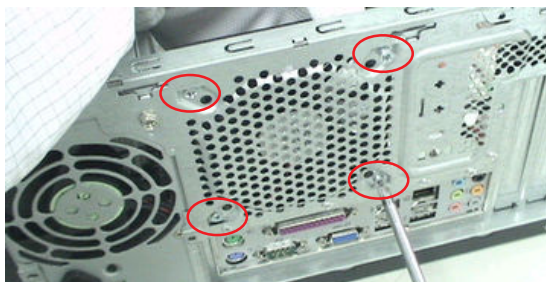

8. Remove the CPU.

Release the CPU Latch on the Socket then remove the CPU.



9. Remove the Motherboard.

Release the eight screws shown bellow then take off the MB.

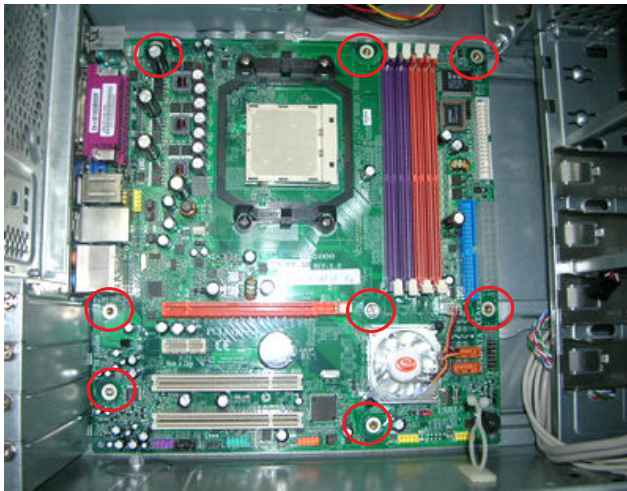

10. Remove the Power-supply.

Release the four screws shown bellow then take off the Power-supply.



Troubleshooting

Please refer to generic troubleshooting guide for troubleshooting information relating to following topics:

- Power-On Self-Test (POST)
- POST Check Points
- POST Error Messages List
- Error Symptoms List

Jumper and Connector Information

Jumper Setting

This section explains how to set jumpers for correct configuration of the mainboard.

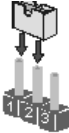

Setting Jumper

Use the motherboard jumpers to set system configuration options. Jumpers with more than one pin are numbered. When setting the jumpers, ensure that the jumper caps are placed on the correct pins.

Description	Illustration
<p>The illustrations show a 2-pin jumper. When the jumper cap is placed on both pins, the jumper is SHORT. If you remove the jumper cap, or place the jumper cap on just one pin, the jumper is OPEN.</p>	 <p>The illustration shows two pins. On the left, a grey jumper cap is placed over both pins, labeled "SHORT". On the right, the jumper cap is removed, leaving two pins standing, labeled "OPEN".</p>
<p>This illustration shows a 3-pin jumper. Pins 1 and 2 are SHORT</p>	 <p>The illustration shows three pins numbered 1, 2, and 3. A grey jumper cap is placed over pins 1 and 2, with two arrows pointing down to the pins, indicating they are shorted. Pin 3 is left open.</p>

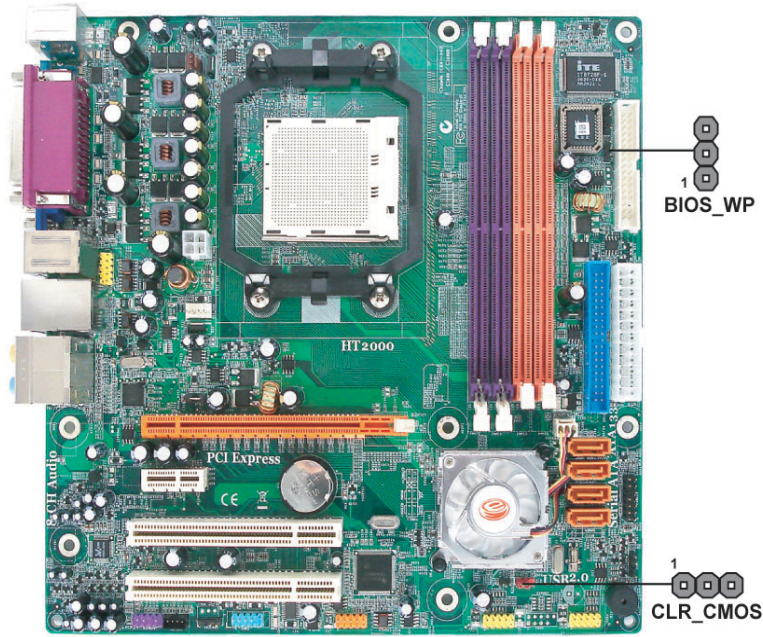
Checking Jumper Settings



Jumper	Type	Description	Setting(Default)	Illustration
CLR_CMOS	3-pin	CLEAR CMOS	1-2 : Clear 2-3 : Normal Before clearing the CMOS,make sure to turn off the system	<p>Clear CMOS</p>  <p>1</p>
BIOS_WP	3-pin	BIOS PROTECT	Open: Write Enable Short: Write Disable	 <p>1</p> <p>BIOS_WP</p>

Connecting Components

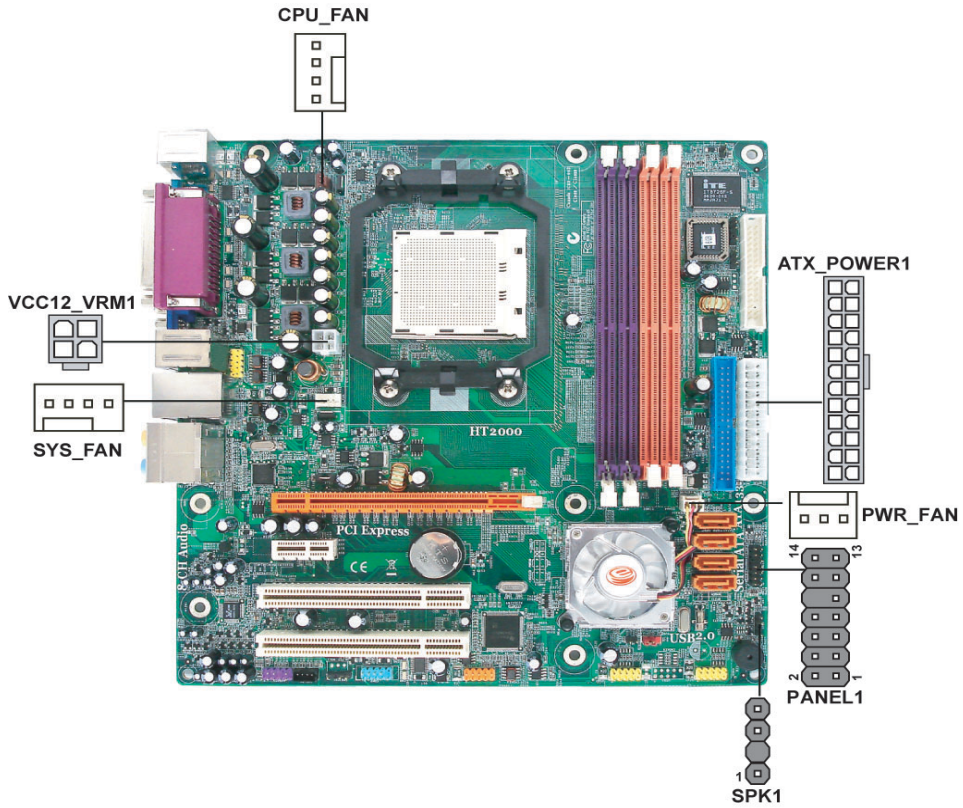

CPU_FAN/SYS_FAN

Pin	Signal Name	Function
1	GND	System Ground
2	+12V	Power +12V
3	Sense	Sensor
4	PWM	CPU FAN control

PWR_FAN

Pin	Signal Name	Function
1	GND	System Ground
2	+12V	Power +12V
3	Sense	Sensor

SPK1: Internal speaker

Pin	Signal Name
1	VCC
2	Key
3	GND
4	Signal

ATX Power

Pin	Signal Name	Pin	Signal Name
1	+3.3V	13	+3.3V
2	+3.3V	14	-12V
3	Ground	15	COM
4	+5V	16	PS_ON
5	Ground	17	COM
6	+5V	18	COM
7	Ground	19	COM
8	PWRGD	20	-5V
9	+5VSB	21	+5V
10	+12V	22	+5V
11	+12V	23	+5V
12	+3.3V	24	COM

ATX_12V

Pin	Signal Name
1	Ground
2	Ground
3	+12V
4	+12V

Front Panel Header

The front panel header (PANEL1) provides a standard set of switch and LED connectors commonly found on ATX or Micro ATX cases. Refer to the table below for information:

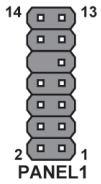
Illustration	Pin	Signal	Function	Pin	Signal	Function
	1	HDD+LED-	Hard disk LED+	2	SUS LED	*MSG LED+
	3	HDD+LED-	Hard disk LED-	4	SUS LED	*MSG LED-
	5	RST_SW_N	Reset Switch	6	PWR_SW_P	Power Switch(+)
	7	RST_SW_P	Reset Switch	8	PWR_SW_N	Power Switch(-)
	9	RSVD	Reserved	10	Key	No pin
	11	RSVD	Reserved	12	LAN LED	LAN LED(+)
	13	RSVD	Reserved	14	LAN LED	LAN LED(+)

(Top-View)

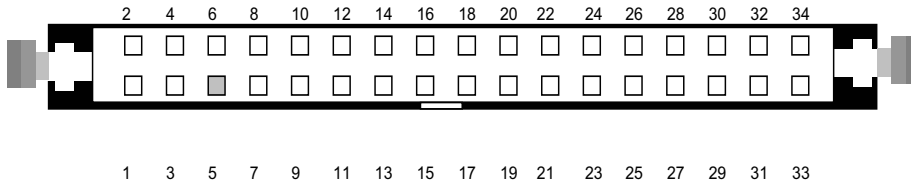

Pin	Signal Name	Pin	Signal Name
1	Ground	2	DRVDENO
3	Ground	4	HDL-
5	Keypin	6	DS3-
7	Ground	8	INDEX-
9	Ground	10	MTR0-
11	Ground	12	DS0-
13	Ground	14	DS1-
15	Ground	16	MTR1-
17	Ground	18	DIR-
19	Ground	20	STEP-
21	Ground	22	WDATA
23	Ground	24	WGATE-
25	Ground	26	TRK0-
27	Ground	28	WP-
29	Ground	30	RDATA
31	Ground	32	HDSEL-
33	Ground	34	DSKCHG-

IDE1 & IDE2

(Top-View)

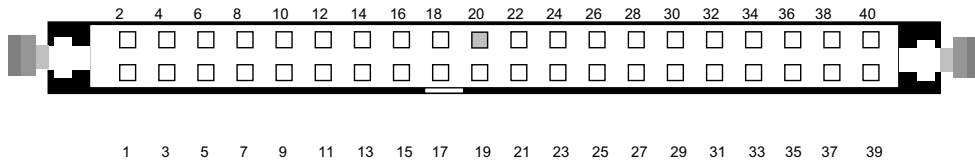

Pin	Signal Name	Pin	Signal Name
1	RESET-	2	Ground
3	DD7	4	DD8
5	DD6	6	DD9
7	DD5	8	DD10
9	DD4	10	DD11
11	DD3	12	DD12
13	DD2	14	DD13
15	DD1	16	DD14
17	DD0	18	DD15
19	Ground	20	Keypin
21	DMARQ	22	Ground
23	DIOW-	24	Ground
25	DIOR-	26	Ground
27	IORDY	28	PSYNC:CSEL
29	DMACK-	30	Ground
31	INTRQ	32	IOCS16-
33	DA1	34	PDIAG-
35	DA0	36	DA2
37	CS1FX-	38	CS3FX-
39	DASP-	40	Ground

Connecting the Optional Devices

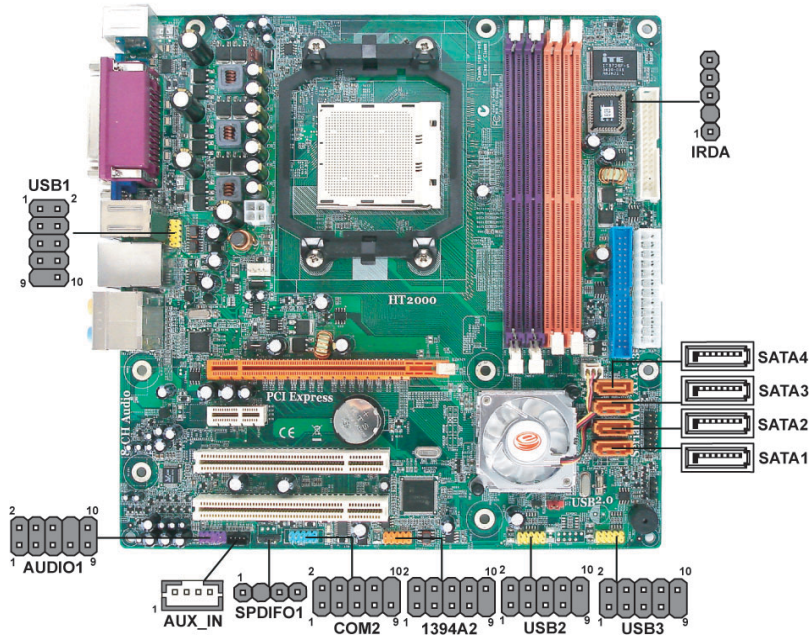

AUXIN1: Auxiliary in connector

Pin	Signal Name	Function
1	AUX_R	AUX In right channel
2	RET_R	Return Right Aux in
3	RET_L	Return Left Aux in
4	AUX_L	AUX In left channel

USB1~3: Front Panel USB headers

Pin	Signal Name	Function
1	USBPWR	Front panel USB power
2	USBPWR	Front panel USB power
3	USB_FP_P0-	USB port 0 negative signal
4	USB_FP_P1-	USB port 1 negative signal
5	USB_FP_P0+	USB port 0 positive signal
6	USB_FP_P1+	USB port 1 positive signal
7	GND	Ground
8	GND	Ground
9	Key	No pin
10	NC	Not connected

AUDIO1: Front Panel Audio Header

Pin	Signal Name	Function
1	PORT 1L	
2	AUD_GND	Ground used by analog audio circuits
3	PORT 1R	
4	PRESENCE#	
5	PORT 2R	
6	SENSE1_RETURN	
7	SENSE_SEND	
8	KEY	No pin
9	PORT 2L	
10	SENSE2_RETURN	

IRDA: Infrared header

Pin	Signal Name
1	VCC
2	No Pin
3	IRRX
4	Ground
5	IRTX

SPDIFO1 : SPDIF out header

Pin	Signal Name	Function
1	SPDIF	SPDIF digital output
2	+5VA	5V analog Power
3	Key	No pin
4	GND	Ground

SATA1~4: Serial ATA connectors

Pin	Signal Name	Pin	Signal Name
1	Ground	5	RX-
2	TX+	6	RX+
3	TX-	7	Ground
4	Ground		

1394A2: Onboard IEEE 1394a header

Pin	Signal Name	Pin	Signal Name
1	TPA+	6	TPB-
2	TPA-	7	Cable-Power
3	GND	8	Cable-Power
4	GND	9	Key pin
5	TPB+	10	GND

COM2: Onboard serial port header

Pin	Signal Name	Function
1	NDCBD	Data carry detect
2	NSINB	Serial Data In
3	NSOUTB	Serial Data out
4	NDTRB	Data terminal ready
5	GND	Ground
6	NDSRB	Data set ready
7	NRTSB	Request to send
8	NCTSB	Clear to send
9	NRIB	Ring Indicator
10	Key	No pin

Rear I/O Panel Connectors

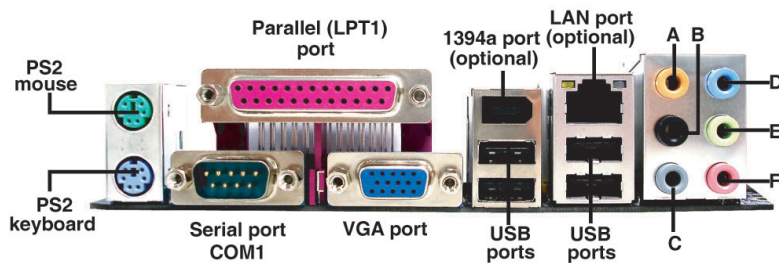

- PS2 Mouse: Use the PS/2 mouse port to connect a PS/2 pointing device
- PS2 Keyboard: Use the PS/2 keyboard port to connect a PS/2 keyboard
- Parallel Port(LPT1): Use LPT to connect printers or other parallel communication devices
- Serial Port(COM1): Use the COM port to connect serial devices such as mice, fax, or modems
- VGA Port: Connect your monitor to the VGA port
- LAN Port(optional): Connect and RJ-45 jack to the LAN port to connect your computer to the network

PSKBM1

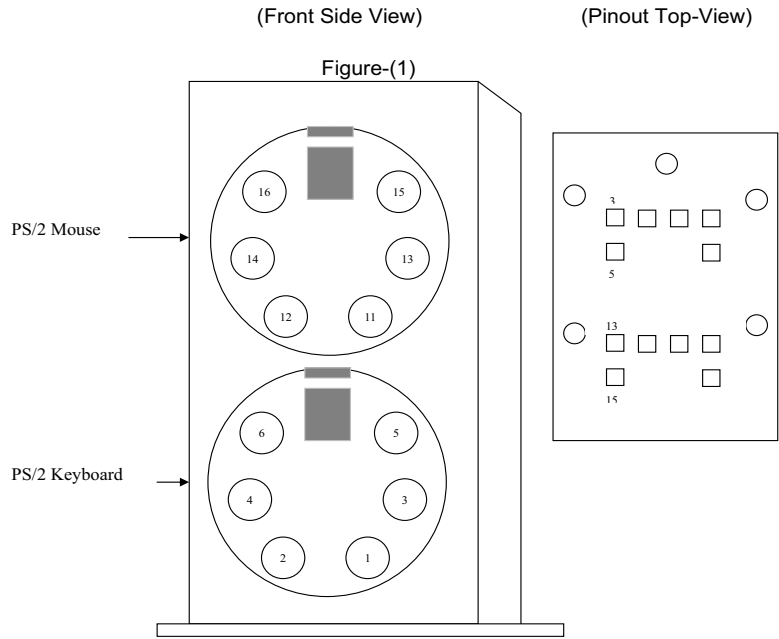

PS/2 Keyboard		PS/2 Mouse	
1	KBDATA	11	MADATA
2	NC	12	NC
3	Ground	13	Ground
4	VCC	14	VCC
5	KBCLK	15	MCLK
6	NC	16	NC

COM1

Illustration	Pin	Signal Name
<div style="display: flex; flex-direction: column; align-items: center;"> <div style="text-align: center;"> <p>Front Side View</p> </div> <div style="text-align: center;"> <p>Pinout Top-View</p> </div> <p>Figure-(2)</p> </div>	1	DCD
	2	RxD
	3	TxD
	4	DTR
	5	Ground
	6	DSR
	7	RTS
	8	CTS
	9	RI

Front Side View

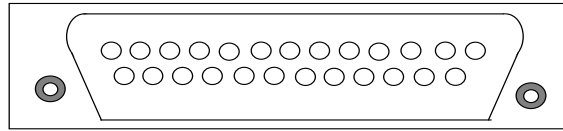

Pinout Top-View

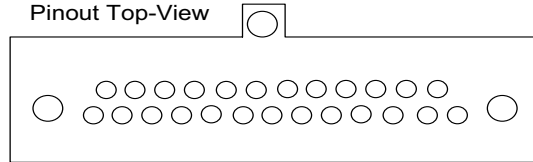

Pin	Signal Name	Pin	Signal Name
1	STROBE	13	SLCT
2	PD0	14	ALF
3	PD1	15	ERROR
4	PD2	16	INIT
5	PD3	17	SLCTIN
6	PD4	18	Ground
7	PD5	19	Ground
8	PD6	20	Ground
9	PD7	21	Ground
10	ACK	22	Ground
11	BUSY	23	Ground
12	PE	24	Ground
		25	Ground

USBLAN1

(Pinout Top-View)

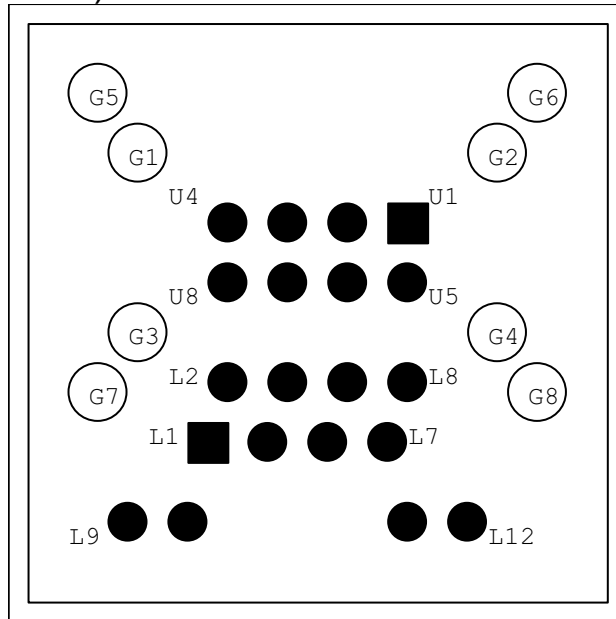

Pin	Signal Name	Pin	Signal Name
U1	VCC	G7	HOLE_LAN
U2	-DATA0	G8	HOLE_LAN
U3	+DATA0	L1	TX+
U4	GND	L2	TX-
U5	VCC	L3	RX+
U6	-DATA0	L4	NC
U7	+DATA0	L5	NC
U8	GND	L6	RX-
G1	HOLE_USB	L7	NC
G2	HOLE_USB	L8	NC
G3	HOLE_USB	L9	LINK
G4	HOLE_USB	L10	VCC
G5	HOLE_LAN	L11	ACT
G6	HOLE_LAN	L12	VCC

USB

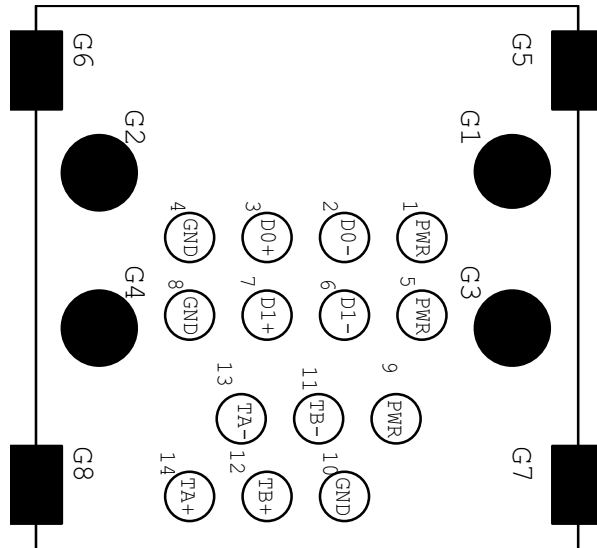

Pin	Signal Name	Pin	Signal Name
1	VCC	9	VP
2	-DATA0	10	VG
3	+DATA0	11	TPB-
4	GND	12	TPB+
5	VCC	13	TPA-
6	-DATA1	14	TPA+
7	+DATA1		
8	GND		
G1	HOLE_USB		
G2	HOLE_USB		
G3	HOLE_USB		
G4	HOLE_USB		

FRU (Field Replaceable Unit) List

This chapter gives you the FRU (Field Replaceable Unit) listing in global configurations of Aspire T180/E380 and AcerPower M8. Refer to this chapter whenever ordering for parts to repair or for RMA (Return Merchandise Authorization).

IMPORTANT: Please note WHEN ORDERING FRU PARTS, that you should check the most up-to-date information available on your regional web or channel. For whatever reasons a part number change is made, it will not be noted in the printed Service Guide. For ACER-AUTHORIZED SERVICE PROVIDERS, your Acer office may have a DIFFERENT part number code to those given in the FRU list of this printed Service Guide. You MUST use the local FRU list provided by your regional Acer office to order FRU parts for repair and service of customer machines.

IMPORTANT: Please note that Acer Corporation sells only the parts listed in the following table. Please be reminded that though some parts are disassembled in Chapter 3 for demonstration purpose, Acer Corporation does not provide these parts.

NOTE: To scrap or to return the defective parts, you should follow the local government ordinance or regulations on how best to dispose it, or follow the rules set by your regional Acer office on how to return it. You can access to the website for the latest Parts version <http://aicsl.acer.com.tw/spl/>

NOTE: The final version of SPL will be released later.

Exploded Diagram

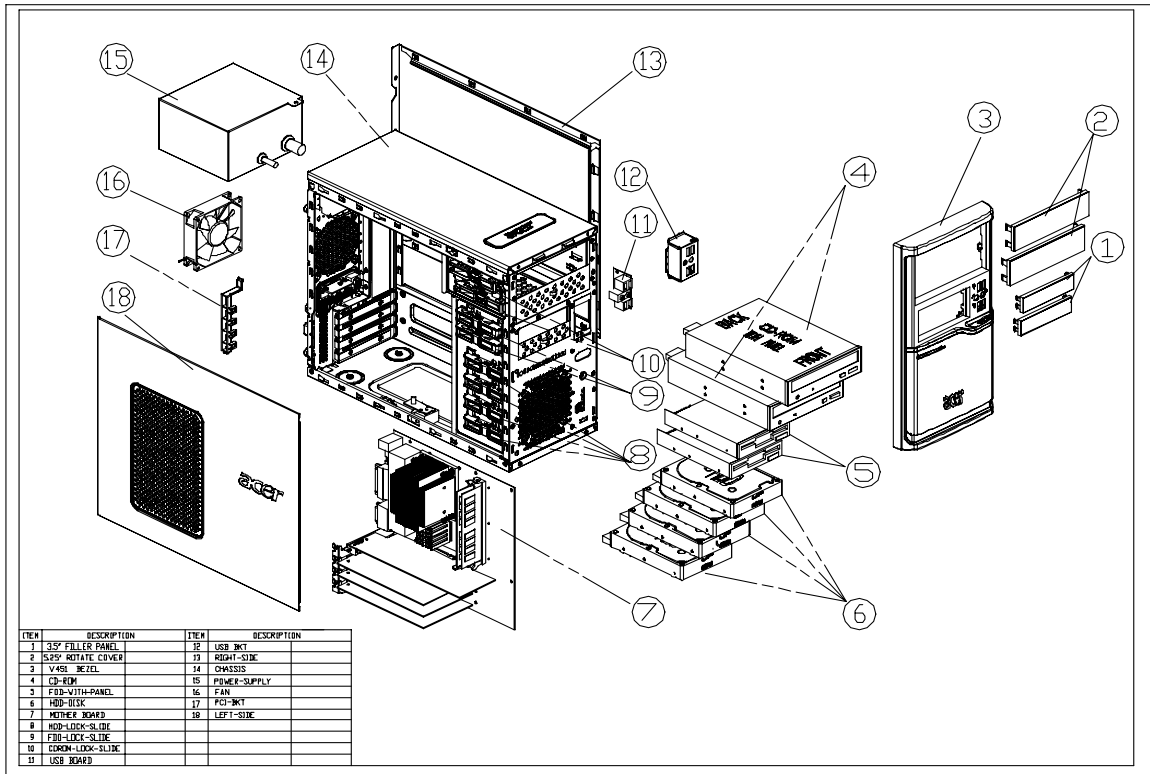

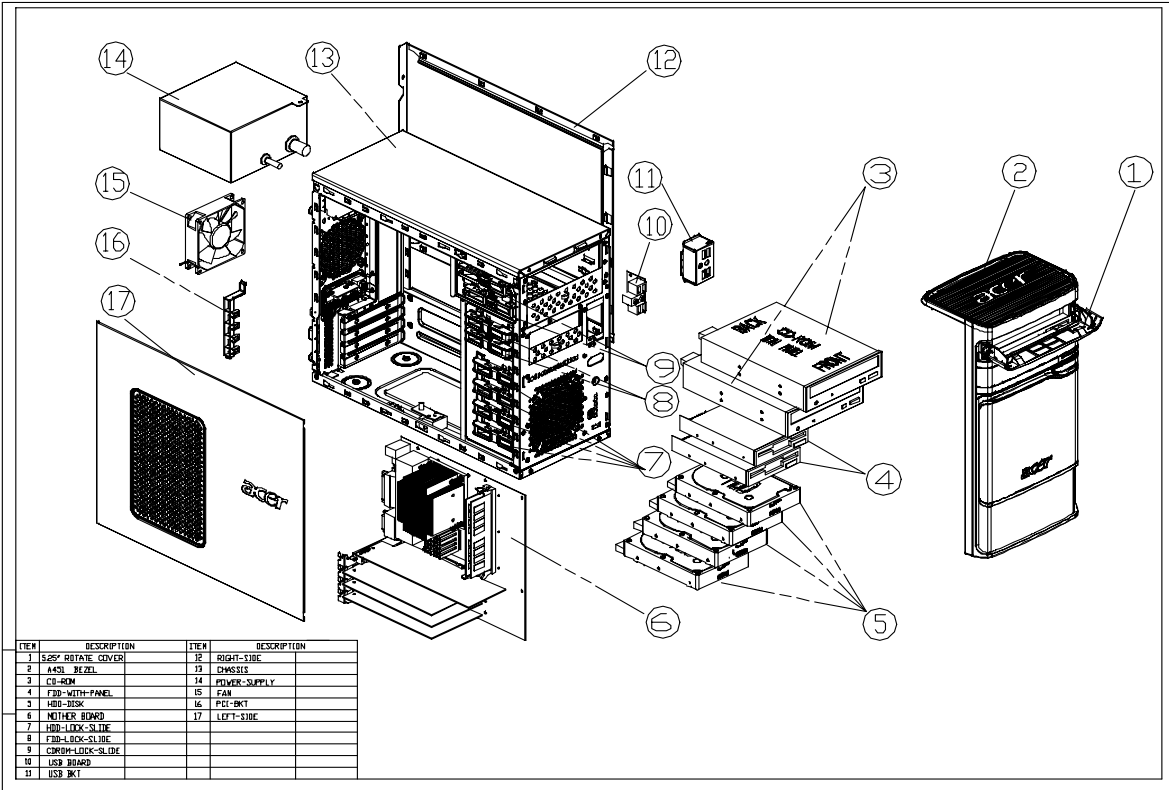

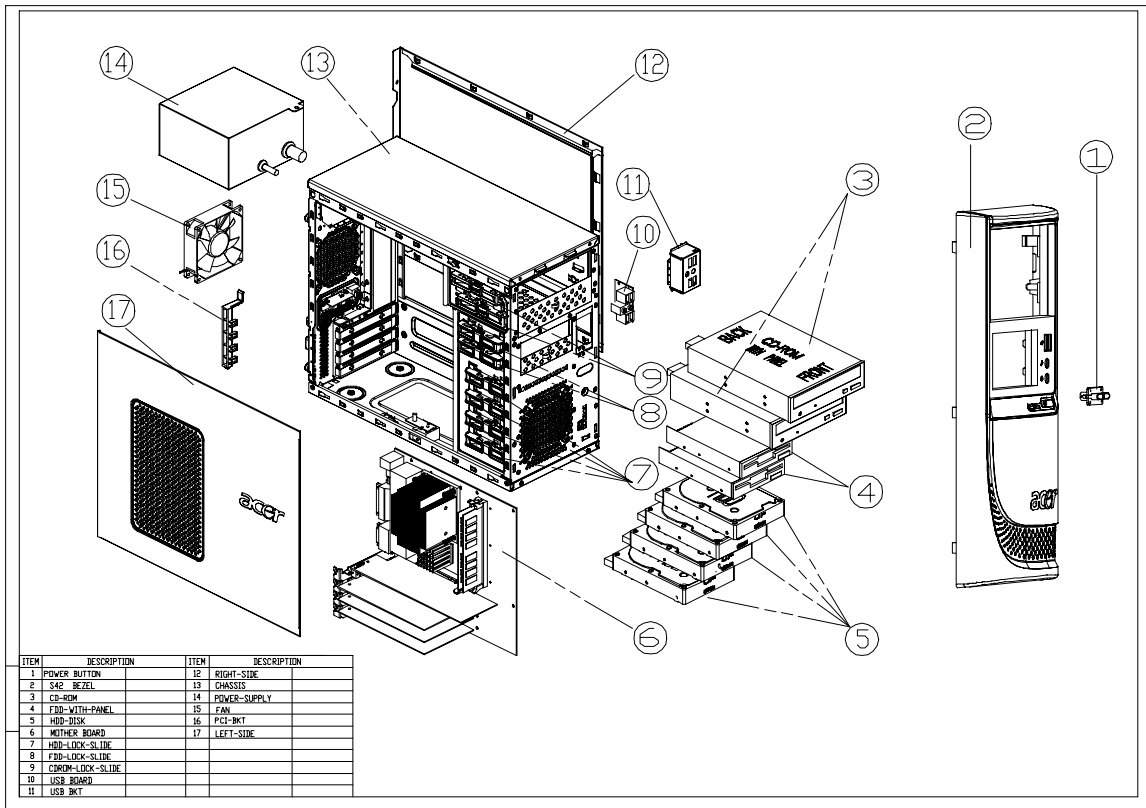

ITEM	DESCRIPTION	ITEM	DESCRIPTION
1	POWER BUTTON	12	RIGHT-SIDE
2	S&C BEZEL	13	CHASSIS
3	CD-ROM	14	POWER-SUPPLY
4	FDD-WITH-PANEL	15	FAN
5	HDD-DISK	16	PCI-BKT
6	MOTHER BOARD	17	LEFT-SIDE
7	HDD-LOCK-SLIDE		
8	FDD-LOCK-SLIDE		
9	CDROM-LOCK-SLIDE		
10	USB BOARD		
11	USB BKT		

FRU List

The FRU list will be updated later.