

English
Français
Deutsch
Italiano
Español
Português
Nederlands
Norsk
Dansk
Svenska
Suomi
Русский
Polski
Magyar
Čeština
Slovenčina
Slovenski
Hrvatski
Română
Български
Eesti
Latviski
Lietuviškai
Ελληνικά
Türkçe
日本語
한국어
繁體中文
简体中文
Bahasa Indonesia
ไทย

Contents

TravelMate 5740/5740Z/5340 Series

Quick Guide

© 2010 All Rights Reserved.

TravelMate 5740/5740Z/5340 Series Quick Guide
Original Issue: 03/2010

TravelMate 5740/5740Z/5340 Series Notebook PC

Model number: _____

Serial number: _____

Date of purchase: _____

Place of purchase: _____

Acer and the Acer logo are registered trademarks of Acer Incorporated. Other companies' product names or trademarks are used herein for identification purposes only and belong to their respective companies.

First things first

We would like to thank you for making an Acer notebook your choice for meeting your mobile computing needs.

Your guides

To help you use your Acer notebook, we have designed a set of guides:

First off, the **setup poster** helps you get started with setting up your computer.

The **TravelMate Series Generic User Guide** contains useful information applying to all models in the TravelMate product series. It covers basic topics such as using the keyboard and audio, etc. Please understand that due to its nature, the **AcerSystem User Guide** mentioned below will occasionally refer to functions or features which are only contained in certain models of the series, but not necessarily in the model you purchased. Such instances are marked in the text with language such as "only for certain models".

This **Quick Guide** introduces you to the basic features and functions of your new computer. For more on how your computer can help you to be more productive, please refer to the **AcerSystem User Guide**. This guide contains detailed information on such subjects as system utilities, data recovery, expansion options and troubleshooting. In addition it contains warranty information and the general regulations and safety notices for your notebook. It is available in Portable Document Format (PDF) and comes preloaded on your notebook. Follow these steps to access it:

- 1 Click on **Start > All Programs > AcerSystem**.
- 2 Click on **AcerSystem User Guide**.



Note: Viewing the file requires Adobe Reader. If Adobe Reader is not installed on your computer, clicking on **AcerSystem User Guide** will run the Adobe Reader setup program first. Follow the instructions on the screen to complete the installation. For instructions on how to use Adobe Reader, access the **Help and Support** menu.







Your Acer notebook tour

After setting up your computer as illustrated in the **Just for Starters...** poster, let us show you around your new Acer notebook.

Top view



#	Icon	Item	Description
1		Acer Crystal Eye webcam	Web camera for video communication (only for certain models).
2		Display screen	Also called Liquid-Crystal Display (LCD), displays computer output (Configuration may vary by models).











#	Icon	Item	Description
3		Speakers	Front left and front right speakers deliver stereo audio output.
4		Keyboard	For entering data into your computer.
5		Touchpad	Touch-sensitive pointing device which functions like a computer mouse.
6		Power indicator ¹	Indicates the computer's power status.
		Battery indicator ¹	Indicates the computer's battery status. 1. Charging: The light shows amber when the battery is charging. 2. Fully charged: The light shows blue when in AC mode.
7		Click buttons (left and right)	The left and right buttons function like the left and right mouse buttons.
8		Palmrest	Comfortable support area for your hands when you use the computer.
9		HDD	Indicates when the hard disk drive is active.
		Communication indicator	Indicates the computer's wireless connectivity device status.
10		Power switch	Turns the computer on and off.
11		Microphone	Internal microphone for sound recording.

1. The front panel indicators are visible even when the computer cover is closed.

Hotkeys

The computer employs hotkeys or key combinations to access most of the computer's controls like screen brightness and volume output.

To activate hotkeys, press and hold the **<Fn>** key before pressing the other key in the hotkey combination.

Hotkey	Icon	Function	Description
<Fn> + <F3>		Communication	Enables / disables the computer's communication devices. (Communication devices may vary by configuration.)
<Fn> + <F4>		Sleep	Puts the computer in Sleep mode.
<Fn> + <F5>		Display toggle	Switches display output between the display screen, external monitor (if connected) and both.
<Fn> + <F6>		Display off	Turns the display screen backlight off to save power. Press any key to return.
<Fn> + <F7>		Touchpad toggle	Turns the touchpad on and off.
<Fn> + <F8>		Speaker toggle	Turns the speakers on and off.
<Fn> + <Δ>		Volume up	Increases the sound volume.
<Fn> + <∇>		Volume down	Decreases the sound volume.
<Fn> + <∠>		Brightness up	Increases the screen brightness.
<Fn> + <∠∇>		Brightness down	Decreases the screen brightness.

Closed front view



#	Icon	Item	Description
1		Power indicator ¹	Indicates the computer's power status.
		Battery indicator ¹	Indicates the computer's battery status. 1. Charging: The light shows amber when the battery is charging. 2. Fully charged: The light shows blue when in AC mode.
2		Multi-in-1 card reader	Accepts Secure Digital (SD), MultiMediaCard (MMC), Memory Stick (MS), Memory Stick PRO (MS PRO), xD-Picture Card (xD). Note: Push to remove/install the card. Only one card can operate at any given time.







Rear view

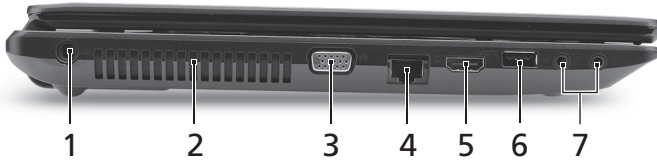

#	Icon	Item	Description
1		Battery	Provides power for the computer to be used while unplugged.



Left view



#	Icon	Item	Description
1		DC-in jack	Connects to an AC adapter.
2		Ventilation slots	Enable the computer to stay cool, even after prolonged use.
3		External display (VGA) port	Connects to a display device (e.g., external monitor, LCD projector).
4		Ethernet (RJ-45) port	Connects to an Ethernet 10/100/1000-based network.
5		HDMI port	Supports high-definition digital video connections.
6		USB 2.0 port	Connects to USB 2.0 devices (e.g., USB mouse, USB camera).
7		Microphone-in jack	Accepts inputs from external microphones.
		Headphones/speaker/line-out jack	Connects to audio line-out devices (e.g., speakers, headphones).

Right view





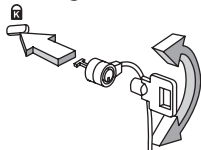

#	Icon	Item	Description
1		USB 2.0 port	Connects to USB 2.0 devices (e.g., USB mouse, USB camera).
2		Optical drive	Internal optical drive; accepts CDs or DVDs.
3		Optical disk access indicator	Lights up when the optical drive is active.
4		Optical drive eject button	Ejects the optical disk from the drive.
5		Emergency eject hole	Ejects the optical drive tray when the computer is turned off. Note: Insert a paper clip to the emergency eject hole to eject the optical drive tray when the computer is off.
6		Kensington lock slot	Connects to a Kensington-compatible computer security lock. Note: Wrap the computer security lock cable around an immovable object such as a table or handle of a locked drawer. Insert the lock into the notch and turn the key to secure the lock. Some keyless models are also available.

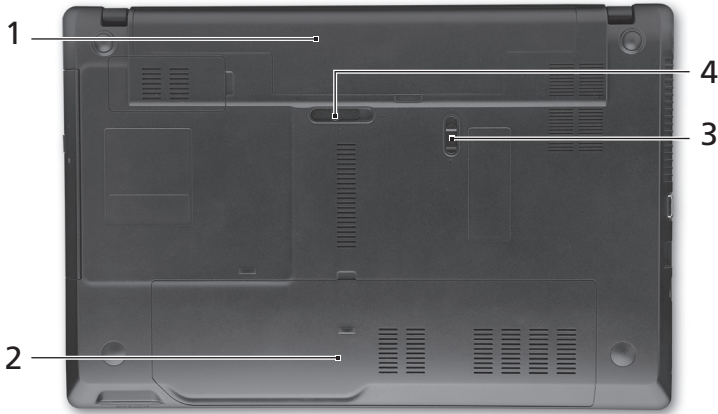

Base view



#	Icon	Item	Description
1		Battery bay	Houses the computer's battery pack.
2		Hard disk bay	Houses the computer's hard disk (secured with screws).
		Memory compartment	Houses the computer's main memory.
3		Battery lock	Locks the battery in position.
4		Battery release latch	Releases the battery for removal.

Environment	<ul style="list-style-type: none"> Temperature: <ul style="list-style-type: none"> Operating: 5 °C to 35 °C Non-operating: -20 °C to 65 °C Humidity (non-condensing): <ul style="list-style-type: none"> Operating: 20% to 80% Non-operating: 20% to 80%
-------------	--

Gamme TravelMate 5740/ 5740Z/5340

Guide rapide

© 2010 Tous droits réservés.

Guide rapide de la gamme TravelMate 5740/5740Z/5340

Première publication : 03/2010

Ordinateur notebook de la gamme TravelMate 5740/5740Z/5340

Modèle : _____

No. de série : _____

Date d'achat : _____

Lieu d'achat : _____

Pour commencer

Nous désirons vous remercier d'avoir fait d'un notebook Acer votre choix pour répondre à vos besoins informatiques mobiles.

Vos guides

Pour vous aider à utiliser votre notebook Acer, nous avons conçu plusieurs guides :

Tout d'abord, le **poster de configuration** vous aide à démarrer par la configuration de votre ordinateur.

Le **Guide Utilisateur Générique de la gamme TravelMate** contient des informations utiles qui s'appliquent à tous les modèles de la gamme des produits TravelMate. Il couvre les notions de base, telles que l'utilisation du clavier et du son, etc. Merci de comprendre que par sa nature, le **Guide Utilisateur AcerSystem** mentionné ci-dessous fera parfois référence à des fonctions ou des caractéristiques qui ne sont pourvues que chez certains modèles de la gamme, mais pas nécessairement dans le modèle que vous avez acheté. Ces cas sont marqués dans le texte avec des mentions telles que «seulement pour certains modèles».

Le **Guide rapide** vous présente les fonctionnalités et fonctions de base de votre ordinateur. Pour plus d'information sur l'aide que peut vous apporter pour être plus productif, veuillez vous reporter au **Guide Utilisateur AcerSystem**. Ce guide contient des informations détaillées sur des sujets tels que les utilitaires systèmes, la récupération des données, les options d'extension et le dépannage. De plus, il contient des informations de garantie et les réglementations générales et les avis de sécurité pour votre notebook. Il est disponible au format PDF (Portable Document Format) et est préchargé sur votre notebook. Procédez comme suit pour y accéder :

- 1 Cliquez sur **Démarrer > Tous les programmes > AcerSystem**.
- 2 Cliquez sur le **Guide utilisateur AcerSystem**.



.....







Remarque : L'affichage du fichier nécessite Adobe Reader. Si Adobe Reader n'est pas installé dans votre ordinateur, le clic sur le **Guide utilisateur AcerSystem** va exécuter le programme d'installation d'Adobe Reader. Suivez les instructions à l'écran pour terminer l'installation. Pour des instructions sur l'utilisation de Adobe Reader, accédez au menu **Aide et Support**.

Votre visite guidée du notebook Acer

Après avoir configuré votre ordinateur comme illustré dans le poster **Pour partir du bon pied...**, nous allons vous faire explorer votre nouveau notebook Acer.

Vue supérieure













#	Icône	Élément	Description
1		Webcam Acer Crystal Eye	Webcam pour communication video (seulement pour certains modèles).
2		Écran d'affichage	Également appelé écran LCD (Liquid Crystal Display), affiche les données de l'ordinateur (La configuration peut varier en fonction des modèles).
3		Haut-parleurs	Les haut-parleurs avant gauche et droit fournissent un signal audio stéréo.
4		Clavier	Pour l'entrée des informations dans votre ordinateur.
5		Touchpad	Périphérique de pointage sensible au touché qui fonctionne comme une souris.
6		Indicateur d'alimentation ¹	Indique l'état d'alimentation de l'ordinateur.
		Indicateur de batterie ¹	Indique l'état de la pile de l'ordinateur. 1. Charge : La lumière est orange lorsque la pile se recharge. 2. Pleine charge : La diode est bleue en mode secteur.
7		Boutons (gauche et droit)	Le bouton gauche et le bouton droit fonctionnent comme le bouton gauche et le bouton droit d'une souris.
8		Repose mains	Zone de support confortable pour vos mains lorsque vous utilisez l'ordinateur.
9		HDD	Indique l'activité du disque dur.
		Indicateur de communication	Indique le statut du périphérique de connectivité sans fil de l'ordinateur.
10		Interrupteur d'alimentation	Met l'ordinateur sous tension et hors tension.
11		Microphone	Microphone interne pour l'enregistrement sonore.

1. Les indicateurs du panneau avant sont visibles même lorsque l'écran LCD est refermé.

Touches spéciales



L'ordinateur emploie des touches spéciales (combinaisons de touches) pour accéder à la plupart des contrôles de l'ordinateur comme la luminosité de l'écran et le volume sonore.

Pour activer les touches spéciales, appuyez et maintenez la touche **<Fn>** avant d'appuyer sur l'autre touche dans la combinaison de la touche spéciale.

Touche spéciale	Icône	Fonction	Description
<Fn> + <F3>		Communication	Active/désactive les périphériques de communication de l'ordinateur. (Les périphériques de communication peuvent varier en fonction de la configuration.)
<Fn> + <F4>		Sommeil	Place l'ordinateur en mode de Sommeil.
<Fn> + <F5>		Choix de l'affichage	Permet de permuter l'affichage entre l'écran d'affichage, le moniteur externe (s'il est connecté) et les deux.
<Fn> + <F6>		Affichage éteint	Désactive le rétro éclairage de l'écran pour économiser l'énergie. Appuyez sur une touche pour le rallumer.
<Fn> + <F7>		Touchpad	Met l'ordinateur sous tension et hors tension.
<Fn> + <F8>		Haut-parleur	Active et désactive les haut-parleurs.
<Fn> + <Δ>		Volume +	Augmente le volume sonore.
<Fn> + <▽>		Volume -	Diminue le volume sonore.
<Fn> + <Δ>		Accroissement de la luminosité	Augmente la luminosité de l'écran.
<Fn> + <▽>		Décroissement de la luminosité	Diminue la luminosité de l'écran.

Vue frontale fermée



#	Icône	Élément	Description
1		Indicateur d'alimentation ¹	Indique l'état d'alimentation de l'ordinateur.
		Indicateur de batterie ¹	Indique l'état de la pile de l'ordinateur. 1. Charge : La lumière est orange lorsque la pile se recharge. 2. Pleine charge : La diode est bleue en mode secteur.
2		Lecteur de cartes multiples en un	Accepte une carte mémoire Secure Digital (SD), MultiMediaCard (MMC), Memory Stick (MS), Memory Stick Pro (MS PRO), et xD-Picture (xD). Remarque : Poussez pour retirer/installer la carte. Seule une carte peut fonctionner à un moment donné.







Vue arrière

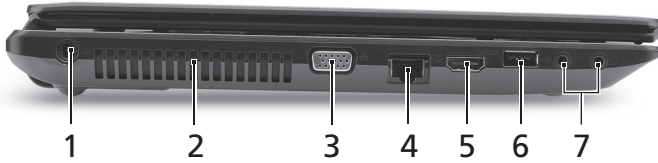

#	Icône	Élément	Description
1		Batterie	Fournit à l'ordinateur une alimentation électrique quand celui-ci n'est pas branché sur le secteur.

Vue gauche



#	Icône	Élément	Description
1		Prise d'alimentation	Se connecte à l'adaptateur secteur.
2		Fentes de ventilation	Permettent à l'ordinateur de rester froid, même après une longue utilisation.
3		Port d'affichage (VGA) externe	Se connecte à un périphérique d'affichage (p.ex. un moniteur externe, un projecteur LCD).
4		Port Ethernet RJ-45	Se connecte à un réseau Ethernet 10/100/1000 Base.
5		Port HDMI	Prend en charge les connexions vidéo numériques haute définition.
6		Port USB 2.0	Se connecte à des périphériques USB 2.0 (p.ex. une souris USB, une caméra USB).
7		Prise d'entrée microphone	Accepte les entrées de microphones externes.
		Prise de sortie audio/haut-parleurs/casque	Se connecte à des périphériques audio en sortie (p.ex. haut-parleurs ou un casque stéréo).

Vue droite





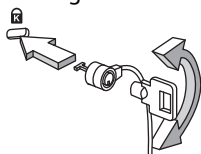

#	Icône	Élément	Description
1		Port USB 2.0	Se connecte à des périphériques USB 2.0 (p.ex. une souris USB, une caméra USB).
2		Lecteur optique	Lecteur optique interne, accepte les CD ou les DVD.
3		Indicateur d'accès du disque optique	S'allume lorsque le lecteur optique est actif.
4		Bouton d'éjection du lecteur optique	Éjecte le disque optique du lecteur.
5		Trou d'éjection d'urgence	Éjecte le plateau du lecteur optique lorsque l'ordinateur est hors tension. Remarque : Insérez un trombone dans le trou d'éjection d'urgence pour éjecter le plateau du lecteur optique même quand l'ordinateur est éteint.
6		Fente pour cadenas Kensington	Se connecte à un cadenas de sécurité pour ordinateur Kensington. Remarque : Enroulez le câble du cadenas de sécurité pour ordinateur autour d'une table, de la poignée d'un tiroir verrouillé, ou de tout autre objet fixe. Insérez le cadenas dans l'encoche et tournez la clef pour verrouiller le cadenas. Certains modèles ne possèdent pas de clef.

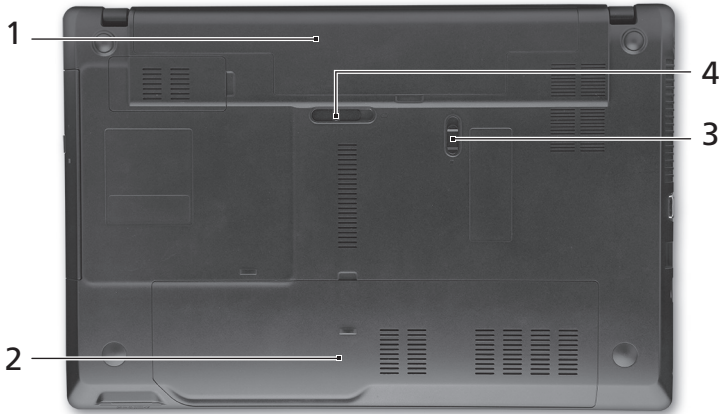

Vue de la base



#	Icône	Élément	Description
1		Baie de la batterie	Contient la batterie de l'ordinateur.
2		Baie du disque dur	Contient le disque dur de l'ordinateur (fixé avec des vis).
		Compartment mémoire	Contient la mémoire principale de l'ordinateur.
3		Verrou de la batterie	Verrouille la batterie en position.
4		Loquet de libération de la batterie	Libère la batterie pour le retrait.

- Environnement
- Température :
 - En marche : 5°C à 35°C
 - À l'arrêt : -20°C à 65°C
 - Humidité (sans condensation) :
 - En marche : 20% à 80%
 - À l'arrêt : 20% à 80%

TravelMate 5740/ 5740Z/5340 Serie

Kurzanleitung

© 2010 Alle Rechte vorbehalten.

Kurzanleitung für TravelMate 5740/5740Z/5340 Serie
Originalausgabe: 03/2010

Notebook-PC der TravelMate 5740/5740Z/5340 Serie

Modellnummer: _____

Seriennummer: _____

Kaufdatum: _____

Kaufort: _____

Das Wichtigste zuerst

Wir möchten uns bei Ihnen dafür bedanken, dass Sie sich in Bezug auf mobilen Computerbedarf für ein Acer-Notebook entschieden haben.

Hilfen

Als Hilfe für Sie beim Benutzen Ihres Acer-Notebooks haben wir einen Satz von Richtlinien aufgestellt:

Zuallererst hilft Ihnen das **Übersichtsblättchen**, den Computer das erste Mal in Betrieb zu nehmen.

Die ausgedruckte **Allgemeine Bedienungsanleitung für die TravelMate Serie** enthält hilfreiche Informationen, die sich auf alle Modelle der TravelMate-Produktserien beziehen. Es werden grundlegende Themen wie z. B. die Verwendung der Tastatur, Audio usw. behandelt. Das **Acer System Anwendungs-Handbuch** kann sich möglicherweise auf Funktionen und Leistungsmerkmale bestimmter Modelle der Serie beziehen, die für das von Ihnen gekaufte Modell u. U. nicht zur Verfügung stehen. Solche Stellen sind im Text mit "Nur für bestimmte Modelle" gekennzeichnet.

Die **Kurzanleitung** stellt Ihnen die grundlegenden Features und Funktionen Ihres neuen Computers vor. Für weitere Informationen dazu, wie Ihnen Ihr Computer helfen kann, noch produktiver zu arbeiten, lesen Sie bitte die **AcerSystem Benutzeranleitung**. Dieses Benutzerhandbuch enthält detaillierte Informationen zu Themen wie z.B. System-Programmen, Datenwiederherstellung, Erweiterungsoptionen und Problembhebung. Darüber hinaus enthält es Informationen zur Garantie und allgemeine Bestimmungen und Sicherheitshinweise zu Ihrem Notebook. Das Benutzerhandbuch steht in PDF (Portable Document Format) zur Verfügung und ist bereits in Ihrem Notebook installiert. Befolgen Sie die nachfolgenden Schritte zum Öffnen :

- 1 Klicken Sie auf **Start > Alle Programme > AcerSystem**.
- 2 Klicken Sie auf **AcerSystem User's Guide**.



.....





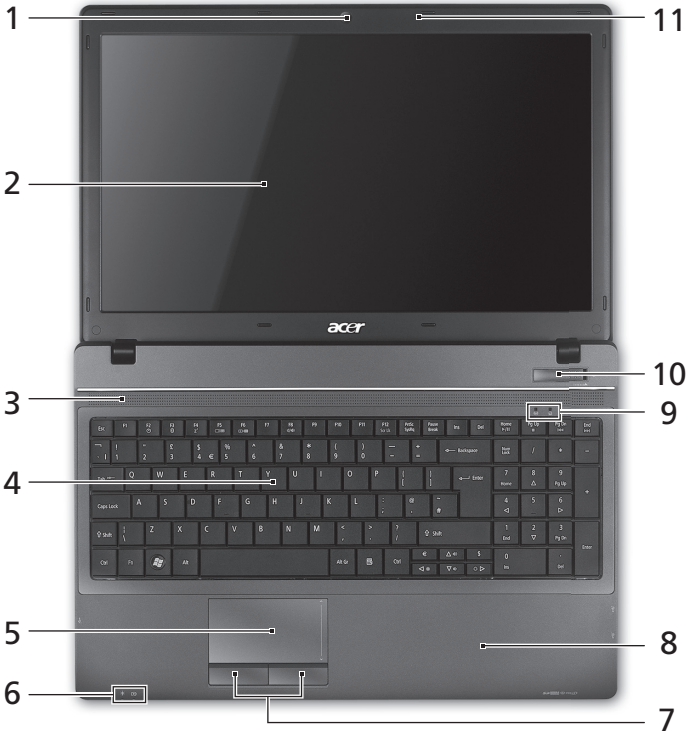

Hinweis: Zum Betrachten der Datei muß Adobe Reader installiert sein. Wenn Adobe Reader nicht auf Ihrem Computer installiert ist, wird durch Klicken auf **AcerSystem User's Guide** zuerst das Setup-Programm von Adobe Reader ausgeführt. Folgen Sie zur Durchführung der Installation den Anweisungen auf dem Bildschirm. Hinweise über die Verwendung von Adobe Reader finden Sie im Menü **Hilfe und Support**.

Ihre Acer-Notebook-Tour

Nachdem Sie Ihren Computer wie in Poster **Für den Anfang...** gezeigt aufgestellt haben, lassen Sie uns nun Ihr neues Acer-Notebook vorstellen.

Ansicht von oben













#	Symbol	Element	Beschreibung
1		Acer Crystal Eye Webcam	Web-Kamera für Videokommunikation (Nur für bestimmte Modelle).
2		Anzeigebildschirm	Wird auch als LCD (Liquid-Crystal-Display) bezeichnet. Zeigt die Ausgabe des Computers an (Konfiguration kann sich von Modell zu Modell unterscheiden).
3		Lautsprecher	Die Lautsprecher links und rechts vorne geben Stereosound aus.
4		Tastatur	Dient der Eingabe von Daten in den Computer.
5		Touchpad	Berührungssensibles Zeigegerät, das die gleichen Funktionen besitzt wie eine Computer-Maus.
6		Energieanzeige ¹	Zeigt den Ein/Aus-Status des Computers an.
		Akku-Anzeige ¹	Zeigt den Akkustatus des Computers an. 1. Aufladung: Die Leuchte erscheint gelb, wenn der Akku aufgeladen wird. 2 Voll aufgeladen: Die Leuchte erscheint blau, wenn Netzstrom verwendet wird.
7		Anklicktasten (Links und Rechts)	Die linken und rechten Tasten funktionieren wie die linken und rechten Tasten einer Maus.
8		Handablage	Bequemer Ablagebereich für Ihre Hände während der Bedienung des Computers.
9		HDD	Leuchtet auf, wenn die Festplatte aktiv ist.
		Anzeige für Kommunikation	Zeigt den Drahtlos-Konnektivitätsstatus des Computers an.
10		Netzschalter	Schaltet den Computer ein und aus.
11		Mikrofon	Internes Mikrofon für die Tonaufnahme.

1. Die Statusanzeigen auf der Vorderseite sind selbst dann zu sehen, wenn die Computerklappe geschlossen ist.

Tastenkombinationen

Der Computer besitzt Direkttasten oder Tastenkombinationen für den Zugriff auf Computersteuerungen wie z. B. Bildschirmhelligkeit und Ausgangslautstärke.

Zum Aktivieren von Hotkeys müssen Sie zuerst die **<Fn>** Taste drücken und halten und dann die andere Taste der Tastenkombination drücken.

Tastenkombination	Symbol	Funktion	Beschreibung
<Fn> + <F3>		Kommunikation	Aktiviert/deaktiviert die Kommunikationseinrichtungen des Computers. (Kommunikationseinrichtungen können je nach Konfiguration abweichen.)
<Fn> + <F4>		Schlaf	Schaltet den Computer in den Schlaf-Modus.
<Fn> + <F5>		Display-Umschalter	Wechselt die Anzeigerausgabe zwischen Anzeigebildschirm, externem Monitor (falls angeschlossen) und gleichzeitig beiden Anzeigen.
<Fn> + <F6>		Display AUS	Schaltet die Hintergrundbeleuchtung des Bildschirms aus, um Energie zu sparen. Drücken Sie zum Einschalten eine beliebige Taste.
<Fn> + <F7>		Touchpad-Schalter	Schaltet das Touchpad ein oder aus.
<Fn> + <F8>		Lautsprecher-schalter	Schaltet die Lautsprecher ein und aus.
<Fn> + <Δ>		Lauter	Erhöht die Lautstärke.
<Fn> + <▽>		Leiser	Verringert die Lautstärke.
<Fn> + <▷>		Heller	Erhöht die Bildschirmhelligkeit.
<Fn> + <◁>		Dunkler	Verringert die Bildschirmhelligkeit.

Geschlossene Vorderseite



#	Symbol	Element	Beschreibung
1		Energieanzeige ¹	Zeigt den Ein/Aus-Status des Computers an.
		Akku-Anzeige ¹	<p>Zeigt den Akkustatus des Computers an.</p> <p>1. Aufladung: Die Leuchte erscheint gelb, wenn der Akku aufgeladen wird.</p> <p>2. Voll aufgeladen: Die Leuchte erscheint blau, wenn Netzstrom verwendet wird.</p>
2		Mehrere-in-1-Kartenleser	<p>Eignet sich für Secure Digital (SD), MultiMediaCard (MMC), Memory Stick (MS), Memory Stick PRO (MS PRO) und xD-Picture Card (xD).</p> <p>Hinweis: Drücken Sie hier, um die Karte zu entfernen/einzusetzen. Es kann nicht mehr als eine Karte gleichzeitig verwendet werden.</p>



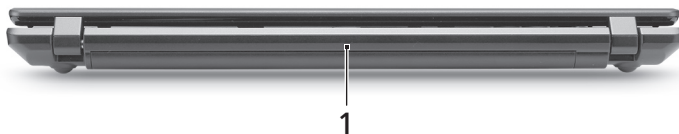



Rückseite

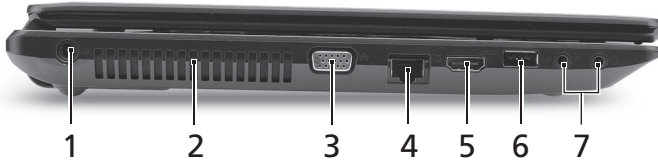

#	Symbol	Element	Beschreibung
1		Akku	Versorgt den Computer mit Strom, wenn er ohne Netzkabel betrieben wird.



Linke Seite



#	Symbol	Element	Beschreibung
1		DC-Eingangsbuchse	Hier schließen Sie das Netzteil an.
2		Belüftungsschlitze	Schützt den Computer vor Überhitzung, selbst bei längerem Einsatz.
3		Anschluss für externe Anzeige (VGA)	Dient dem Anschluss eines Anzeigegerätes (z.B. einem externen Monitor oder LCD-Projektor).
4		Ethernet (RJ-45)-Anschluss	Zum Anschluss eines Ethernet 10/100/1000-basierten Netzwerks.
5		HDMI-Anschluss	Unterstützt digitale High-Definition-Video-Verbindungen.
6		USB 2.0-Anschluss	Zum Anschluss von USB 2.0-Geräten (z.B. USB-Maus, USB-Kamera).
7		Mikrofon-Eingangs-Buchse	Eignet sich für Eingaben aus externen Mikrofonen.
		Kopfhörer-/Lautsprecher-/Ausgabe-Buchse	Zum Anschluss von Audioausgabegeräten (z.B. Lautsprecher, Kopfhörer).

Rechte Seite





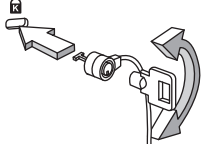

#	Symbol	Element	Beschreibung
1		USB 2.0-Anschluss	Zum Anschluss von USB 2.0-Geräten (z.B. USB-Maus, USB-Kamera).
2		Optisches Laufwerk	Internes optisches Laufwerk; eignet sich für CDs oder DVDs.
3		Optische Disk Anzeige	Leuchtet auf, wenn optisches Laufwerk aktiv ist.
4		Auswurf taste für optisches Laufwerk	Führt das optische Laufwerk heraus.
5		Mechanisches Auswurfloch	Schiebt den Träger des optischen Laufwerks aus, wenn der Computer ausgeschaltet ist. Hinweis: Stecken Sie eine Büroklammer in das Auswurfloch, um den Träger des optischen Laufwerkes herauszufahren, wenn der Computer nicht eingeschaltet ist.
6		Steckplatz für Kensington-Schloss	Hier können Sie ein Kensington-kompatibles Sicherheitsschloss für den Computer anbringen. Hinweis: Binden Sie ein Diebstahlsicherungskabel an ein unbewegliches Objekt wie einen Tisch oder einen Griff einer abgeschlossenen Schublade. Stecken Sie das Schloss in den Anschluss für die Diebstahlsicherung, und schließen Sie dieses ab. Es gibt auch Modelle ohne Schlüssel.

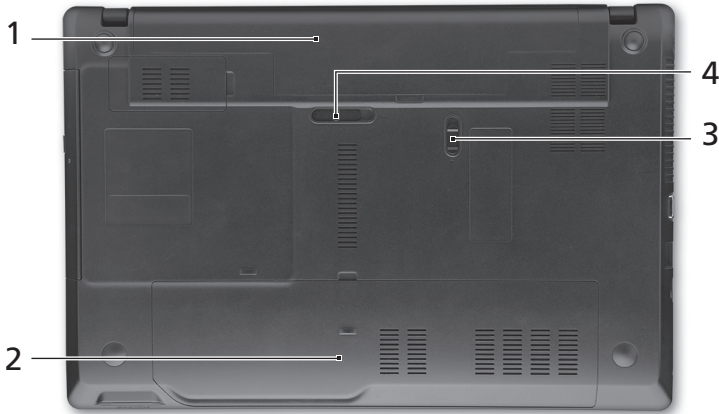

Unterseite



#	Symbol	Element	Beschreibung
1		Akkufach	Enthält den Akku des Computers.
2		Fach für Festplatte	Gehäuse der Computer-Festplatte (durch Schrauben gesichert).
		Speicherfach	Enthält den Hauptspeicher des Computers.
3		Akkuerschluss	Sichert den Akku an seiner Position.
4		Verriegelung des Akkus	Entsperrt den Akku für die Herausnahme.

Umgebung

- Temperatur:
 - Betrieb: 5°C bis 35°C
 - Nichtbetrieb: -20°C bis 65°C
- Luftfeuchtigkeit (nicht kondensierend):
 - Betrieb: 20% bis 80%
 - Nichtbetrieb: 20% bis 80%

Serie TravelMate 5740/ 5740Z/5340

Guida rapida

© 2010 Tutti i diritti riservati.

Guida rapida Serie TravelMate 5740/5740Z/5340

Prima edizione: 03/2010

PC Notebook Serie TravelMate 5740/5740Z/5340

Numero di modello: _____

Numero di serie: _____

Data di acquisto: _____

Luogo d'acquisto: _____

Avvertenze preliminari

Grazie per aver scelto il notebook Acer, la scelta ideale per poter lavorare in piena libertà anche in movimento.

Le guide disponibili

Sono state realizzate delle guide per assistere l'utente nell'uso del notebook Acer:

Innanzitutto, il **manifesto** aiuta a semplificare la configurazione del computer.

Il **Manuale dell'utente di TravelMate Series** contiene informazioni utili per tutti i modelli della serie TravelMate. Copre gli argomenti base come ad esempio Empowering Technology di Acer, l'uso della tastiera e dell'audio, ecc. A causa della sua natura, il **Manuale dell'utente** menzionato in precedenza a volte fa riferimento a funzioni o caratteristiche presenti solamente in alcuni modelli della serie, ma non necessariamente del modello acquistato. Per questo motivo alcuni elementi nel testo sono indicati con "solo per alcuni modelli".

Questa **Guida rapida** presenta le caratteristiche e le funzioni principali del nuovo computer. Per altre nozioni su come il vostro computer può aiutarvi a diventare ancora più produttivi, consultate la **AcerSystem User's Guide**. Questa guida contiene informazioni dettagliate su argomenti come utilità del sistema, ripristino dei dati, opzioni di espansione e ricerca guasti. Contiene inoltre informazioni sulla garanzia, le norme e gli standard di riferimento e le avvertenze per la sicurezza del vostro notebook. È disponibile nel formato PDF e viene fornita già caricata nel notebook. Per accedervi seguite questi passaggi:

- 1 Fare clic su **Start > Programmi > AcerSystem**.
- 2 Fare clic su **AcerSystem User's Guide**.



.....





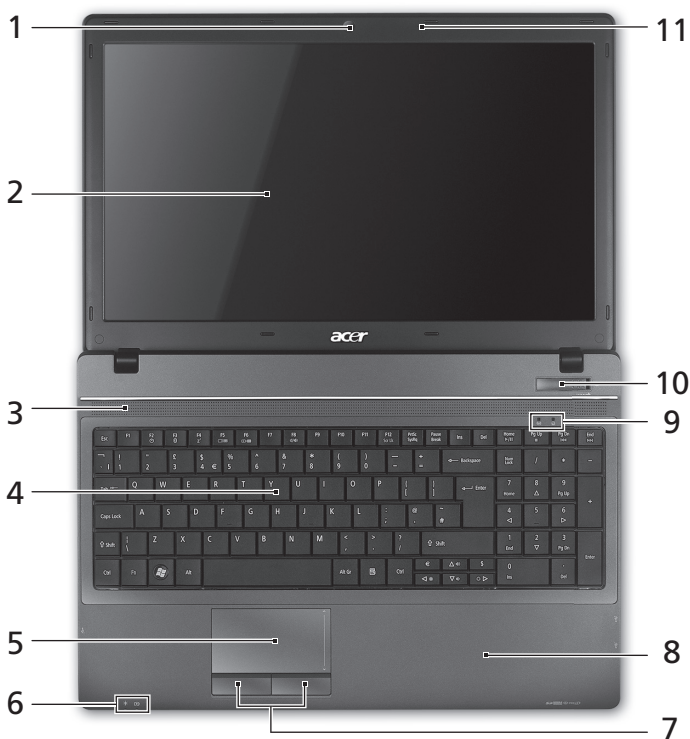

Nota: Per visualizzare il file, è necessario che sul computer sia installato Adobe Reader. Se Adobe Acrobat Reader non è installato sul computer, fare clic su **AcerSystem User's Guide** per eseguire il programma di installazione di Adobe Reader. Per completare l'installazione, attenersi alle istruzioni visualizzate sullo schermo. Per istruzioni sull'uso di Adobe Reader, consultare il menu **Guida in linea e supporto** tecnico .

Presentazione del notebook Acer

Dopo aver configurato il computer come illustrato nel manifesto
Per i principianti..., far riferimento alla presente documentazione per la
 presentazione del nuovo notebook Acer.

Vista dall'alto













#	Icona	Elemento	Descrizione
1		Webcam Acer Crystal Eye	Web camera per la comunicazione video (solo per alcuni modelli).
2		Display	Grande display a cristalli liquidi (Liquid-Crystal Display; LCD), per una visualizzazione confortevole (La configurazione può variare in relazione al modello).
3		Altoparlanti	Gli altoparlanti a sinistra e a destra forniscono l'uscita audio stereo.
4		Tastiera	Per l'immissione di dati sul computer.
5		Touchpad	Dispositivo di puntamento sensibile al tocco con funzioni simili a quelle di un comune mouse.
6		Indicatore di alimentazione ¹	Indicano lo stato di accensione/alimentazione del computer.
		Indicatore batteria ¹	Indicano lo stato della batteria del computer. 1. In carica: Luce di colore giallo quando la batteria è in ricarica. 2. Completamente carica: Luce di colore blu quando è nella modalità AC.
7		Tasti clic (sinistra e destra)	I tasti destra e sinistra hanno le stesse funzioni dei tasti destra e sinistra del mouse.
8		Poggiapolsi	Comoda area su cui poggiare i polsi durante l'utilizzo del computer.
9		HDD	Si accende quando l'hard disk è attivo.
		Indicatore comunicazione	Indica lo stato della connettività wireless del computer.
10		Interruttore alimentazione	Accende/spegne il computer.
11		Microfono	Microfono interno per la registrazione di audio.

1. Gli indicatori del pannello frontale sono visibili anche quando il coperchio del computer è chiuso.

Tasti di scelta rapida



Il computer utilizza i tasti di scelta o le combinazioni di tasti per l'accesso a molti controlli del computer come luminosità dello schermo e uscita volume.

Per attivare i tasti di scelta rapida, tenere premuto **<Fn>** e premere l'altro tasto della combinazione.

Tasti di scelta rapida	Icona	Funzione	Descrizione
<Fn> + <F3>		Comunicazioni	Attiva/disattiva i dispositivi di comunicazione del computer. (i dispositivi di comunicazione possono variare in relazione alla configurazione.)
<Fn> + <F4>		Sospensione	Attiva la modalità sospensione del computer.
<Fn> + <F5>		Passaggio da uno schermo all'altro	Consente la commutazione in uscita display tra video del display o monitor esterno (se collegato) e entrambi.
<Fn> + <F6>		Disattiva display	Disattiva la retroilluminazione dello schermo per risparmiare energia. Premere un tasto qualsiasi per tornare allo stato precedente.
<Fn> + <F7>		Attivazione e disattivazione del touchpad	Attiva e disattiva il touchpad.
<Fn> + <F8>		Attivazione e disattivazione degli altoparlanti	Attiva e disattiva gli altoparlanti.
<Fn> + <Δ>		Aumento del volume	Aumenta il volume.
<Fn> + <▽>		Riduzione del volume	Riduce il volume.
<Fn> + <D>		Aumento della luminosità	Consente di aumentare la luminosità dello schermo.
<Fn> + <L>		Riduzione della luminosità	Riduce la luminosità dello schermo.

Vista frontale in dettaglio



#	Icona	Elemento	Descrizione
1		Indicatore di alimentazione ¹	Indicano lo stato di accensione/alimentazione del computer.
		Indicatore batteria ¹	Indicano lo stato della batteria del computer. 1. In carica: Luce di colore giallo quando la batteria è in ricarica. 2. Completamente carica: Luce di colore blu quando è nella modalità AC.
2		Lettoře di schede multiplo	Supporta Secure Digital (SD), MultiMediaCard (MMC), Memory Stick (MS), Memory Stick Pro (MS PRO), e xD-Picture Card (xD). Nota: Premere per rimuovere/installare la scheda. È possibile utilizzare una sola scheda di memoria alla volta.

Vista posteriore

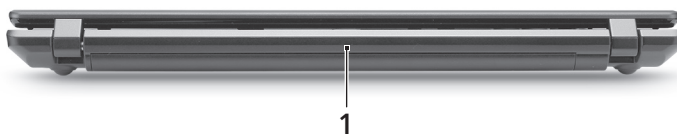

#	Icona	Elemento	Descrizione
1		Batteria	Fornisce alimentazione al computer quando viene utilizzato senza corrente elettrica.

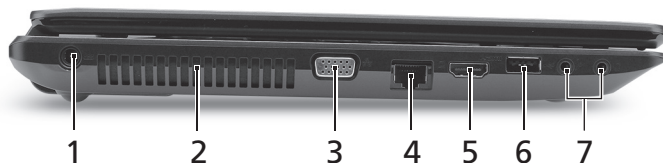

Vista da sinistra



#	Icona	Elemento	Descrizione
1		Jack CC-in	Per il collegamento all'adattatore CA.
2		Aperture per la ventilazione	Permettono il raffreddamento del computer, anche dopo un uso prolungato.
3		Porta display esterno (VGA)	Effettua il collegamento a un dispositivo di visualizzazione (ad es., monitor esterno, proiettore LCD).
4		Porta Ethernet (RJ-45)	Effettua il collegamento a una rete con Ethernet 10/100/1000.
5	HDMI	Porta HDMI	Supporta collegamento per video digitali ad alta definizione.
6		Porta USB 2.0	Effettua il collegamento ai dispositivi USB 2.0 (ad es., mouse USB, fotocamera USB).
7		Jack ingresso microfono	Accetta ingressi provenienti da microfoni esterni.
		Jack auricolari/altoparlante/line-out	Effettua il collegamento ai dispositivi audio line-out (ad es., altoparlanti, auricolari).

Vista da destra





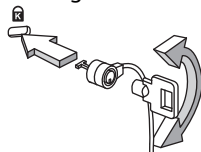

#	Icona	Elemento	Descrizione
1		Porta USB 2.0	Effettua il collegamento ai dispositivi USB 2.0 (ad es., mouse USB, fotocamera USB).
2		Lettoce ottico	Unità ottica interna, accetta CD o DVD.
3		Indicatore accesso disco ottico	Si accende quando il disco ottico è attivo.
4		Tasto di espulsione del disco ottico	Espelle il disco ottico dall'unità.
5		Foro di espulsione di emergenza	Espelle il vassoio del disco ottico se il computer è spento. Nota: Inserire la punta di un fermaglio nel foro di apertura di emergenza per espellere il vassoio dell'unità ottica quando il computer è spento.
6		Slot blocco Kensington	Per il collegamento al blocco di sicurezza dei computer Kensington-compatibili. Nota: Avvolgere un cavo di sicurezza per computer intorno ad un oggetto fisso, ad esempio un tavolo o la maniglia di un cassetto chiuso a chiave. Inserire la serratura nel foro e girare la chiave per fissare il blocco. Sono disponibili anche modelli senza chiave.

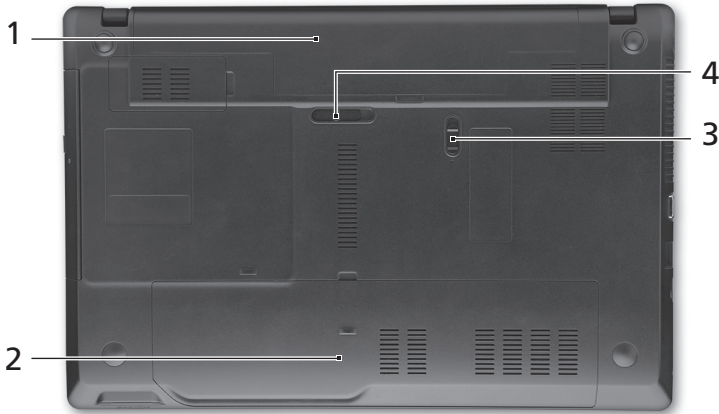

Vista base



#	Icona	Elemento	Descrizione
1		Alloggiamento della batteria	Contiene il pacco batteria del computer.
2		Alloggiamento per il disco rigido	Alloggia il disco rigido del computer (fissato con viti).
		Vano per la memoria	Contiene la memoria principale del computer.
3		Blocco batteria	Blocca la batteria al suo posto.
4		Gancio di rilascio della batteria	Per togliere la batteria.

Condizioni operative

- Temperatura:
 - Di esercizio: da 5°C a 35°C
 - Non di esercizio: da -20°C a 65°C
- Umidità (senza condensa):
 - Di esercizio: da 20% a 80%
 - Non di esercizio: da 20% a 80%

Serie TravelMate 5740/5740Z/ 5340

Guía rápida

© 2010 Reservados todos los derechos.

Guía rápida de la Serie TravelMate 5740/5740Z/5340
Versión original: 03/2010

Ordenador portátil Serie TravelMate 5740/5740Z/5340

Número de modelo: _____

Número de serie: _____

Fecha de compra: _____

Lugar de compra: _____

Primero lo más importante

Le agradecemos que haya elegido el ordenador portátil de Acer para satisfacer sus necesidades de informática móvil.

Sus guías

Para ayudarle a utilizar el ordenador portátil Acer, hemos elaborado un conjunto de guías:

En primer lugar, el **póster de configuración** contiene información de ayuda para configurar su ordenador.

La **Guía de usuario genérica de la serie TravelMate** en formato impreso contiene información útil aplicable a todos los modelos de productos de la serie TravelMate. Contempla aspectos básicos como el uso del teclado, el audio, etc. No obstante, no se olvide que debido a su carácter, la **Guía del usuario de AcerSystem** mencionada a continuación se referirá ocasionalmente a las funciones o características incluidas sólo en ciertos modelos de la serie, pero no necesariamente al modelo que haya adquirido usted. Dichos ejemplos se marcan en el texto del idioma como por ejemplo "sólo en determinados modelos".

La **Guía rápida** presenta las características y funciones básicas de su nuevo ordenador. Si desea más información sobre cómo puede su ordenador ayudarle a ser más productivo, consulte la **Guía del usuario de AcerSystem**. Esa guía contiene información detallada sobre temas como utilidades del sistema, recuperación de datos, opciones de expansión y resolución de problemas. Además, contiene información sobre garantías y las normativas generales y advertencias de seguridad para su ordenador portátil. Está disponible en PDF (Formato de Documento Portátil) y viene precargada en su ordenador portátil. Siga estos pasos para acceder al manual:

- 1 Haga clic en **Inicio > Todos los programas > AcerSystem**.
- 2 Haga clic en **Guía del usuario de AcerSystem**.



.....





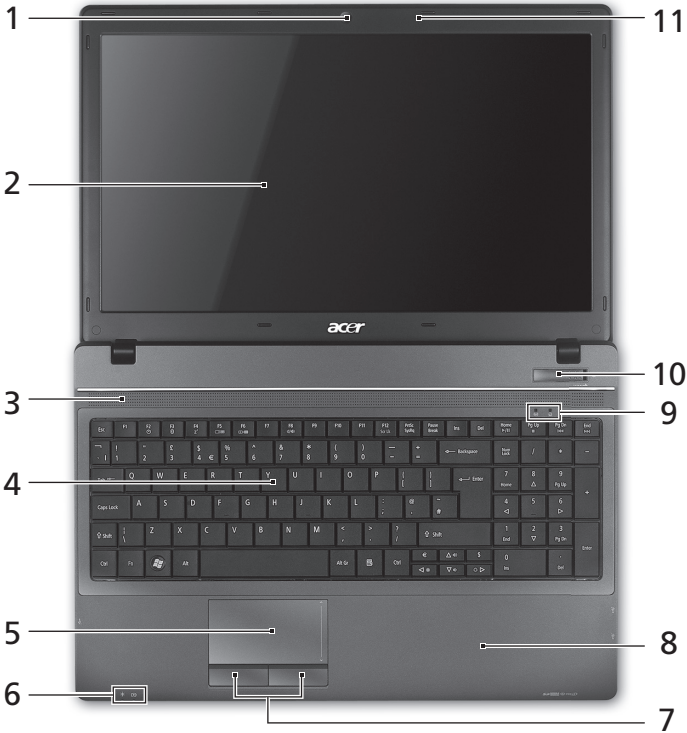

Nota: Para poder ver el archivo, debe tener instalado Adobe Reader. Si no lo tiene instalado, haga clic en **AcerSystem User Guide** para que se ejecute el programa de instalación de Adobe Reader. Siga las instrucciones en pantalla para completar la instalación. Para obtener información sobre cómo utilizar Adobe Reader, acceda al menú **Ayuda y soporte técnico**.

Un paseo por el ordenador portátil Acer

Una vez configurado el ordenador del modo indicado en el póster **Para principiantes...**, permítanos enseñarle su nuevo ordenador portátil de Acer.

Vista superior













#	Icono	Elemento	Descripción
1		Webcam Acer Crystal Eye	Cámara Web para comunicación de vídeo (sólo en determinados modelos).
2		Visualización en pantalla	También denominada pantalla de cristal líquido (LCD) es el dispositivo de salida visual del ordenador. (La configuración puede variar según el modelo.)
3		Altavoces	Los altavoces frontal izquierdo y frontal derecho proporcionan una salida de audio estéreo.
4		Teclado	Para introducir datos en su ordenador.
5		Almohadilla de toque	Dispositivo apuntador táctil que funciona como un ratón de ordenador.
6		Indicador de encendido ¹	Proporciona información sobre el estado de energía del ordenador.
		Indicador de batería ¹	Proporciona información sobre el estado de la batería. 1. Carga: La luz se vuelve ámbar cuando se carga la batería. 2. Carga completa: La luz se vuelve azul en modo de CA.
7		Botones de hacer clic (izquierdo y derecho)	Los botones izquierdo y derecho funcionan como los botones izquierdo y derecho del ratón.
8		Soporte para las palmas	Área de soporte que permite reposar cómodamente las palmas de las manos cuando se utiliza el ordenador.
9		HDD (disco duro)	Indica si la unidad de disco duro está activa.
		Indicador de comunicación	Proporciona información sobre el estado del dispositivo de conectividad inalámbrica del ordenador.
10		Interruptor de encendido	Enciende o apaga el ordenador.
11		Micrófono	Micrófono interno para la grabación del sonido.

1. Los indicadores del panel frontal son visibles aunque se cierre la tapa del ordenador.

Teclas de acceso directo



El ordenador utiliza teclas de acceso directo o combinaciones de teclas para acceder a la mayoría de controles del ordenador como el brillo de la pantalla o la salida de volumen.

Para activar las teclas de acceso directo, mantenga pulsada la tecla **<Fn>** y pulse la siguiente tecla de la combinación.

Tecla de acceso directo	Icono	Función	Descripción
<Fn> + <F3>		Comunicación	Activa/desactiva los dispositivos de comunicación del ordenador. (Los dispositivos de comunicación pueden variar según la configuración.)
<Fn> + <F4>		Suspensión	Pone el ordenador en modo de suspensión.
<Fn> + <F5>		Selector de pantalla	Cambia la salida entre la pantalla y el monitor externo (si está conectado) o ambos.
<Fn> + <F6>		Apagado de pantalla	Apaga la luz de fondo de la pantalla para ahorrar energía. Pulse cualquier tecla para encenderla.
<Fn> + <F7>		Panel táctil	Enciende y apaga el panel táctil.
<Fn> + <F8>		Alternar altavoces	Activa o desactiva los altavoces.
<Fn> + <▲>		Subir volumen	Sube el volumen.
<Fn> + <▼>		Bajar volumen	Baja el volumen.
<Fn> + <◀>		Aumentar brillo	Aumenta el brillo de la pantalla.
<Fn> + <▶>		Disminuir brillo	Disminuye el brillo de la pantalla.

Vista frontal cerrada



#	Icono	Elemento	Descripción
1		Indicador de encendido ¹	Proporciona información sobre el estado de energía del ordenador.
		Indicador de batería ¹	Proporciona información sobre el estado de la batería. 1. Carga: La luz se vuelve ámbar cuando se carga la batería. 2. Carga completa: La luz se vuelve azul en modo de CA.
2		Lector de tarjetas multifunción	Admite la tarjeta Secure Digital (SD), MultiMedia (MMC), Memory Stick (MS), Memory Stick PRO (MS PRO), xD-Picture (xD). Nota: Presionar para extraer/installar la tarjeta. Sólo puede funcionar una tarjeta en un momento dado.

Vista trasera



#	Icono	Elemento	Descripción
1		Batería	Proporciona alimentación para que el ordenador se utilice mientras esté desconectado.

Vista izquierda

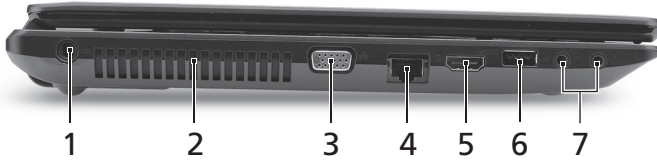

#	Icono	Elemento	Descripción
1		Conector de entrada de DC	Permite conectar a un adaptador de CA.
2		Ranuras de ventilación	Permite que el ordenador esté frío, incluso tras un uso prolongado.
3		Puerto de visualización externo (VGA)	Permite conectar a un dispositivo de visualización (p.ej., monitor externo, proyector de LCD).
4		Puerto Ethernet (RJ-45)	Permite conectar a una red basada en Ethernet 10/100/1000.
5		Puerto HDMI	Compatible con conexiones de vídeo digital de alta definición.
6		Puerto USB 2.0	Conexión para dispositivos USB 2.0 (p.ej., ratón USB, cámara USB).
7		Conector de entrada para micrófono	Permite la entrada de audio de micrófonos externos.
		Auriculares/altavoz/conector de línea de salida	Conexión para dispositivos de salida de audio (p.ej., altavoces, auriculares).





Vista derecha

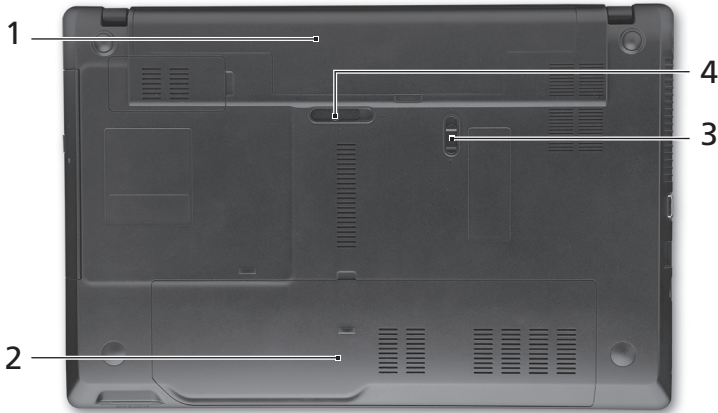

#	Icono	Elemento	Descripción
1		Puerto USB 2.0	Conexión para dispositivos USB 2.0 (p.ej., ratón USB, cámara USB).
2		Unidad óptica	Dispositivo óptico interno; acepta CDs y DVDs.
3		Indicador de acceso del disco óptico	Se enciende cuando la unidad óptica está activa.
4		Botón de expulsión de la unidad óptica	Expulsa el disco óptico de la unidad.
5		Orificio de expulsión de emergencia	Expulsa la bandeja de la unidad óptica cuando el ordenador está apagado. Nota: Introduzca un clip sujetapapeles en el orificio de expulsión para expulsar la bandeja de la unidad óptica cuando el ordenador esté apagado.
6		Ranura de bloqueo Kensington	Permite conectar a un candado de seguridad para ordenador compatible con Kensington. Nota: Coloque un cable de seguridad para ordenadores alrededor de un objeto fijo como una mesa o el tirador de un cajón cerrado con llave. Introduzca el candado en la ranura y gire la llave. También hay modelos sin llave.

Vista de la base



#	Icono	Elemento	Descripción
1		Compartimiento de la batería	Aloja la batería del ordenador.
2		Compartimiento del disco duro	Contiene el disco duro del ordenador (fijado con tornillos).
		Compartimiento de memoria	Contiene la memoria principal de ordenador.
3		Bloqueo de la batería	Permite que la batería quede trabada.
4		Pestillo de liberación de la batería	Libera la batería para poder sacarla.

Entorno

- Temperatura:
 - Funcionamiento: 5°C a 35°C
 - Sin operación: -20°C a 65°C
- Humedad (sin condensación):
 - Funcionamiento: 20% a 80%
 - Sin operación: 20% a 80%

Notificacion Regulatoria Adicional

[Argentina]

El portatil Acer viene con los modulos de telecomunicaciones aprobados ya incorporados para su conexion a la red. El numero de modelo y numero de homologacion especifico para estos modelos se refieren a continuacion.

[Modem]

Modelo: RD02-D330	CNC 54-4512
Modelo: Delphi_D40	CNC 53-4581
Modelo: Delphi_D40 (AM5)	CNC 54-5681

[Bluetooth]

Modelo: BCM92045NMD	CNC 16-4062
---------------------	-------------

[802.11AGN]

Modelo: 4965AGN	CNC C-5421
Modelo: BCM94321MC	CNC C-5225
Modelo: 512AN_MMW	CNC C-6399
Modelo: 533AN_MMW	CNC C-6385

[802.11ABG]

Modelo: 4965AG_	CNC C-5424
Modelo: WM3945ABG	CNC C-4531
Modelo: AR5BXB6	CNC C-4340





[802.11BG]

Modelo: BCM94311MCG	CNC C-4250
Modelo: AR5BXB63	CNC C-5448
Modelo: BCM94312MCG	CNC C-5871



[Brasil] Noticia adicional de regulamento Anatel

Os componentes de telecomunicacao usados nos notebooks Acer em Portugues sao homologados atendendo a requisicao da Agencia Nacional de Telecomunicacoes Anatel, conforme referencia abaixo:

[Modem]

Modelo: RD02-D330	 1406-05-1675	
Modelo: Delphi_D40	 0455-06-2565	 (01) 0789 834989 0382



[Bluetooth]

Modelo: BCM92045NMD	 0578-05-1869	 0107898349891648
------------------------	--	---

[802.11AGN]

Modelo: 4965AGN	 ANATEL 0578-07-2198	 (01)0789 8355950322
Modelo: BCM94321MC	 ANATEL 1761-06-1869	 010789834991345
Modelo: 512AN_MMW	 ANATEL 0807-08-2198	 (01) 07898355950018
Modelo: 512AN_HMW	 ANATEL 0800-08-2198	 (01) 07898355950025
Modelo: 533AN_MMW	 ANATEL 0809-08-2198	 (01) 07898355950032
Modelo: 533AN_HMW	 ANATEL 0812-08-2198	 (01) 07898355950049





[802.11BGN]

Modelo: AR5B91	 ANATEL 1182-08-3987	 7898915959 50 5
-------------------	--	--

[802.11ABG]

Modelo: 4965AG_	 ANATEL 0350-07-2198	 (01)07898355950339
Modelo: WM3945ABG	 ANATEL 0151-06-2198	 0107898355950063
Modelo: AR5XB6	 ANATEL 1188-05-2634	 0107898914152020

[802.11BG]

Modelo: BCM94311MCG	 ANATEL 0979-05-1869	 0107898349891747
Modelo: AR5XB63	 ANATEL 1188-05-2634	 0107898915959123
Modelo: BCM94312MCG	 ANATEL 1558-07-1869	 (01)07898349892140

Série TravelMate 5740/ 5740Z/5340

Guia rápido

© 2010 Todos os Direitos Reservados.

Guia rápido da Série TravelMate 5740/5740Z/5340

Edição Original: 03/2010

Computador Portátil Série TravelMate 5740/5740Z/5340

Número de Modelo: _____

Número de Série: _____

Data de Compra: _____

Local de Aquisição: _____

Primeiro que tudo

Gostaríamos de lhe agradecer por ter escolhido um computador portátil Acer para preencher as suas necessidades de computador móvel.

Os seus manuais

Para o ajudar a usar o seu computador portátil Acer, preparámos uma série de manuais:

Antes de mais, o **cartaz de configuração** ajuda-o a iniciar e a configurar o seu computador.

O **Manual Genérico do utilizador da Série TravelMate** contém informações úteis que se aplicam a todos os modelos da série de produtos TravelMate. Abrange tópicos básicos como a utilização do teclado, áudio, etc. Pedimos a sua compreensão para o facto de, pela sua natureza, o **Manual do Utilizador do AcerSystem** abaixo mencionados referem-se ocasionalmente a funções ou funcionalidades apenas aplicáveis a determinados modelos da série, mas não necessariamente ao modelo específico que adquiriu. Tais situações estão assinaladas no texto com expressões como "apenas em certos modelos".

Este **Guia rápido** apresenta as características e funções básicas do seu novo computador. Para mais detalhes sobre como o seu computador o pode ajudar a ser mais produtivo, consulte o **AcerSystem User Guide**. Esse manual contém informações pormenorizadas sobre temas como utilitários do sistema, recuperação de dados, opções de expansão e solução de problemas. Além disso, contém a informação da garantia e as regulamentações gerais e notas de segurança para o seu computador portátil. Está disponível no formato PDF (Portable Document Format) e vem já instalado no seu computador. Siga estes passos para o aceder:

- 1 Clique em **Iniciar > Todos os programas > AcerSystem**.
- 2 Clique em **AcerSystem User Guide**.



.....





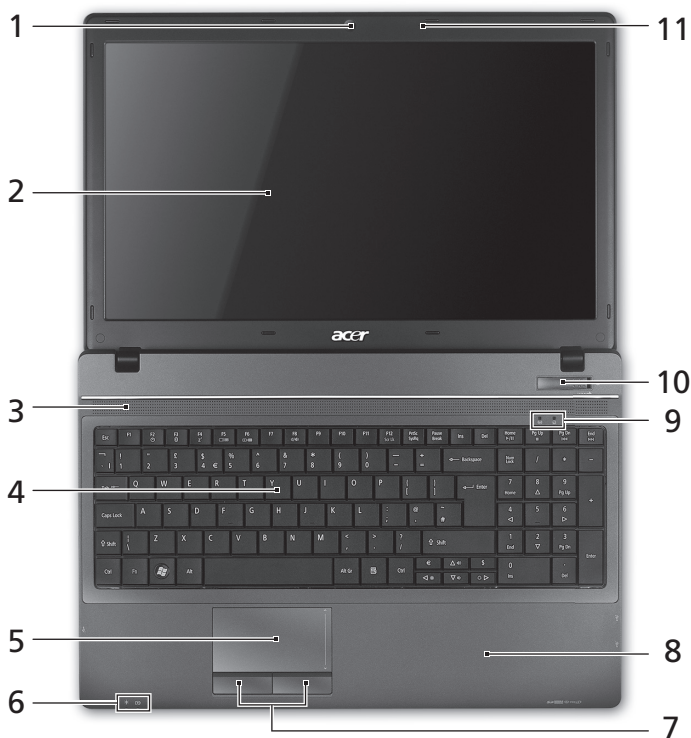

Nota: é necessário instalar o Adobe Reader para visualizar o ficheiro. Se o Adobe Reader não estiver instalado no seu computador, ao clicar em **AcerSystem User Guide** (Manual do Utilizador AcerSystem) é executado o programa de instalação do Acrobat Reader. Siga as instruções do ecrã para finalizar a instalação. Para obter instruções sobre como utilizar o Adobe Reader, vá ao menu **Ajuda e Suporte**

Visita guiada ao seu computador portátil Acer

Após montar o computador tal como indicado na ilustração do cartaz **Para começar...**, deixe-nos dar-lhe a conhecer o seu novo portátil Acer.

Vista de cima



#	Ícone	Item	Descrição
1		Webcam Acer Crystal Eye	Webcam para comunicação por vídeo (apenas em certos modelos).
2		Ecrã	Também chamado ecrã de cristais líquidos (LCD), permite visualizar a informação do computador (A configuração pode variar consoante o modelo).
3		Altifalantes	Os altifalantes frontal esquerdo e frontal direito permitem saída de áudio estéreo.
4		Teclado	Para introduzir informações no seu computador.
5		Teclado táctil	Dispositivo apontador sensível ao toque, que funciona como um rato de computador.
6		Indicador de alimentação ¹	Indica o estado da alimentação do computador.
		Indicador de bateria ¹	Indica o estado da bateria do computador. 1. A carregar: A luz é âmbar quando a bateria está a carregar. 2. Carga completa: A luz é azul no modo CA.
7		Botões para clicar (esquerdo e direito)	Os botões esquerdo e direito funcionam como os botões esquerdo e direito de um rato.
8		Descanso de mãos	Área confortável de apoio para as suas mãos enquanto utiliza o computador.
9		HDD (disco rígido)	Indica quando o disco rígido está activo.
		Indicador de comunicação	Indica o estado do dispositivo de ligação sem fios do computador.
10		Interruptor de energia	Liga e desliga o computador.
11		Microfone	Microfone interno para gravação de som.

1. Os indicadores no painel dianteiro são visíveis mesmo com a tampa do monitor fechada.

Teclas de atalho

O computador utiliza teclas de atalho ou combinações de teclas para aceder à maior parte dos seus comandos, tais como a luminosidade do ecrã e o volume de saída.

Para activar as teclas de atalho, prima e mantenha premida a tecla <Fn> antes de premir a outra tecla na combinação de teclas de atalho.

Tecla de atalho	Ícone	Função	Descrição
<Fn> + <F3>		Comunicação	Activa/desactiva os dispositivos de comunicação do computador. (Os dispositivos de comunicação podem variar consoante a configuração.)
<Fn> + <F4>		Suspensão	Coloca o computador no modo de Suspensão.
<Fn> + <F5>		Comutação de visualização	Alterna a saída entre o ecrã de visualização, o monitor externo (se está ligado) e ambos.
<Fn> + <F6>		Ecrã desligado	Desliga a luz de fundo do ecrã de visualização para economizar energia. Prima qualquer tecla para retomar a actividade.
<Fn> + <F7>		Comutação de touchpad (teclado táctil)	Liga e desliga o teclado táctil..
<Fn> + <F8>		Comutação de altifalante	Liga e desliga os altifalantes.
<Fn> + <Δ>		Aumentar volume	Aumenta o volume de som.
<Fn> + <▽>		Diminuir volume	Diminui o volume de som.
<Fn> + <▷>		Aumentar luminosidade	Aumenta a luminosidade do ecrã.
<Fn> + <◁>		Reduzir luminosidade	Reduz a luminosidade do ecrã.

Vista frontal, fechado



#	Ícone	Item	Descrição
1		Indicador de alimentação ¹	Indica o estado da alimentação do computador.
		Indicador de bateria ¹	Indica o estado da bateria do computador. 1. A carregar: A luz é âmbar quando a bateria está a carregar. 2. Carga completa: A luz é azul no modo CA.
2		Leitor de cartões vários-em-um	Aceita cartões Secure Digital (SD), MultiMediaCard (MMC), Memory Stick (MS), Memory Stick PRO (MS PRO), xD-Picture Card (xD). Nota: Empurre para remover/instalar o cartão. Apenas pode ser utilizado um cartão de cada vez.

Visão traseira



#	Ícone	Item	Descrição
1		Bateria	Fornece energia ao computador para utilização quando desligado da corrente.

Vista esquerda

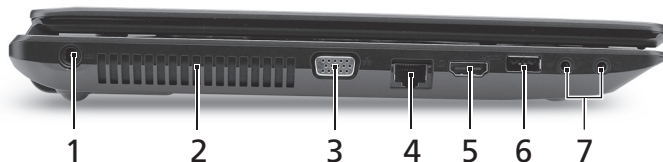

#	Ícone	Item	Descrição
1		Tomada de entrada CC	Liga a um adaptador CA.
2		Ranhas de ventilação	Permite ao computador manter-se fresco, mesmo após uso prolongado.
3		Ligação a ecrã externo (VGA)	Liga a um dispositivo de visualização (por exemplo, monitor externo, projector LCD).
4		Entrada Ethernet (RJ-45)	Liga a uma rede Ethernet de base 10/100/1000.
5		Porta HDMI	Suporta ligações de vídeo digital de alta definição.
6		Entrada USB 2.0	Liga a dispositivos USB 2.0 (por ex. rato USB, câmara USB).
7		Conector de entrada do microfone	Aceita entradas de microfones externos.
		Tomada de auscultadores/altifalante/saída	Liga a dispositivos de saída de áudio (por exemplo, altifalantes, auscultadores).

Vista direita





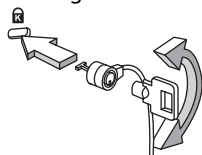

#	Ícone	Item	Descrição
1		Entrada USB 2.0	Liga a dispositivos USB 2.0 (por ex. rato USB, câmara USB).
2		Unidade óptica	Unidade óptica interna; aceita CD ou DVD.
3		Indicador de acesso do disco óptico	Acende quando a unidade óptica está activa.
4		Botão de ejeção da unidade óptica	Ejecta o disco óptico da unidade.
5		Furo de ejeção de emergência	Ejecta o tabuleiro da unidade óptica quando o computador está desligado. Nota: Introduza um clipe no orifício de ejeção de emergência, para a unidade óptica ejectar o tabuleiro quando desligado o computador.
6		Ranhura para fecho Kensington	Liga a um cadeado de segurança Kensington (ou compatível). Nota: Enrole o cabo de bloqueio de segurança do computador em torno de um objecto imóvel, como por exemplo uma mesa ou o puxador de uma gaveta fechada. Introduza o cabo de segurança na ranhura e rode a chave para proteger o bloqueio. Também estão disponíveis modelos sem chave.

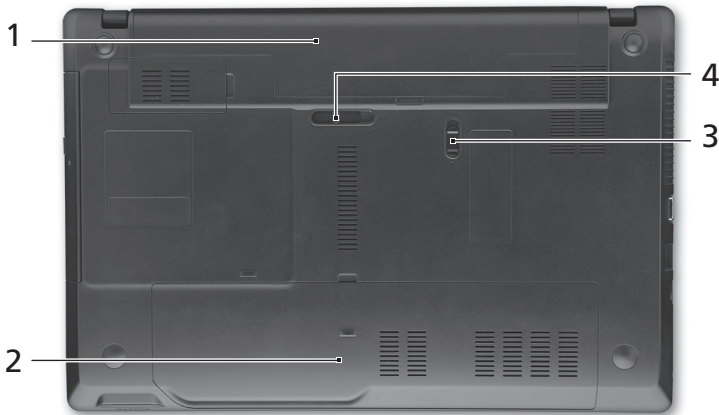

Visão da base



#	Ícone	Item	Descrição
1		Baía da bateria	Contém a bateria do computador.
2		Compartimento do disco rígido	Aloja o disco rígido do computador (seguro por parafusos).
		Compartimento da memória	Aloja a memória principal do computador.
3		Bloqueio da bateria	Bloqueia a bateria, mantendo-a no sítio.
4		Patilha de libertação da bateria	Liberta a bateria para remoção.

Ambiente

- Temperatura:
 - Funcionamento: 5°C a 35°C
 - Não em funcionamento: -20°C a 65°C
- Humidade (não condensação):
 - Funcionamento: 20% a 80%
 - Não em funcionamento: 20% a 80%

TravelMate 5740/5740Z/5340 Serie

Snelgids

© 2010 Alle rechten voorbehouden.

Snelgids voor de TravelMate 5740/5740Z/5340 Serie
Oorspronkelijke uitgave: 03/2010

TravelMate 5740/5740Z/5340 Serie Notebook PC

Modelnummer: _____

Serienummer: _____

Aankoopdatum: _____

Plaats van aankoop: _____

Om te beginnen

Bedankt dat u hebt gekozen voor een notebook van Acer als oplossing voor uw mobiele computereisen.

Uw gidsen

Om u te helpen met het werken op het Acer notebook hebben we een aantal gidsen ontworpen:

Allereerst helpt de **instelkaart** u bij het instellen van uw computer.

De gedrukte **Algemene gebruikershandleiding van de TravelMate Serie** bevat handige informatie die van toepassing zijn op alle modellen uit de TravelMate productreeks. De handleiding behandelt basale onderwerpen, zoals het gebruik van het toetsenbord, geluid, enz. De hieronder genoemde **AcerSystem gebruikershandleiding** verwijst af en toe naar functies of kenmerken die slechts voor enkele modellen in de reeks gelden, en dus niet noodzakelijk voor het model dat u heeft aangeschaft. Dit wordt in de tekst aangegeven met opmerkingen in de trand van "alleen voor bepaalde modellen".

In de **Snelgids** krijgt u een introductie over de basiseigenschappen en functies van de nieuwe computer. Als u meer wilt weten over hoe de computer u kan helpen productiever te werken, raadpleeg dan de **AcerSystem Gebruikershandleiding**. Deze Gebruikershandleiding bevat gedetailleerde informatie over onderwerpen zoals systeemfuncties, gegevensherstel, uitbreidingsopties en probleem oplossen. Daarnaast bevat het informatie over garantie en de algemene voorwaarden en veiligheid voor uw notebook. Het is als Portable Document Format (PDF) beschikbaar en is al van te voren op uw notebook gezet. Volg deze stappen voor toegang tot dit document:

- 1 Klik op **Start > Alle programma's > AcerSystem**.
- 2 Klik vervolgens op **AcerSystem Gebruikershandleiding**.









Opmerking: Als u het bestand wilt inzien, dient Adobe Reader te zijn geïnstalleerd. Als Adobe Reader nog niet op uw computer is geïnstalleerd, wordt, als u op **AcerSystem Gebruikershandleiding** klikt, eerst het installatieprogramma van Adobe Reader gestart. Volg de instructies op het scherm om het programma te installeren. Gebruiksaanwijzingen bij Adobe Reader vindt u in het menu **Help en Ondersteuning**.

Rondleiding door uw Acer notebook

Nadat u de computer hebt ingesteld zoals is beschreven op de poster **Aan de slag...**, bent u nu klaar voor een rondleiding door het nieuwe Acer notebook.

Bovenkant













#	Pictogram	Item	Beschrijving
1		Acer Crystal Eye webcam	Webcam voor videocommunicatie (alleen voor bepaalde modellen).
2		Beeldscherm	Ook wel Liquid-Crystal Display (LCD) genoemd, geeft de output van de computer weer (Configuratie kan per model verschillen).
3		Luidsprekers	De luidsprekers linksvoor en rechtsvoor zorgen voor stereogeluid.
4		Toetsenbord	Om gegevens in te voeren in de computer.
5		Touchpad	Tastgevoelig aanwijsapparaat dat functioneert als een computermuis.
6		Stroomindicator ¹	Geeft de vermogenstatus van de computer aan.
		Accu-indicator ¹	Geeft de batterijstatus van de computer aan. 1. Opladen: Het licht is oranje wanneer de accu wordt opgeladen. 2. Volledig opgeladen: Het licht is blauw in de AC-modus.
7		Kliktoetsen (links en rechts)	De toetsen links en rechts functioneren als de linker en rechter muistoetsen.
8		Polssteun	Comfortabele ondersteuning voor uw handen wanneer u de computer gebruikt.
9		HDD	Licht op wanneer de harde schijf actief is.
		Communicatie-indicator	Geeft de apparaatstatus van de draadloze verbindingen van de computer aan.
10		Aan/uit-toets	Schakelt de computer aan en uit.
11		Microfoon	Interne microfoon voor geluidsopname.

1. De statusindicatoren aan de voorkant zijn zelfs zichtbaar als het scherm gesloten is.

Sneltoetsen



De computer gebruikt sneltoetsen of toetscombinaties voor toegang tot de meeste besturingselementen, zoals helderheid en geluidsvolume.

Om een sneltoets te gebruiken drukt u de **<Fn>** -toets in voordat u de andere toets van de combinatie indrukt.

Sneltoets	Pictogram	Functie	Beschrijving
<Fn> + <F3>		Communicatie	Schakelt de communicatieapparaten van de computer in/uit. (Communicatieapparaten kunnen verschillen per configuratie.)
<Fn> + <F4>		Standby	Hiermee plaatst u de computer in de Standby-stand.
<Fn> + <F5>		Schakeltoets voor beeldscherm	Schakelt de weergave-uitvoer tussen het scherm, externe monitor (indien aangesloten) en beide.
<Fn> + <F6>		Beeldscherm uit	Hiermee schakelt u de lamp van het beeldscherm uit om stroom te besparen. Druk op een willekeurige toets om het beeldscherm weer te activeren.
<Fn> + <F7>		Schakeltoets voor touchpad	Schakelt het touchpad in en uit.
<Fn> + <F8>		Schakeltoets voor luidspreker	Hiermee schakelt u de luidsprekers in en uit.
<Fn> + <Δ>		Volume omhoog	Hiermee verhoogt u het luidsprekervolume.
<Fn> + <▽>		Volume omlaag	Hiermee verlaagt u het luidsprekervolume.
<Fn> + <▷>		Helderheid verhogen	Hiermee verhoogt u de helderheid van het beeldscherm.
<Fn> + <◁>		Helderheid verlagen	Hiermee verlaagt u de helderheid van het beeldscherm.

Voorkant gesloten



#	Pictogram	Item	Beschrijving
1		Stroomindicator ¹	Geeft de vermogenstatus van de computer aan.
		Accu-indicator ¹	Geeft de batterijstatus van de computer aan. 1. Opladen: Het licht is oranje wanneer de accu wordt opgeladen. 2. Volledig opgeladen: Het licht is blauw in de AC-modus.
2		Meer-in-één-kaartlezer	Accepteert Secure Digital (SD), MultiMediaCard (MMC), Memory Stick (MS), Memory Stick PRO (MS PRO) en xD-Picture Card (xD). Opmerking: Duwen om de kaart te verwijderen/plaatsen. Slechts één kaart tegelijk mag gebruikt worden.







Achterkant

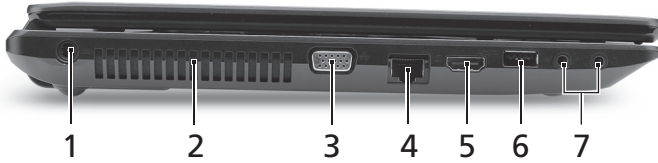

#	Pictogram	Item	Beschrijving
1		Accu	Levert de energie als de computer niet op het netstroom is aangesloten.



Linkerkant



#	Pictogram	Item	Beschrijving
1		Gelijkstroomaansluiting	Aansluiting voor een adapter.
2		Ventilatie-sleuven	Zorgen dat de computer koel blijft, zelfs na langdurig gebruik.
3		Externe weergavepoort (VGA)	Aansluiting voor een beeldscherm (bijv. een externe monitor, LCD-projector).
4		Ethernetpoort (RJ-45)	Aansluiting voor een Ethernet 10/100/1000-gebaseerd netwerk.
5		Hdmi-poort	Ondersteunt high-definition digitale videosignalen.
6		USB 2.0-poort	Aansluiting voor USB 2.0-apparaten (bijv. usb-muis, usb-camera).
7		Aansluiting voor Microfoon-in	Aansluitingen voor externe microfoon.
		Aansluiting voor hoofdtelefoon/luidspreker/lijn-uit	Aansluiting voor lijn-uit audioapparaten (bijv. luidsprekers, hoofdtelefoon).

Rechterkant





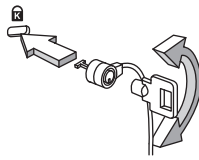

#	Pictogram	Item	Beschrijving
1		USB 2.0-poort	Aansluiting voor USB 2.0 apparaten (bijv. USB-muis, USB-camera).
2		Optisch station	Intern optisch station; accepteert CDs of DVDs.
3		Toegangsindicator optische schijf	Brandt wanneer het optisch station actief is.
4		Uitwerpknop optisch station	Werpt de optische schijf uit het station.
5		Nood-uitwerpopening	Opent de lade van het optisch station wanneer de computer is uitgeschakeld. Opmerking: Steek een paperclip in de nooduitwerpopening om de lade van het optisch station uit te werpen als de computer is uitgeschakeld.
6		Kensington-slot sleuf	Aansluiting voor een Kensington-compatibel computerbeveiligingsslot. Opmerking: Wikkel een kabel rond een vast, onwrikbaar object, zoals een tafel of een handgreep van een lade. Plaats het slot in de uitsparing en draai de sleutel om zodat het slot is vergrendeld. Er zijn ook modellen beschikbaar zonder Kensington-slot.

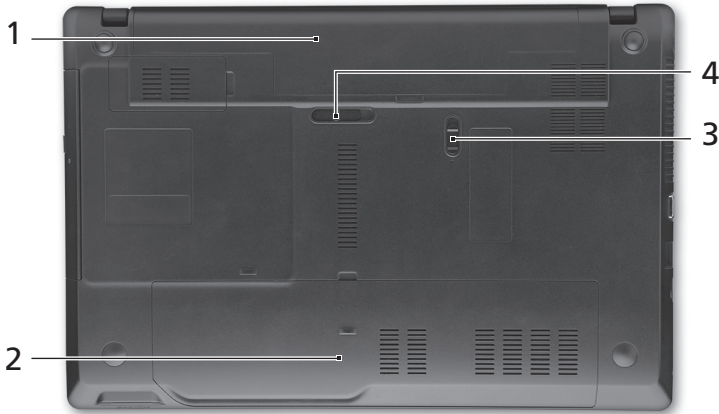

Onderkant



#	Pictogram	Item	Beschrijving
1		Batterijnis	Bevat de batterij van de computer.
2		Harde schijf nis	Bevat de harde schijf van de computer (vastgeschroefd).
		Geheugenvak	Bevat het hoofdgeheugen van de computer.
3		Batterijgrendel	Vergrendelt de accu op z'n plaats.
4		Batterijvergrendeling	Maakt de batterij los.

Omgeving

- **Temperatuur:**
 - In gebruik: 5°C tot 35°C
 - Niet in gebruik: -20°C tot 65°C
- **Vochtigheidsgraad (geen condensvorming):**
 - In gebruik: 20% tot 80%
 - Niet in gebruik: 20% tot 80%

TravelMate 5740/5740Z/5340- serien

Hurtigguide

© 2010 Med enerett.

Hurtigguide for TravelMate 5740/5740Z/5340-serien
Opprinnelig utgave: 03/2010

Notebook-PC i TravelMate 5740/5740Z/5340-serien

Modellnummer: _____

Serienummer: _____

Innkjøpsdato: _____

Innkjøpssted: _____

Begynne med begynnelsen

Vi vil gjerne takke deg for at du har valgt en Acer-notebook til dine mobile databehandlingsbehov.

Dine veiledere

Som hjelp til bruk av Acer-notebooken har vi utformet et sett av veiledere:

Til å begynne med vil **oppsettplakaten** hjelpe deg i gang med oppsettet av datamaskinen.

Den **generiske brukerveiledningen for TravelMate-serien** inneholder nyttig informasjon om alle modeller i TravelMate-produktserien. Den dekker grunnleggende emner som bruk av tastaturet og lyd, osv. Vennligst merk at **AcerSystem Brukerveiledning** som er nevnt nedenfor, fra tid til annen vil referere til funksjoner eller egenskaper som bare finnes på visse modeller i serien, men ikke nødvendigvis på den modellen du kjøpte. Slike forekomster er markert i teksten med språk som "bare for visse modeller".

I den trykte **Brukerhåndboken** får du en innføring i de grunnleggende egenskapene og funksjonene til den nye datamaskinen. Hvis du vil vite mer om hvordan datamaskinen kan gjøre deg mer produktiv, kan du slå opp i **AcerSystem User's Guide**. Denne håndboken inneholder detaljert informasjon om emner som systemverktøy, datagjenvinning, utvidelsesalternativer og feilsøking/problemløsning. I tillegg finner du garantiopplysninger, generell informasjon og sikkerhetsmerknader for notisbokmaskinen din. Boken er tilgjengelig som PDF-fil (Portable Document Format) og leveres forhåndslestet på maskinen. Følg disse trinnene for å åpne den:

- 1 Klikk på **Start > Alle programmer > AcerSystem**.
- 2 Klikk på **AcerSystem User's Guide**.



.....





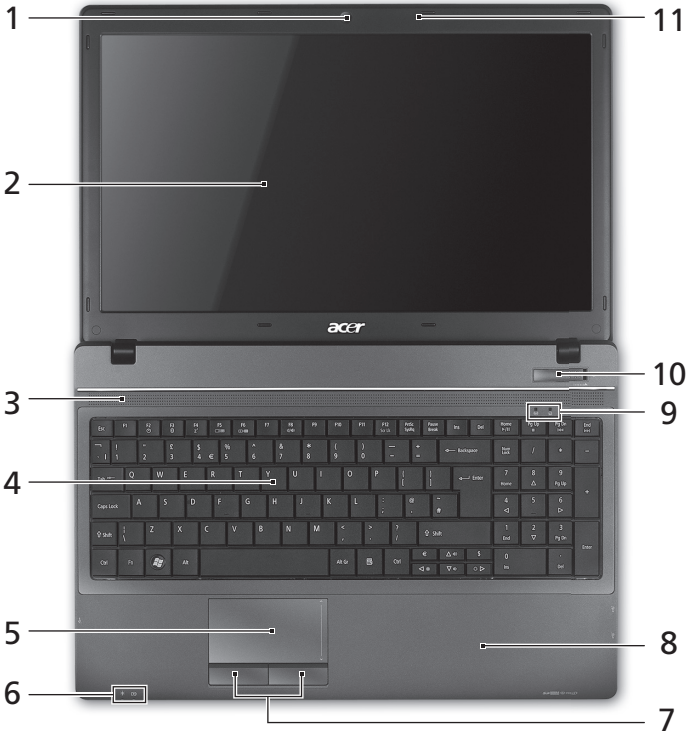

Merk: Visning av filen krever at du har Adobe Reader installert. Hvis Adobe Reader ikke er installert på datamaskinen din, vil klikking på **AcerSystem User's Guide** føre til at installeringsprogrammet for Adobe Reader kjøres i stedet. Følg instruksjonene på skjermen for å fullføre installeringen. Hvis du vil vite hvordan du bruker Adobe Reader, åpner du menyen **Hjelp og Støtte**.

En omvisning i Acer-notebooken

Når du har satt opp datamaskinen som vist på plakaten **Før vi begynner...**, la oss ta en omvisning i din nye Acer-datamaskin.

Visning ovenfra













#	Ikon	Element	Beskrivelse
1		Acer Crystal Eye-webkamera	Webkamera til videokommunikasjon (bare for visse modeller).
2		Skjerm	Kalles også LCD-skjerm (Liquid-Crystal Display; LCD), viser utdata fra datamaskinen (Konfigurasjonen kan variere mellom modellene).
3		Høytalere	Høytalere foran til venstre og foran til høyre sørger for stereolydeeffekt.
4		Tastatur	Legger inn data i datamaskinen.
5		Pekeplate	Pekeenhet som reagerer på berøring og fungerer som en mus.
6		Strømindikator ¹	Angir datamaskinens strømstatus.
		Batteriindikator ¹	Angir datamaskinens batteristatus. 1. Lading: Lampen lyser gult når batteriet lades. 2. Helt oppladet: Lampen lyser blått i nettstrømmodus.
7		Klikkeknapper (venstre og høyre)	Venstre og høyre knapp fungerer på samme måte som venstre og høyre museknapp.
8		Håndleddshviler	Komfortabelt støtteområde for hendene når du bruker datamaskinen.
9		HDD	Lyser når harddisken er aktiv.
		Kommunikasjonsindikator	Angir datamaskinens status for trådløs tilkobling.
10		Strømbryter	Slår datamaskinen av og på.
11		Mikrofon	Intern mikrofon for lydinnspilling.

1. Frontpanelindikatorene er synlige selv når skjermen er lukket.

Hurtigtaster



Datamaskinen bruker hurtigtaster eller tastekombinasjoner for å få tilgang til datamaskinens kontroller, for eksempel skjermens lysstyrke og volumutgang.

Når du skal aktivere hurtigtaster, trykker du på og holder <Fn>-tasten før du trykker på den neste tasten i hurtigtastkombinasjonen.

Hurtigtast	Ikone	Funksjon	Beskrivelse
<Fn> + <F3>		Kommunikasjon	Aktiverer/deaktiverer datamaskinens kommunikasjonsenheter. (Kommunikasjonsenheter kan variere i konfigurasjon.)
<Fn> + <F4>		Dvale	Setter datamaskinen i dvalemodus.
<Fn> + <F5>		Skjermbytte	Bytter mellom visning på vanlig skjerm, ekstern skjerm (hvis tilkoblet) eller begge deler.
<Fn> + <F6>		Visning av	Slå av skjermens bakgrunnsbelysning for å spare strøm. Trykk på en hvilken som helst tast for å gå tilbake.
<Fn> + <F7>		Berøringsplate av/på	Slår berøringsplaten på og av.
<Fn> + <F8>		Høytaler av/på	Slår høytalerne av og på.
<Fn> + <Δ>		Volum opp	Øker lydvolument.
<Fn> + <▽>		Volum ned	Reduserer lydvolument.
<Fn> + <▷>		Lysstyrke opp	Øker skjermens lysstyrke.
<Fn> + <◁>		Lysstyrke ned	Reduserer skjermens lysstyrke.

Lukket frontvisning



#	Ikon	Element	Beskrivelse
1		Strømindikator ¹	Angir datamaskinens strømstatus.
		Batteriindikator ¹	Angir datamaskinens batteristatus. 1. Lading: Lampen lyser gult når batteriet lades. 2. Helt oppladet: Lampen lyser blått i nettstrømmodus.
2		Multi-i-1-kortleser	Godtar Secure Digital (SD), MultiMediaCard (MMC), Memory Stick (MS), Memory Stick Pro (MS PRO), og xD-Picture Card (xD). Merk: Skyv inn for å fjerne/installere kortet. Bare ett kort kan operere til enhver tid.



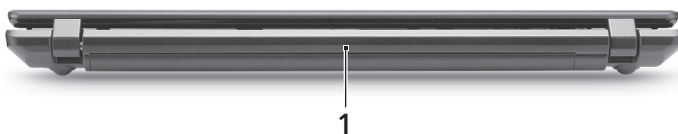



Bakre visning

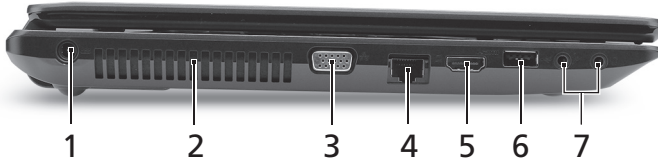

#	Ikon	Element	Beskrivelse
1		Batteriindikator	Gir strøm til datamaskinen når den ikke er koblet til.



Venstre visning



#	Ikon	Element	Beskrivelse
1		Strømtilkobling	Kobler til en batterieliminatør.
2		Ventilasjonsåpninger	Gir datamaskinen mulighet til å holde seg kjølig, selv etter lang tids bruk.
3		Port for ekstern skjerm (VGA)	Kobler til en skjermenhet (f.eks. ekstern skjerm, LCD-projektor).
4		Ethernet-port (RJ-45)	Kobler til et Ethernet 10/100/1000-basert nettverk.
5		HDMI-port	Støtter høydefinisjons digitale videoforbindelser.
6		USB 2.0-port	Kobler til USB 2.0-enheter (f.eks. USB-mus, USB-kamera).
7		Mikrofonplugg	Mottar inndata fra eksterne mikrofoner.
		Hodetelefon/høytalere/line-out-port	Kobles til utdataenheter for lyd (f.eks. høytalere, hodetelefon).

Høyre visning





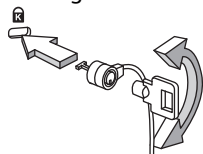

#	Ikon	Element	Beskrivelse
1		USB 2.0-port	Kobler til USB 2.0-enheter (f.eks. USB-mus, USB-kamera).
2		Optisk stasjon	Intern optisk stasjon. Godtar CDer og DVDer.
3		Tilgangssindikator for optisk disk	Lyser når den optiske stasjonen er aktiv.
4		Utløserknapp for optisk stasjon	Løser ut den optiske disken fra stasjonen.
5		Nødutløserhull	Løser ut platen i den optiske stasjonen når datamaskinen er slått av. Merk: Sett en binders i nødutløserhullet hvis du må løse ut den optiske stasjonen når datamaskinen er av.
6		Spor for Kensington-lås	Kobler til en Kensington-kompatibel sikkerhetslås for datamaskinen. Merk: Koble en sikkerhetslås rundt et ubevegelig objekt som et bord eller håndtaket på en låst skuff. Sett inn låsen i sporet og vri om nøkkelen for å låse. Noen nøkkelløse modeller er også tilgjengelige.

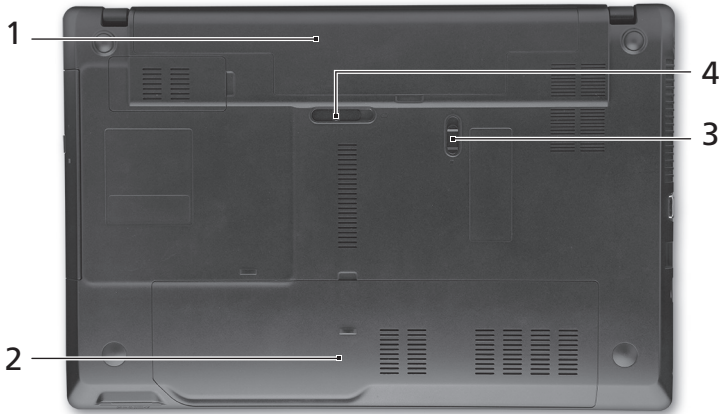

Bunnvisning



#	Ikon	Element	Beskrivelse
1		Batterirom	Huser datamaskinens batterier.
2		Harddiskplass	Huser datamaskinens harddisk (sikret med skruer).
		Minnerom	Huser datamaskinens hovedminne.
3		Batterilås	Låser batteriet på plass.
4		Batterifrigivelsesbolt	Frigir batteriet for fjerning.

Miljø

- Temperatur:
 - Drift: 5°C til 35°C
 - Ikke i bruk: -20°C til 65°C
- Luftfuktighet (ikke-kondenserende):
 - Drift: 20% til 80%
 - Ikke i bruk: 20% til 80%

TravelMate 5740/5740Z/5340 Seriens

Hurtig-guide

© 2010 Alle Rettigheder Forbeholdes.

TravelMate 5740/5740Z/5340 Seriens Hurtig-guide
Oprindeligt udgivet: 03/2010

TravelMate 5740/5740Z/5340 seriens notebook-pc

Modelnummer: _____

Serienummer: _____

Købsdato: _____

Købt hos: _____

For det første

Vi vil gerne takke for, at du har valgt en Acer bærbar til at opfylde dine mobile computerbehov.

Dine vejledninger

Vi har udarbejdet et sæt vejledninger til at hjælpe dig med at anvende din Acer notebook.

Til at begynde med, kan **konfigurationsplakaten** hjælpe dig til at komme i gang med konfigurationen af computeren.

TravelMate-seriens Fælles brugervejledning indeholder nyttige oplysninger, der gælder alle modellerne i TravelMate-produktserien. Den dækker grundlæggende emner som brugen af tastaturet og lyd osv. Husk venligst, at den neden for nævnte **AcerSystem-brugervejledning** nogle gange henviser til funktioner, der kun findes på udvalgte modeller og ikke nødvendigvis i den model du købte. Sådanne tilfælde er markeret i teksten med f.eks. "kun på visse modeller".

Den trykte **Hurtigvejledning** beskriver de grundlæggende funktioner ved din nye computer. Du kan finde flere oplysninger om, hvordan computeren kan hjælpe dig til at blive mere produktiv, i **AcerSystem User's Guide**.

Denne vejledning indeholder detaljerede oplysninger om emner som systemprogrammer, datagendannelse, udvidelsesmuligheder og fejlfinding. Derudover indeholder den garantioplysninger og generelle regulativer og sikkerhedsmeddelelser til din bærbare. Den findes i Portable Document Format (PDF) og leveres forudinstalleret på din bærbare. Følg disse trin for at få adgang til den:

- 1 Klik på **Start > Alle programmer > AcerSystem**.
- 2 Klik på **AcerSystem User's Guide**.



.....





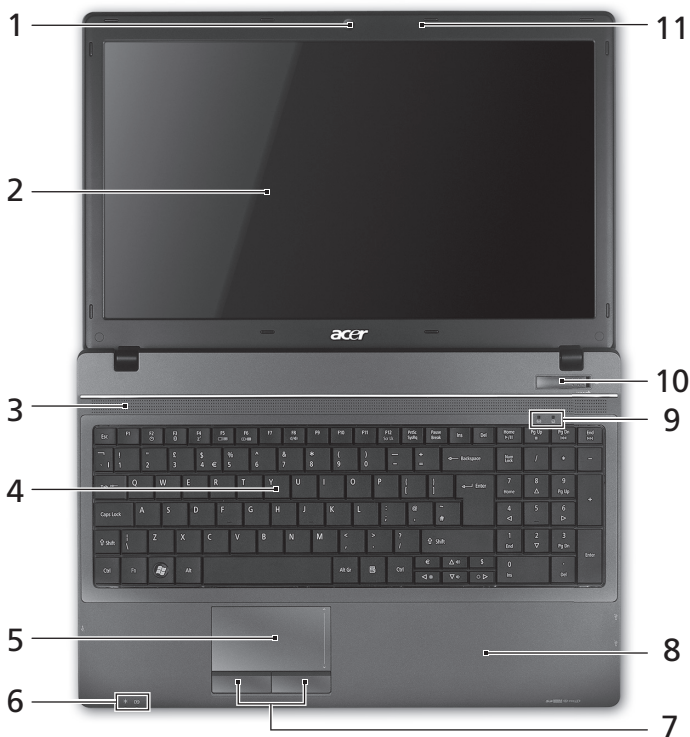

Bemærk: For at få vist filen skal du have Adobe Reader installeret. Hvis Adobe Reader ikke er installeret på din computer, kører installationsprogrammet til Adobe Reader automatisk, når du klikker på **AcerSystem User's Guide**. Følg instruktionerne på skærmen for at fuldføre installationen. Yderligere oplysninger om, hvordan du bruger Adobe Reader, finder du i menuen **Hjælp og support**.

En præsentation af din Acer notebook

Når du har sat computeren op som vist på illustrationerne på plakaten **Sådan kommer du i gang...**, vil vi gerne give dig en rundtur i din nye Acer notebook.

Fra oven













#	Ikon	Emne	Beskrivelse
1		Acer Crystal Eye webcam	Webkamera til videokommunikation (kun på visse modeller).
2		Skærm	Det kaldes også for et LCD (Liquid-Crystal Display - flydende krystaldisplay), og det viser computerens output (Konfiguration kan variere fra model til model).
3		Højtalere	Højtalere foran til venstre og højre udsender lyd i stereo.
4		Tastatur	Til indtastning af data på computeren.
5		Touchpad (pegefelt)	Et berøringsfølsomt pegeredskab, der fungerer ligesom en computermus.
6		Strømindikator ¹	Angiver computerens strømstatus.
		Batteriindikator ¹	Angiver computerens batteristatus. 1. Oplader: Lampen lyser gult, når batteriet oplader. 2. Fuldt opladet: Lampen lyser blå i AC-tilstand.
7		Klik på knapperne (til venstre og til højre)	Knapperne til højre og venstre fungerer på samme måde som musens højre og venstre knapper.
8		Håndfladestøtte	Et komfortabelt støtteområde for dine hænder, når du bruger computeren.
9		HDD	Lyser, når harddisken er aktiv.
		Kommunikationsindikator	Angiver status for computerens trådløse enhedsforbindelse.
10		Strømafbryder	Tænder/slukker for computeren.
11		Mikrofon	Intern mikrofon til optagelse af lyd.

1. Frontpanelets indikatorer er synlige, selvom computerens låg er lukket.

Hurtigtaster



Computeren bruger hurtigtaster eller tastkombinationer til at få adgang til de fleste af computerens kontroller som skærmens lysstyrke og lydstyrke.

Hvis du vil aktivere hurtigtaster, skal du holde **<Fn>** -tasten nede og derefter trykke på den anden tast i hurtigtastkombinationen.

Hurtigtast	Ikone	Funktion	Beskrivelse
<Fn> + <F3>		Kommunikation	Aktiverer/deaktiverer computerens kommunikationsenheder. (Kommunikationsenheder kan variere efter konfiguration.)
<Fn> + <F4>		Dvale	Sætter computeren i dvaletilstand.
<Fn> + <F5>		Skærm til/fra	Skifter skærmoutputtet mellem skærmen, en ekstern skærm (hvis den er tilsluttet) og begge to.
<Fn> + <F6>		Skærm fra	Slukker for skærmens baggrundslys for at spare strøm. Tryk på en vilkårlig tast for at fortsætte.
<Fn> + <F7>		Pegefelt til/fra	Tænder og slukker for pegefeltet.
<Fn> + <F8>		Højttaler til/fra	Tænder og slukker for højttalerne.
<Fn> + <Δ>		Lydstyrke op	Forøger højttalerens lydstyrke.
<Fn> + <▽>		Lydstyrke ned	Reducerer højttalerens lydstyrke.
<Fn> + <▷>		Lysstyrke op	Forøger skærmens lysstyrke.
<Fn> + <◁>		Lysstyrke ned	Formindsker skærmens lysstyrke.

Forfra - Lukket



#	Ikon	Emne	Beskrivelse
1		Strømindikator ¹	Angiver computerens strømstatus.
		Batteriindikator ¹	Angiver computerens batteristatus. 1. Oplader: Lampen lyser gult, når batteriet oplader. 2. Fuldt opladet: Lampen lyser blå i AC-tilstand.
2		Flere-i-en-kortlæser	Accepterer Secure Digital (SD), MultiMediaCard (MMC), Memory Stick (MS), Memory Stick PRO (MS PRO), og xD-Picture Card (xD). Bemærk: Skub for at fjerne/installere kortet. Der kan kun være et kort aktivt ad gangen.



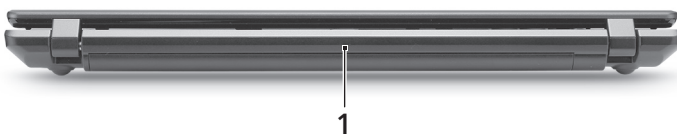



Set bagfra

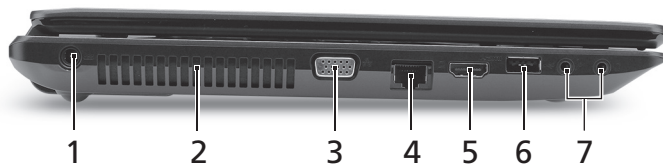

#	Ikon	Emne	Beskrivelse
1		Pil	Leverer strøm til computeren, så den kan bruges, når den ikke er strømført.



Fra venstre



#	Ikon	Emne	Beskrivelse
1		Jævnstrøm ind-stik	Tilslutter til en AC-adapter.
2		Ventilationsåbninger	Lader computeren være kølig selv efter lang tids brug.
3		Stik til ekstern skærm (VGA)	Tilslutter til en skærmenhed (f.eks. ekstern skræm, LCD-projektor).
4		Netværksport (RJ-45)	Til tilslutning af et Ethernet 10/100/1000-baseret netværk.
5		HDMI-port	Understøtter high-definition digitale netværksforbindelser.
6		USB 2.0-port	De er beregnet til tilslutning af to USB 2.0-enheder (f. eks. en USB-mus, USB-kamera).
7		Mikrofonstik	Accepterer input fra eksterne mikrofoner.
		Hovedtelefoner/ højtalere/linje ud-stik	Der kan tilsluttes ekstraudstyr (f. eks. højttalere, hovedtelefoner).

Fra højre





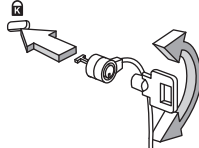

#	Ikon	Emne	Beskrivelse
1		USB 2.0-port	De er beregnet til tilslutning af to USB 2.0-enheder (f. eks. en USB-mus, USB-kamera).
2		Optisk drev	Internt optisk drev; accepterer CD'er og DVD'er.
3		Optisk disk - adgangsindikator	Lyser når det optiske drev er aktivt.
4		Udløserknap for det optiske drev	Skubber den optiske disk ud ad drevet.
5		Mekanisk udløserhul	Det åbner skuffen til det optiske drev, når computeren er slukket. Bemærk: Indsæt en papirklips i hullet til nødudskubning for at skubbe den optiske drevbakke ud, når computeren er slukket.
6		Åbning til en Kensington-lås	Tilslutter til en Kensington-kompatibel computers sikkerhedslås. Bemærk: Sno kablet til computersikkerhedslåsen rundt om en fast genstand, f.eks. et bord eller et håndtag på en låst skuffe. Sæt låsen i indhakkets, og drej nøglen, så låsen sættes fast. Der findes også modeller uden nøgle.

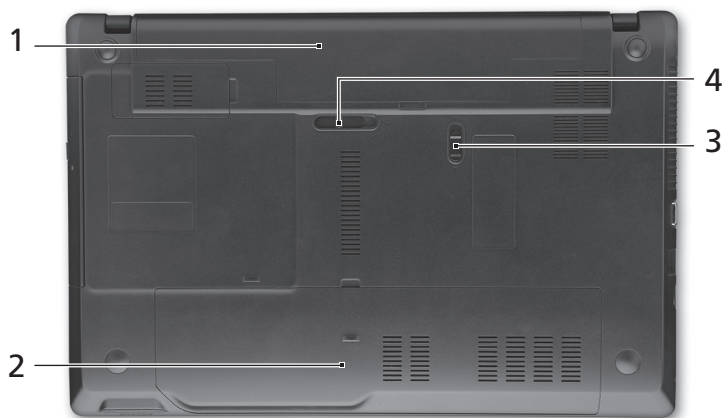

Set fra bunden



#	Ikon	Emne	Beskrivelse
1		Batterirum	Indeholder computerens batteri.
2		Harddiskbås	Indeholder computerens harddisk (fastsat med skruer).
		Hukommelsesrum	Her sidder computerens centrale hukommelse.
3		Batterilås	Låser batteriet på plads.
4		Frigørelsesarm til batteri	Frigør batteriet til udtagning.

Omgivelser

- Temperatur:
 - Under brug: 5°C til 35°C
 - Ikke i brug: -20°C til 65°C
- Fugtighed (ikke-kondenserende):
 - Under brug: 20% til 80%
 - Ikke i brug: 20% til 80%

TravelMate 5740/ 5740Z/5340-serien

Snabbguide

© 2010 Med ensamrätt.

TravelMate 5740/5740Z/5340-serien - Snabbguide
Ursprunglig utgåva: 03/2010

TravelMate 5740/5740Z/5340-serien – bärbar PC-dator

Modellnummer: _____

Serienummer: _____

Inköpsdatum: _____

Inköpsställe: _____

Först och främst

Vi vill tacka för att du valde en bärbar Acer-dator för att uppfylla dina behov av mobil databehandling.

Dina guider

Vi har tagit fram en uppsättning guider som hjälper vid användning av din bärbara Acer-dator:

Till att börja med finns **instruktionsfoldern** som hjälper dig komma igång med installationen av datorn.

Den tryckta **Allmän guide för TravelMate-serien** innehåller användbar information som gäller alla modeller i TravelMate-produktserien. Den omfattar grundläggande ämnen som användning av tangentbordet, ljud, osv. Var medveten om att **AcerSystem User's Guide** som nämns nedan till följd av sin natur då och då hänvisar till funktioner som bara finns i vissa av seriens modeller men inte nödvändigtvis i den modell som du har köpt. Sådana förekomster markeras i texten med "bara för vissa modeller".

I denna tryckta **Snabbguide** presenteras de grundläggande funktionerna i din nya dator. Mer information om hur datorn kan hjälpa dig att bli mer produktiv finns i **AcerSystem User's Guide**. Denna handbok innehåller detaljerad information om ämnen som systemverktyg, dataåterhämtning, expansionsalternativ och felsökning. Dessutom innehåller den garantiinformation samt allmänna föreskrifter och säkerhetsmeddelanden angående den bärbara datorn. Den finns i Portable Document Format (PDF) och har förladdats i den bärbara datorn. Följ de här stegen för att få tillgång till den:

- 1 Välj **Start**, > **Alla program** > **AcerSystem**.
- 2 Dubbelklicka på **AcerSystem User Guide**.







Obs! Du måste ha Adobe Reader installerat för att kunna visa filen. Om Adobe Reader inte är installerat på datorn kommer det att installeras när du dubbelklickar på **AcerSystem User's Guide**. Följ anvisningarna på skärmen för att genomföra installationen. Instruktioner för hur du använder Adobe Reader finns på menyn **Hjälp och Support**.

Beskrivning av din bärbara Acer-dator

När du har installerat datorn enligt illustration på instruktionsfolder **Börja med att läsa detta...** vill vi beskriva din nya bärbara Acer-dator.

Vy över ovasidan







#	Ikon	Objekt	Beskrivning
1		Acer Crystal Eye webbkamera	Webbkamera för videokommunikation (bara för vissa modeller).
2		Bildskärm	Kallas även Liquid-Crystal Display (LCD), visar utdata från datorn (Konfigurationen kan variera med olika modeller).
3		Högtalare	Den främre vänstra och främre högra högtalaren ger stereoljud.
4		Tangentbord	För inmatning av data i datorn.
5		Pekplatta	Beröringskänslig pekenhet som fungerar som en datormus.
6		På-indikator ¹	Anger om datorn är av eller på.
		Batteriindikator ¹	Anger status för datorns batteri. 1. Laddar: Lyser orange när batteriet laddas. 2. Fulladdad: Lyser blått då datorn är ansluten till nätström.
7		Klickknappar (vänster och höger)	Vänster och höger knapp fungerar som vänster och höger musknapp.
8		Handlovsstöd	Handlovsstödet ger bekvämt stöd för händerna när du använder datorn.
9		HDD	Tänds när hårddisken arbetar.
		Kommunikationsindikator	Anger status för datorns trådlösa anslutningsenhet.
10		Strömbrytare	Slår på och stänger av datorn.
11		Mikrofon	Inbyggd mikrofon för ljudinspelning.

1. Indikatorerna på frontpanelen syns även när datorhöljet är stängt.

Snabbtangenter

Datorn använder snabbtangenter eller tangentkombinationer för att komma åt de flesta av datorns kontroller som t.ex. skärmens ljusstyrka och volym.

Du aktiverar en snabbtangent genom att hålla ned <Fn> innan du trycker på den andra tangenten i snabbtangentskombinationen.

Snabbtangent	Ikon	Funktion	Beskrivning
<Fn> + <F3>		Kommunikation	Aktiverar/avaktiverar datorns kommunikationsenheter. (Kommunikationsenheterna kan variera beroende på konfiguration.)
<Fn> + <F4>		Vänteläge	Placerar datorn i vänteläge.
<Fn> + <F5>		Växla bildskärm	Växlar visning mellan datorns bildskärm och en extern monitor (om ansluten) och båda.
<Fn> + <F6>		Bildskärm av	Stänger av bildskärmens bakgrundsbelysning för att spara ström. Återgå genom att trycka på en valfri tangent.
<Fn> + <F7>		Aktivera pekplatta	Slår på och stänger av pekplattan.
<Fn> + <F8>		Aktivera/avaktivera högtalare	Sätter på/stänger av högtalarna.
<Fn> + <Δ>		Volym upp	Höjer högtalarvolymen.
<Fn> + <▽>		Volym ned	Sänker högtalarvolymen.
<Fn> + <▷>		Öka ljusstyrkan	Ökar bildskärmens ljusstyrka.
<Fn> + <◁>		Minska ljusstyrka	Minskar bildskärmens ljusstyrka.

Vy över stängd framsida



#	Ikon	Objekt	Beskrivning
1		På-indikator ¹	Anger om datorn är av eller på.
		Batteriindikator ¹	Anger status för datorns batteri. 1. Laddar: Lyser orange när batteriet laddas. 2. Fulladdad: Lyser blått då datorn är ansluten till nätström.
2		Flera-i-1-kortläsare	Avsedd för Secure Digital (SD), MultiMediaCard (MMC), Memory Stick (MS), Memory Stick PRO (MS PRO), xD-Picture Card (xD). Obs! Tryck för att ta bort/sätta i kortet. Endast ett enda kort kan vara aktivt åt gången.







Vy bakifrån

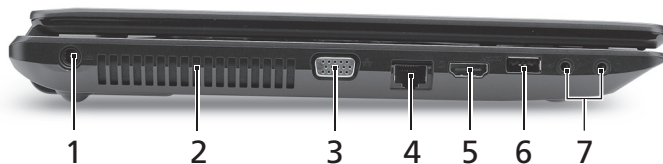

#	Ikon	Objekt	Beskrivning
1		Batteriladdning	Försörjer datorn med ström när den används utan att vara nätansluten.



Vy från vänster



#	Ikön	Objekt	Beskrivning
1		DC in-anslutning	Ansluts till en växelströmsadapter.
2		Ventilationsöppningar	Möjliggör att datorn håller sig sval, även efter långvarig användning.
3		Port för extern bildskärm (VGA)	Anslutning till en visningsenhet (t.ex. extern bildskärm, LCD-projektor).
4		Ethernet-port (RJ-45)	Ansluts till ett Ethernet 10/100/1000-baserat nätverk.
5		HDMI-port	Har stöd för digitala videoanslutningar av högdefinitionstyp.
6		USB 2.0-port	Ansluts till USB 2.0-enheter (t.ex. USB-mus, USB-kamera).
7		Ingång för mikrofon	Anslutning för externa mikrofoner.
		Utgång för hörlurar/högtalare/linje ut	Ansluts till ljud ut-enheter (t.ex. högtalare, hörlurar).

Vy från höger





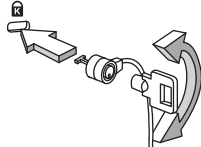

#	Ikön	Objekt	Beskrivning
1		USB 2.0-port	Ansluts till USB 2.0-enheter (t.ex. USB-mus, USB-kamera).
2		Optisk läsenhet	Inbyggd optisk läsenhet för CD- eller DVD-skivor.
3		Åtkomstindikator för optisk läsenhet	Tänds när den optiska läsenheten arbetar.
4		Utmatningsknapp för optisk läsenhet	Matar ut skivan från den optiska läsenheten.
5		Häl för mekanisk utmatning	Matar ut skivluckan från den optiska läsenheten när datorn är avstängd. Obs! För in spetsen på ett gem i det mekaniska utmatningshålet för att mata ut det optiska enhetsfacket när datorn är avslagen.
6		Skåra för Kensingtonlås	Ansluts till ett Kensington-kompatibelt datorskyddslås. Obs! Lägg en låsvajer runt ett fast föremål, t.ex. ett bord eller handtaget till en låst skrivbordslåda. Sätt in låset i uttaget och lås det sedan genom att vrida om nyckeln. Vissa modeller är dock nyckellösa.

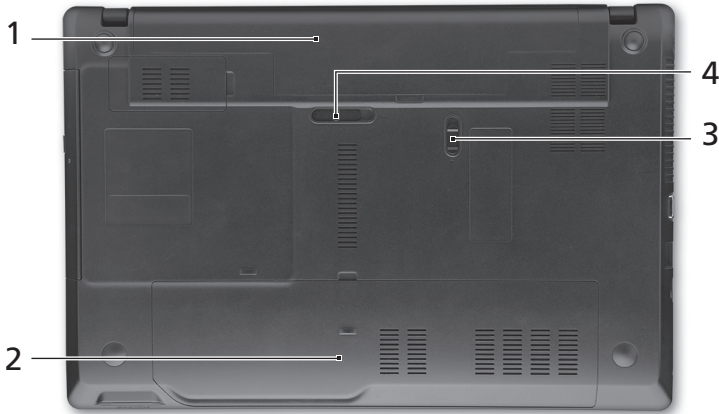

Vy underifrån



#	Ikon	Objekt	Beskrivning
1		Batterifack	Avsett för datorns batteripack.
2		Hårddiskfack	Utrymme för datorns hårddisk (fastskruvad).
		Minnesfack	Här finns datorns huvudminne.
3		Batterilås	Låser batteriet på plats.
4		Hake för frigöring av batteriet	Frigör batteriet före borttagning.

Miljö

- Temperatur:
 - Vid drift: 5°C till 35°C
 - Utom drift: -20°C till 65°C
- Luftfuktighet (icke-kondenserande):
 - Vid drift: 20% till 80%
 - Utom drift: 20% till 80%

TravelMate 5740/ 5740Z/5340 -sarja

Pikaohje

© 2010 Kaikki oikeudet pidätetään.

TravelMate 5740/5740Z/5340 -sarjan Pikaohje
Ensimmäinen julkistus: 03/2010

TravelMate 5740/5740Z/5340 -sarjan Kannettava tietokone

Mallinumero: _____

Sarjanumero: _____

Ostopäivämäärä: _____

Ostopaikka: _____

Aloitetaan perusasioista

Haluamme kiittää sinua Acerin kannettavan tietokoneen valitsemisesta liikkuvien tietokonetarpeittesi täyttämässä.

Ohjeet

Helpottaaksesi sinua Acer-tietokoneen käyttämisessä olemme suunnitelleet sarjan ohjekirjoja:

Ihan aluksi **juliste** auttaa sinua tietokoneen käyttöönotossa.

TravelMate Series Generic Guide (TravelMate-sarjan perusopas) sisältää hyödyllisiä tietoja, jotka käyvät TravelMate -tuotesarjan kaikille malleille. Se kattaa perusaiheet kuten näppäistön, äänen, jne. käyttämisen.

On ymmärrettävä, että luonteestaan johtuen, alla mainittu **AcerSystem Käyttäjän ohje** viittaa ajoittain toimintoihin tai ominaisuuksiin, jotka on sisällytetty vain tiettyihin sarjan malleihin, mutta ei välttämättä ostamaasi malliin. Sellaiset tapaukset on merkitty tekstissä kyseisellä kielellä "vain tietyille malleille".

Tämä **Pikaohje** esittelee uuden tietokoneesi perusominaisuudet ja -toiminnot. Saadaksesi lisätietoja siitä, miten tietokoneesi voi auttaa sinua lisäämään tuottavuutta, katso **AcerSystem User Guide**. Tässä ohjeessa on yksityiskohtaiset ohjeet järjestelmätoiminnoista, tietojen palauttamisesta, tietokoneen laajentamisesta ja ongelmanratkaisusta. Siinä on myös annettu yleisiä ohjeita, tietoja takuusta sekä turvallisuusohjeita. Se on saatavana Portable Document Format (PDF) -muodossa, ja ja tulee esiasennettuna tietokoneellesi. Seuraa näitä ohjeita siihen pääsemiseksi:

- 1 Napsauta **Käynnistä > Kaikki ohjelmat > AcerSystem**.
- 2 Napsauta **AcerSystem User Guide**.



.....

Huomautus: Jotta voit näyttää tiedoston, Adobe Readerin on oltava asennettu. Jos Adobe Reader ei ole asennettu tietokoneessasi, napsauttamalla **AcerSystem User Guide** se suorittaa ensin Adobe Reader -asennusohjelman. Noudata näytölle tulevia ohjeita, kunnes asennus on valmis. Saat lisätietoja Adobe Readerin käytöstä valikosta **Ohje ja tukikeskus**.

Tutustuminen Acerin kannettavaan tietokoneeseen

Kun olet asentanut tietokoneesi kuten **Aloittelijoille...** -tiedotteessa on kerrottu, anna meidän esitellä uusi kannettava Acer-tietokoneesi.

Näkymä ylhäältä

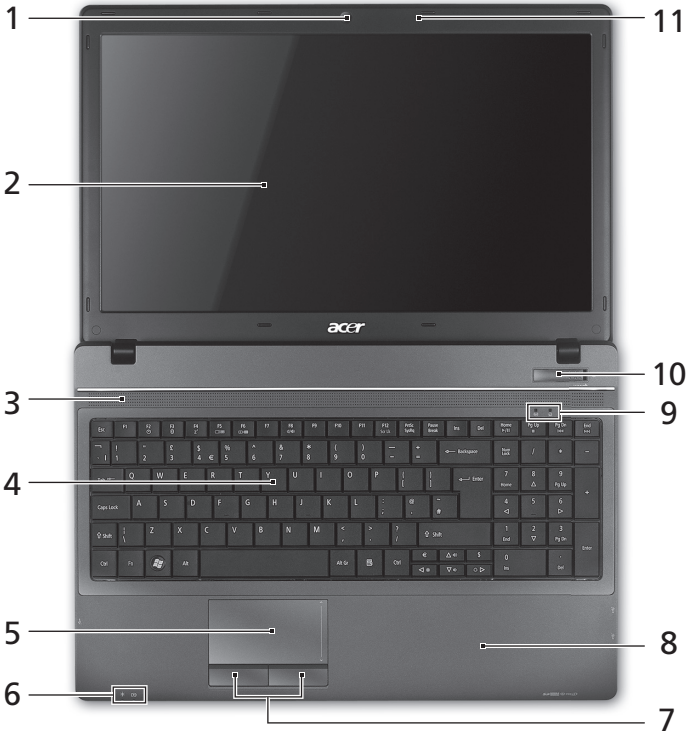



#	Kuvake	Osoie	Kuvaus
1		Acer Crystal Eye -webkamera	Web-kamera video-tietoliikenteeseen (vain valituille malleille).
2		Näyttöruutu	Nimeltään myös nestekidenäyttö (Liquid-Crystal Display ; LCD), näyttää tietokoneen ulostulon (Konfiguraatio voi vaihdella malleista riippuen).
3		Kaiuttimet	Edessä vasemmalla, ja edessä oikealla sijaitsevat kaiuttimet tuottavat stereoääntä.
4		Näppäimistö	Tiedon syöttämiseen tietokoneelle.
5		Kosketusalusta	Kosketusherkkä osoitinlaite, joka toimii kuten tietokoneen hiiri.
6		Virranilmaisim ¹	Osoittaa tietokoneen virran tilan.
		Akkutilan ilmaisim ¹	Osoittaa tietokoneen akun tilan. 1. Lataus meneillään: Valo palaa oranssina, kun akku latautuu. 2. Täyteen ladattu: Valo palaa sinisenä, kun tietokone toimii verkkovirralla.
7		Napsauta painikkeita (vasen ja oikea)	Vasen ja oikea painike toimivat kuten hiiren vasen ja oikea painike.
8		Rannetuki	Mukava tuki käsillesi konetta käyttäessäsi.
9		HDD	Palaa, kun kiintolevy on aktiivinen.
		Kommunikoinnin ilmaisim	Osoittaa tietokoneen langattoman yhdistettävyyden laitetilan.
10		Virtakytkin	Käynnistää ja sulkee koneen.
11		Mikrofoni	Sisäinen mikrofoni äänen tallentamista varten.

1. Etupaneelin tilailmaisimet näkyvät, vaikka tietokoneen kansi olisi suljettu.

Pikavalintanäppäimet

Tietokoneessa on pikavalintanäppäimet tai näppäinyhdistelmät sen useimpia säätöjä, kuten näyttöruudun kirkkautta, äänenvoimakkuutta varten.

Aktivoidaksesi pikavalintanäppäimet paina ja pidä painettuna **<Fn>** -näppäintä ja paina sitten pikavalintanäppäinyhdistelmän toista näppäintä.

Pikanäppäin	Kuvake	Toiminto	Kuvaus
<Fn> + <F3>		Tietoliikenne	Ottaa käyttöön/poistaa käytöstä tietokoneen tietoliikennelaitteet. (Tietoliikennelaitteet voivat vaihdella konfiguroinnilla.)
<Fn> + <F4>		Lepotila	Siirtää tietokoneen lepotilaan.
<Fn> + <F5>		Näytön vaihto	Kytkee näytön ulostulon näyttöruudun, ulkoisen monitorin (jos kytketty) ja molempien välillä.
<Fn> + <F6>		Näyttö pois	Sammuttaa näytön taustavalon virran säästämiseksi. Paina mitä tahansa näppäintä palataksesi normaalitilaan.
<Fn> + <F7>		Kosketusalustan vaihtokytkin	Käynnistää ja sulkee kosketusalustan.
<Fn> + <F8>		Kaiuttimien vaihtokytkin	Kytkee kaiuttimet käyttöön ja pois käytöstä.
<Fn> + <▲>		Äänenvoimakkuus ylös	Lisää äänenvoimakkuutta.
<Fn> + <▼>		Äänenvoimakkuus alas	Vähentää äänenvoimakkuutta.
<Fn> + <▶>		Kirkkauden lisäys	Lisää näytön kirkkautta.
<Fn> + <◀>		Kirkkauden vähennys	Vähentää näytön kirkkautta.

Etunäkymä suljettuna



#	Kuvake	Osio	Kuvaus
1		Virranilmais ¹	Osoittaa tietokoneen virran tilan.
		Akkutilan ilmais ¹	Osoittaa tietokoneen akun tilan. 1. Lataus meneillään: Valo palaa oranssina, kun akku latautuu. 2. Täyteen ladattu: Valo palaa sinisenä, kun tietokone toimii verkkovirralla.
2		Monta yhdessä - kortinlukija	Hyväksyy seuraavat muistikortit: Secure Digital (SD), MultiMediaCard (MMC), Memory Stick (MS), Memory Stick PRO (MS PRO) ja xD-Picture Card (xD). Huomautus: Poista/Asenna kortti työntämällä. Vain yksi kortti voi toimia mihin aikaan hyvänsä.







Taustanäkymä

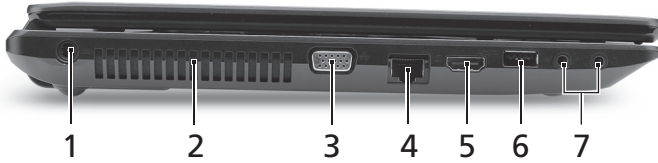

#	Kuvake	Osio	Kuvaus
1		Akku	Tarjoaa virtaa tietokoneelle käytettäessä siitä koneen ollessa irrotettuna.



Vasen näkymä



#	Kuvake	Osio	Kuvaus
1		DC-tulolinja	Yhdistää AC-sovittimeen.
2		Tuuletuspaikat	Mahdollistaa tietokoneen pysymisen viileänä jopa pitkitetyn käytön jälkeen.
3		Ulkoinen näyttöportti (VGA)	Yhdistä näyttölaitteeseen (esim. ulkoinen monitori, LCD-projektori).
4		Ethernet (RJ-45)-portti	Yhdistää Ethernet 10/100/1000 -pohjaiseen verkkoon.
5		HDMI-portti	Tukee korkealaatuisia digitaalisia videoliitäntöjä.
6		USB 2.0 -portti	Yhdistää USB 2.0 -laitteisiin (esim. USB-hiiri, USB-kamera).
7		Mikrofonin tulolinja	Hyväksyy syötteen ulkoisilta mikrofoneilta.
		Kuulokkeet/kaiutin/jakkiliitäntä	Yhdistää audioliitäntälaitteisiin (esim. kaiuttimet, kuulokkeet).

Oikea näkymä



#	Kuvake	Osio	Kuvaus
1		USB 2.0 -portti	Yhdistää USB 2.0 -laitteisiin (esim. USB-hiiri, USB-kamera).
2		Optinen asema	Sisäinen optinen levyasema, hyväksyy CD:t ja DVD:t.
3		Optisen levyn tilan osoitin	Syttyy, kun optinen asema on aktiivinen.
4		Optisen aseman ulostyöntöpainike	Työntää optisen levykkeen ulos asemasta.
5		Hätäulostyöntöaukko	Työntää ulos optisen aseman kelkan, kun tietokone on sammutettu. Huomautus: Pane paperiliitin hätäpoistoreikään optisen aseman tarjottimen poistamiseksi asemasta, kun tietokone on pois päältä.
6		Kensington-lukon paikka	Yhdistää Kensington-yhteensopivaan tietokoneen turvalukkoon. Huomautus: Kierrä tietokoneen turvalukon kaapeli kiinteän esineen, kuten pöydän tai lukitun laatikon kahvan ympärille. Paina lukko paikalleen ja lukitse se kiertämällä avainta. Saatavana on myös joitakin avaimettomia lukkoja.

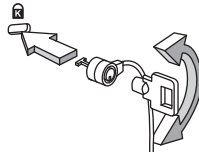

Pohjanäkymä

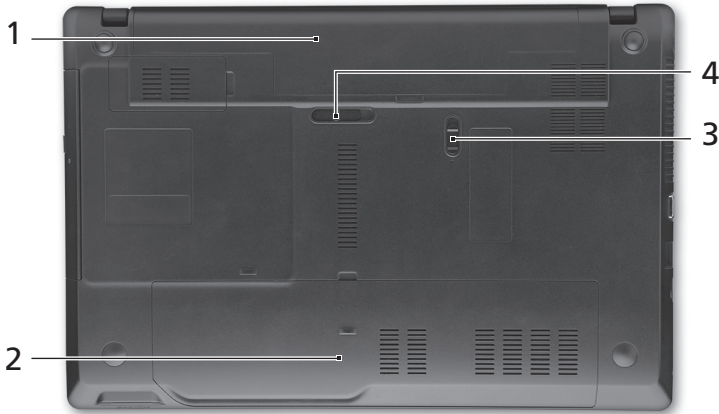

#	Kuvake	Osio	Kuvaus
1		Akkutila	Sisältää tietokoneen akkuyksikön.
2		Kovalevytila	Sisältää koneen kovalevyn (varmistettu ruuveilla).
		Muistilokero	Sisältää tietokoneen päämuisti.
3		Akun lukko	Lukitsee akun paikoilleen.
4		Akun vapautussalpa	Vapauttaa akun poistamista varten.

Ympäristö

- Lämpötila:
 - Käyttö: 5°C - 35°C
 - Ei käytössä: -20°C - 65°C
- Kosteus (ei kondensoitunut):
 - Käyttö: 20%:sta 80%:een
 - Ei käytössä: 20%:sta 80%:een

Серия TravelMate 5740/ 5740Z/5340

Краткое руководство

© 2010 Все права сохранены.

Краткое руководство по компьютеру серии TravelMate 5740/5740Z/5340
Первый выпуск: 03/2010

Портативный компьютер серии TravelMate 5740/5740Z/5340

Номер модели: _____

Серийный номер: _____

Дата покупки: _____

Место покупки: _____

Вначале о главном

Благодарим вас за то, что для решения своих мобильных вычислительных задач вы выбрали ноутбук Acer.

Ваши руководства

Мы разработали ряд руководств, которые помогут вам в использовании ноутбука Acer:

Во-первых, **установочный плакат** поможет вам выполнить первоначальную настройку компьютера.

Типовое руководство для серии TravelMate содержит полезную информацию, применимую ко всем моделям серии TravelMate. В нем описываются основные темы, такие как работа с клавиатурой, звуком и т.д. Пожалуйста, имейте в виду, что упомянутое ниже **Руководство пользователя AcerSystem** является обобщенным, поэтому в нем иногда будут описываться функции или свойства, реализованные не в купленной вами модели, а лишь в определенных моделях этой серии. В таких случаях в тексте имеется пометка "только для определенных моделей".

Данное **Краткое руководство** знакомит вас с основными характеристиками и функциями вашего нового компьютера. Чтобы узнать больше о том, как повысить продуктивность вашей работы с помощью компьютера, вы можете обратиться к **AcerSystem User Guide**. Это руководство содержит подробную информацию о системных функциях, восстановлении данных, возможностях расширения и устранении неисправностей. Кроме того, оно содержит гарантийную информацию, а также общие предписания и правила безопасности при работе с вашим ноутбуком. Руководство предоставляется в виде файла PDF, изначально загруженного в компьютер. Для доступа к нему выполните следующее:

- 1 Нажмите кнопку **Пуск** > , затем > **Все программы, затем AcerSystem**.
- 2 Щелкните **AcerSystem User Guide**.



.....

Примечание. Для просмотра этого файла требуется программа Adobe Reader. Если программа Adobe Acrobat Reader не установлена на Вашем компьютере, щелчок мышью по **AcerSystem User Guide** запустит сперва установку программы Acrobat Reader. Для завершения установки выполните отображаемые на экране инструкции. За инструкциями о том, как пользоваться программой Adobe Acrobat Reader, обратитесь к меню **Справка** и поддержка.

Знакомство с ноутбуком Acer

Теперь, когда вы выполнили настройки, как показано на плакате **Для пользователей-новичков...**, давайте поближе познакомимся с вашим новым ноутбуком Acer.

Вид сверху

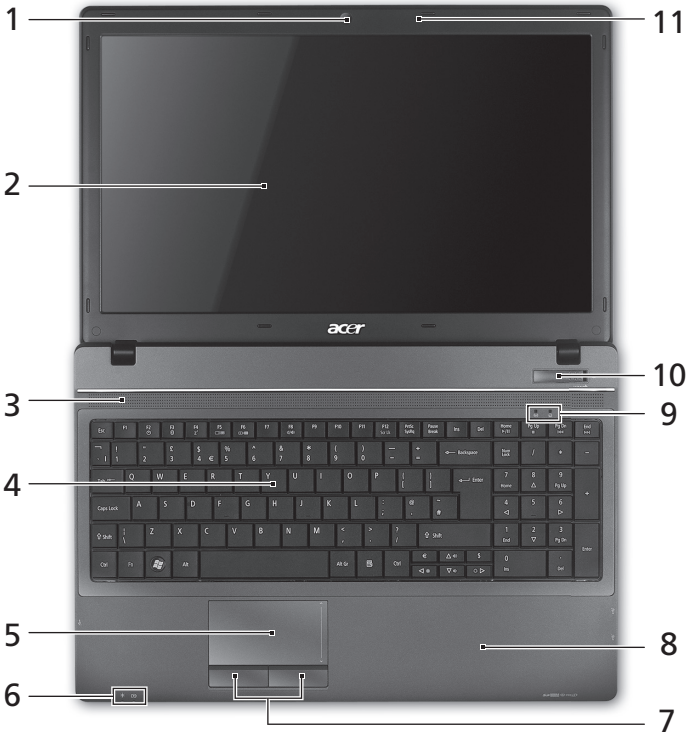

#	Значок	Элемент	Описание
1		Веб-камера Acer Crystal Eye	Веб-камера для видеосвязи (только для определенных моделей).
2		Экран дисплея	Другое название - жидкокристаллический дисплей (ЖК-дисплей); служит для вывода изображения, формируемого компьютером (конфигурация может отличаться в зависимости от модели).
3		Динамики	Передний левый и передний правый динамики служат для вывода стереозвука.
4		Клавиатура	Служит для ввода данных в компьютер.
5		Сенсорная панель	Чувствительное к прикосновениям указательное устройство, позволяющее управлять курсором на экране так же, как и мышью.
6		Индикатор питания ¹	Отображает состояние питания компьютера.
		Индикатор аккумулятора ¹	Отображает состояние аккумулятора компьютера. 1. Зарядка: Этот индикатор горит желтым во время зарядки аккумулятора. 2. Полностью заряжен: Этот индикатор горит синим при питании от электросети.
7		Кнопки управления (левая и правая)	Эти левая и правая кнопки действуют так же, как левая и правая кнопки мыши.
8		Подставка для запястий	Упорная площадка, на которую удобно положить руки при работе на компьютере.
9		Жесткий диск	Горит при обращении к жесткому диску.
		Индикатор связи	Отображает состояние модуля беспроводной связи компьютера.
10		Выключатель питания	Служит для включения/выключения компьютера.
11		Микрофон	Внутренний микрофон для записи звука.

1. Индикаторы на передней панели видны даже при закрытой крышке компьютера.

Клавишные комбинации



В компьютере используются "горячие" клавиши (комбинации клавиш) для быстрого вызова большинства функций управления компьютером, таких как яркость экрана и громкость.

Для использования клавишной комбинации сначала нажмите клавишу **<Fn>** и затем, не отпуская ее, нажмите вторую клавишу этой комбинации.

Клавишная комбинация	Значок	Функция	Описание
<Fn> + <F3>		Связь	Включение/выключение модулей связи в компьютере. (Тип модуля связи зависит от конфигурации системы.)
<Fn> + <F4>		Режим сна	Переводит компьютер в режим Сон.
<Fn> + <F5>		Переключение видеовыхода	Переключает вывод изображения либо на дисплей, либо на внешний монитор (если он подключен), либо одновременно и на дисплей, и на внешний монитор.
<Fn> + <F6>		Выкл. дисплей	Выключает экран дисплея для экономии заряда аккумулятора. Для включения экрана нажмите любую клавишу.
<Fn> + <F7>		Переключатель сенсорной панели	Включение/выключение сенсорной панели.
<Fn> + <F8>		Выключатель динамиков	Попеременно включает и выключает динамики.
<Fn> + <Δ>		Увеличение уровня громкости	Повышает громкость звука.
<Fn> + <▽>		Уменьшение уровня громкости	Уменьшает громкость звука.
<Fn> + <▷>		Повышение яркости	Повышает яркость экрана.
<Fn> + <◁>		Понижение яркости	Уменьшает яркость экрана.

Вид спереди с закрытой крышкой



#	Значок	Элемент	Описание
1		Индикатор питания ¹	Отображает состояние питания компьютера.
		Индикатор аккумулятора ¹	Отображает состояние аккумулятора компьютера. 1. Зарядка: Этот индикатор горит желтым во время зарядки аккумулятора. 2. Полностью заряжен: Этот индикатор горит синим при питании от электросети.
2		Комбинированное устройство считывания карт памяти различных форматов	Поддерживает форматы Secure Digital (SD), MultiMediaCard (MMC), Memory Stick (MS), Memory Stick PRO (MS PRO) и xD-Picture Card (xD). Примечание. Надавите, чтобы извлечь/вставить карту. Одновременно можно использовать только одну карту памяти.

Вид сзади



#	Значок	Элемент	Описание
1		Аккумулятор	Обеспечивает электропитание для компьютера, когда он используется отключенным от электросети.

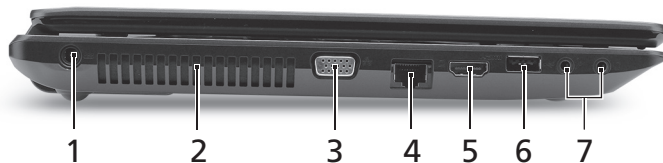

Вид слева



#	Значок	Элемент	Описание
1		Разъем для подключения питания постоянного тока	Служит для подключения адаптера переменного тока.
2		Вентиляционные отверстия	Позволяют компьютеру не перегреваться даже при длительной работе.
3		Разъем внешнего дисплея (VGA)	Служит для подключения устройства отображения (например, внешнего монитора, ЖК-проектора).
4		Разъем Ethernet (RJ-45)	Служит для подключения к сети Ethernet 10/100/1000 Мбит/с.
5		Разъем HDMI	Служит для подключения к источникам цифрового видео высокой четкости.
6		Разъем USB 2.0	Служит для подключения устройств с интерфейсом USB 2.0 (например, мыши или камеры).
7		Гнездо микрофонного входа	Служит для подключения внешнего микрофона.
		Гнездо наушников/динамика/линейный выход	Служит для подключения звуковых устройств к линейному выходу (например, динамиков, наушников).

Вид справа



#	Значок	Элемент	Описание
1		Разъем USB 2.0	Служит для подключения устройств с интерфейсом USB 2.0 (например, мыши или камеры).
2		Оптический привод	Внутренний привод оптических дисков рассчитан на использование компакт-дисков или DVD-дисков.
3		Индикатор обращения к оптическому диску	Горит во время работы привода оптических дисков.
4		Кнопка извлечения диска из привода	Служит для извлечения оптического диска из привода.
5		Отверстие аварийного извлечения	Служит для открытия лотка привода оптических дисков, когда питание компьютера отключено. Примечание. Чтобы открыть лоток привода оптических дисков, когда компьютер выключен, вставьте в это отверстие аварийного извлечения разогнутую скрепку.
6		Замок типа Kensington	Служит для подсоединения защитного тросика с замком типа Kensington для предотвращения кражи компьютера. Примечание. Этим защитным тросиком обвяжите какой-нибудь неподвижный предмет, например, стол или ручку запертого ящика. Вставьте замок тросика в гнездо и поверните ключ, чтобы запереть замок. Бывают модели замков и без ключей.

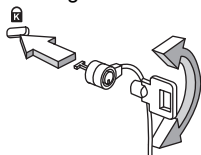

Вид снизу

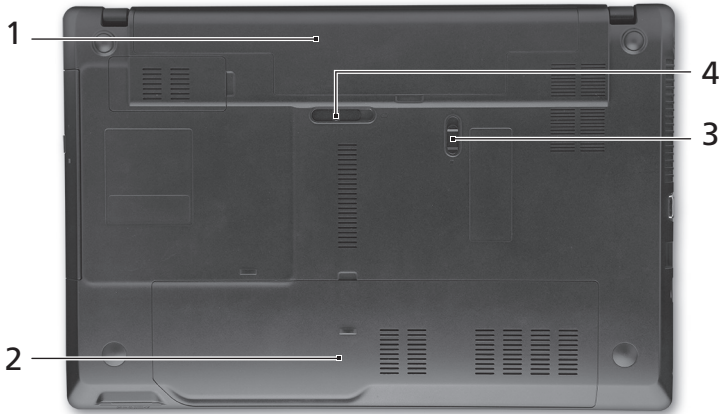

#	Значок	Элемент	Описание
1		Отсек аккумулятора	В этот отсек устанавливается аккумулятор компьютера.
2		Отсек жесткого диска	Здесь размещается жесткий диск компьютера (крепится винтами).
		Отсек модулей оперативной памяти	В этот отсек устанавливаются модули оперативной памяти компьютера.
3		Защелка аккумулятора	Служит для фиксации аккумулятора в отсеке.
4		Защелка извлечения аккумулятора	Разблокирует аккумулятор для его извлечения.

Условия эксплуатации

- Температура:
 - Рабочая: от 5°C до 35°C
 - Нерабочая: от -20°C до 65°C
- Влажность (без конденсации):
 - Рабочая: от 20% до 80%
 - Нерабочая: от -20% до 80%

Komputer serii TravelMate 5740/5740Z/5340

Skrócony poradnik

© 2010 Wszelkie prawa zastrzeżone.

Skrócony poradnik komputera serii TravelMate 5740/5740Z/5340

Wydanie oryginalne: 03/2010

Notebook PC serii TravelMate 5740/5740Z/5340

Oznaczenie modelu: _____

Numer seryjny: _____

Data zakupu: _____

Miejsce zakupu: _____

Po kolei

Dziękujemy za wybranie komputera firmy Acer do spełnienia potrzeb w zakresie mobilnego przetwarzania.

Instrukcje

Aby pomóc w korzystaniu z notebooka Acer, opracowaliśmy zestaw instrukcji:

Jako pierwszy **plakat instalacyjny** pomoże użytkownikom rozpocząć ustawianie komputera.

Ogólny podręcznik użytkownika urządzenia serii TravelMate zawiera przydatne informacje dotyczące wszystkich modeli serii TravelMate. Obejmuje podstawowe zagadnienia, takie jak używanie klawiatury, dźwięki itd. Należy pamiętać, że **Podręcznik użytkownika AcerSystem**, o którym mowa poniżej, odnosi się czasami do funkcji lub elementów tylko niektórych modeli serii, które nie muszą występować w zakupionym modelu. Przypadki takie są oznaczone w tekście dopiskiem „w wybranych modelach”.

Skrócony poradnik przedstawia podstawowe właściwości i funkcje nowego komputera. Aby uzyskać więcej informacji o tym, w jaki sposób nowy komputer może pomóc Ci być bardziej produktywnym, zapoznaj się z **AcerSystem User's Guide**. Przewodnik ten zawiera szczegółowe informacje dotyczące takich tematów, jak narzędzia systemowe, odzyskiwanie danych, opcje rozszerzeń oraz rozwiązywanie problemów. Oprócz nich zawiera także informacje na temat gwarancji oraz informacje dotyczące bezpieczeństwa pracy z Twoim komputerem przenośnym. Jest on dostępny w formie elektronicznej jako plik PDF zapisany fabrycznie na dysku komputera. Wykonaj poniższe czynności, aby uzyskać do niego dostęp:

- 1 Kliknij **Start** > **Wszystkie programy** > **AcerSystem**.
- 2 Kliknij **AcerSystem User's Guide**.



.....





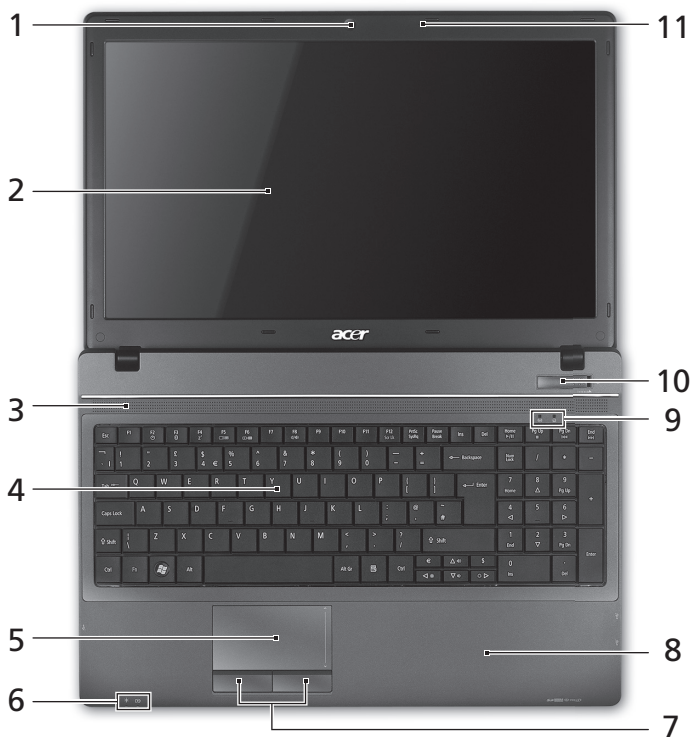

Uwaga: Aby można było przeglądać ten plik, konieczne jest zainstalowanie programu Adobe Reader. Jeżeli w komputerze nie zainstalowano programu Adobe Reader, kliknięcie **AcerSystem User's Guide** spowoduje uruchomienie instalatora programu Adobe Reader. Aby zakończyć instalację, należy postępować zgodnie z instrukcjami wyświetlanymi na ekranie. Instrukcje dotyczące używania programu Adobe Reader, znajdują się w menu **Pomocy i obsługi technicznej**.

Zapoznanie z notebookiem Acer

Po ustawieniu komputera jak to przedstawiono na ilustracji na plakacie **Dla początkujących...**, zapoznaj się bliżej z notebookiem Acer.

Widok z góry











#	Ikona	Element	Opis
1		Kamera Acer Crystal Eye	Kamera internetowa do komunikacji wideo (w wybranych modelach).
2		Ekran wyświetlacz	Nazywany jest także wyświetlaczem ciekłokrystalicznym (Liquid-Crystal Display; LCD), wyświetla informacje wyjściowe komputera (Konfiguracja może być różna w zależności od modelu).
3		Głośniki	Przedni lewy i przedni prawy głośnik zapewniają możliwość słuchania stereofonicznego dźwięku.
4		Klawiatura	Umożliwia wprowadzanie danych do komputera.
5		Touchpad	Dotykowe urządzenie wskazujące, które działa jak myszka komputerowa.
6		Wskaźnik zasilania ¹	Wskazuje stan zasilania komputera.
		Wskaźnik akumulatora ¹	Wskazuje stan akumulatora komputera. 1. Ładowanie: Świeci żółtym światłem, gdy akumulator jest ładowany. 2. Pełne naładowanie: Świeci niebieskim światłem podczas pracy w trybie zasilania prądem przemiennym.
7		Przyciski klikania (lewy i prawy)	Działanie lewego i prawego przycisku jest podobne do działania lewego i prawego przycisku myszki.
8		Podparcie nadgarstków	Wygodne podparcie dłoni podczas używania komputera.
9		Twardy dysk	Świeci, gdy działa dysk twardy.
		Wskaźnik komunikacji	Wskazuje stan połączenia bezprzewodowego komputera z urządzeniem.
10		Włącznik zasilania	Służy do włączania i wyłączania komputera.
11		Mikrofon	Wewnętrzny mikrofon do rejestrowania dźwięku.

1. Wskaźniki panelu czołowego są widoczne nawet po zamknięciu pokrywy komputera.

Klawisze skrótów



Komputer umożliwia używanie klawiszy skrótów lub kombinacji klawiszy w celu uzyskania dostępu do większości kontrolowanych parametrów, takich jak jasność ekranu czy ustawienia głośności.

Aby uaktywnić klawisze skrótów, naciśnij i przytrzymaj klawisz **<Fn>** przed naciśnięciem innego klawisza w kombinacji klawisza skrótu.

Klawisz skrótu	Ikona	Funkcja	Opis
<Fn> + <F3>		Komunikacja	Włącza/wyłącza urządzenia komunikacyjne komputera. (Urządzenia komunikacyjne mogą być różne w zależności od konfiguracji.)
<Fn> + <F4>		Wstrzymanie	Powoduje przejście komputera do trybu Wstrzymanie.
<Fn> + <F5>		Przełączenie wyświetlania	Umożliwia przełączanie sygnału wyjściowego wyświetlacza na ekran wyświetlacza lub na zewnętrzny monitor (jeśli jest przyłączony) lub na oba.
<Fn> + <F6>		Wyłączenie ekranu	Wyłącza podświetlenie ekranu wyświetlacza w celu oszczędzania energii. Naciśnij dowolny klawisz w celu przywrócenia wyświetlania.
<Fn> + <F7>		Przełączenie touchpada	Służy do włączania i wyłączenia touchpada.
<Fn> + <F8>		Przełączenie głośnika	Umożliwia włączanie i wyłączenie głośników.
<Fn> + <▲>		Zwiększenie głośności	Zwiększa głośność dźwięku.
<Fn> + <▼>		Zmniejszenie głośności	Zmniejsza głośność dźwięku.
<Fn> + <▶>		Zwiększenie jasności	Zwiększa jasność ekranu.
<Fn> + <◀>		Zmniejszenie jasności	Zmniejsza jasność ekranu.

Widok z przodu (pokrywa zamknięta)



#	Ikona	Element	Opis
1		Wskaźnik zasilania ¹	Wskazuje stan zasilania komputera.
		Wskaźnik akumulatora ¹	Wskazuje stan akumulatora komputera. 1. Ładowanie: Świeci żółtym światłem, gdy akumulator jest ładowany. 2. Pełne naładowanie: Świeci niebieskim światłem podczas pracy w trybie zasilania prądem przemiennym.
2		Wielofunkcyjny czytnik kart pamięci	Obsługuje następujące typy kart: Secure Digital (SD), MultiMediaCard (MMC), Memory Stick (MS), Memory Stick PRO (MS PRO) oraz xD-Picture Card (xD). Uwaga: Aby wyjąć/zainstalować kartę, wciśnij ją delikatnie. Jednorazowo można obsługiwać tylko jedną kartę.







Widok z tyłu

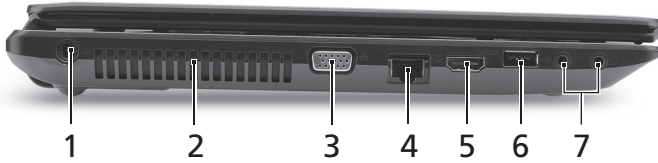

#	Ikona	Element	Opis
1		Akumulator	Zapewnia zasilanie komputera, kiedy nie jest on podłączony do sieci elektrycznej.



Widok z lewej



#	Ikona	Element	Opis
1		Gniazdo zasilania	Gniazdo zasilacza.
2		Szczeliny wentylacyjne	Umożliwiają chłodzenie komputera nawet podczas długotrwałego użytkowania.
3		Port zewnętrznego wyświetlacza (VGA)	Służy do przyłączania urządzenia wyświetlającego (np. zewnętrzny monitor, projektor LCD).
4		Port Ethernet (RJ-45)	Służy do przyłączania do sieci komputerowej typu Ethernet 10/100/1000.
5		Port HDMI	Obsługuje połączenie cyfrowego wideo o wysokiej rozdzielczości.
6		Port USB 2.0	Służy do podłączania urządzeń USB 2.0 (np. mysz USB lub kamera USB).
7		Gniazdo mikrofonowe	Służy do przyłączania sygnału z zewnętrznych mikrofonów.
		Gniazdo słuchawki/ głośniki/wyjścia liniowego	Służy do przyłączania urządzeń liniowego wyjścia audio (np. głośniki, słuchawki).

Widok z prawej



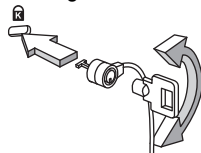

#	Ikona	Element	Opis
1		Port USB 2.0	Służy do przyłączania urządzeń USB 2.0 (np. mysz USB, aparat cyfrowy USB).
2		Napęd optyczny	Wewnętrzny napęd optyczny; obsługuje dyski CD lub DVD.
3		Wskaźnik dostępu do dysku optycznego	Świeci, kiedy napęd optyczny jest aktywny.
4		Przycisk wysuwania napędu optycznego	Wyrzuca dysk optyczny z napędu.
5		Otwór wysuwania awaryjnego	Umożliwia wysunięcie tacy napędu optycznego, kiedy komputer jest wyłączony. Uwaga: Wsuń spinacz do otworu wysuwania awaryjnego w celu wysunięcia tacy napędu optycznego, kiedy komputer jest wyłączony.
6		Gniazdo blokady Kensington	Służy do podłączania blokady zgodnej ze standardem firmy Kensington. Uwaga: Kabel zabezpieczenia komputera należy owinąć wokół ciężkiego nieruchomego obiektu, takiego jak stół lub uchwyt zablokowanej szuflady. Wstaw zamek blokady do gniazda i przekręć klucz w celu zamknięcia blokady. Dostępne są także modele bez kluczy.

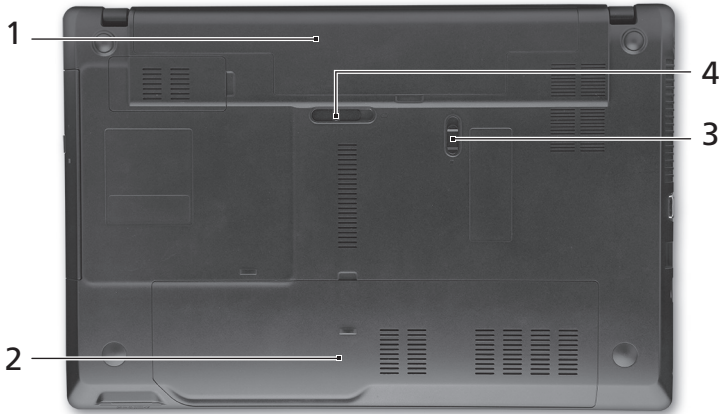

Widok od strony podstawy



#	Ikona	Element	Opis
1		Wnęka na baterię	Przechowuje baterię komputera.
2		Wnęka na dysk twardy	Mieści dysk twardy komputera (zabezpieczona śrubami).
		Przegroda na pamięć	Mieści główną pamięć komputera.
3		Zatrzaszk baterii	Pozwala zabezpieczyć baterię w prawidłowej pozycji.
4		Blokada baterii	Umożliwia zwolnienie i wyjęcie baterii.

Warunki środowiska

- Temperatura:
 - Podczas pracy: Od 5°C do 35°C
 - Podczas przechowywania: Od -20°C do 65°C
- Wilgotność (bez kondensacji pary):
 - Podczas pracy: Od 20% do 80%
 - Podczas przechowywania: Od 20% do 80%

TravelMate 5740/5740Z/5340 sorozat

Rövid útmutató

© 2010 Minden jog fenntartva.

TravelMate 5740/5740Z/5340 sorozat Rövid útmutató
Eredeti kiadás: 03/2010

TravelMate 5740/5740Z/5340 sorozatú hordozható számítógép

Modellszám: _____

Sorozatszám: _____

Vásárlás időpontja: _____

Vásárlás helye: _____

Az első lépések

Köszönjük, hogy mobil számítástechnikai feladatai elvégzéséhez egy Acer hordozható számítógépet választott.

Útmutatók

Minden segítséget szeretnénk megadni Önnek új Acer gépének használatához, ezért a következő útmutatókat dolgoztuk ki:

Első lépésként a **telepítési poszteren** szereplő útmutatást követve helyezze üzembe a számítógépet.

A **TravelMate sorozat általános felhasználói útmutatója** a TravelMate terméksorozat összes tagjára vonatkozó hasznos tudnivalókat tartalmaz. Olyan általános témaköröket tárgyal, mint a billentyűzet használata, a hangok stb. Felhívjuk figyelmét arra, hogy jellegéből fakadóan az alább említett **AcerSystem User Guide** egyes esetekben olyan funkcióra vagy szolgáltatásra is hivatkozhat, amely a terméksorozatnak csak bizonyos tagjain érhető el, és amelyet az Ön által megvásárolt típus nem támogat. Az ilyen eseteket a szövegben a „csak bizonyos modellek esetében” vagy hasonló megjegyzés jelöli.

A jelen **Rövid útmutató** ismerteti az Ön új számítógépének alapvető jellemzőit és funkciót. A számítógép még hatékonyabb használatával kapcsolatban az **AcerSystem User Guide** tartalmaz útmutatást. Ez a kézikönyv részletes információkat tartalmaz például az előre telepített segédprogramokról, az adathelyreállításról, a bővítési lehetőségekről és a hibaelhárításról. Emellett ismerteti a garanciával kapcsolatos tudnivalókat, valamint a számítógépre vonatkozó általános szabályokat és biztonsági előírásokat. A kézikönyv Portable Document Format (PDF) formátumú, és gyárilag telepítve van a számítógépre. Megnyitásához kövesse az alábbi lépéseket:

- 1 Kattintson a következő elemekre: **Start > Minden program > AcerSystem**.
- 2 Kattintson az **AcerSystem User Guide** elemre.



.....





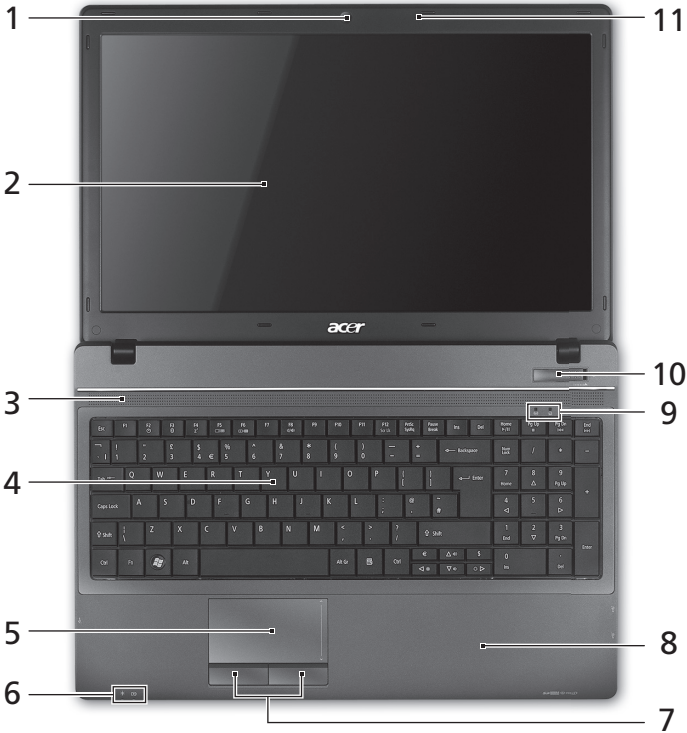

Megjegyzés: A fájl megtekintéséhez szükség van az Adobe Reader alkalmazásra. Ha az Adobe Reader nincs telepítve a számítógépre, akkor az **AcerSystem User Guide** elemre kattintva először az Adobe Reader telepítőprogramja jelenik meg. A telepítés elvégzéséhez kövesse a képernyőn megjelenő utasításokat. Az Adobe Reader használatával kapcsolatban a **Súgó és támogatás** menüben talál útmutatást.

Ismerkedjen meg új Acer gépével!

Miután a **Kezdők számára...** poszter alapján üzembe helyezte a számítógépet, ismerkedjen meg új Acer notebookjával!

Felülnézet













#	Ikon	Elem	Leírás
1		Acer Crystal Eye webkamera	Webkamera videokommunikációs célokra (csak bizonyos típusok esetében).
2		Kijelző	Más néven folyadékkristályos kijelző (Liquid-Crystal Display, LCD), a számítógép kimenetét jeleníti meg (A konfiguráció típustól függően változhat).
3		Hangszórók	A bal első és a jobb első hangszóró a hangok sztereó megszólaltatását teszi lehetővé.
4		Billentyűzet	Az adatbevitel eszköze.
5		Érintőpad	Érintésérzékeny mutatóeszköz, a számítógépek egeréhez hasonlóan működik.
6		Üzemállapot jelzőfénye ¹	A számítógép üzemállapotát jelzi.
		Akkumulátor állapotjelzője ¹	Az akkumulátor üzemállapotát jelzi. 1. Töltés: Sárgán világít, ha az akkumulátor töltése folyamatban van. 2. Teljesen feltöltve: Hálózati tápellátás használatakor kéken világít.
7		Kattintógombok (bal és jobb)	A bal és a jobb gomb az egér bal és jobb gombjához hasonlóan működik.
8		Csulótámasz	Kényelmes támaszkodási felület a számítógép használatának idejére.
9		HDD	Jelzi, ha a merevlemez használatban van.
		Kommunikáció jelző	A számítógép vezeték nélküli kommunikációs egységének állapotát jelzi.
10		Bekapcsoló gomb	A számítógép be- és kikapcsolására szolgál.
11		Mikrofon	Belső mikrofon hangfelvételek készítéséhez.

1. Az előlap jelzői akkor is láthatók, ha a számítógép fedele le van hajtva.

Gyorsbillentyűk

A számítógép a legtöbb beállítás elérését gyorsbillentyűkkel vagy billentyűkombinációkkal teszi lehetővé; ilyen például a képernyő fényereje és a hangerő.

Gyorsbillentyű használatához nyomja le és tartsa lenyomva az **<Fn>** billentyűt, a billentyűkombináció másik billentyűjét csak ezt követően nyomja le.

Gyorsbillentyű	Ikon	Funkció	Leírás
<Fn> + <F3>		Kommunikáció	A számítógép kommunikációs moduljainak be- és kikapcsolására használható. (A kommunikációs modulok konfigurációtól függően eltérők lehetnek.)
<Fn> + <F4>		Alvás	Alvó üzemmódba helyezi a számítógépet.
<Fn> + <F5>		A kijelző átkapcsolása	Váltás a következő megjelenítési módok között: kijelző, külső monitor (ha csatlakoztatva van), illetve mindkettő.
<Fn> + <F6>		A kijelző kikapcsolása	A kijelző háttérvilágításának kikapcsolása energiamegtakarítás céljából. A háttérvilágítás bármely billentyű megnyomására visszakapcsol.
<Fn> + <F7>		Érintőpad be- és kikapcsolása	Az érintőpad be- és kikapcsolását teszi lehetővé.
<Fn> + <F8>		Hangszóró be- és kikapcsolása	A hangszórók be- és kikapcsolását teszi lehetővé.
<Fn> + <Δ>		A hangerő növelése	Növeli a hangerőt.
<Fn> + <▽>		A hangerő csökkentése	Csökkenti a hangerőt.
<Fn> + <▷>		Fényerő növelése	Növeli a kijelző fényerejét.
<Fn> + <◁>		Fényerő csökkentése	Csökkenti a kijelző fényerejét.

Előnézet lehajtott kijelzővel



#	Ikon	Elem	Leírás
1		Üzemállapot jelzőfénye ¹	A számítógép üzemállapotát jelzi.
		Akkumulátor állapotjelzője ¹	Az akkumulátor üzemállapotát jelzi. 1. Töltés: Sárgán világít, ha az akkumulátor töltése folyamatban van. 2. Teljesen feltöltve: Hálózati tápellátás használatakor kéken világít.
2		Multifunkciós kártyaolvasó	Secure Digital (SD), MultiMediaCard (MMC), Memory Stick (MS), Memory Stick PRO (MS PRO) és xD-Picture Card (xD) kártyák fogadására képes. Megjegyzés: A kártyák finoman benyomva helyezhetők be és vehetők ki. Egyszerre csak egyféle kártya használatára van lehetőség.







Hátulnézet

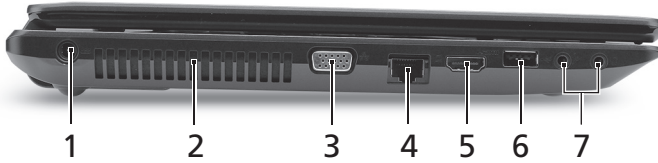

#	Ikon	Elem	Leírás
1		Akkumulátor	A számítógép energiaellátását biztosítja, amikor az nincs csatlakoztatva az elektromos hálózatra.



Bal oldali nézet



#	Ikon	Elem	Leírás
1		Egyenáramú bemeneti aljzat	A váltakozó áramú hálózati adapter csatlakoztatását teszi lehetővé.
2		Szellőzőnyílások	Segítségükkel még hosszasan is fenntartható a számítógép megfelelő üzemi hőmérséklete.
3		Külső kijelző (VGA) port	Megjelenítő eszköz (pl. külső monitor vagy LCD kivetítő) csatlakoztatását teszi lehetővé.
4		Ethernet (RJ-45) port	Ethernet 10/100/1000 típusú hálózattal képes biztosítani a kapcsolatot.
5		HDMI port	A nagy felbontású, digitális videokapcsolatokat támogatja.
6		USB 2.0 port	USB 2.0 eszközök (pl. USB-s egér vagy kamera) csatlakoztatását teszi lehetővé.
7		Mikrofonbemeneti aljzat	Külső mikrofon csatlakoztatását teszi lehetővé.
		Fejhallgató/hangszóró/vonali kimenet aljzat	Hangkimeneti eszközök (pl. hangszóró, fejhallgató) csatlakoztatására alkalmas.

Jobb oldali nézet





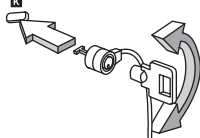

#	Ikon	Elem	Leírás
1		USB 2.0 port	USB 2.0 eszközök (pl. USB-s egér vagy kamera) csatlakoztatását teszi lehetővé.
2		Optikai meghajtó	Belső optikai meghajtó, CD- és DVD-lemezek kezelésére képes.
3		Az optikai lemez elérését jelző fény	Akkor világít, amikor az optikai meghajtó aktív.
4		Optikai meghajtó kiadógombja	Kiadatja a lemezt az optikai meghajtóból.
5		Vészkiadó furat	Lehetővé teszi az optikai meghajtó tálcájának a számítógép kikapcsolt állapotában történő kinyitását. Megjegyzés: Az optikai meghajtó lemeztálcájának kinyitásához helyezzen egy papírcapcsot a vészkiadó nyílásba, miközben a számítógép ki van kapcsolva.
6		Kensington záraljzat	Kensington számítógépes biztonsági zár alkalmazását teszi lehetővé. Megjegyzés: Hurkolja a számítógépes biztonsági zárhoz tartozó drótkötelet egy mozdíthatatlan tárgy, például asztal vagy zárt fiók fogantyúja köré. Illessze be a horonyba a zárat, majd a kulcsot elfordítva rögzítse. Kaphatók kulcs nélküli modellek is.

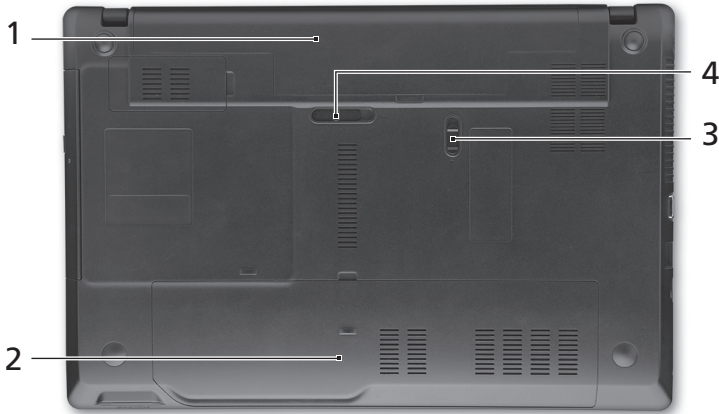

Alulnézet



#	Ikon	Elem	Leírás
1		Akkumulátorfoglalat	A számítógép akkumulátorát fogadja be.
2		Merevlemez-foglalat	A számítógép merevlemezét fogadja be (csavaros rögzítésű).
		Memóriarekesz	A számítógép memóriáját fogadja be.
3		Akkumulátor retesze	Az akkumulátor rögzítését biztosítja.
4		Akkumulátor kioldógombja	Az akkumulátor eltávolítását teszi lehetővé.

Környezet

- Hőmérséklet:
 - Üzemeltetés: 5°C – 35°C
 - Kikapcsolt állapotban: -20°C – 65°C
- Páratartalom (kicsapódás nélkül):
 - Üzemeltetés: 20% – 80%
 - Kikapcsolt állapotban: 20% – 80%

Řada TravelMate 5740/ 5740Z/5340

Stručné pokyny

© 2010 Všechna práva vyhrazena.

Stručné pokyny pro počítače řady TravelMate 5740/5740Z/5340

Původní vydání: 03/2010

Notebook řady TravelMate 5740/5740Z/5340

Číslo modelu: _____

Sériové číslo: _____

Datum zakoupení: _____

Místo zakoupení: _____

Stručné pokyny

Děkujeme vám, že jste si k uspokojení svých potřeb v oblasti přenosných počítačů vybrali notebook Acer.

Uživatelské příručky

Abychom vám při používání notebooku Acer pomohli, vytvořili jsme pro vás sadu příruček:

Instalační leták vám pomůže při úvodním nastavení počítače.

Obecná uživatelská příručka pro počítače TravelMate obsahuje užitečné informace pro všechny modely řady TravelMate. Obsahuje základní témata, např. používání klávesnice a zvuku atd. Berte laskavě na vědomí, že níže zmíněná **AcerSystem User Guide** může popisovat funkce nebo vlastnosti, kterými jsou vybaveny pouze určité modely dané řady a kterými nemusí být nutně vybaven vámi zakoupený model. V takových případech je text označen frází „pouze u vybraných modelů“.

Tyto **Stručné pokyny** vás seznámí se základními schopnostmi a funkcemi nového počítače. Další informace o tom, jak můžete pomocí počítače zvýšit svou produktivitu, naleznete v příručce **AcerSystem User's Guide**. Tato příručka obsahuje podrobné informace týkající se například systémových nástrojů, obnovování dat, možností rozšíření a odstraňování potíží. Dále obsahuje záruční informace, informace týkající se všeobecných předpisů a bezpečnostní upozornění k notebooku. Příručka je k dispozici ve formátu PDF (Portable Document Format) a je již uložena do notebooku. Zobrazíte ji následujícím postupem:

- 1 Klepněte na tlačítko **Start > Všechny programy > AcerSystem**.
- 2 Klepněte na položku **AcerSystem User's Guide**.







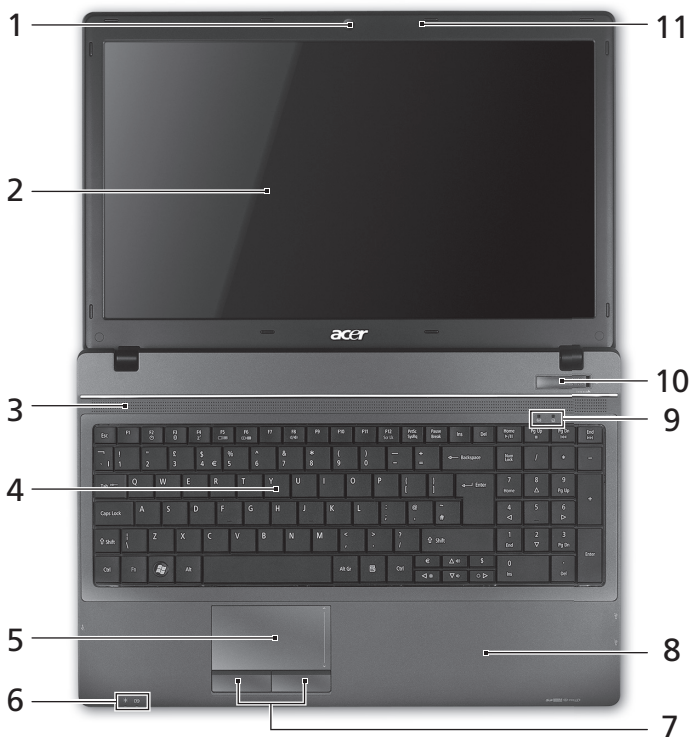

Poznámka: K zobrazení tohoto souboru je vyžadován program Adobe Reader. Pokud v počítači není program Adobe Reader nainstalován, klepnutím na položku **AcerSystem User Guide** nejprve spustíte instalační program. Dokončete instalaci podle pokynů na obrazovce. Pokyny týkající se používání programu Adobe Reader jsou k dispozici v nabídce **Nápověda a odborná pomoc**.

Seznámení s notebookem Acer

Po nastavení počítače podle pokynů znázorněných na letáku **První kroky...** vás seznámíme s vaším novým notebookem Acer.

Pohled shora













#	Ikona	Položka	Popis
1		Webová kamera Acer Crystal Eye	Webová kamera pro obrazovou komunikaci (pouze u vybraných modelů).
2		Displej	Na displeji, označovaném také displej z tekutých krystalů (Liquid-Crystal Display; LCD), se zobrazuje grafický výstup počítače (Konfigurace se může lišit podle modelů).
3		Reproduktory	Levý přední a pravý přední reproduktor zajišťují stereofonní zvukový výstup.
4		Klávesnice	Slouží k zadávání údajů do počítače.
5		Touchpad	Polohovací zařízení citlivé na dotek, které má podobnou funkci jako počítačová myš.
6		Indikátor napájení ¹	Indikuje stav napájení počítače.
		Indikátor baterie ¹	Indikuje stav baterie počítače. 1. Nabíjení: Při nabíjení baterie svítí indikátor jantarově. 2. Plné nabití: V režimu napájení ze sítě svítí indikátor modře.
7		Indikátor napájení (levé a pravé)	Levé a pravé tlačítko funguje jako levé a pravé tlačítko myši.
8		Podložka ruky	Oblast k pohodlnému opření rukou při používání počítače.
9		HDD	Svítí, pokud je aktivní pevný disk.
		Indikátor komunikace	Indikuje stav zařízení pro bezdrátové připojení počítače.
10		Vypínač napájení	Slouží k zapnutí a vypnutí počítače.
11		Mikrofon	Interní mikrofon pro nahrávání zvuku.

1. Stavové indikátory na předním panelu jsou viditelné i po zavření víka počítače.

Klávesové zkratky



Tento počítač využívá klávesové zkratky nebo kombinace kláves ke zpřístupnění většiny ovládacích prvků počítače, jako je jas zobrazení a hlasitost výstupu.

Klávesovou zkratku aktivujete stisknutím a podržením klávesy **<Fn>** dříve, než stisknete druhou klávesu této kombinace.

Klávesová zkratka	Ikona	Funkce	Popis
<Fn> + <F3>		Komunikace	Povoluje/zakazuje komunikační zařízení počítače. (Komunikační zařízení mohou mít různou konfiguraci.)
<Fn> + <F4>		Režim spánku	Slouží k přepnutí počítače do režimu spánku.
<Fn> + <F5>		Přepnutí displeje	Přepíná výstup zobrazení mezi displejem, externím monitorem (pokud je připojen) a oběma zařízeními.
<Fn> + <F6>		Vypnout displej	Slouží k vypnutí podsvícení obrazovky displeje, čímž se ušetří energie. Podsvícení obnovíte stisknutím libovolné klávesy.
<Fn> + <F7>		Přepnutí zařízení touchpad	Slouží k zapnutí a vypnutí touchpadu.
<Fn> + <F8>		Přepnutí reproduktoru	Slouží k zapnutí a vypnutí reproduktorů.
<Fn> + <Δ>		Zvýšení hlasitosti	Slouží ke zvýšení hlasitosti zvuku.
<Fn> + <▽>		Snížení hlasitosti	Slouží ke snížení hlasitosti zvuku.
<Fn> + <▷>		Zvýšení jasu	Slouží ke zvýšení jasu obrazovky.
<Fn> + <◁>		Snížení jasu	Slouží ke snížení jasu obrazovky.

Pohled na zavřenou přední stranu



#	Ikona	Položka	Popis
1		Indikátor napájení ¹	Indikuje stav napájení počítače.
		Indikátor baterie ¹	Indikuje stav baterie počítače. 1. Nabíjení: Při nabíjení baterie svítí indikátor jantarově. 2. Plné nabití: V režimu napájení ze sítě svítí indikátor modře.
2		Čtečka karet Více v 1	Podporuje karty Secure Digital (SD), MultiMediaCard (MMC), Memory Stick (MS), Memory Stick PRO (MS PRO) a xD-Picture Card (xD). Poznámka: Stisknutím vyjměte nebo vložte kartu. V jednom okamžiku lze použít jen jednu kartu.



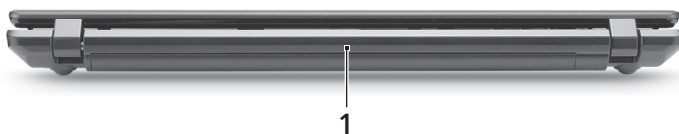



Pohled zezadu

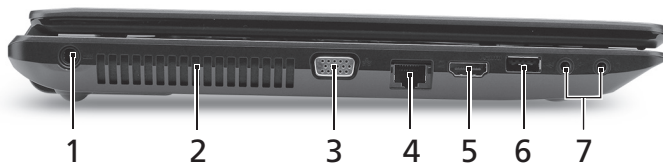

#	Ikona	Položka	Popis
1		Baterie	Zajišťuje napájení počítače, pokud jej chcete používat bez zapojení do zásuvky.



Pohled zleva



#	Ikona	Položka	Popis
1		Napájecí konektor	Zajišťuje připojení k síťovému adaptéru.
2		Ventilační otvory	Umožňují chlazení počítače i při dlouhodobém používání.
3		Port externího zobrazovacího zařízení (VGA)	Umožňuje připojení zobrazovacího zařízení (například externího monitoru nebo projektoru LCD).
4		Port Ethernet (RJ-45)	Slouží k připojení počítače k síti Ethernet 10/100/1000.
5		Port HDMI	Podporuje připojení digitálního videa ve vysokém rozlišení.
6		Port USB 2.0	Umožňuje připojení zařízení s rozhraním USB 2.0 (například myš nebo fotoaparát USB).
7		Konektor pro vstup mikrofonu	Slouží k připojení vstupů z externího mikrofonu.
		Konektor pro připojení sluchátek, reproduktorů nebo zvukového výstupu	Slouží k připojení vnějších výstupních zvukových zařízení (například reproduktorů nebo sluchátek).

Pohled zprava





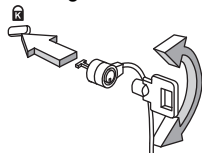

#	Ikona	Položka	Popis
1		Port USB 2.0	Umožňuje připojení zařízení s rozhraním USB 2.0 (například myš nebo fotoaparát USB).
2		Optická jednotka	Interní optická jednotka, používá disky CD a DVD.
3		Indikátor přístupu k optickému disku	Svítlí, pokud je optická jednotka aktivní.
4		Tlačítko vysunutí optické jednotky	Vysouvá optický disk z jednotky.
5		Otvor pro nouzové vysunutí	Umožňuje vysunutí přihrádky optické jednotky, pokud je počítač vypnutý. Poznámka: Chcete-li vysunout přihrádku optické jednotky, jestliže je počítač vypnutý, vložte do otvoru pro nouzové vysunutí kancelářskou sponku.
6		Drážka pro zámek Kensington	Umožňuje připojení počítačového bezpečnostního zámku kompatibilního s typem Kensington. Poznámka: Připevněte bezpečnostní kabel k nehybnému předmětu, například ke stolu nebo rukojeti uzamčené zásuvky. Vložte zámek do drážky a otočením klíče zámek zamkněte. K dispozici jsou rovněž modely bez klíče.

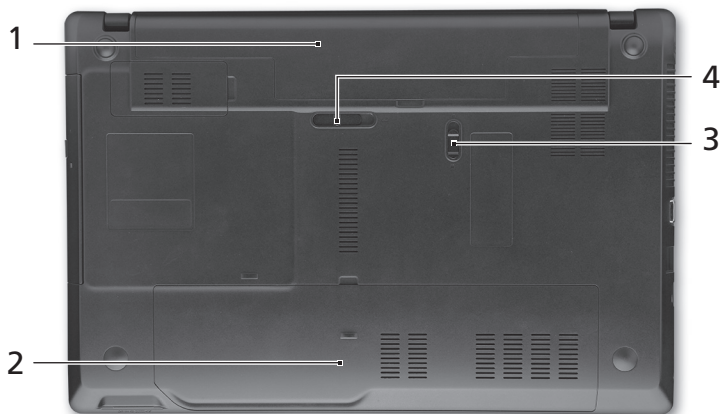

Pohled zespodu



#	Ikona	Položka	Popis
1		Pozice pro baterii	Zde je uložena baterie počítače.
2		Pozice pro pevný disk	Zde je uložen pevný disk počítače (zajištěný šroubem).
		Pozice pro paměť	Zde je uložena hlavní paměť počítače.
3		Zámek baterie	Zamkne baterii na místě.
4		Uvolňovací západka baterie	Uvolňuje baterii k vyjmutí.

Prostředí

- Teplota:
 - Provozní: 5°C až 35°C
 - Neprovozní: -20°C až 65°C
- Vlhkost (nekondenzující):
 - Provozní: 20% až 80%
 - Neprovozní: 20% až 80%

Séria TravelMate 5740/ 5740Z/5340

Stručná príručka

© 2010 Všetky práva vyhradené.

Stručná príručka pre sériu TravelMate 5740/5740Z/5340

Pôvodné vydanie: 03/2010

Prenosný počítač série TravelMate 5740/5740Z/5340

Číslo modelu: _____

Sériové číslo: _____

Dátum zakúpenia: _____

Miesto zakúpenia: _____

Hneď na úvod

Radi by sme vám poďakovali za rozvoj prenosných počítačov Acer – vašej voľby pre svoje mobilné počítačové potreby.

Vaše príručky

Aby sme vám pomohli s používaním prenosného počítača Acer, vytvorili sme pre vás set príručiek:

V prvom rade **plagát nastavenia**, ktorý vám pomôže začať s nastavením počítača.

Dokument **Všeobecná príručka pre sériu TravelMate** obsahuje užitočné informácie týkajúce sa všetkých modelov v produktovom rade TravelMate. Obsahuje základné témy, napríklad o používaní klávesnice a zvuku atď. Majte teda na pamäti, že **Používateľská príručka AcerSystem**, ktorá je spomenutá ďalej, občas obsahuje informácie o funkciách alebo vlastnostiach, ktorými sú vybavené iba určité modely produktovej série, ale model, ktorý si zakúpili, nimi nemusí byť vybavený. Opis takýchto funkcií je v texte označený poznámkou v zmysle „len pre určité modely“.

Obsahom dokumentu **Stručná príručka** sú základné funkcie a vlastnosti vášho nového počítača. Informácie o tom, ako vám počítač pomôže byť produktívnejší, nájdete v dokumente **Používateľská príručka AcerSystem**. Táto príručka obsahuje podrobné informácie o systémových programoch, oprave dát, možnostiach rozšírenia a riešenie problémov. Okrem toho obsahuje informácie o záruke a všeobecnej vyhlásenia k predpisom a bezpečnosti. Je dostupná vo formáte PDF a je umiestnená vo vašom prenosnom počítači. Ak si chcete pozrieť jej obsah, postupujte podľa nasledovných krokov:

- 1 Kliknite na **Štart > Všetky programy > AcerSystem**.
- 2 Kliknite na **AcerSystem User's Guide**.



.....





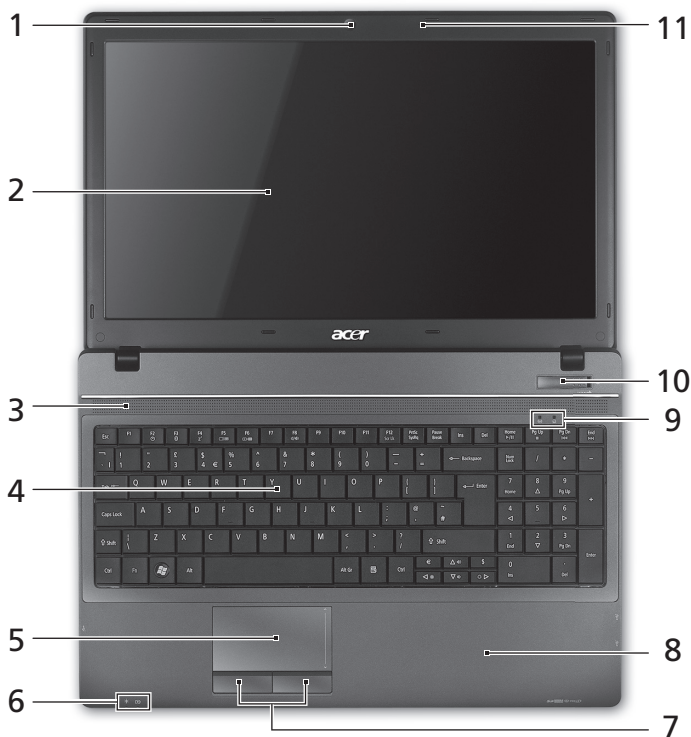

Poznámka: Prezeranie súboru vyžaduje program Adobe Reader. Ak na vašom počítači nie je program Adobe Reader nainštalovaný, kliknutím na **AcerSystem User's Guide** sa najprv spustí inštalácia programu Adobe Reader. Inštaláciu dokončíte podľa inštrukcií, ktoré uvidíte na obrazovke. Pokyny na používanie programu Adobe Reader nájdete v ponuke **Pomocník a Podpora**.

Zoznámte sa so svojím prenosným počítačom Acer

Po nastavení počítača podľa **Práve začíname...** nám dovolte, aby sme vás zoznámili s novým prenosným počítačom Acer.

Pohľad zhora













#	Ikona	Položka	Popis
1		Webkamera Acer Crystal Eye	Webová kamera na video komunikáciu (len určité modely).
2		Obrazovka	Nazýva sa tiež Liquid-Crystal Display (LCD), zobrazuje výstup z počítača (Konfigurácia sa môže v závislosti od modelu líšiť).
3		Reproduktory	Ľavý predný a pravý predný reproduktor poskytuje výstup stereo zvuku.
4		Klávesnica	Slúži na zadávanie údajov do počítača.
5		Dotyková plocha	Zariadenie s citlivosťou na dotyk, ktoré funguje ako počítačová myš.
6		Kontrolka napájania ¹	Signalizuje stav napájania počítača.
		Kontrolka batérie ¹	Signalizuje stav batérie počítača. 1. Nabíjanie: Pri nabíjaní batérie svieti žltá. 2. Nabité: V režime AC svieti modrá.
7		Tlačidlá na klikanie (Ľavé a pravé)	Funkcia ľavého a pravého tlačidla je podobná ako funkcia ľavého a pravého tlačidla myši.
8		Podložka rúk	Pohodlná opora rúk pri práci s počítačom.
9		HDD	Svieti, keď je jednotka pevného disku aktívna.
		Kontrolka komunikácie	Signalizuje stav zariadenia na bezdrôtové pripojenie počítača.
10		Hlavný vypínač	Zapína a vypína počítač.
11		Mikrofón	Interný mikrofón na nahrávanie zvuku.

1. Kontrolky na prednom paneli sú viditeľné, aj keď je veko počítača zatvorené.

Klávesové skratky



Počítač využíva klávesové skratky alebo kombinácie klávesov na prístup k väčšine nastavení počítača, ako je napríklad jas obrazovky a hlasitosť výstupu.

Ak chcete aktivovať klávesové skratky, stlačte a podržte kláves <Fn> pred stlačením ďalšieho klávesu v klávesovej skratke.

Klávesová skratka	Ikona	Funkcia	Popis
<Fn> + <F3>		Komunikácia	Zapína a vypína komunikačné zariadenia počítača. (Komunikačné zariadenia sa môžu líšiť v závislosti od konfigurácie.)
<Fn> + <F4>		Režim spánku	Prepne počítač do režimu spánku.
<Fn> + <F5>		Prepínanie zobrazenia	Prepína výstup zobrazenia – obrazovka, externý monitor (ak je pripojený) a obidva súčasne.
<Fn> + <F6>		Vypnutie obrazovky	Vypína podsvietenie obrazovky kvôli úspore energie. Pre návrat stlačte akúkoľvek klávesu.
<Fn> + <F7>		Prepínanie dotykovej plochy	Zapína a vypína dotykovú plochu.
<Fn> + <F8>		Prepínanie reproduktora	Zapína a vypína reproduktory.
<Fn> + <Δ>		Zvýšenie hlasitosti	Zvyšuje hlasitosť zvuku.
<Fn> + <▽>		Zníženie hlasitosti	Znižuje hlasitosť zvuku.
<Fn> + <▷>		Zvýšenie jasu	Zvyšuje jas obrazovky.
<Fn> + <◁>		Zníženie jasu	Znižuje jas obrazovky.

Pohľad spredu (zatvorený)



#	Ikona	Položka	Popis
1		Kontrolka napájania ¹	Signalizuje stav napájania počítača.
		Kontrolka batérie ¹	Signalizuje stav batérie počítača. 1. Nabíjanie: Pri nabíjaní batérie svieti žltá. 2. Nabité: V režime AC svieti modrá.
2		Čítačka kariet Multi-in-1	Podporuje karty Secure Digital (SD), MultiMediaCard (MMC), Memory Stick (MS), Memory Stick PRO (MS PRO) a xD-Picture Card (xD). Poznámka: Stlačením vytiahnete/vložíte kartu. Nie je možné pracovať s viacerými kartami naraz.







Pohľad zozadu

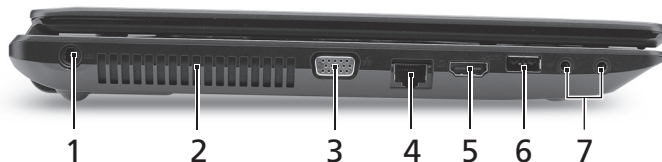

#	Ikona	Položka	Popis
1		Batéria	Poskytuje napájanie počítača, ktoré bude využívanie, keď bude počítač odpojený.



Pohľad zľava



#	Ikona	Položka	Popis
1		Konektor vstupu jednosmerného napätia	Pripojenie adaptéra striedavého napätia.
2		Otvory na ventiláciu	Pomáha udržať pri dlhom používaní počítač chladný.
3		Port externej obrazovky (VGA)	Pripojenie zobrazovacieho zariadenia (napr. externého monitora, LCD projektoru).
4		Port siete Ethernet (RJ-45)	Pripojenie k sieti Ethernet 10/100/1000.
5		Port HDMI	Podporuje pripojenia digitálneho videa s vysokým rozlíšením.
6		Port USB 2.0	Pripojenie zariadení cez rozhranie USB 2.0 (napr. USB myš, USB fotoaparát).
7		Konektor vstupu mikrofónu	Slúži na vstup zvuku z externých mikrofónov.
		Konektor na slúchadlá/reproduktor/ audio výstup	Výstup zvuku do zvukových zariadení (napr. reproduktorov, slúchadiel).

Pohľad sprava





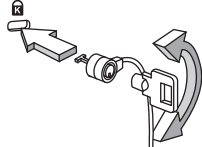

#	Ikona	Položka	Popis
1		Port USB 2.0	Pripojenie zariadení cez rozhranie USB 2.0 (napr. USB myš, USB fotoaparát).
2		Optická mechanika	Interná optická mechanika na CD alebo DVD disky.
3		Indikátor prístupu na optický disk	Svieti, keď je optická mechanika aktívna.
4		Tlačidlo vysúvania optickej mechaniky	Vysúva optický disk z jednotky.
5		Otvor núdzového vysúvania	Vysúva optickú mechaniku pri vypnutom počítači. Poznámka: Keď je počítač vypnutý, optickú jednotku vysuniete zasunutím kancelárskej sponky do núdzového otvoru.
6		Zásuvka na zámok Kensington	Pripojenie počítačového bezpečnostného kľúča Kensington. Poznámka: Pripojte kábel bezpečnostného zámku počítača k nepohyblivému predmetu, napríklad stolu alebo držadlu zaistenej zásuvky. Vložte zámok do otvoru a otočte kľúčom kvôli zaisteniu zámku. Niektoré modely sú dostupné aj bez zámku.

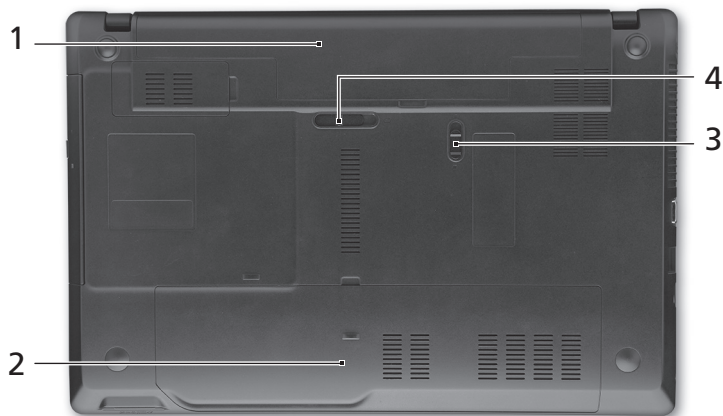

Pohľad zdola



#	Ikona	Položka	Popis
1		Jednotka batérie	Slúži na uloženie batérie počítača.
2		Jednotka pevného disku	Slúži na uchytenie pevného disku počítača (zaistené skrutkou).
		Pozícia pre pamäť	Tu je uložená hlavná pamäť počítača.
3		Zámok batérie	Uzamyká batériu na jej mieste.
4		Západka uvoľnenia batérie	Slúži na uvoľnenie batérie pri jej vyberaní.

Prostredie

- Teplota:
 - Prevádzková: 5°C až 35°C
 - Mimoprevádzková: -20°C až 65°C
- Vlhkosť (nekondenzačná):
 - Prevádzková: 20% až 80%
 - Mimoprevádzková: 20% až 80%

Seriya TravelMate 5740/ 5740Z/5340

Hitri vodič

© 2010 Vse pravice pridržane.

Hitri vodič za serijo TravelMate 5740/5740Z/5340

Originalna izdaja: 03/2010

Prenosni računalnik serije TravelMate 5740/5740Z/5340

Številka modela: _____

Serijska številka: _____

Datum nakupa: _____

Mesto nakupa: _____

Začnimo pri začetku

Želimo se vam zahvaliti, ker ste za zadovoljevanje prenosnih računalniških potreb izbrali prenosnik Acer.

Vaša navodila

Za pomoč pri uporabi vašega prenosnika Acer, smo izdelali paket navodil:

Namestitveni plakat vam bo pomagal pri nastavitvi vašega računalnika.

Natisnjeni splošni **uporabniški priročnik serije TravelMate** vsebuje uporabne informacije, ki veljajo za vse modele serije izdelkov TravelMate. Pokriva osnovne teme, kot so uporaba tipkovnice in zvočnih nastavitev itd. Prosimo, da upoštevate, da se spodaj omenjeni **uporabniški priročnik AcerSystem** zaradi svoje splošnostivčasih nanaša na funkcije ali lastnosti, ki jih imajo le nekateri modeli iz serije, ne pa nujno tudi model, ki ste ga kupili. Takšni primeri so označeni z napisom „velja le za določene modele“.

Hitri vodič vsebuje osnovne funkcije vašega novega računalnika. Za več informacije o tem kako vam lahko računalnik pomaga postati bolj produktive, prosimo glejte uporabniški priročnik **AcerSystem**. Ta navodila vsebujejo podrobne informacije o sistemskih pripomočkih, obnovi podatkov, možnostih razširitve in odpravljanju težav. Poleg tega vsebuje garancijske informacije in splošne uredbe in varnostna obvestila za vaš prenosnik. Navodila so na voljo v obliki prenosnega dokumenta (PDF) in so naložena na vaš prenosnik. Da bi ga našli, sledite naslednjim korakom:

- 1 Kliknite **Start > Vse programi > AcerSystem**.
- 2 Kliknite na **Uporabniški priročnik AcerSystem**.







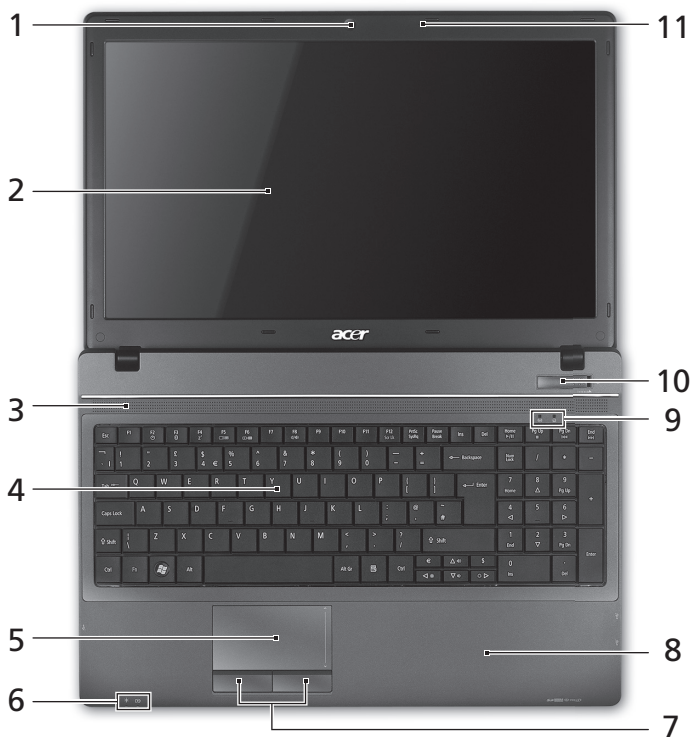

Opomba: Za pregledovanje datoteke potrebujete Adobe Reader. Če Adobe Reader ni nameščen na računalnik se bo zagnal namestitveni program Adobe Reader, ko kliknete na **uporabniški priročnik AcerSystem**. Za zaključek postopka sledite navodilom na zaslonu. Za navodila o uporabi Adobe Reader, odprite meni **Pomoč in podpora**.

Vodič po vašem prenosniku Acer

Ko ste nastavili računalnik, kot je prikazano na plakatu **Za začetek...**, dovolite, da vam predstavimo vaš novi prenosnik Acer.

Pogled od zgoraj













#	Ikona	Predmet	Opis
1		Integrirana spletna kamera Acer Crystal Eye	Spletna kamera za video komunikacijo (le za določene modele).
2		Zaslon	Takoimenovani zaslon s tekoimi kristali (LCD), prikazuje izhod vašega računalnika (Konfiguracija je za različne modele razlina).
3		Zvočniki	Sprednji levi in sprednji desni zvočnik nudita zvočni izhod stereo.
4		Tipkovnica	Za vnos podatkov v računalnik.
5		Sledilna plošča	Na dotik občutljiva naprava, ki deluje kot računalniška miška.
6		Indikator stanja napajanja ¹	Označuje stanje napajanja računalnika.
		Indikator stanja baterije ¹	Označuje stanje baterije računalnika. 1. Polnjenje: Lučka sveti rumenkasto rjavo, ko se baterija polni. 2. V celoti napolnjena: V načinu AC lučka sveti modro.
7		Tipke (levo in desno)	Leva in desna tipka deluje kot leva in desna tipka na miški.
8		Podpora za dlan	Udobna podpora za vaše roke, ko uporabljate računalnik.
9		HDD	Označuje, ko je trdi disk aktiven.
		Indikator komunikacije	Označuje stanje naprave za brezžično povezavo.
10		Gumb za vklop/izklop	Vklop in izklop računalnika.
11		Mikrofon	Notranji mikrofon za snemanje zvoka.

1. Indikatorji na sprednji plošči so vidni tudi, ko je pokrov računalnika zaprt.

Vročé tipke



Računalnik uporablja vroče tipke ali kombinacijo tipk za dostop do računalniških nastavitev kot sta svetlost zaslona in glasnost.

Za aktiviranje vročih tipk pritisnite in držite tipko **<Fn>** preden pritisnete drugo tipko v kombinaciji.

Vročá tipka	Ikona	Funkcija	Opis
<Fn> + <F3>		Komunikacija	Omogoči/onemogoči komunikacijske naprave računalnika. (Komunikacijske naprave se lahko razlikujejo po konfiguraciji.)
<Fn> + <F4>		Mirovanje	Preklopi računalnik v stanje mirovanja.
<Fn> + <F5>		Preklop zaslona	Preklopi izhod zaslona med zaslonom, zunanjim monitorjem (če je priključen) in obema.
<Fn> + <F6>		Izklop zaslona	Izključi luč zaslona za varčevanje z energijo. Pritisnite poljubno tipko za vrnitev.
<Fn> + <F7>		Preklop sledilne plošče	Vklop in izklop sledilne plošče.
<Fn> + <F8>		Preklop zvočnikov	Vklop in izklop zvočnikov.
<Fn> + <Δ>		Povečanje glasnosti	Poveča glasnost zvoka.
<Fn> + <▽>		Zmanjšanje glasnosti	Zmanjša glasnost zvoka.
<Fn> + <▷>		Poveča svetlost	Poveča svetlost zaslona.
<Fn> + <◁>		Zmanjša svetlost	Zmanjša svetlost zaslona.

Zaprto pogled od spredaj



#	Ikona	Predmet	Opis
1		Indikator stanja napajanja ¹	Označuje stanje napajanja računalnika.
		Indikator stanja baterije ¹	Označuje stanje baterije računalnika. 1. Polnjenje: Lučka sveti rumenkasto rjavo, ko se baterija polni. 2. V celoti napolnjena: V načinu AC lučka sveti modro.
2		Čitalec kartic več-v-1	Sprejema Secure Digital (SD), MultiMediaCard (MMC), Memory Stick (MS), Memory Stick Pro (MS PRO), in xD-kartico za fotografije. Opomba: Pritisnite, da bi odstranili/vstavili kartico. Naenkrat lahko uporabljate le eno kartico.







Pogled od zadaj

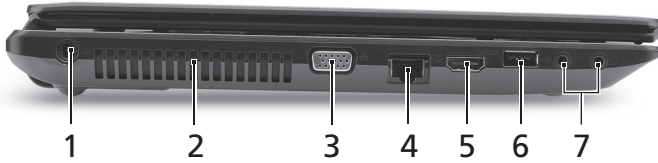

#	Ikona	Predmet	Opis
1		Baterija	Služi napajanju računalnika, ko je električni kabel izključen.



Pogled iz leve strani



#	Ikona	Predmet	Opis
1		Priključek napajalnika	Priključek na AC napajalnik.
2		Reže za prezračevanje	Omogočajo, da računalnik ostane hladen tudi po dolgotrajni uporabi.
3		Priključek za zunanji zaslon (VGA)	Priključitev na prikazovalno napravo (npr. zunanji monitor, projektor LCD).
4		Priključek Ethernet (RJ-45)	Priključek na omrežja Ethernet 10/100/1000.
5		Vhod HDMI	Podpira priključke za visokoločljivostni digitalni video.
6		Vrata USB 2.0	Prikljuek za naprave USB 2.0 (npr., USB miška, USB fotoaparata).
7		Vtičnica za mikrofona	Sprejema vhode iz zunanjih mikrofonov.
		Vtičnica za slušalke/zvočnik/napravo	Priključek za avdio naprave (npr. zvočniki, slušalke).

Pogled iz desne strani





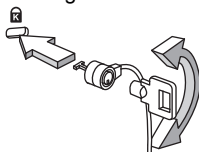

#	Ikona	Predmet	Opis
1		Vrata USB 2.0	Priključek za naprave USB 2.0 (npr., USB miška, USB fotoaparata).
2		Optični pogon	Notranji optični pogon; sprejema CD-je ali DVD-je.
3		Pokazatelj dostopa do optičnega diska	Zasveti, ko je optični pogon aktiven.
4		Tipka za izvržbi optični pogon	Izvrže optični disk iz pogona.
5		Luknja za izvržbo v nujnem primeru	Izvrže pladenj optičnega pogona, ko je računalnik izključen. Opomba: Vstavite sponko v luknjo za izvržbo v nujnem primeru, da izvržete pladenj optičnega pogona, ko je računalnik izključen.
6		Reža za zaklep Kensington	Priključek za Kensington združljivo računalniško ključavnico. Opomba: Ovijte varnostni kabel okoli nepremičnega predmeta, kot je miza ali ročaj zaklenjenega predala. Vstavite zaklep v zarezo in obrnite ključ, da ga zaklenete. Na voljo so tudi nekateri modeli brez ključev.

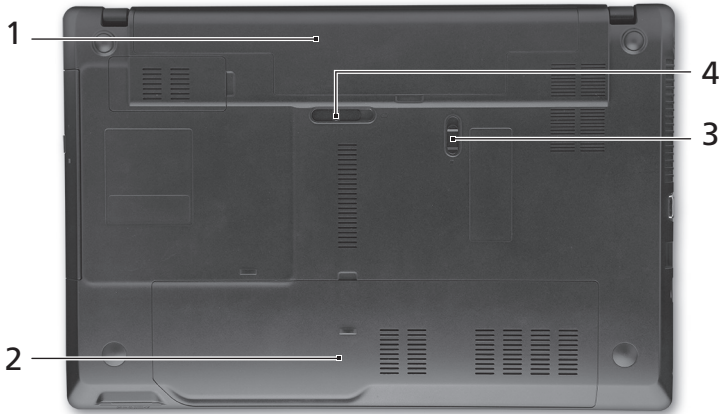

Pogled od spodaj



#	Ikona	Predmet	Opis
1		Nosilec za baterijo	Hrani baterijo računalnika.
2		Nosilec trdega diska	Hrani trdi disk računalnika (pričvrščeno z vijaki).
		Razdelek za pomnilnik	Hrani glavni spomin računalnika.
3		Zaklep za baterijo	Zaklene baterijo na mesto.
4		Zapah za sprostitvev baterije	Sprostitev baterije za odstranjevanje.

Okolje

- Temperatura:
 - Delovanje: 5°C do 35°C
 - Mirovanje: -20°C do 65°C
- Vlažnost (brez kondenza):
 - Delovanje: 20% do 80%
 - Mirovanje: 20% do 80%

TravelMate 5740/5740Z/5340 serije

Kratki vodič

© 2010 Sva prava pridržana.

TravelMate 5740/5740Z/5340 serije - kratki vodič
Izvorno izdanje: 03/2010

TravelMate 5740/5740Z/5340 serije prijenosno osobno računalo

Broj modela: _____

Serijski broj: _____

Datum kupovine: _____

Mjesto kupovine: _____

Prvo osnovne stvari

Željeli bismo vam zahvaliti na izboru Acer prijenosnog računala koje će vam poslužiti kamo god krenuli.

Vaši vodiči

Kako bismo Vam pomogli pri uporabi Vašeg Acer prijenosnog računala, kreirali smo skup vodiča:

Na samom početku, **poster** vam pomaže u postavljanju vašeg računala.

Opći priručnik za korisnike TravelMate serije sadrži korisne informacije koje se odnose na sve modele proizvoda TravelMate serije. Priručnik obuhvaća osnovne teme poput Acer Empowering tehnologije, uporabe tipkovnice, zvuka, i sl. Obratite pažnju na činjenicu kako su zbog načina izdavanja dolje navedenog **AcerSystem priručnika za korisnike** ponekad navedena obilježja ili funkcije koje su dostupne samo na određenim modelima serije, ne nužno i na modelu koji ste vi kupili. U takvim slučajevima bit će naveden tekst poput "samo za određene modele".

Kratki vodič upoznaje vas s osnovnim obilježjima i funkcijama vašeg novog računala. Više informacija o tome kako vam računalo može povećati produktivnost, molimo, pogledajte **AcerSystem Korisnički vodič**. Priručnik sadrži detaljne informacije o temama kao što su uslužni programi sustava, vraćanje podataka, opcije za proširivanje i rješavanje problema. Nadalje, sadrži informacije o jamstvima i osnovne obavijesti o propisima i sigurnosti za vaš prijenosnik. Priručnik je dostupan u Portable Document Formatu (PDF), a dolazi i snimljen na prijenosnik. Za pristup priručniku, učinite sljedeće:

- 1 Kliknite na **Početak > Svi programi > AcerSystem**.
- 2 Kliknite na **AcerSystem korisnički vodič**.



.....



Napomena: Za pregled dokumenta potreban je Adobe Reader. Ako na računalo nemate instaliran Adobe Reader, klik na **AcerSystem korisnički vodič** najprije će pokrenuti program za instalaciju Adobe Readera. Slijedite upute na zaslonu da biste završili instalaciju. Za upute kako koristiti Adobe Reader, pristupite izborniku **Pomoć i podrška**.

Upoznajte Acer prijenosnik

Nakon postavljanja vašeg računala kao što je ilustrirano na posteru **Tek za početak...**, dopustite nam da vas upoznamo s vašim novim Acer prijenosnikom.

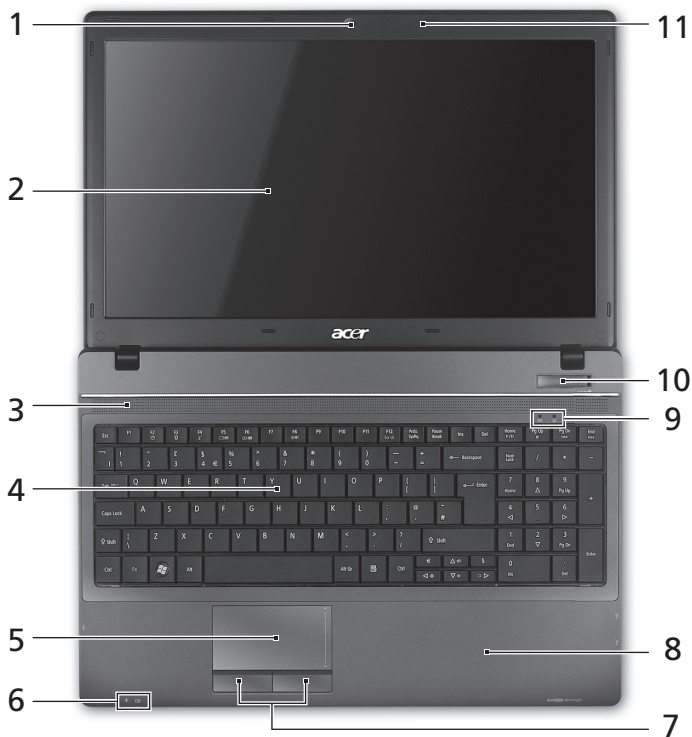
Pogled odozgo













#	Ikona	Stavka	Opis
1		Acer Crystal Eye web kamera	Web kamera za video komunikaciju (samo za određene modele).
2		Zaslon prikaza	Poznat i pod nazivom zaslon s tekućim kristalima (Liquid-Crystal Display-LCD), prikazuje izlaz računala (konfiguracija se može razlikovati ovisno o modelu).
3		Zvučnici	Prednji lijevi i prednji desni zvučnici daju stereo audio izlaz.
4		Tipkovnica	Za unos podataka u vaše računalo.
5		Dodirna ploča	Pokazivački uređaj osjetljiv na dodir koji funkcionira kao računalni miš.
6		Indikator napajanja ¹	Pokazuje stanje napajanja računala.
		Indikator baterije ¹	Pokazuje stanje baterije računala. 1. Punjenje: Svijetli žuto kada se baterija puni. 2. Sasvim napunjeno: Svijetli plavo kada radi na izmjeničnom napajanju.
7		Tipke za odabir (lijeva i desna)	Lijeva i desna tipka funkcionira kao lijeva i desna tipka miša.
8		Oslonac za dlanove	Udobno područje koje pruža potporu rukama dok koristite računalo.
9		HDD	Pokazuje kada je pogon tvrdog diska aktivan.
		Indikator komunikacije	Pokazuje status uređaja za bežično spajanje računala.
10		Glavni prekidač	Uključuje i isključuje računalo.
11		Mikrofon	Unutarnji mikrofon za snimanje zvuka.

1. Indikatori na prednjoj ploči su vidljivi čak i kada je poklopac računala zatvoren.

Vruće tipke



Računalo koristi "vruće" tipke ili kombinacije tipki za pristup većini upravljačkih tipki računala, kao što je osvijetljenost zaslona i izlazna glasnoća.

Za aktiviranje „vruće“ tipke, pritisnite i držite **<Fn>** tipku prije pritiskanja druge tipke u kombinaciji "vrućih" tipki.

„Vruća“ tipka	Ikona	Funkcija	Opis
<Fn> + <F3>		Komunikacija	Omogućava/onemogućava komunikacijske uređaje računala. (Komunikacijski uređaji razlikuju se prema konfiguraciji.)
<Fn> + <F4>		Stanje mirovanja	Stavlja računalo u stanja mirovanja.
<Fn> + <F5>		Prekidač prikaza	Prebacuje izlaz prikaza između zaslona prikaza, vanjskog monitora (ako je priključen) i oba.
<Fn> + <F6>		Isključivanje zaslona	Isključuje pozadinsko osvijetljenje zaslona prikaza radi uštede energije. Pritisnite bilo koju tipku da se vratite.
<Fn> + <F7>		Prekidač dodirne ploče	Uključuje i isključuje dodirnu ploču.
<Fn> + <F8>		Prekidač zvučnika	Uključuje i isključuje zvučnike.
<Fn> + <Δ>		Pojačavanje glasnoće	Pojačava glasnoću zvuka.
<Fn> + <▽>		Smanjivanje glasnoće	Smanjuje glasnoću zvuka.
<Fn> + <▷>		Povećanje osvijetljenosti	Povećava osvijetljenost zaslona.
<Fn> + <◁>		Smanjivanje osvijetljenosti	Smanjuje osvijetljenost zaslona.

Pogled sprijeda izbliza



#	Ikona	Stavka	Opis
1		Indikator napajanja ¹	Pokazuje stanje napajanja računala.
		Indikator baterije ¹	<p>Pokazuje stanje baterije računala.</p> <p>1. Punjenje: Svijetli žuto kada se baterija puni.</p> <p>2. Sasvim napunjeno: Svijetli plavo kada radi na izmjeničnom napajanju.</p>
2		Više-u-1 čitač kartica	<p>Prihvaća Secure Digital (SD), MultiMediaCard (MMC), Memory Stick (MS), Memory Stick PRO (MS PRO), xD-Picture Card (xD) kartice.</p> <p>Napomena: Gurnite za uklanjanje/postavljanje kartice. Istodobno u pogonu možete koristiti samo jednu karticu.</p>







Pogled straga

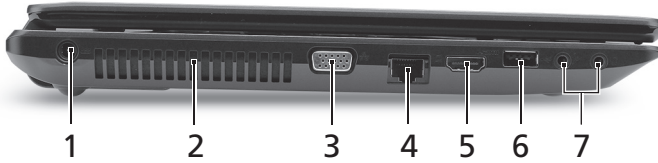

#	Ikona	Stavka	Opis
1		Baterija	Osigurava napajanje računala dok je isključeno s izvora napajanja.



Pogled s lijeve strane



#	Ikona	Stavka	Opis
1		DC-in utičnica	Povezuje se s AC adapterom.
2		Utori za prozračivanje	Omogućavaju rashlađivanje računala i prilikom dugotrajne uporabe.
3		Priključak vanjskog ekrana (VGA)	Povezuje se s uređajem za prikaz (primjerice vanjskim monitorom, LCD projektorom).
4		Ethernet (RJ-45) priključak	Povezuje se na Ethernet 10/100/1000-baziranu mrežu.
5		HDMI ulaz	Podržava veze digitalnog videa visoke definicije.
6		USB 2.0 priključak	Povezuju se s USB 2.0 uređajima (npr. USB miš, USB kamera).
7		Utičnica ulaza za mikrofona	Prihvaća ulaze iz vanjskih mikrofona.
		Utičnica za slušalice/zvučnike/line-out	Povezuje se sa line-out audio uređajima (npr. zvučnicima, slušalicama).

Pogled s desne strane





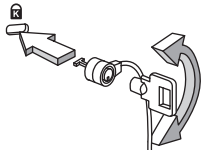

#	Ikona	Stavka	Opis
1		USB 2.0 priključak	Povezuje se sa USB 2.0 uređajima (primjerice USB miš, USB kamera).
2		Optički pogon	Unutarnji optički pogon; prihvaća CD-e ili DVD-e.
3		Indikator pristupa optičkom disku	Svijetli kada je optički pogon aktivan.
4		Gumb za izbacivanje optičkog pogona	Izbacuje optički disk iz pogona.
5		Otvor za izbacivanje u slučaju nužde	Izbacuje ladicu optičkog pogona kada je računalo isključeno. Napomena: Umetnite spajalicu za papir u otvor za izbacivanje u slučaju nužde kako bi izbacili ladicu optičkog pogona kada je računalo isključeno.
6		Utor za Kensington bravu	Povezuje se s Kensington - kompatibilnom računalnom sigurnosnom bravom. Napomena: Omotajte kabel sigurnosne brave računala oko nepokretnog objekta kao što je stol ili ručka zaključane ladicke. Umetnite bravu u utor i okrenite ključ kako bi osigurali bravu. Dostupni su i neki modeli bez ključa.

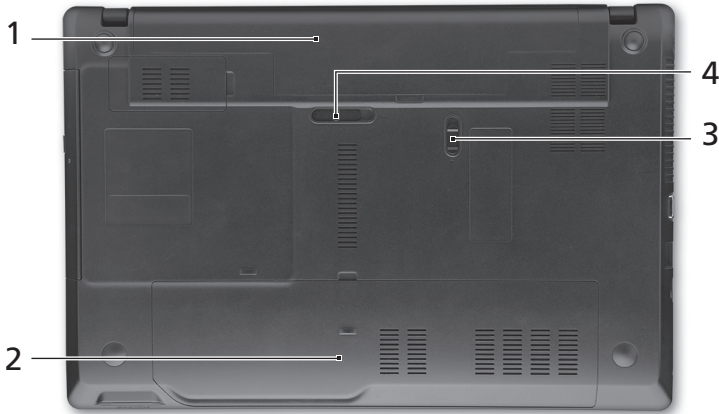

Pogled odozdo



#	Ikona	Stavka	Opis
1		Prostor za bateriju	Sadrži baterijski komplet računala.
2		Prostor za tvrdi disk	Sadrži tvrdi disk računala (učvršćen vijcima).
		Odjeljak za memoriju	Sadrži glavnu memoriju računala.
3		Brava baterije	Zaključava bateriju u njen položaj.
4		Bravica za oslobađanje baterije	Oslobađa bateriju radi uklanjanja.

Okruženje

- Temperatura:
 - Radna: 5°C do 35°C
 - Pohrana: - 20°C do 65°C
- Vlažnost (nekondenzirajuća):
 - Radna: 20% do 80%
 - Pohrana: 20% do 80%

Seria TravelMate 5740/ 5740Z/5340

Ghid rapid

© 2010 Toate drepturile rezervate.

Ghid rapid seria TravelMate 5740/5740Z/5340

Prima ediție: 03/2010

Notebook seria TravelMate 5740/5740Z/5340

Numărul modelului: _____

Numărul seriei: _____

Data achiziției: _____

Locul achiziției: _____

Înainte de toate

Dorim să vă mulțumim că ați ales un computer portabil Acer pentru a răspunde nevoilor dvs de procesare mobilă.

Ghidurile dumneavoastră

Pentru a vă ajuta să folosiți computerul portabil Acer, am conceput un set de ghiduri:

Primul dintre acestea, **posterul de configurare** vă ajută să începeți configurarea computerului.

Ghidul general de utilizare pentru seria TravelMate conține informații utile, valabile pentru toate modelele din gama TravelMate. Acest ghid acoperă subiecte de bază, cum ar fi folosirea tastaturii, a sistemului audio etc. Vă rugăm să rețineți că **Ghidul utilizatorului AcerSystem** menționat mai jos se referă ocazional la funcții sau caracteristici care sunt incluse doar în anumite modele ale seriei și nu neapărat în modelul cumpărat de dumneavoastră. Astfel de cazuri sunt marcate în manuale prin texte cum ar fi „doar pentru anumite modele”.

Acest **Ghid rapid** vă prezintă caracteristicile și funcțiile de bază ale noului dvs. computer. Pentru mai multe informații privind modul în care computerul vă poate ajuta să fiți mai productiv, consultați **Ghidul utilizatorului AcerSystem**. Acest ghid conține informații detaliate despre astfel de subiecte, precum utilizările de sistem, recuperarea datelor, opțiunile de extensie și depanarea. În plus, acesta conține informații despre garanție, reglementări generale și note de siguranță pentru computerul dvs portabil. Este disponibil în Format de document portabil (PDF) și vine preîncărcat pe computerul dvs. portabil. Urmați acești pași pentru a-l accesa:

- 1 Dați clic pe **Start > Toate programele > AcerSystem**.
- 2 Faceți clic pe **Ghidul utilizatorului AcerSystem**.







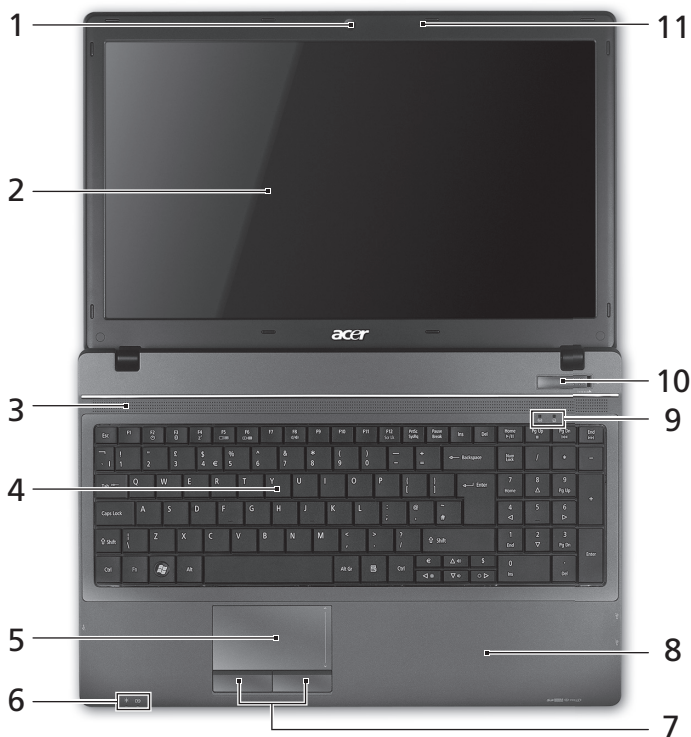

Notă: Vizualizarea fișierului necesită Adobe Reader. Dacă Adobe Reader nu este instalat pe computerul dvs., faceți clic pe **Ghidul utilizatorului AcerSystem** și se va executa mai întâi programul de configurare Adobe Reader. Pentru a încheia instalarea, urmați instrucțiunile de pe ecran. Pentru instrucțiuni privind modul de utilizare a Adobe Reader, accesați meniul **Ajutor și asistență**.

Turul computerului dvs Acer

După configurarea computerului, așa cum se arată în afișul **Nu mai pentru începători...**, permiteți-ne să vă prezentăm computerul portabil Acer.

Vedere de sus













#	Pictogramă	Element	Descriere
1		Cameră web Acer Crystal Eye	Cameră Web pentru comunicare video (doar pentru anumite modele).
2		Ecran de afișaj	Mai este numit și Afișaj cu cristale lichide (LCD) și afișează activitatea computerului (Configurația poate diferi în funcție de model).
3		Difuzoare	Difuzoarele din stânga și dreapta față redau sunetul stereo.
4		Tastatură	Pentru introducerea datelor în computer.
5		Zona de atingere	Dispozitiv de indicare sensibil la atingere care funcționează ca un maus de computer.
6		Indicator de alimentare ¹	Indică nivelul de alimentare al computerului.
		Indicator baterie ¹	Indică starea bateriei computerului. 1. Încărcare: Lumina este galbenă când acumulatorul se încarcă. 2. Complet încărcat: Lumina este albastră în modul c.a.
7		Butoane de clic (stânga și dreapta)	Butoanele stânga și dreapta funcționează ca butoanele stânga și dreapta ale mousului.
8		Placă pentru sprijinirea palmei	Zonă confortabilă de sprijin pentru mână atunci când folosiți computerul.
9		HDD	Indică atunci când unitatea de harddisc este activă.
		Indicator comunicare	Indică starea dispozitivului de conectare wireless al computerului.
10		Înterupător de pornire/oprire	Pornește și oprește computerul.
11		Microfon	Microfon intern pentru înregistrarea sunetului.

1. Indicatorii de pe panoul frontal sunt vizibile chiar și atunci când capacul computerului este închis.

Taste rapide



Computerul folosește tastele rapide sau combinațiile de taste pentru a accesa majoritatea comenzilor precum luminozitatea ecranului și volumul.

Pentru a activa tastele rapide, apăsați și mențineți tasta <Fn> înainte de a apăsa cealaltă tastă din combinația de tastă rapidă.

Tastă rapidă	Pictogramă	Funcție	Descriere
<Fn> + <F3>		Comunicații	Activează/dezactivează dispozitivele de comunicație ale computerului. (Dispozitivele de comunicație pot diferi în funcție de model.)
<Fn> + <F4>		Repaus	Pune computerul în modul Repaus.
<Fn> + <F5>		Comutare afișaj	Comută afișajul între ecran de afișaj, monitor extern (dacă este conectat) și ambele.
<Fn> + <F6>		Oprire afișaj	Oprește lumina de fundal a ecranului pentru a economisi energie. Apăsați orice tastă pentru reveni.
<Fn> + <F7>		Comutator suport tactil	Pornește și oprește suportul tactil.
<Fn> + <F8>		Comutare difuzor	Pornește și oprește difuzoarele.
<Fn> + <Δ>		Volum mărit	Mărește volumul sunetului.
<Fn> + <▽>		Volum scăzut	Reduce volumul sunetului.
<Fn> + <▷>		Luminozitate mărită	Mărește luminozitatea afișajului.
<Fn> + <◁>		Luminozitate scăzută	Reduce luminozitatea afișajului.

Vedere din față de aproape



#	Pictogramă	Element	Descriere
1		Indicator de alimentare ¹	Indică nivelul de alimentare al computerului.
		Indicator baterie ¹	Indică starea bateriei computerului. 1. Încărcare: Lumina este galbenă când acumulatorul se încarcă. 2. Complet încărcat: Lumina este albastră în modul c.a.
2		Cititor de cartele multi-in-1	Acceptă carduri Secure Digital (SD), MultiMediaCard (MMC), Memory Stick (MS), Memory Stick PRO (MS PRO) și xD-Picture Card. Notă: Apăsați pentru a extrage/a instala cardul. Nu poate fi citit decât un singur card o dată.







Vedere din spate

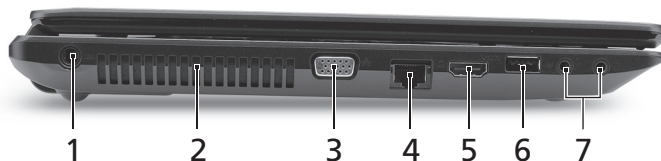

#	Pictogramă	Element	Descriere
1		Acumulator	Asigură energia computerului atunci când acesta nu este racordat la o priză de energie electrică.



Vedere din stânga



#	Pictogramă	Element	Descriere
1		Mufă c.c. intrare	Conectează la un adaptor de c.a.
2		Orificii de aerisire	Permit computerului să rămână rece, chiar și după utilizarea prelungită.
3		Port pentru afișaj extern (VGA)	Conectează la un dispozitiv de afișare (de ex. monitor extern sau proiector LCD).
4		Port Ethernet (RJ-45)	Conectează la o rețea Ethernet 10/100/1000.
5		Port HDMI	Acceptă conexiuni video digitale de înaltă definiție.
6		Port USB 2.0	Conectează la dispozitivele USB 2.0 (de ex. maus USB, cameră USB).
7		Mufă intrare microfon	Acceptă intrări de la microfoane externe.
		Mufă de căști/difuzor/ieșire	Conectează la dispozitivele audio de ieșire (de ex. difuzoare, căști).

Vedere din dreapta





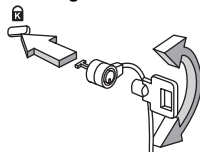

#	Pictogramă	Element	Descriere
1		Port USB 2.0	Conectează la dispozitivele USB 2.0 (de ex. maus USB, cameră USB).
2		Unitate optică	Unitate optică internă, acceptă CD-uri sau DVD-uri.
3		Indicator de acces la discul optic	Se aprinde când unitatea optică este activă.
4		Buton de eliminare unitate optică	Elimină discul optic din unitate.
5		Orificiu de eliminare de urgență	Elimină tava unității optice când computerul este oprit. Notă: Introduceți o bucată de hârtie în orificiul de eliminare de urgență pentru a elimina tava unității optice când computerul este oprit.
6		Slot de blocare Kensington	Conectează la un dispozitiv de securitate pentru computer compatibil Kensington. Notă: Înfășurați cablul blocajului de securitate al computerului în jurul unui obiect fix precum o masă sau un mâner al unui sertar încuiat. Introduceți blocajul în zăvor și răsuciți cheia pentru a fixa blocajul. Sunt disponibile și unele modele fără chei.

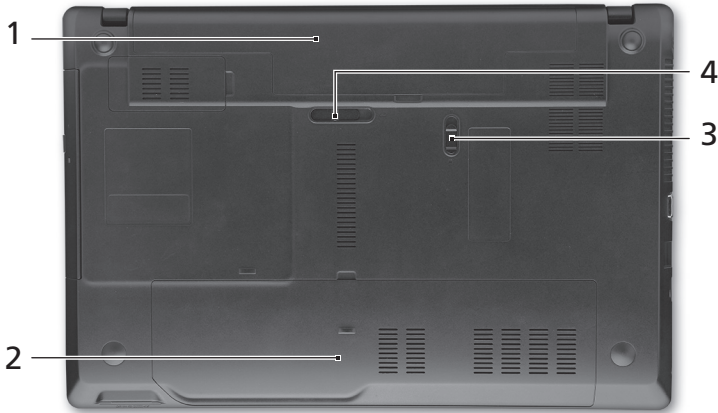

Vedere bază



#	Pictogramă	Element	Descriere
1		Nișa pentru acumulator	Adăpostește setul de acumulatori ai computerului.
2		Nișă unitate de harddisc	Adăpostește unitatea harddisc a computerului (fixată cu șuruburi).
		Compartiment de memorie	Adăpostește memoria principală a computerului.
3		Blocaj acumulator	Blochează acumulatorul în poziție.
4		Zăvor de eliberare a acumulatorului	Eliberează acumulatorul pentru a fi scos.

Mediu

- Temperatură:
 - Funcționare: 5°C - 35°C
 - Nefuncționare: -20°C - 65°C
- Umiditate (fără condens):
 - Funcționare: 20% - 80%
 - Nefuncționare: 20% - 80%

Серия TravelMate 5740/ 5740Z/5340

Кратко ръководство

© 2010 Всички права запазени.

Кратко ръководство за Серия TravelMate 5740/5740Z/5340

Първоначално издание: 03/2010

Серия TravelMate 5740/5740Z/5340 Персонален ноутбук

Модел номер: _____

Сериен номер: _____

Дата на закупуване: _____

Място на закупуване: _____

Преди всичко

Бихме желали да Ви благодарим, че сте избрали ноутбук на Acer за Вашите нужди в областта на мобилните компютри.

Вашите ръководства

За да Ви помогнем при употребата на Вашия ноутбук Acer, ние изготвихме следните ръководства:

Първо, **плаката с настройки** Ви помага с началните настройки на компютъра.

Общо ръководство на сериите TravelMate съдържа информация, която е валидна за всички модели в продуктите серии TravelMate product. Покрива основни теми, като например използване на клавиатурата и аудио. Важно е да знаете, че поради обобщаващия си характер, упоменатото по-долу **Потребителското ръководство AcerSystem**, на места се отнася до функции и опции, които са налични само за конкретни модели от сериите, без това да означава, че тези функции и опции трябва да бъдат налични за модела, който сте закупили. Тези случаи са отбелязани в текста със забележки като "само за някои модели".

Това **Бързо ръководство** Ви представя основните функции и възможности на новия Ви компютър. За повече информация как Вашият компютър може да Ви помогне да сте по-продуктивни, моля, вижте **Потребителското ръководство AcerSystem**. То съдържа подробна информация за теми като системни инструменти, възстановяване на данни, опции за актуализация и решаване на проблеми. В допълнение, то съдържа и гаранционна информация, както и основните наредби и бележки за безопасност, свързани с Вашия ноутбук. То е в PDF формат (Portable Document Format) и е предварително заредено на ноутбука Ви. За да го отворите, следвайте тези стъпки:

- 1 Щракнете върху **Start (Старт) > All Programs (Всички програми) > AcerSystem**.
- 2 Щракнете върху **AcerSystem User Guide (Потребителско ръководство AcerSystem)**.







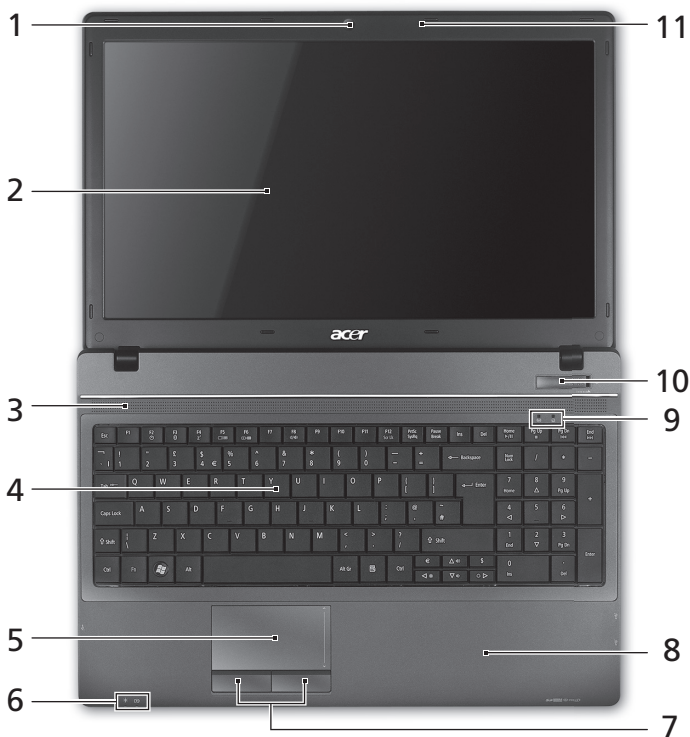

Забележка: За да отворите файла Ви е нужен Adobe Reader. Ако Adobe Reader не е инсталиран на компютъра Ви, натискането върху **Потребителското ръководство AcerSystem**, първо ще стартира инсталационната програма на Adobe Reader. Следвайте инструкциите на екрана, за да извършите инсталацията. За инструкции как се използва Adobe Reader, отворете менюто **Help and Support (Помощ и поддръжка)**.

Преглед на Вашия ноутбук Асер

След като настроите компютъра си, както е показано в постера **Като за начало...**, ще Ви покажем какво прави и какво има Вашият нов ноутбук Асер.

Изглед отгоре



#	Икона	Обект	Описание
1		Уеб камера Асер Crystal Eye	Уеб камера за видео комуникации (само за някои модели).
2		Дисплей	Нарича се още "Течнокристален дисплей" (LCD) и е екранът на компютъра (конфигурацията може да се различава в зависимост от моделите).
3		Високоговорители	Преден ляв и преден десен високоговорител за стерео аудио възпроизвеждане.
4		Клавиатура	Служи за въвеждане на данни в компютъра Ви.
5		Тъчпад	Чувствително на допир посочващо устройство, което функционира като компютърна мишка.
6		Индикатор на захранването ¹	Показва статуса на захранване на компютъра.
		Индикатор за нивото на батерията ¹	Посочва статуса на батерията на компютъра. 1. Зареждане: Индикаторът свети в жълто, докато батерията се зарежда. 2. Напълно заредена: Индикаторът свети в синьо, когато сте в режим АС.
7		Бутони за кликване (ляв и десен)	Левият и десният бутони функционират като ляв и десен бутон на мишка.
8		Подложка за длани	Удобно място, на което да поставите ръцете си, когато използвате компютъра.
9		HDD	Посочва дали твърдият диск е активен.
		Индикатор за комуникации	Посочва статуса на устройството за безжична връзка на компютъра.
10		Бутон за включване и изключване	С него компютърът се включва и изключва.
11		Микрофон	Вътрешен микрофон за запис на звук.

1. Индикаторите на предния панел остават видими дори, когато капакът на компютъра е затворен.

Бързи клавиши



Компютърът има "бързи клавиши" - клавишни комбинации за бърз достъп до повечето от контролите му, като например яркост на дисплея и сила на звука.

За да активирате бързите клавиши, натиснете и задръжте клавиша **<Fn>** преди да натиснете другия клавиш от комбинацията.

Бърз клавиш	Икона	Функция	Описание
<Fn> + <F3>		Комуникации	Включва/изключва устройствата за комуникация на компютъра. (Устройствата за комуникация може да варират според конфигурацията.)
<Fn> + <F4>		Заспиване	Вкарва компютъра в режим "Заспиване".
<Fn> + <F5>		Превключване на дисплей	Превключва активния дисплей между екрана, външния монитор (ако е свързан такъв), или и двете.
<Fn> + <F6>		Изкл. дисплей	Изключва задното осветление на екрана, за да пести енергия. Натиснете който и да е клавиш, за да го включите отново.
<Fn> + <F7>		Превключване на тъчпада	С него мишката се включва и изключва.
<Fn> + <F8>		Превключване на високоговорителите	Включва и изключва високоговорителите.
<Fn> + <Δ>		Засилване на звука	Усилва силата на звука.
<Fn> + <▽>		Намаляване на звука	Намалява силата на звука.
<Fn> + <▷>		Засилване на яркостта	Увеличава яркостта на екрана.
<Fn> + <◁>		Намаляване на яркостта	Намалява яркостта на екрана.

Преден изглед при затворен лаптоп



#	Икона	Обект	Описание
1		Индикатор на захранването ¹	Показва статуса на захранване на компютъра.
		Индикатор за нивото на батерията ¹	Посочва статуса на батерията на компютъра. 1. Зареждане: Индикаторът свети в жълто, докато батерията се зарежда. 2. Напълно заредена: Индикаторът свети в синьо, когато сте в режим AC.
2		Четец на карти Много-в-1	Чете Secure Digital (SD), MultiMediaCard (MMC), Memory Stick (MS), Memory Stick PRO (MS PRO) и xD Picture Card (xD). Забележка: Натиснете, за да извадите/деинсталирате картата. Само една карта може да работи едновременно.

Изглед отзад



#	Икона	Обект	Описание
1		Батерия	Захранва компютъра, за да се може той да се използва, когато компютърът не е включен в електрическата мрежа.

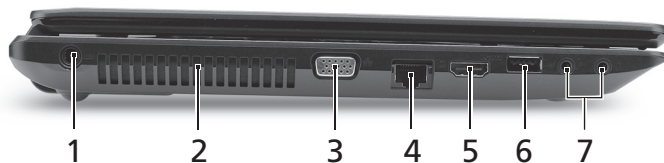

Изглед отляво



#	Икона	Обект	Описание
1		Жак за DC вход	За връзка с AC адаптер.
2		Вентилационни отвори	Позволява на компютъра да се охлажда дори и при продължителна употреба.
3		Порт за външен дисплей (VGA)	За връзка с дисплейно устройство (напр. външен монитор, LCD проектор).
4		Порт за Ethernet (RJ-45)	За връзка с мрежа, базирана на Ethernet 10/100/1000.
5		HDMI порт	Поддържа високодетаилна цифрова видео връзка.
6		USB 2.0 порт	За връзка с USB 2.0 устройства (напр. USB мишки, USB камери).
7		Жак за вход за микрофон	Приема входящ сигнал от външни микрофони.
		Жак за изход за слушалки/високоговорител	За връзка с изходни аудио устройства (напр. високоговорители, слушалки).

Изглед отдясно



#	Икона	Обект	Описание
1		USB 2.0 порт	За свързване на USB 2.0 устройства (напр. USB мишки, USB камери).
2		Оптично устройство	Вътрешно оптично устройство; чете CD или DVD.
3		Индикатор за достъп до оптичен диск	Светва, когато оптичното устройство е активно.
4		Бутон за отваряне на оптичното устройство	Изважда оптичния диск от устройството.
5		Отвор за спешно изваждане	Изважда тавата с оптичния диск, когато компютърът е изключен. Забележка: Пъхнете кламер в отвора за спешно изваждане, за да извадите тавата на оптичното устройство, докато компютърът е изключен.
6		Слот за заключващ механизъм Kensington	За връзка с Kensington-съвместим компютърен заключващ механизъм. Забележка: Увийте осигурителния кабел около неподвижен обект, като например закрепена за пода маса или дръжката на заключено чекмедже. Поставете ключалката в жлеба и завъртете ключа, за да я заключите. Има и някои модели без ключове.

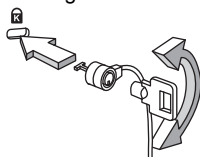

Изглед отдолу

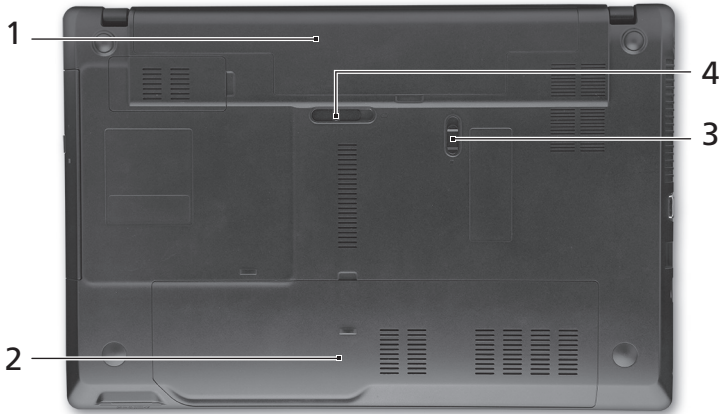

#	Икона	Обект	Описание
1		Отделение за батерия	Тук се поставя батерийният пакет на компютъра.
2		Отделение за твърдия диск	Тук се намира твърдият диск на компютъра (прикрепен с винтове).
		Отделение за памет	Тук се поставя главната памет на компютъра.
3		Придържателен механизъм на батерията	Държи батерията на мястото ѝ.
4		Езиче за освобождаване на батерията	Освобождава батерията, за да можете да я извадите.

Работна среда	<ul style="list-style-type: none"> Температура: <ul style="list-style-type: none"> Работна: 5°C до 35°C За съхранение: -20°C до 65°C Влажност (некондензирана): <ul style="list-style-type: none"> Работна: 20% до 80% За съхранение: 20% до 80%
---------------	--

TravelMate 5740/5740Z/5340 seeria

Lühijuhend

© 2010 Kõik õigused kaitstud.

TravelMate 5740/5740Z/5340 seeria lühijuhend
Originaalväljaanne: 03/2010

TravelMate 5740/5740Z/5340 seeria sülearvuti

Mudeli number: _____

Seerianumber: _____

Ostukuupäev: _____

Ostukoht: _____

Kõigepealt tähtsamad asjad

Täname Teid selle eest, et valisite oma kaasaskantavaks arvutiks Acer'i sülearvuti.

Teie teejuhid

Et aidata Teil kasutada oma Acer'i sülearvutit, oleme loonud komplekti juhiseid:

Kõigepealt aitab **seadistuse poster** Teil alustada oma arvuti häälestamist.

TravelMate seeria üldkasutusjuhend sisaldab kõigile TravelMate tooteseeria mudelitele kohalduvat kasulikku teavet. See katab põhilisi teemasid nagu klaviatuuri kasutamine, heli jne. Palume mõista, et tulenevalt nende loomusest viitab allpool mainitud **AcerSystemi kasutaja teatmik** aeg-ajalt funktsioonidele või omadustele, mis on ainult teatud seeria mudelitel, kuid mitte tingimata teie ostetud mudelil. Sellised juhtumid on tekstis märgitud väljenditega nagu „ainult teatud mudelitel”.

Antud **Lühijuhend** tutvustab Teile uue arvuti põhilisi omadusi ja funktsioone.

Kui soovite rohkem teada saada, kuidas arvuti aitab Teil produktiivsem olla, vaadake **AcerSystemi kasutusjuhendit**. Teatmik sisaldab täpsemat informatsiooni teemadel nagu süsteemiütilidid, andmete taastamine, laiendusvõimalused ja probleemide lahendamine. Sellele lisaks sisaldab see garantiinformatsiooni ning sülearvuti kohta kehtivaid üldiseid regulatsioone ja ohutuseeskirju. See on saadaval PDF-formaadis (Portable Document Format) ning on laetud Teie sülearvutisse. Juhised selle avamiseks:

- 1 Klõpsake **Start > Kõik programmid > AcerSystem**.
- 2 Klõpsake real **AcerSystemi kasutusjuhend**.





Märkus: Faili vaatamiseks on vaja Adobe Reader'it. Kui Adobe Reader pole arvutisse installeeritud, käivitab **AcerSystemi kasutaja teatmik**ile kõigepealt Adobe Reader'i installeerimisprogrammi. Installeerimise lõpetamiseks järgige ekraanil olevaid juhiseid. Juhiseid Adobe Reader'i kasutamiseks leiate menüüst **Spikker ja tugi**.

Teie Acer sülearvuti ülevaade

Kui olete oma arvuti häälestanud postril **Alustuseks...** kujutatud viisil, lubage meil teile tutvustada teie uut Acer sülearvutit.

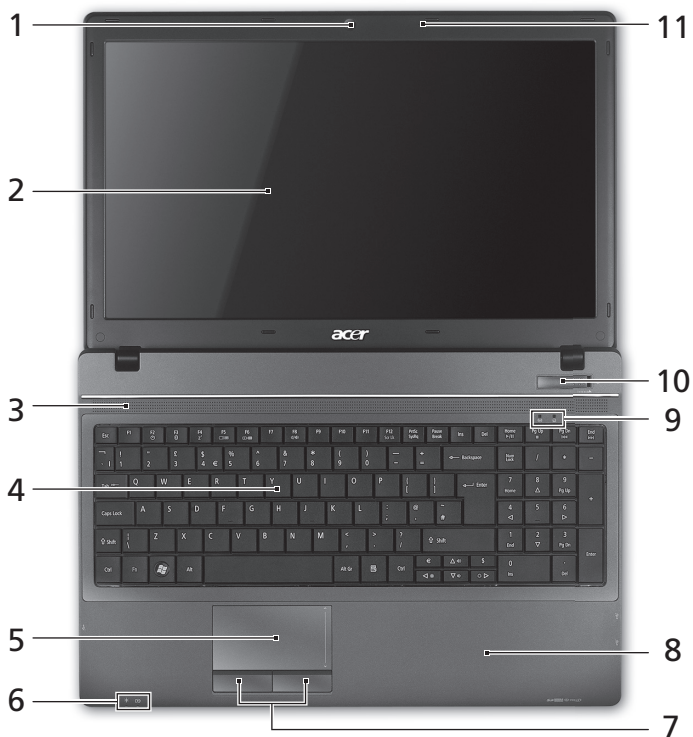
Pealtvaade













#	Ikoon	Objekt	Kirjeldus
1		Acer Crystal Eye veebikaamera	Veebikaamera videosuhtluseks (ainult teatud mudelitel).
2		Kuvariekraan	Teise nimega vedelkristallekraan (LCD), kuvab arvuti pilti (Mudelite konfiguratsioon võib erineda).
3		Kõlarid	Eesmine vasakpoolne ja eesmine parempoolne kõlar toodavad stereo heli.
4		Klaviatuur	Andmete sisestamiseks arvutisse.
5		Puuteplaat	Puutetundlik osutusseadis, mis töötab arvutihiirena.
6		Vooluindikaator ¹	Näitab arvuti olekut.
		Akuindikaator ¹	Näitab arvuti aku olekut. 1. Laadimine: Kui akut laetakse, on tuli kollakat värvi. 2. Täielikult laetud: Kui arvuti on vooluvõrgus, on tuli sinist värvi.
7		Klõpsunupud (vasem ja parem)	Vasak ja parem nupp funktsioneerivad vasaku ja parema hiirenupuna.
8		Randmetugi	Mugav toetusala, kuhu saate arvutit kasutades toetada oma käsi.
9		HDD	Näitab kõvaketta aktiivsust.
		Ühenduse indikaator	Näitab arvuti traadita ühenduse seadme olekut.
10		Toitelüliti	Arvuti sisse- ja väljalülitamiseks.
11		Mikrofon	Sisseehitatud mikrofon heli salvestamiseks.

1. Esipaneelil asuvad indikaatorid on nähtavad ka siis, kui arvuti kaas on suletud.

Kiirklahvid



Arvutil on enamiku seadete jaoks (nt ekraani heledus, heliväljund) olemas kiirklahvid ja klahvikombinatsioonid.

Kiirklahvide aktiveerimiseks vajutage ning hoidke enne teise kombinatsiooni kuuluva klahvi vajutamist all klahvi **<Fn>**.

Kiirklahv	Icoon	Funktsioon	Kirjeldus
<Fn> + <F3>		Kommunikatsioon	Aktiveerib/desaktiveerib arvuti sideseadmed. (Sideseadmed võivad vastavalt konfiguratsioonile erineda.)
<Fn> + <F4>		Unerežiim	Lülitab arvuti unerežiimi.
<Fn> + <F5>		Ekraani valik	Lülitab ekraanipildi kuvaekraanile, välisele ekraanile (kui see on ühendatud) või mõlemale.
<Fn> + <F6>		Ekraan välja	Lülitab ekraani tagantvalgustuse energia säästmiseks välja. Tagasipöördumiseks vajutage suvalisele klahvile.
<Fn> + <F7>		Puuteplaadi lüliti	Puuteplaadi sisse- ja väljalülitamiseks.
<Fn> + <F8>		Kõlarilüliti	Lülitab kõlarid sisse või välja.
<Fn> + <▲>		Helitugevus üles	Tõstab helitugevust.
<Fn> + <▼>		Helitugevus alla	Langetab helitugevust.
<Fn> + <▶>		Heledus üles	Suurendab ekraani heledust.
<Fn> + <◀>		Heledus alla	Vähendab ekraani heledust.

Suletud eestvaade



#	Icoon	Objekt	Kirjeldus
1		Vooluindikaator ¹	Näitab arvuti olekut.
		Akuindikaator ¹	Näitab arvuti aku olekut. 1. Laadimine: Kui akut laetakse, on tuli kollakat värvi. 2. Täielikult laetud: Kui arvuti on vooluvõrgus, on tuli sinist värvi.
2		Mitu-ühes kaardilugeja	Võtab vastu Secure Digital (SD), MultiMediaCard (MMC), Memory Stick (MS), Memory Stick PRO (MS PRO) ja xD-Picture kaarte (xD). Märkus: Kaardi eemaldamiseks/ paigaldamiseks vajutage sellele. Korraga saab töötada ainult üks kaart.







Tagantvaade

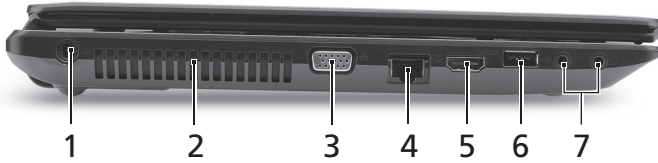

#	Icoon	Objekt	Kirjeldus
1		Aku	Annab arvutile voolu, kui seda kasutatakse vooluvõrku lülitamata.



Vaade vasakult



#	Ikon	Objekt	Kirjeldus
1		Alalisvoolusisendi pistik	Vahelduvvooluadapteri (toiteploki) ühendamiseks.
2		Ventilatsiooniavad	Võimaldavad arvutil püsida jahedana ka pärast pikaajalist kasutamist.
3		Välisekraani (VGA) port	Kuvaseadme (nt välise monitori või LCD-projektori) ühendamiseks.
4		Etherneti (RJ-45) port	Ethernet 10/100/1000-põhise võrguga ühendamiseks.
5		HDMI-port	Toetab kõrglahutusega digitaalvideoühendusi.
6		USB 2.0 port	USB 2.0 seadmete ühendamiseks (nt USB-hiir või USB-kaamera).
7		Mikrofonipesa	Võtab vastu sisendheli välisest mikrofonist.
		Kõrvaklappide/ kõlarite/heliväljundi pistik	Heliväljundseadmete ühendamiseks (nt kõlarid, kõrvaklapid).

Vaade paremalt





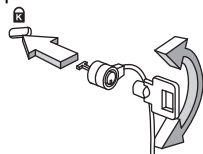

#	Ikoon	Objekt	Kirjeldus
1		USB 2.0 port	USB 2.0 seadmete ühendamiseks (nt USB-hiir või USB-kaamera).
2		Optiline seade	Sisemine optiline seade; loeb CD-sid või DVD-sid.
3		Optilise ketta lugemise indikaator	Süttib, kui optiline seade on aktiivne.
4		Optilise seadme väljastusnupp	Väljastab optilise ketta seadmest.
5		Hädaväljastusava	Avab optilise seadme sahtli, kui arvuti on välja lülitatud. Märkus: Optilise seadme avamiseks siis, kui arvuti on välja lülitatud, lükake hädaväljastusavasse kirjaklamber.
6		Kensington-luku pesa	Kensington-tüüpi arvuti turvaluku ühendamiseks. Märkus: Vedage arvuti turvaluku kaabel ümber liikumatu objekti, näiteks laua või lukustatud sahtli käepideme. Lükake lukk avasse ning keerake luku sulgemiseks võtit. Saadaval on ka võtmeta mudelid.

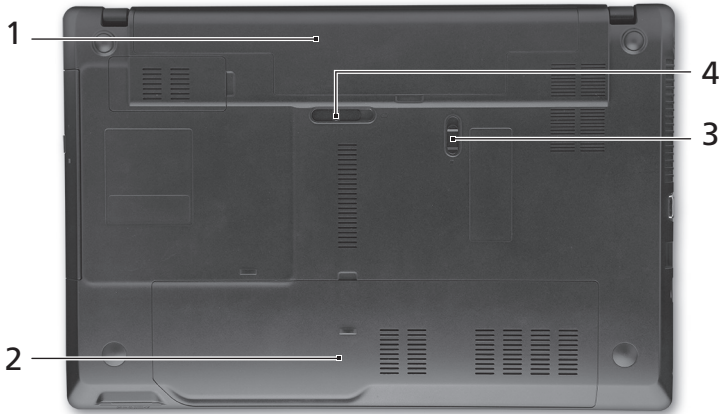

Põhjavaade



#	Ikon	Objekt	Kirjeldus
1		Akuseksioon	Siin asuvad arvuti akud.
2		Kõvakettaseksioon	Siin asub arvuti kõvaketas (kinnitatud kruvidega).
		Mälusahtel	Siin asub arvuti põhimälu.
3		Akulukk	Lukustab aku kohale.
4		Aku vabastamise riiv	Vabastab aku, et seda saaks välja võtta.

Keskkond

- Temperatuur:
 - Töötamiseks sobiv: 5°C kuni 35°C
 - Sobimatu: -20°C kuni 65°C
- Niiskus (mittekondenseeruv):
 - Töötamiseks sobiv: 20% kuni 80%
 - Sobimatu: 20% kuni 80%

TravelMate 5740/5740Z/5340 sērija

Ātrais ceļvedis

© 2010 Visas tiesības aizsargātas.

TravelMate 5740/5740Z/5340 sērijas ātrais ceļvedis
Oriģinālizdevums: 03/2010

TravelMate 5740/5740Z/5340 sērijas piezīmjdators

Modeļa numurs: _____

Sērijas numurs: _____

Pirkuma datums: _____

Pirkuma vieta: _____

Galvenais vispirms

Mēs vēlamies jums pateikties, ka esat izvēlējies Acer piezīmjdatoru, lai nodrošinātu savas mobilās skaitļošanas vajadzības.

Jūsu rokasgrāmatas

Lai palīdzētu jums lietot Acer piezīmjdatoru, esam sagatavojuši rokasgrāmatu komplektu:

Pirmkārt, **uzstādīšanas attēls** jums palīdz sagatavot datoru darbam.

TravelMate vispārējais lietotāja ceļvedis satur noderīgu informāciju, kas attiecas uz visiem TravelMate produktu sērijas modeļiem. Tas aptver pamata tematiku, tādu kā tastatūras un audio izmantošana utt. Lūdzu, saprotiet, ka **AcerSystem lietotāja ceļvedis**, kas pieminēts turpmāk, tā būtības dēļ laiku pa laikam attiecas uz funkcijām vai līdzekļiem, kas piemīt tikai noteiktiem sērijas modeļiem, bet ne obligāti modelim, ko esat iegādājies. Šādi gadījumi tekstā ir apzīmēti ar vārdiem „tikai noteiktiem modeļiem”.

Šis **Ātrais ceļvedis** sniedz ieskatu par jūsu jaunā datora galvenajiem līdzekļiem un funkcijām. Lai uzzinātu vairāk, kā jūsu dators jums var palīdzēt būt vēl produktīvākam, lūdzu, skatiet **AcerSystem lietotāja ceļvedi**. Šajā ceļvedī ir detalizēta informācija par tādām tēmām kā sistēmas utilitātas, datu atkopšana, paplašināšanas opcijas un problēmu novēršana. Bez tam tajā ir iekļauta informācija par garantijām un piezīmjdatora lietošanas vispārīgas regulas un drošības paziņojumi. Tas ir pieejams PDF (Portable Document Format - portatīvā dokumenta formāts) formātā un ir iepriekš ielādēts jūsu piezīmjdatorā. Veiciet šīs darbības, lai tam piekļūtu:

- 1 noklikšķiniet uz **Start (Sākt) > All Programs (Visas programmas) > AcerSystem**.
- 2 Noklikšķiniet uz **AcerSystem User Guide (AcerSystem lietotāja ceļvedis)**.



.....





Piezīme: lai skatītu failu, nepieciešama programma Adobe Reader. Ja jūsu datorā nav instalēta programma Adobe Reader, pirmo reizi noklikšķinot uz **AcerSystem User Guide (AcerSystem lietotāja ceļvedis)**, automātiski tiks palaista programmas Adobe Reader instalēšana. Lai pabeigtu instalēšanu, izpildiet ekrānā redzamos norādījumus. Lai iegūtu norādījumus, kā lietot programmu Adobe Reader, piekļūstiet izvēlei **Help and Support** (Palīdzība un atbalsts).

Acer piezīmjdatora pārskats

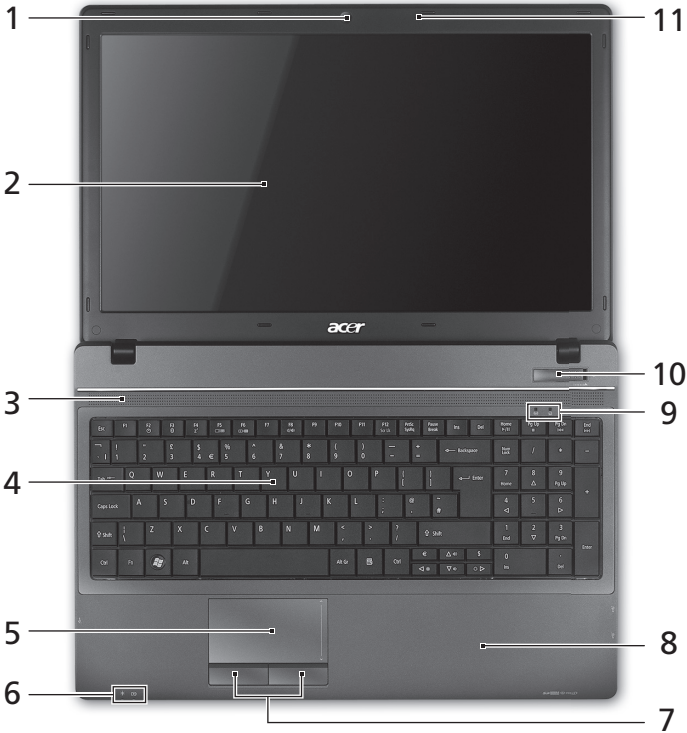
Ja esat sagatavojis datoru darbam, kā redzams attēlā **Tikko sākušajiem...**, ļaujiet mums jūs iepazīstināt ar jūsu jauno Acer piezīmjdatoru.

Skats no augšpuses











#	Ikona	Elements	Apraksts
1		Acer Crystal Eye tīmekļa kamera	Tīmekļa kamera videosakariem (tikai noteiktiem modeļiem).
2		Displeja ekrāns	Saukts arī par šķidro kristālu displeju (LCD); rāda datora izvadi (modeļu konfigurācija var atšķirties).
3		Skaļruņi	Priekšējais kreisais un priekšējais labais skaļrunis nodrošina stereo audio izvadi.
4		Tastatūra	Datu ievadīšanai datorā.
5		Skārienpanelis	Skārienjutīga rādītājierīce, kas darbojas kā datora pele.
6		Jaudas indikators ¹	Norāda datora barošanas statusu.
		Akumulatora indikators ¹	Norāda datora akumulatora statusu. 1. Uzlāde: Indikators ir oranžā krāsā, akumulatoram lādējoties. 2. Pilnībā uzlādēts: Datoram darbojoties no maiņstrāvas, indikators ir zils.
7		Klikšķināmas pogas (kreisā un labā)	Kreisā un labā poga darbojas tāpat kā peles kreisā un labā poga.
8		Plaukstu atbalsta zona	Ērta atbalsta zona jūsu rokām, kad lietojat datoru.
9		Cietais disks	Norāda, ka cietais disks ir aktīvs.
		Sakaru indikators	Norāda datora bezvadu savienojamās ierīces statusu.
10		Barošanas slēdzis	Ieslēdz un izslēdz datoru.
11		Mikrofons	Iekšējais mikrofons skaņas ierakstīšanai.

1. Priekšējā paneļa indikatori ir redzami pat tad, kad datora vāks ir cieši aizvērts.

Ātrie taustiņi

Lai piekļūtu lielākajai daļai datora vadības funkciju, piemēram, ekrāna spilgtuma un skaļuma regulēšanai, tiek izmantoti datora ātrie taustiņi jeb taustiņu kombinācijas.

Lai aktivizētu ātros taustiņus, nospiediet un turiet taustiņu **<Fn>**, tad nospiediet ātrā taustiņa kombinācijas otru taustiņu.

Ātrais taustiņš	Ikona	Funkcija	Apraksts
<Fn> + <F3>		Sakari	Iespējo/atspējo datora sakaru ierīces. (Sakaru ierīces var atšķirties atkarībā no konfigurācijas.)
<Fn> + <F4>		Miega režīms	Pārslēdz datoru miega režīmā.
<Fn> + <F5>		Displeja pārslēgšana	Pārslēdz displeja izvadi starp displeja ekrāna un ārējo monitoru (ja tas ir pievienots), vai rāda izvadi abos.
<Fn> + <F6>		Izslēgt displeju	Enerģijas taupīšanas nolūkā izslēdz displeja ekrāna pretgaismu. Lai atjaunotu pretgaismu, nospiediet jebkuru taustiņu.
<Fn> + <F7>		Skārienpaneļa pārslēgšana	Ieslēdz un izslēdz skārienpaneli.
<Fn> + <F8>		Skaļruņu pārslēgšana	Ieslēdz un izslēdz skaļruņus.
<Fn> + <Δ>		Skaļāk	Palielina skaņas skaļumu.
<Fn> + <▽>		Klusāk	Samazina skaņas skaļumu.
<Fn> + <▷>		Spilgtāk	Palielina ekrāna spilgtumu.
<Fn> + <◁>		Blīvāk	Samazina ekrāna spilgtumu.

Skats no priekšpuses aizvērtā veidā



#	Ikona	Elements	Apraksts
1		Jaudas indikators ¹	Norāda datora barošanas statusu.
		Akumulatora indikators ¹	Norāda datora akumulatora statusu. 1. Uzlāde: Indikators ir oranžā krāsā, akumulatoram lādējoties. 2. Pilnībā uzlādēts: Datoram darbojoties no maiņstrāvas, indikators ir zils.
2		Karšu lasītājs "Vairāki vienā"	Pieņem datu nesējus Secure Digital (SD), MultiMediaCard (MMC), Memory Stick (MS), Memory Stick PRO (MS PRO) un xD-Picture Card (xD). Piezīme: Nospiediet, lai izņemtu/instalētu karti. Vienlaikus var lietot tikai vienu karti.



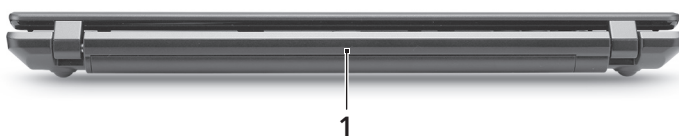



Skats no aizmugures

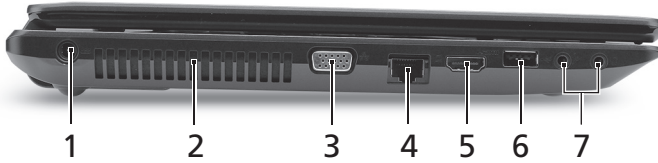

#	Ikona	Elements	Apraksts
1		Akumulators	Nodrošina datora barošanu, lai to varētu izmantot atvienotu.



Skats no kreisās puses



#	Ikona	Elements	Apraksts
1		Līdzstrāvas ieejas ligzda	Šeit pieslēdz maiņstrāvas adapteru.
2		Ventilācijas atveres	Neļauj datoram sakarst pat pēc ilgstošas lietošanas.
3		Ārējā displeja (VGA) ports	Šeit pieslēdz displeja ierīci (piemēram, ārēju monitoru, LCD projektoru).
4		Ethernet (RJ-45) ports	Šeit pieslēdz Ethernet 10/100/1000 tīkla vadu.
5		HDMI ports	Atbalsta augstas kvalitātes ciparu video savienojumus.
6		USB 2.0 ports	Šeit pieslēdz USB 2.0 ierīces (piemēram, USB peli, USB kameru).
7		Mikrofona ieejas ligzda	Pieņem ievadi no ārējiem mikrofoniem.
		Austiņu/skaļruņu/ līnijas izejas ligzda	Šeit pieslēdz audio līnijas izejas ierīces (piemēram, skaļruņus, austiņas).

Skats no labās puses



#	Ikona	Elements	Apraksts
1		USB 2.0 ports	Šeit pieslēdz USB 2.0 ierīces (piemēram, USB peli vai USB kameru).
2		Optiskais diskdzinis	Iekšējais optiskais diskdzinis; pieņem CD vai DVD diskus.
3		Optiskā diska piekļuves indikators	Iedegas, kad optiskais diskdzinis ir aktīvs.
4		Optiskā diska izstumšanas poga	Izstumj no diskdziņa optisko disku.
5		Ārkārtas diska izņemšanas caurums	Izstumj optiskā diskdziņa paliktni, kad dators ir izslēgts. Piezīme: Lai izstumtu optiskā diskdziņa paliktni, kad dators ir izslēgts, iespiediet ārkārtas diska izņemšanas caurumā papīra saspraudi.
6		Kensingtona atslēgas slots	Šeit pieslēdz Kensingtona atslēgu datora drošībai. Piezīme: Aplieciet datora drošības slēdzenes vadu ap nekustīgu priekšmetu, piemēram, galdu vai aizslēgtas atvilktnes rokturi. Ielieciet aizslēgu ierobā un pagrieziet atslēgu, lai nofiksētu slēdzeni. Pieejami arī daži modeļi bez atslēgas.

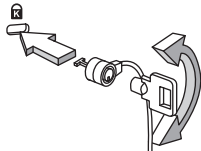

Skats no apakšpuses

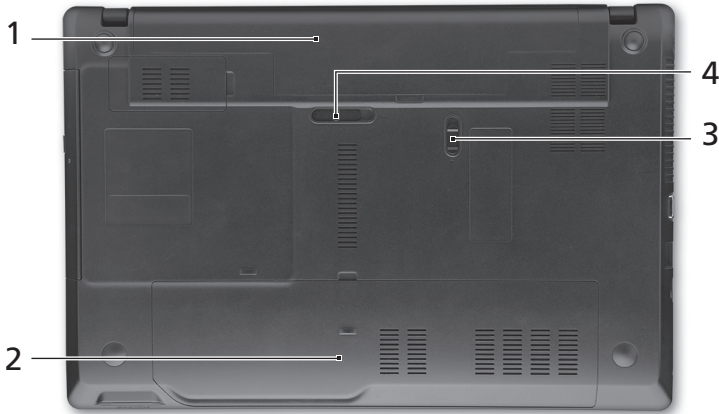

#	Ikona	Elements	Apraksts
1		Akumulatora nodalījums	Šeit ievieto datora akumulatoru.
2		Cietā diska nodalījums	Šeit atrodas datora cietais disks (nostiprināts ar skrūvēm).
		Atmiņas nodalījums	Šeit atrodas datora pamatatmiņa.
3		Akumulatora fiksators	Nofiksē akumulatoru.
4		Akumulatora atbrīvošanas slēdzis	Atbrīvo akumulatoru, lai to varētu izņemt.

Vide

- Temperatūra:
 - Ieslēgtā stāvoklī: No 5°C līdz 35°C
 - Izslēgtā stāvoklī: No -20°C līdz 65°C
- Mitrums (bez kondensācijas):
 - Ieslēgtā stāvoklī: No 20% līdz 80%
 - Izslēgtā stāvoklī: No 20% līdz 80%

TravelMate 5740/5740Z/5340 seriju

Trumpa instrukcija

© 2010 Visos teisės saugomos.

TravelMate 5740/5740Z/5340 serijų Trumpa instrukcija
Pirmasis leidimas: 03/2010

TravelMate 5740/5740Z/5340 serijų nešiojamasis kompiuteris

Modelio numeris: _____

Serijos numeris: _____

Pirkimo data: _____

Pirkimo vieta: _____

Dalykai, kuriuos reikia atlikti pirmiausia

Leiskite padėkoti, kad pasirinkote „Acer“ nešiojamąjį kompiuterį – tikimės Jūsų nenuvilti ir užtikrinti visus nešiojamojo kompiuterio teikiamus privalumus.

Instrukcijos Jums

Tam, kad palengvintume Jums naudojimąsi „Acer“ kompiuteriu, parengėme kelias instrukcijas:

Pirmoji yra **sąrankos plakatas** - ši informacija padės pirmosiomis kompiuterio naudojimo minutėmis.

„TravelMate“ serijos bendrojoje naudojimo instrukcijoje pateikiama naudinga informacija apie visų „TravelMate“ gaminių serijos modelių kompiuterius. Jis apima bendruosius klausimus, kaip, pvz. klaviatūros ir audio sistemos naudojimas ir t.t. Prašome atkreipti dėmesį į tai, jog dėl savo pobūdžio **AcerSystem User Guide**, kuris bus minimas toliau, kartais bus aptariamoms funkcijoms ar ypatybėms, būdingoms tik konkrečioms šios serijos modeliams ir nebūtinai tam modeliui, kurį jūs įsigijote. Tokiais atvejais atitinkamose teksto vietose yra priedašais „tik tam tikruose modeliuose“.

Šioje **Trumpoje instrukcijoje** pateikiama informacija apie pagrindines Jūsų įsigyto kompiuterio savybes ir funkcijas. Išsamesnės informacijos apie tai, kaip padaryti kompiuterį produktyvesniu, rasite **AcerSystem User Guide**. Šioje instrukcijoje išsamiai aprašoma tokia informacija, kaip sisteminiai failai, duomenų atstatymas, kompiuterio galimybių praplėtimas ir gedimų diagnostika. Be to, šioje instrukcijoje yra ir garantinė informacija, bendrieji reikalavimai ir su sauga susiję įspėjimai. Ši instrukcija yra „Portable Document Format (PDF)“ formate ir ji jau bus kompiuteryje. Jei norite peržiūrėti šį gidą:

- 1 Spauskite **Start (pradėti) > All Programs (visos programos) > AcerSystem**.
- 2 Spauskite **AcerSystem User Guide**.



.....

Pastaba: Failo peržiūrai reikės „Adobe Reader“. Jei kompiuteryje nėra „Adobe Reader“, paspaudus ant **AcerSystem User Guide** bus pirmiausiai paleistas „Adobe Reader“ įdiegimas. Vadovaukitės ekrane esančiomis instrukcijomis įdiegimo užbaigimui. Instrukcijų dėl „Adobe Reader“ naudojimosi ieškokite „**Help and Support**“ [**Žinynas ir pagalba**] meniu.

Ekskursija po jūsų Acer nešiojamąjį kompiuterį

Atlikus kompiuterio sąranką kaip parodyta **Pradedantiesiems...** plakate, leiskite jus supažindinti su jūsų naujuoju Acer nešiojamuoju kompiuteriu.

Vaizdas iš viršaus

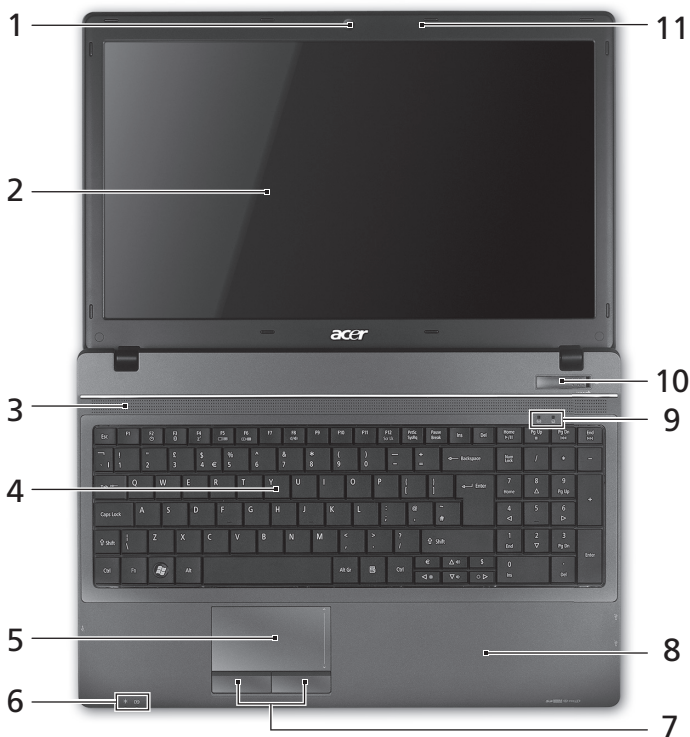











#	Piktograma	Objektas	Aprašymas
1		Acer Crystal Eye interneto kamera	Interneto kamera vaizdinei komunikacijai (tik tam tikruose modeliuose).
2		Ekranas	Taip pat vadinamas skystųjų kristalų ekranu (angl. Liquid-Crystal Display (LCD)), jame pateikiamas kompiuterio rodomas vaizdas (Konfigūravimo tvarka gali kisti priklausomai nuo modelio).
3		Garsiakalbiai	Priekinis kairysis ir dešinysis garsiakalbiai transliuoja stereo garsą.
4		Klaviatūra	Skirta duomenų įvedimui į kompiuterį.
5		Liečiamasis laukelis	Lietimui jautrus įrenginys, veikiantis kaip kompiuterio pelė.
6		Maitinimo indikatorius ¹	Nurodo kompiuterio energijos sistemos būklę.
		Baterijos indikatorius ¹	Nurodo kompiuterio baterijos būklę. 1. Kraunasi: Kraunantis baterijai lemputė dega gintaro spalva. 2. Pilnai pakrauta: Dirbant iš kintamos srovės (AC) tinklo lemputė dega mėlynai.
7		Pelės klavišai (kairysis ir dešinysis)	Kairysis ir dešinysis klavišai veikia kaip kairysis ir dešinysis pelės mygtukai.
8		Atrama delnui	Patogi atramos vieta jūsų rankoms naudojimosi kompiuteriu metu.
9		Kietojo disko (HDD)	Nurodo ar kietasis diskas yra naudojamas (į jį rašoma ar skaitoma).
		Komunikacijos indikatorius	Nurodo kompiuterio belaidžio ryšio įtaiso būklę.
10		Maitinimo jungiklis	Įjungia ir išjungia kompiuterį.
11		Mikrofonas	Vidinis mikrofonas garso įrašymui.

1. Priekinio pulto indikatoriai matomi ne tada, kai kompiuterio viršus yra uždarytas.

Greitieji klavišai

Kompiuteryje įrengti greitieji klavišai ar numatytos klavišų kombinacijos, leidžiančios valdyti daugelį kompiuterio funkcijų, tokių kaip ekrano ryškumas ar garsiakalbių garsas.

Norėdami pasinaudoti greitaisiais klavišais, prieš spausdami bet kokią greitųjų klavišų kombinaciją nuspauskite ir laikykite klavišus <Fn>.

Greitasis klavišas	Piktograma	Funkcija	Aprašymas
<Fn> + <F3>		Komunikacija	Ijungia/išjungia kompiuterio komunikacijos prietaisus. (Komunikacijos prietaisai gali skirtis priklausomai nuo konfigūracijos.)
<Fn> + <F4>		Sustabdyti	Ijungia hibernacijos (kompiuterio sustabdymo) režimą.
<Fn> + <F5>		Ekrano perjungimas	Perjungia kompiuterio rodomą vaizdą iš kompiuterio monitoriaus į išorinį monitorių (jei prijungtas) ir atvirkščiai.
<Fn> + <F6>		Ekrano išjungimas	Energijos taupymo tikslais išjungia ekraną. Norint vėl įjungti spauskite bet kurį klavišą.
<Fn> + <F7>		Lietimui jautraus laukelio jungiklis	Ijungia ir išjungia lietimui jautrų laukelį.
<Fn> + <F8>		Garsiakalbio jungiklis	Išjungia ir įjungia garsiakalbius.
<Fn> + <Δ>		Padidinti garsą	Padidina kompiuterio audio sistemos garsą.
<Fn> + <▽>		Sumažinti garsą	Sumažina kompiuterio audio sistemos garsą.
<Fn> + <▷>		Padidinti ryškumą	Padidina ekrano ryškumą.
<Fn> + <◁>		Sumažinti ryškumą	Sumažina ekrano ryškumą.

Uždaryto kompiuterio vaizdas iš priekio



#	Piktograma	Objektas	Aprašymas
1		Maitinimo indikatorius ¹	Nurodo kompiuterio energijos sistemos būklę.
		Baterijos indikatorius ¹	Nurodo kompiuterio baterijos būklę. 1. Kraunasi: Kraunantis baterijai lemputė dega gintaro spalva. 2. Pilnai pakrauta: Dirbant iš kintamos srovės (AC) tinklo lemputė dega mėlynai.
2		„Multi-in-1“ atminties kortelių skaitytuvas	Skaito Secure Digital (SD), MultiMediaCard (MMC), Memory Stick (MS), Memory Stick PRO (MS PRO), xD-Picture Card (xD) tipų atminties korteles. Pastaba: Spauskite norėdami įdėti/išimti kortelę. Vienu metu galima naudotis tik viena kortele.







Vaizdas iš užpakalio

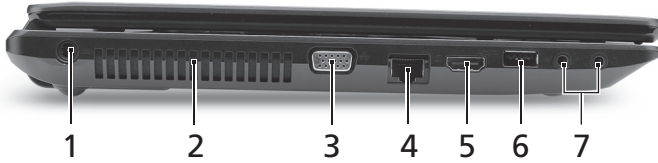

#	Piktograma	Objektas	Aprašymas
1		Baterija	Suteikia maitinimą kompiuteriui, kai jis naudojamas atjungtas nuo tinklo.



Vaizdas iš kairės



#	Piktograma	Objektas	Aprašymas
1		Nuolatinės srovės (DC) kištuko lizdas	Skirtas prijungti kintamos srovės (AC) adapteriui.
2		Ventiliacijos angos	Neleidžia kompiuteriui perkaisti net ir po ilgo naudojimo.
3		Išorinio ekrano (VGA) lizdas	Skirtas prijungti papildomą monitorių (pvz. išorinį monitorių, LCD projektorių).
4		Ethernet (RJ-45) lizdas	Skirtas prisijungti prie Ethernet 10/100/1000 tipo tinklo.
5		HDMI lizdas	Skirtas prijungti didelės raiškos skaitmeniniams vaizdo prietaisams.
6		USB 2.0 lizdas	Skirtas USB 2.0 įrenginiams (pvz., USB pelė, USB kamera) prijungti.
7		Mikrofono kištuko lizdas	Skirtas prijungti išorinį mikrofoną.
		Ausinių/garsiakalbio/linijinio išėjimo kištukas	Skirtas išoriniams linijiniams audio prietaisams (pvz. garsiakalbiams, ausinėms) pajungti.

Vaizdas iš dešinės





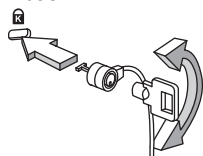

#	Piktograma	Objektas	Aprašymas
1		USB 2.0 lizdas	Skirtas USB 2.0 įrenginiams (pvz., USB pelė, USB kamera) prijungti.
2		Optinių diskų įrenginys	Vidinis optinių diskų įrenginys; skaito CD arba DVD.
3		Optinio disko darbo indikatorius	Dega kai optinių diskų įrenginys dirba.
4		Optinių diskų išstūmimo mygtukas	Atidaro optinių diskų įrenginio dureles.
5		Avarinio atidarymo anga	Atidaro optinių diskų įrenginio dureles kai kompiuteris yra išjungtas. Pastaba: Norėdami esant išjungtam kompiuteriui atidaryti optinių diskų įrenginio dureles, į avarinio atidarymo angą įkiškite sąvaržėlę.
6		Kensington spynos lizdas	Skirtas užfiksuoti Kensington tipo kompiuterio užraktui. Pastaba: Kompiuterio užrakto kabelį apvyniokite aplink nejudamą objektą, pvz. stalą arba užrakinto stalčiaus rankeną. Įkiškite užraktą į įpjovą ir pasukite raktelį, kad užsirakintų. Siūloma ir modelių be raktelių.

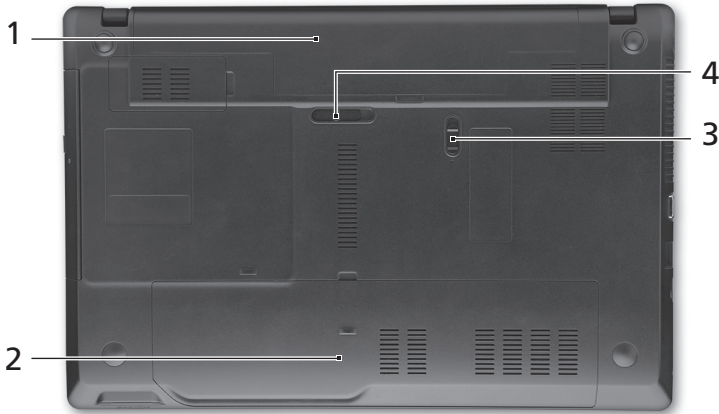

Vaizdas iš apačios



#	Piktograma	Objektas	Aprašymas
1		Baterijos lizdas	Skirtas montuoti kompiuterio baterijai.
2		Kietųjų diskų lizdas	Montuojamas kietasis diskas (įtvirtintas varžtais).
		Operatyviosios atminties lizdas	Montuojama pagrindinė kompiuterio atmintis.
3		Baterijos užraktas	Fiksuoja įdėtą bateriją darbinėje padėtyje.
4		Baterijos fiksatorius	Atpalaiduoja baterijos fiksavimą, leidžia ją išimti.

Aplinka

- Temperatūra:
 - Darbinė: Nuo 5°C iki 35°C
 - Saugojimo: Nuo -20°C iki 65°C
- Drėgmė (be kondensacijos):
 - Darbinė: Nuo 20% iki 80%
 - Saugojimo: Nuo 20% iki 80%

Σειρά TravelMate 5740/5740Z/ 5340

Γρήγορος οδηγός

© 2010 Με την επιφύλαξη κάθε νόμιμου δικαιώματος.

Γρήγορος οδηγός σειράς TravelMate 5740/5740Z/5340
Αρχική Έκδοση: 03/2010

Φορητό PC σειράς TravelMate 5740/5740Z/5340

Αριθμός Μοντέλου: _____

Σειριακός Αριθμός: _____

Ημερομηνία Αγοράς: _____

Τόπος Αγοράς: _____

Πρώτα από όλα

Θα επιθυμούσαμε να σας ευχαριστήσουμε που επιλέξατε το φορητό υπολογιστή της Acer με σκοπό την αντιμετώπιση των αναγκών σας για φορητό υπολογιστή.

Οι οδηγοί σας

Για να σας βοηθήσουμε στη χρήση του φορητού υπολογιστή της Acer, έχουμε σχεδιάσει ένα σετ εγχειριδίων χρήσης:

Πρώτα απ' όλα, η **αφίσσα εγκατάστασης** σας βοηθά να ξεκινήσετε με την εγκατάσταση του υπολογιστή σας.

Ο **Γενικός Οδηγός Χρήσης Σειράς TravelMate** περιέχει χρήσιμες πληροφορίες που ισχύουν για όλα τα μοντέλα της σειράς προϊόντων TravelMate. Καλύπτει βασικά θέματα όπως τη χρήση του πληκτρολογίου και τον ήχο κ.λ.π. Παρακαλούμε σημειώστε ότι λόγω της φύσης του ο **Οδηγός Χρήσης AcerSystem** που αναγράφεται πιο κάτω αναφέρεται περιστασιακά σε λειτουργίες ή δυνατότητες που αφορούν ορισμένα μόνο μοντέλα της σειράς, αλλά όχι απαραίτητα στο μοντέλο που προμηθευτήκατε. Αυτές οι περιπτώσεις επισημαίνονται στο κείμενο με τη φράση "ορισμένα μοντέλα μόνο".

Αυτός ο **Γρήγορος οδηγός** παρουσιάζει τις βασικές δυνατότητες και λειτουργίες του νέου σας υπολογιστή. Για περισσότερες πληροφορίες όσον αφορά τον τρόπο με τον οποίο ο υπολογιστής μπορεί να σας βοηθήσει να αυξήσετε την παραγωγικότητά σας, ανατρέξτε στον **AcerSystem User's Guide**. Ο οδηγός αυτός περιλαμβάνει λεπτομερείς πληροφορίες σχετικά με θέματα όπως τα βοηθητικά προγράμματα του συστήματος, την επαναφορά δεδομένων, τις επιλογές επέκτασης και την αντιμετώπιση προβλημάτων. Επιπλέον, περιλαμβάνει πληροφορίες σχετικά με την εγγύηση καλής λειτουργίας και τους γενικούς κανονισμούς όπως και τις προειδοποιήσεις ασφαλείας για το φορητό υπολογιστή. Διατίθεται σε μορφή Portable Document Format (PDF) και έχει προ-εγκατασταθεί στο φορητό υπολογιστή σας. Ακολουθήστε τα επόμενα βήματα για την πρόσβαση σε αυτόν.

- 1 Κάντε κλικ στο **Έναρξη > Όλα τα προγράμματα > AcerSystem**.
- 2 Κάντε κλικ στην επιλογή **AcerSystem User's Guide**.





Σημείωση: Για να δείτε το αρχείο θα πρέπει να έχετε εγκαταστήσει το πρόγραμμα Adobe Reader. Αν δεν είναι εγκατεστημένο το Adobe Reader στον υπολογιστή σας, κάνοντας κλικ στην επιλογή **AcerSystem User's Guide** θα πραγματοποιηθεί εκτέλεση του προγράμματος εγκατάστασης του Adobe Reader πρώτα. Ακολουθήστε τις οδηγίες στην οθόνη για να ολοκληρώσετε την εγκατάσταση. Για οδηγίες σχετικά με το πώς να χρησιμοποιήσετε το πρόγραμμα Adobe Reader, ανατρέξτε στο μενού **Βοήθεια και Υποστήριξη**.





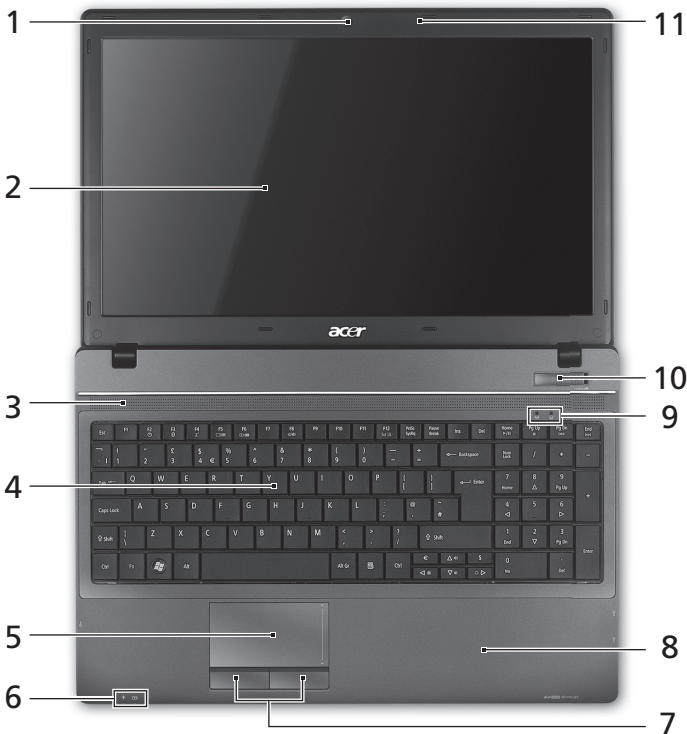

Μια ξενάγηση του φορητού υπολογιστή Acer

Μετά από την εγκατάσταση του υπολογιστή όπως απεικονίζεται στην αφίσα **Μόνο για αρχάριους...**, θα σας περιγράψουμε τα διάφορα μέρη του νέου σας φορητού υπολογιστή Acer.

Κάτοψη



#	Εικονίδιο	Στοιχείο	Περιγραφή
1		Κάμερα διαδικτύου Acer Crystal Eye	Κάμερα διαδικτύου για επικοινωνία βίντεο (ορισμένα μοντέλα μόνο).











#	Εικονίδιο	Στοιχείο	Περιγραφή
2		Οθόνη απεικόνισης	Αποκαλούμενη επίσης Οθόνη Υγρών Κρυστάλλων (Liquid-Crystal Display; LCD), απεικονίζει την έξοδο του υπολογιστή (Η σύνθεση ενδέχεται να ποικίλλει ανάλογα με το μοντέλο).
3		Ηχεία	Τα ηχεία μπροστά αριστερά και μπροστά δεξιά παρέχουν στερεοφωνικό ήχο.
4		Πληκτρολόγιο	Χρησιμοποιείται για την καταχώρηση δεδομένων στον υπολογιστή.
5		Ταμπλέτα αφής	Συσκευή κατάδειξης ευαίσθητη στην αφή που λειτουργεί ως ποντίκι υπολογιστή.
6		Ενδεικτης τροφοδοσίας ¹	Δηλώνει την κατάσταση τροφοδοσίας του υπολογιστή.
		Ενδεικτης μπαταρίας ¹	Δηλώνει την κατάσταση της μπαταρίας του υπολογιστή. 1. Φόρτιση: Η ενδεικτική λυχνία κατά τη φόρτιση της μπαταρίας μετατρέπεται σε πορτοκαλί. 2. Πλήρως φορτισμένη: Η ενδεικτική λυχνία μετατρέπεται σε μπλε όταν βρίσκεται σε λειτουργία εναλλασσόμενου ρεύματος (AC).
7		Κουμπιά κλικ (αριστερό και δεξιό)	Το κουμπιά, αριστερό και δεξιό, λειτουργούν σαν τα κουμπιά, αριστερό και δεξιό, του ποντικιού.
8		Στήριγμα παλάμης	Άνετος χώρος στήριξης των χεριών κατά τη χρήση του υπολογιστή.
9		HDD (σκληρός δίσκος)	Δηλώνει πότε είναι ενεργοποιημένη η μονάδα του σκληρού δίσκου.
		Ενδεικτική λυχνία επικοινωνίας	Υποδεικνύει την κατάσταση της συσκευής ασύρματης σύνδεσης του υπολογιστή.
10		Διακόπτης τροφοδοσίας	Ενεργοποιεί και απενεργοποιεί τον υπολογιστή.
11		Μικρόφωνο	Εσωτερικό μικρόφωνο για στερεοφωνικές ηχογραφήσεις.

1. Οι ενδεικτικές λυχνίες της πρόσοψης είναι ορατές ακόμη και όταν το καπάκι του υπολογιστή είναι κλειστό.

Πλήκτρα συντόμευσης

Ο υπολογιστής χρησιμοποιεί πλήκτρα συντόμευσης ή συνδυασμούς πλήκτρων για πρόσβαση στα περισσότερα από τα στοιχεία ελέγχου του υπολογιστή όπως η φωτεινότητα οθόνης και η ένταση ήχου.

Για να ενεργοποιήσετε τα πλήκτρα συντόμευσης, πιάστε παρατεταμένα το πλήκτρο **<Fn>** πριν πιάσετε το άλλο πλήκτρο του συνδυασμού πλήκτρων συντόμευσης.

Πλήκτρο συντόμευσης	Εικονίδιο	Λειτουργία	Περιγραφή
<Fn> + <F3>		Επικοινωνία	Ενεργοποιεί/απενεργοποιεί τις συσκευές επικοινωνίας του υπολογιστή. (Οι συσκευές επικοινωνίας ενδέχεται να διαφέρουν ανάλογα με τη σύνθεση.)
<Fn> + <F4>		Αναμονή	Θέτει τον υπολογιστή σε λειτουργία αναμονής.
<Fn> + <F5>		Εναλλαγή οθόνης	Μεταγωγή της εξόδου οθόνης μεταξύ οθόνης απεικόνισης, εξωτερικού μόνιτορ (εάν υπάρχει) ή και των δύο.
<Fn> + <F6>		Οθόνη απενεργοποιημένη	Απενεργοποιεί τον οπίσθιο φωτισμό της οθόνης απεικόνισης για εξοικονόμηση ενέργειας. Πιάστε οποιοδήποτε πλήκτρο για επιστροφή.
<Fn> + <F7>		Εναλλαγή Επιφάνειας Αφής	Ενεργοποιεί και απενεργοποιεί την επιφάνεια αφής.
<Fn> + <F8>		Εναλλαγή ηχείων	Ενεργοποιεί και απενεργοποιεί τα ηχεία.
<Fn> + <Δ>		Αύξηση έντασης	Αυξάνει την ένταση του ήχου.
<Fn> + <∇>		Μείωση έντασης	Μειώνει την ένταση του ήχου.
<Fn> + <◀>		Αύξηση φωτεινότητας	Αυξάνει τη φωτεινότητα της οθόνης.
<Fn> + <▶>		Μείωση φωτεινότητας	Μειώνει τη φωτεινότητα της οθόνης.

Πρόσοψη με το καπάκι κλειστό



#	Εικονίδιο	Στοιχείο	Περιγραφή
1		Ενδείκτης τροφοδοσίας ¹	Δηλώνει την κατάσταση τροφοδοσίας του υπολογιστή.
		Ενδείκτης μπαταρίας ¹	<p>Δηλώνει την κατάσταση της μπαταρίας του υπολογιστή.</p> <p>1. Φόρτιση: Η ενδεικτική λυχνία κατά τη φόρτιση της μπαταρίας μετατρέπεται σε πορτοκαλί.</p> <p>2. Πλήρως φορτισμένη: Η ενδεικτική λυχνία μετατρέπεται σε μπλε όταν βρίσκεται σε λειτουργία εναλλασσόμενου ρεύματος (AC).</p>
2		Αναγνώστης καρτών πολλών-σε-1	<p>Δέχεται Secure Digital (SD), MultiMediaCard (MMC), Memory Stick (MS), Memory Stick PRO (MS PRO), και xD-Picture Card (xD).</p> <p>Σημείωση: Πιέστε για αφαίρεση/ τοποθέτηση της κάρτας. Δυνατότητα λειτουργίας μόνο μιας κάρτας κάθε φορά.</p>







Πίσω πλευρά

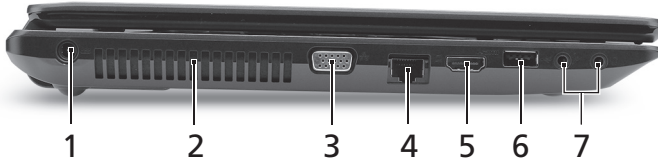

#	Εικονίδιο	Στοιχείο	Περιγραφή
1		Μπαταρία	Τροφοδοτεί με ρεύμα τον υπολογιστή, ώστε να τον χρησιμοποιείτε όταν δεν είναι συνδεδεμένος στο ρεύμα.



Αριστερή πλευρά



#	Εικονίδιο	Στοιχείο	Περιγραφή
1		Τζακ εισόδου συνεχούς ρεύματος (DC)	Συνδέεται σε προσαρμογέα εναλλασσόμενου ρεύματος (AC).
2		Θυρίδες εξαερισμού	Διατηρούν τον υπολογιστή σε χαμηλή θερμοκρασία, ακόμη και ύστερα από παρατεταμένη χρήση.
3		Θύρα εξωτερικής οθόνης απεικόνισης (VGA)	Συνδέεται σε συσκευή απεικόνισης (π.χ. εξωτερικό μόνιτορ, προβολέα LCD).
4		Θύρα Ethernet (RJ-45)	Συνδέεται σε δίκτυο Ethernet 10/100/1000.
5		Θύρα HDMI	Υποστηρίζει συνδέσεις ψηφιακού βίντεο υψηλής ευκρίνειας.
6		Θύρα USB 2.0	Συνδέεται σε συσκευές USB 2.0 (π.χ. ποντίκι USB, κάμερα USB).
7		Τζακ εισόδου μικροφώνου	Δέχεται εισόδους από εξωτερικά μικρόφωνα.
		Τζακ ακουστικών/ηχείου/γραμμής εξόδου	Συνδέεται σε συσκευές με γραμμή εξόδου ακουστικού σήματος (π.χ. ηχεία, ακουστικά).

Δεξιά πλευρά





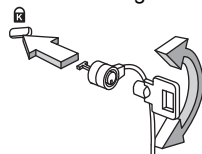

#	Εικονίδιο	Στοιχείο	Περιγραφή
1		Θύρα USB 2.0	Συνδέεται σε συσκευές USB 2.0 (π.χ. ποντίκι USB, κάμερα USB).
2		Μονάδα οπτικού δίσκου	Εσωτερική μονάδα οπτικού δίσκου, δέχεται CD ή DVD.
3		Φωτεινή ένδειξη πρόσβασης οπτικού δίσκου	Ανάβει κατά την ενεργοποίηση της μονάδας οπτικού δίσκου.
4		Κουμπί εκτίναξης της μονάδας οπτικού δίσκου	Χρησιμοποιείται για την εκτίναξη του συρταριού της μονάδας οπτικού δίσκου από τη μονάδα.
5		Οπή έκτακτης εκτίναξης	Χρησιμοποιείται για την εκτίναξη του συρταριού της μονάδας οπτικού δίσκου όταν ο υπολογιστής είναι απενεργοποιημένος. Σημείωση: Τοποθετήστε ένα μεταλλικό συνδετήρα μέσα στην οπή έκτακτης εκτίναξης για εκτίναξη του συρταριού της μονάδας οπτικού δίσκου όταν ο υπολογιστής είναι απενεργοποιημένος.
6		Υποδοχή λουκέτου τύπου Kensington	Συνδέεται σε λουκέτο ασφαλείας υπολογιστή συμβατό με Kensington. Σημείωση: Τυλίξτε το καλώδιο της κλειδαριάς ασφαλείας γύρω από ένα αμετακίνητο αντικείμενο όπως ένα τραπέζι ή το χερούλι ενός κλειδωμένου συρταριού. Εισάγετε την κλειδαριά στην εγκοπή και γυρίστε το κλειδί για να ασφαλίσετε την κλειδαριά. Διατίθενται επίσης μερικά μοντέλα χωρίς κλειδί.

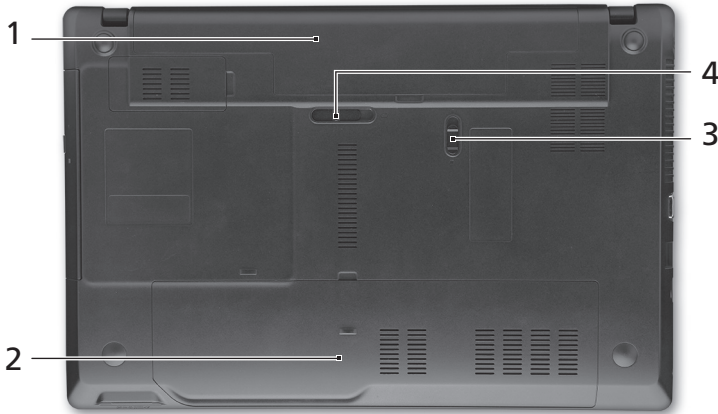

Άποψη βάσεως



#	Εικονίδιο	Στοιχείο	Περιγραφή
1		Φατνίο μπαταρίας	Περιέχει το πακέτο μπαταρίας του υπολογιστή.
2		Φατνίο σκληρού δίσκου	Περιέχει το σκληρό δίσκο του υπολογιστή (ασφαλίζεται με βίδες).
		Διαμέρισμα μνήμης	Περιέχει την κύρια μνήμη του υπολογιστή.
3		Λουκέτο μπαταρίας	Ασφαλίζει τη μπαταρία στη θέση της.
4		Μάνδαλο απασφάλισης μπαταρίας	Απασφαλίζει τη μπαταρία για αφαίρεση.

Περιβάλλον

- Θερμοκρασία:
 - Λειτουργίας: 5°C έως 35°C
 - Μη λειτουργίας: -20°C έως 65°C
- Υγρασία (μη συμπυκνούμενη):
 - Λειτουργίας: 20% έως 80%
 - Μη λειτουργίας: 20% έως 80%

TravelMate 5740/5740Z/5340 Serisi

Hızlı Başlama Kılavuzu

© 2010 Tüm Hakları Saklıdır.

TravelMate 5740/5740Z/5340 Serisi Hızlı Başlama Kılavuzu
Orijinal İhraç: 03/2010

TravelMate 5740/5740Z/5340 Serisi Dizüstü Bilgisayarı

Model numarası: _____

Seri numarası: _____

Satın alma tarihi: _____

Satın alma yeri: _____

İlk Yapılacaklar

Taşınabilir bilgisayar ihtiyacınızı karşılamak için Acer dizüstü bilgisayarı tercih ettiğiniz için teşekkür ederiz.

Kılavuzlarınız

Acer dizüstü bilgisayarı kullanırken size yardımcı olması için bir dizi rehber tasarladık:

İlk olarak **ayar poster**i bilgisayarınızı ayarlamanıza yardımcı olur.

TravelMate Serisi Orjijinal Kullanım Kılavuzu TravelMate ürün serisindeki tüm modellere uygulanan faydalı bilgiler içermektedir. Klavyeyi kullanma, Ses vs. gibi temel konular içermektedir. Lütfen aşağıda bahsedilen **AcerSystem Kullanım Kılavuzu**'nun doğası gereği zaman zaman serinin sadece belirli modellerinde bulunan işlev ve özelliklere başvurduğunu ancak satın aldığınız modelde gerekli olmayabileceğini unutmayın. Bu tarz örnekler (sadece belli modellerde) ibaresi ile belirtilmektedir.

Bu **Hızlı Başlama Kılavuzu** size bilgisayarınızın temel özelliklerini ve işlevlerini tanıtır. Bilgisayarınızın üretkenliğiniz üzerindeki etkisini arttırmak için lütfen **AcerSystem User Guide göz gezdirin**. Bu rehber; sistem işlevleri, veri kurtarma, genişletme seçenekleri ve sorun giderme gibi konular üzerine detaylı bilgi içerir. Buna ek olarak bilgisayarınızla ilgili garanti bilgileri, genel kuralları ve güvenlik uyarılarını içerir. Bu, bilgisayarınıza önceden yüklenmiş şekilde PDF dosya formatında gelmektedir. Ulaşmak için şu adımları izleyin:

- 1 **Başlat > Tüm Programlar > AcerSystem**'e tıklayın.
- 2 **AcerSystem Kullanım Kılavuzu**'na tıklayın.









Not: Adobe Reader gerektiren dosyayı inceleme. Bilgisayarınızda Adobe Reader yüklü değilse **AcerSystem Kullanım Kılavuzu**'na tıklayarak Adobe Reader kurulum programını çalıştırabilirsiniz. Yükleme tamamlandıktan sonra ekrandaki talimatları izleyin. Adobe Reader'ın nasıl kullanıldığını öğrenmek için, **Yardım ve Destek** menüsüne girin.

Acer dizüstü bilgisayarınızda bir gezinti

Başlangıç seviyesindekiler için... posterinde gösterildiği şekilde bilgisayarınızı kurduktan sonra, yeni Acer dizüstü bilgisayarınızı daha yakından tanıtalım.

Üstten görünüş



#	Simge	Öge	Tanım
1		Acer Crystal Eye video kamera	Video iletişimi için Web kamerası (sadece belli modellerde).
2		Görüntü ekranı	Sıvı Kristalli Görüntü (LCD) olarak da bilinir ve bilgisayar çıktılarını gösterir (yapılandırma modellere göre farklı olabilir).
3		Hoparlörler	Sol ve ön orta ve sağ öndeki hoparlörler stereo ses çıktısı sunar.
4		Klavye	Bilgisayarınıza veri girebilmek için.
5		Dokunmatik yüzey	Bilgisayar faresi gibi fonksiyonu olan, dokunmaya duyarlı işaret aygıtı.
6		Güç göstergesi ¹	Bilgisayarın güç durumunu gösterir.
		Batarya göstergesi ¹	Bilgisayarın pil durumunu gösterir. 1. Şarj: Pil şarj olurken ışık kehribar renginde yanar. 2. Tamamen şarj oldu: AC modundayken ışık mavi yanar.
7		Tıklama tuşları (sol ve sağ)	Sol ve sağ tuşlar, bilgisayar faresinin sağ ve sol tuşları ile aynı fonksiyondadır.
8		Palmrest	Bilgisayarı kullanırken ellerinizi destekleyen rahat bir alan.
9		HDD	Sabit diskin etkin olduğunu gösterir.
		İletişim göstergesi	Bilgisayarın kablosuz bağlanabilirlik aygıt durumunu gösterir.
10		Güç anahtarı	Bilgisayarı açar ve kapatır.
11		Mikrofon	Ses kaydı için dahili mikrofon.

1. Ön panel göstergeleri bilgisayar kapağı kapalı olsa bile görülebilir.

Kısayol Tuşları

Bilgisayarda, ekran parlaklığı ve ses çıkışı gibi bilgisayarın birçok kontrolüne erişimin sağlanması için faydalı tuşlar yer almaktadır.

Faydalı tuşları etkinleştirmek için, faydalı tuş kombinasyonundaki diğer tuşa basmadan önce **<Fn>** tuşuna basılı tutun.

Faydalı tuş	Simge	İşlev	Tanım
<Fn> + <F3>		İletişim	Bilgisayarın iletişim aygıtlarını etkinleştirir/engeller. (İletişim aygıtları yapılandırmaya göre farklılık gösterebilir.)
<Fn> + <F4>		Uyku	Bilgisayarı Uyku moduna sokar.
<Fn> + <F5>		Ekran değişikliği	Görüntü ekranı, harici monitör (eğer bağlıysa) ve ikisi arasında ekran çıktısını değiştirir.
<Fn> + <F6>		Ekran kapalı	Görüntü ekran arka ışığını, güçten kazanmak için kapatır. Geriye dönmek için herhangi bir tuşa basın.
<Fn> + <F7>		Dokunmatik yüzey değişikliği	Dokunmatik yüzeyi açar ve kapatır.
<Fn> + <F8>		Hoparlör değişikliği	Hoparlörleri açar ve kapatır.
<Fn> + <Δ>		Ses aç	Sesi artırır.
<Fn> + <▽>		Ses kapat	Sesi azaltır.
<Fn> + <▷>		Parlaklığı artır	Ekran parlaklığını artırır.
<Fn> + <◁>		Parlaklığı azalt	Ekran parlaklığını azaltır.

Kapalı ön görünüm



#	Simge	Öge	Tanım
1		Güç göstergesi ¹	Bilgisayarın güç durumunu gösterir.
		Batarya göstergesi ¹	Bilgisayarın pil durumunu gösterir. 1. Şarj: Pil şarj olurken ışık kehribar renginde yanar. 2. Tamamen şarj oldu: AC modundayken ışık mavi yanar.
2		Çoklu kart okuyucu	Güvenli Dijital (SD), Çoklu Ortam Kartı(MMC), Bellek Çubuğu (MS), Bellek Çubuğu PRO (MS PRO), xD-Görüntü Kartı (xD)'ni kabul eder. Not: Kartı çıkartmak/takmak için itin. Her hangi bir zamanda sadece bir kart çalışabilir.



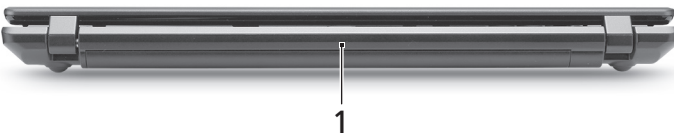



Arka görünüm

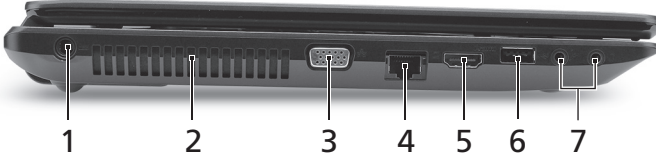

#	Simge	Öge	Tanım
1		Pil	Bilgisayar fişte takılı değilken bilgisayara güç vermeyi sağlar.



Sol görünüm



#	Simge	Öge	Tanım
1		DC-in jakı	AC adaptöre bağlanır.
2		Havalandırma yuvaları	Bilgisayarınızın uzun kullanımlar sonrası bile ısınmamasını sağlarlar.
3		Harici görüntü (VGA) portu	Bir görüntü aygıtına bağlar (örneğin, harici monitör, LCD projektör).
4		Ethernet (RJ-45) portu	Ethernet 10/100/1000-temelli ağa bağlar.
5		HDMI portu	Yüksek çözünürlüklü dijital video bağlantılarını destekler.
6		USB 2.0 portu	USB 2.0 cihazlarına bağlantıyı sağlar (örneğin USB fare, USB kamera).
7		Mikrofon-in jakı	Harici mikrofon girişlerini kabul eder.
		Kulaklık/hoparlör/hat çıkışı jakı	Sesli line-out cihazlarına bağlantıyı sağlar (örneğin hoparlör, kulaklık).

Sağ görünüm





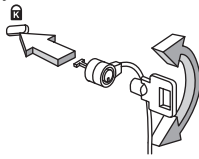

#	Simge	Öge	Tanım
1		USB 2.0 portu	USB 2.0 cihazlarına bağlantıyı sağlar (örneğin USB fare, USB kamera).
2		Optik sürücü	Dahili optik sürücü; CD'leri veya DVD'leri kabul eder.
3		Optik sürücü erişim göstergesi	Optik sürücü etkinken yanar.
4		Optik sürücü çıkarma tuşu	Optik diski sürücüden çıkarır.
5		Acil durum çıkarma yuvası	Bilgisayara kapandığında optik sürücü yatağını çıkarır. Not: Bilgisayar kapatıldığında optik sürücü tepsisini çıkarmak için acil durum çıkarma yuvasına bir kağıt atacısın.
6		Kensington kilit yuvası	Kensington-uyumlu bilgisayar güvenlik kilidine bağlar. Not: Bilgisayar güvenlik kilidi kablosunu, masa ya da kilitli bir dolabın tutacağı gibi hareket etmeyen bir nesnenin etrafına dolayın. Kilidi çentiğe sokun ve kilidi kapamak için anahtarı çevirin. Anahtarsız modeller de mevcuttur.

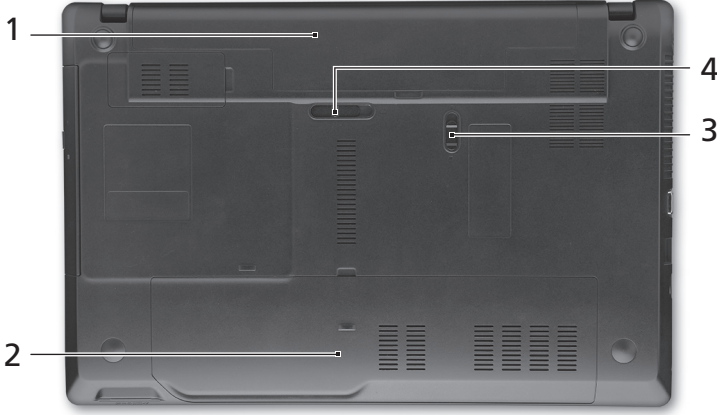

Alt görünüm



#	Simge	Öge	Tanım
1		Pil bölmesi	Bilgisayar pil takımının yeridir.
2		Sabit disk bölmesi	Bilgisayarın sabit diskini barındırır (vidalarla sabitlenmiştir).
		Bellek bölmesi	Bilgisayarın ana hafızasını barındırır.
3		Pil kilidi	Pil yerine oturduğunda kilitler.
4		Pil çıkarma mandalı	Eskiyen pilleri çıkarmanız içindir.

Ortam

- Sıcaklık:
 - Çalışma: 5°C ila 35°C arasında
 - Çalışmadığı durumda: -20°C ila 65°C arasında
- Nem (yoğunlaşmayan):
 - Çalışma: %20 ila %80 arasında
 - Çalışmadığı durumda: %20 ila %80 arasında

TravelMate 5740/5740Z/ 5340 シリーズ

クイックガイド

© 2010 All Rights Reserved.

TravelMate 5740/5740Z/5340 シリーズクイックガイド
初版：2010年3月

TravelMate 5740/5740Z/5340 シリーズノートブックコンピューター

モデル番号： _____

シリアル番号： _____

購入日： _____

購入場所： _____

はじめに

Acer ノートブックをお買い上げいただきありがとうございます。

各種ガイドについて

本製品を快適にご使用いただくために、次のガイドが提供されています。

初めての方は、**セットアップポスター**の解説に従ってコンピュータを設定してください。

TravelMate シリーズ汎用ガイドには、TravelMate シリーズの全モデルに共通の情報が記載されています。本書にはキーボード、およびオーディオの使い方など、基本的な情報が含まれています。以下に紹介する **AcerSystem User Guide (ユーザーズマニュアル)** に記載される説明の中には、特定モデルにのみ適用されるものがあり、お客様が購入されたモデルには該当しない場合があります。このような場合には、「特定モデルのみ」という注意書きが記載されています。

この**クイックガイド**では、本 PC を効率よく使用するための方法を説明します。

AcerSystem User Guide (ユーザーズマニュアル) は、本 PC についてわかりやすく説明しておりますので、**良くお読み頂き、指示に従ってください**。このガイドには、システムユーティリティ、データ復元、拡張オプション、トラブルシューティングなどの詳細情報を記載しております。その他、保証情報および一般的な規制、安全のためのご注意なども記載されています。これは PDF (Portable Document Format) フォーマットでもお読みいただけるよう、ノートブックにあらかじめダウンロードされています。このガイドをご覧になるには、以下の手順に従ってください。

- 1 **スタート > すべてのプログラム > AcerSystem** を選択します。
- 2 **AcerSystem User Guide (ユーザーズマニュアル)** をクリックしてください。



.....





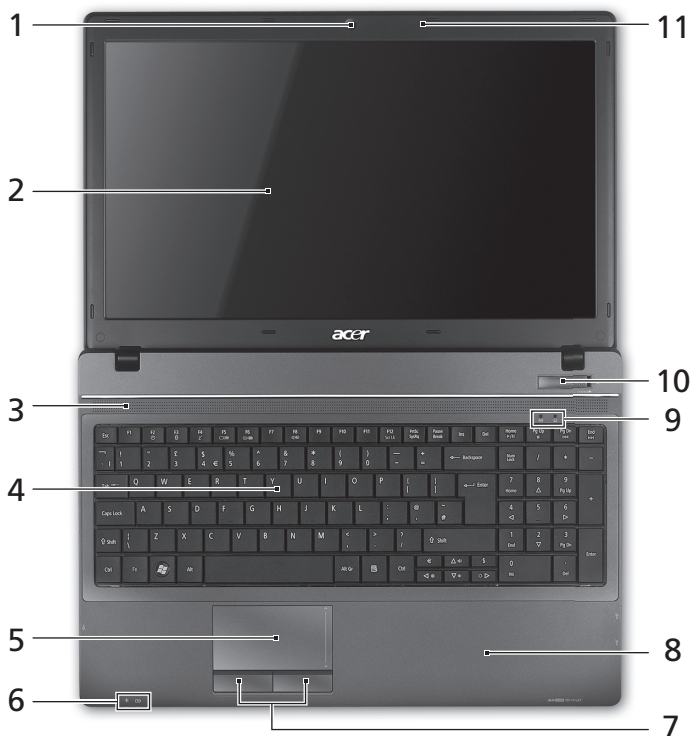

注意：ファイルを表示するには、Adobe Reader が必要となります。Adobe Reader がセットアップされていない場合、**AcerSystem User Guide (ユーザーズマニュアル)** をクリックすると Adobe Reader セットアッププログラムを実行します。画面の指示にしたがってインストールを完了してください。Adobe Reader の使い方については、**ヘルプとサポート**メニューにアクセスしてください。

Acer ノートブックツアー

上面



#	アイコン	アイテム	説明
1		Acer Crystal Eye ウェブカメラ	ビデオコミュニケーション用の Web カメラです (特定モデルのみ)。
2		ディスプレイ スクリーン	液晶ディスプレイ (LCD) とも呼びます。コンピュータ出力を表示します (構成はモデルによって異なります)。











#	アイコン	アイテム	説明
3		スピーカー	正面左、および正面右の各スピーカーによりステレオオーディオを出力します。
4		キーボード	コンピューターにデータを入力します。
5		タッチパッド	コンピューターマウスと同じように機能し、指を触れることで反応するポインティングデバイスです。
6		電源インジケータ ¹	PCの電源がオンのときに点灯します。
		バッテリーインジケータ ¹	バッテリーパックが充電されているときに点灯します。 1. 充電中 ：バッテリーを充電している間、ランプは琥珀色に点灯します。 2. 完全に充電 ：ACモードでは、ライトが青くなります。
7		クリックボタン (左右)	左右のボタンはマウスの左右のボタンと同じように機能します。
8		パームレスト	コンピューター操作時に手を置く場所です。
9		HDD	ハードディスクドライブがアクティブになると点灯します。
		通信インジケータ	PCワイヤレス接続装置がオンのときに点灯します。
10		電源スイッチ	コンピューターの電源をオン/オフにします。
11		マイクロフォン	録音用の内部マイクロフォンです。

1. フロントパネルのインジケータは、コンピューターカバーが閉じた状態でも見えるようになっています。

ホットキー



このコンピューターでは、ホットキーや2つ以上のキーを組み合わせることで、画面の輝度や出力音量など、コンピューターのほとんどのコントロールを調整することができます。

ホットキーを利用するときは、<Fn> キーを押しながら、ホットキーの組み合わせとなる、もう1つのキーを押してください。

ホットキー	アイコン	機能	説明
<Fn> + <F3>		コミュニケーション	コンピューターの通信機器を有効/無効にします。(通信機器は、構成内容によって異なります。)
<Fn> + <F4>		スリープ	PC をスリープモードに切り替えます。
<Fn> + <F5>		ディスプレイ切り替え	ディスプレイ出力を、ディスプレイスクリーン、外付けモニター(接続されている場合)、またはその両方に切り替えます。
<Fn> + <F6>		ディスプレイオフ	ディスプレイのバックライトをオフにして、電源を節約します。キーをどれか押すと、バックライトはオンになります。
<Fn> + <F7>		タッチパッド ON / OFF	タッチパッドをオン/オフにします。
<Fn> + <F8>		スピーカー ON / OFF	スピーカーをオン/オフにします。
<Fn> + <△>		ボリュームアップ	スピーカーのボリュームを上げます。
<Fn> + <▽>		ボリュームダウン	スピーカーのボリュームを下げます。
<Fn> + <▷>		輝度を上げる	画面輝度が上がります。
<Fn> + <◁>		輝度を下げる	画面輝度が下がります。

正面（閉じた場合）



#	アイコン	アイテム	説明
1		電源インジケータ ¹	PCの電源がオンのときに点灯します。
		バッテリーインジケータ ¹	<p>バッテリーパックが充電されているときに点灯します。</p> <p>1. 充電中：バッテリーを充電している間、ランプは琥珀色に点灯します。</p> <p>2. 完全に充電：ACモードでは、ライトが青くなります。</p>
2		1 台多機能のカードリーダー	<p>Secure Digital (SD)、MultiMediaCard (MMC)、Memory Stick (MS)、Memory Stick PRO (MS PRO)、xD-Picture Card (xD) に対応しています。</p> <p>注意：押すと、カードの取り出し/挿入ができます。一度に1枚のカードしか操作できません。</p>







背面

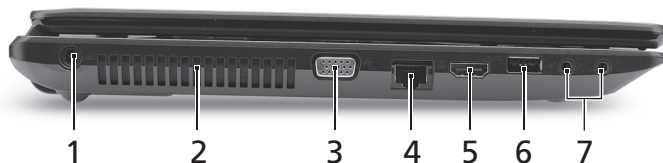

#	アイコン	アイテム	説明
1		バッテリー	電源コードをコンセントから外した場合に、コンピューターに電源を供給します。

左面



#	アイコン	アイテム	説明
1		DC 入力ジャック	AC アダプタに接続します。
2		通気孔	長時間使用してもコンピューターが過熱しないよう冷却します。
3		外部ディスプレイ (VGA) ポート	ディスプレイデバイスに接続します (外付けモニター、LCD プロジェクタなど)。
4		Ethernet (RJ-45) ポート	Ethernet 10/100/1000 ベースのネットワークに接続します。
5		HDMI ポート	高性能デジタルビデオ接続に対応します。
6		USB 2.0 ポート	USB 2.0 デバイスに接続します (USB マウス、USB カメラなど)。
7		マイクロフォン 入力ジャック	外部マイクロフォンを接続します。
		ヘッドフォン/ スピーカー/ 出力ジャック	オーディオ出力デバイスを接続します (スピーカー、ヘッドフォンなど)。

右面





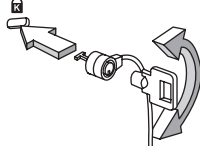

#	アイコン	アイテム	説明
1		USB 2.0 ポート	USB 2.0 デバイスを接続します (USB マウス、USB カメラなど)。
2		光学ドライブ	内部光学ドライブ (CD および DVD に対応)。
3		光学ディスクアクセスインジケータ	光学ドライブが使用中のときには点灯します。
4		光学ドライブイジェクトボタン	ドライブから光学ディスクを取り出します。
5		緊急用イジェクトホール	コンピューターがオフになっているときに、光学ドライブトレイを引き出します。 注意： コンピューターがオフの状態の場合は、緊急用イジェクトホールにペーパークリップを差し込むと光学ドライブトレイが出てきます。
6		Kensington ロックスロット	Kensington 対応コンピューターセキュリティロックに接続します。 注意： コンピューター用安全ロックのケーブルを机やロックした引き出しの取っ手などの動かないものにつなぎます。ロックをセキュリティキーロックノッチに挿入し、キーをまわしてロックを固定してください。キーを使用しないモデルもあります。

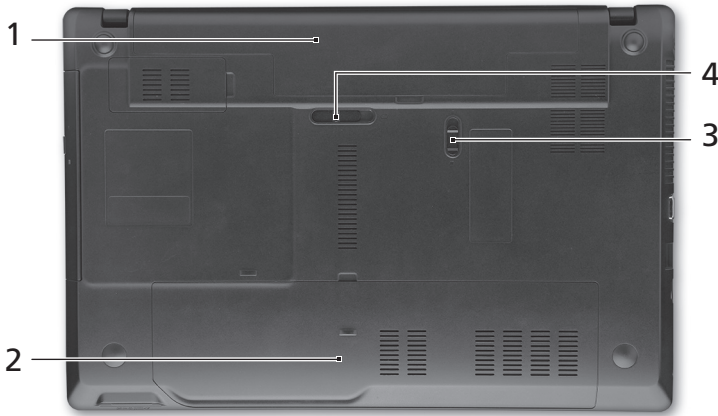

底面



#	アイコン	アイテム	説明
1		バッテリーベイ	コンピューターのバッテリーパックを装着します。
2		ハードディスクベイ	コンピューターのハードディスクを装着します(ネジで固定)。
		メモリコンパートメント	コンピューターのメインメモリを装着します。
3		バッテリーロック	バッテリーを定位置にロックします。
4		バッテリー取り外しつまみ	バッテリーを取り出します。

環境

- 温度：
 - 操作時：5°C ~ 35°C
 - 非操作時：-20°C ~ 65°C
- 湿度(結露しないこと)：
 - 操作時：20% ~ 80%
 - 非操作時：20% ~ 80%

TravelMate 5740/5740Z/5340 시리즈

빠른 시작 설명서

© 2010 All Rights Reserved.

TravelMate 5740/5740Z/5340 시리즈 빠른 시작 설명서
최초 발행일 : 03/2010

TravelMate 5740/5740Z/5340 시리즈 노트북 PC

모델 번호 : _____

일련 번호 : _____

구입 날짜 : _____

구입 장소 : _____

사용 전 유의 사항

Acer 노트북을 선택해주셔서 감사합니다. 이 노트북이 귀하의 모바일 컴퓨팅 요구를 충족시켜 드릴 것입니다.

제공되는 설명서

Acer 노트북을 사용하는 데 도움을 줄 수 있는 여러 설명서가 제공됩니다.

설치 포스터는 컴퓨터 설정을 시작하는 데 유용합니다.

TravelMate 시리즈 일반 사용 설명서에는 TravelMate 제품 시리즈의 모든 모델에 적용되는 유용한 정보가 포함되어 있습니다. 이 설명서에서는 키보드 사용, 오디오 등과 같은 기본적인 주제를 다룹니다. 설명서의 특성상, 아래 언급된 **AcerSystem 사용 설명서**에는 이 시리즈의 특정 모델에만 있고 귀하가 구입한 모델에는 없는 기능 또는 특징에 대한 설명이 포함되어 있을 수 있음을 양지하십시오. 그러한 부분에는 " 특정 모델에만 해당 " 과 같은 텍스트가 표시되어 있습니다.

이 **빠른 시작 설명서**에서는 새 컴퓨터의 기본 특징 및 기능을 소개합니다. 컴퓨터를 좀더 생산적으로 활용하는 방법에 대한 자세한 내용은 **AcerSystem 사용 설명서**를 참조하십시오. 이 설명서에서는 시스템 유틸리티, 데이터 복구, 확장 옵션 및 문제 해결과 같은 주제를 자세하게 설명합니다. 또한 노트북에 대한 일반 규정과 안전 주의 사항 및 보증 정보가 포함되어 있습니다. 이 설명서는 PDF (Portable Document Format) 파일로 제공되며 노트북에 이미 설치되어 있습니다. 다음 단계에 따라 설명서에 액세스할 수 있습니다.

- 1 시작 > 모든 프로그램 > **AcerSystem** 을 클릭합니다.
- 2 **AcerSystem 사용 설명서**를 클릭합니다.









참고: 이 파일을 보려면 Adobe Reader 가 필요합니다. 컴퓨터에 Adobe Reader 가 설치되어 있지 않은 경우 **AcerSystem 사용 설명서**를 클릭하면 자동으로 Adobe Reader 설치 프로그램이 실행됩니다. 화면의 지시에 따라 나머지 설치 과정을 완료합니다. Adobe Reader 사용 방법에 대한 지침을 보려면 **Help and Support** (도움말 및 지원) 메뉴에 액세스하십시오.

Acer 노트북 둘러보기

사용을 위한 준비 포스터에 설명된 대로 컴퓨터를 설치했다면 이제 새 Acer 노트북을 살펴볼 차례입니다.

위에서 본 모습



#	아이콘	항목	설명
1		Acer Crystal Eye 웹캠	비디오 통신용 웹 카메라입니다 (특정 모델에만 해당).
2		디스플레이 화면	LCD (액정 디스플레이) 라고도 하며, 컴퓨터 출력을 표시합니다 (구성은 모델에 따라 다릅니다).
3		스피커	왼쪽 앞과 오른쪽 앞 스피커로 스테레오 오디오를 출력합니다.
4		키보드	컴퓨터에 데이터를 입력하는 데 사용됩니다.
5		터치패드	컴퓨터 마우스와 같은 역할을 하는 접촉식 포인팅 장치입니다.
6		전원 표시등 ¹	컴퓨터의 전원 상태를 표시합니다.
		배터리 표시등 ¹	컴퓨터의 배터리 상태를 표시합니다. 1. 충전 중 : 배터리가 충전 중이면 황색 불이 켜집니다. 2. 충전 완료 : AC 모드일 때 파란 불이 켜집니다.
7		누름 단추들 (왼쪽 및 오른쪽)	왼쪽과 오른쪽의 단추는 마우스의 왼쪽 및 오른쪽 단추와 같은 역할을 합니다.
8		손목 받침대	컴퓨터를 사용할 때 편안하게 손을 올려 놓는 영역입니다.
9		HDD	하드 디스크 드라이브가 동작 중이면 불이 켜집니다.
		통신 표시등	컴퓨터의 무선 연결 장치 상태를 표시합니다.
10		전원 스위치	컴퓨터를 켜고 끕니다.
11		마이크	소리를 녹음할 수 있는 내부 마이크입니다.

1. 전면 패널 표시등은 컴퓨터 덮개를 닫은 상태에서도 볼 수 있습니다.

바로 가기 키

컴퓨터에서는 화면 밝기와 볼륨 출력 같은 대부분의 컴퓨터 컨트롤에 액세스하기 위해 바로 가기 키 또는 키 조합이 사용됩니다.

바로 가기 키를 활성화하려면 바로 가기 키 조합의 다른 키를 누르기 전에 <Fn> 키를 누릅니다.

바로 가기 키	아이콘	기능	설명
<Fn> + <F3>		통신	컴퓨터의 통신 장치를 활성화 / 비활성화합니다. (통신 장치는 구성에 따라 다를 수 있습니다.)
<Fn> + <F4>		절전	컴퓨터를 절전 모드로 설정합니다.
<Fn> + <F5>		디스플레이 전환	디스플레이 출력을 디스플레이 화면, 외부 모니터 (연결된 경우) 또는 둘다에 보내도록 선택합니다.
<Fn> + <F6>		디스플레이 끄기	전원을 절약하기 위해 디스플레이 화면의 백라이트를 끕니다. 화면을 다시 켜려면 임의의 키를 누릅니다.
<Fn> + <F7>		터치패드 전환	터치패드를 켜고 끕니다.
<Fn> + <F8>		스피커 전환	스피커를 켜고 끕니다.
<Fn> + <△>		볼륨 크게	소리를 높입니다.
<Fn> + <▽>		볼륨 작게	소리를 낮춥니다.
<Fn> + <▷>		밝게	화면 밝기를 증가시킵니다.
<Fn> + <◁>		어둡게	화면 밝기를 감소시킵니다.

닫힌 상태의 앞 모습



#	아이콘	항목	설명
1		전원 표시등 ¹	컴퓨터의 전원 상태를 표시합니다.
		배터리 표시등 ¹	컴퓨터의 배터리 상태를 표시합니다. 1. 충전 중 : 배터리가 충전 중이면 황색 불이 켜집니다. 2. 충전 완료 : AC 모드일 때 파란 불이 켜집니다.
2		멀티 카드 판독기	Secure Digital (SD), MultiMediaCard (MMC), Memory Stick (MS), Memory Stick PRO (MS PRO) 및 xD-Picture Card (xD) 를 사용할 수 있습니다. 참고 : 카드를 눌러 제거 또는 설치합니다. 카드를 한 번에 하나만 사용할 수 있습니다.

뒤쪽 모습



#	아이콘	항목	설명
1		배터리	플러그를 뺀 상태에서 컴퓨터가 사용할 수 있는 전원을 제공합니다.

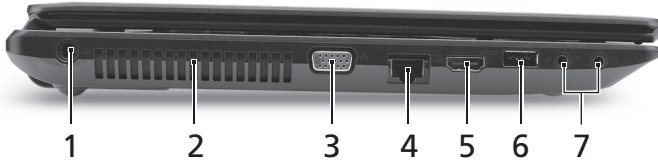

왼쪽 모습



#	아이콘	항목	설명
1		DC 입력 잭	AC 어댑터에 연결합니다.
2		통풍용 슬롯	장시간 사용한 후에도 컴퓨터를 차갑게 유지할 수 있습니다.
3		외부 디스플레이 (VGA) 포트	디스플레이 장치 (예 : 외부 모니터 , LCD 프로젝터) 를 연결합니다 .
4		이더넷 (RJ-45) 포트	10/100/1000 이더넷 네트워크에 연결합니다 .
5		HDMI 포트	고선명 디지털 비디오 연결을 지원합니다 .
6		USB 2.0 포트	USB 2.0 장치 (예 : USB 마우스 , USB 카메라) 에 연결합니다 .
7		마이크 입력 잭	외부 마이크로 소리를 입력할 때 사용합니다 .
		헤드폰 / 스피커 / 출력 잭	오디오 출력 장치에 연결합니다 (예 : 스피커 , 헤드폰) .

오른쪽 모습





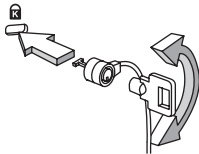

#	아이콘	항목	설명
1		USB 2.0 포트	USB 2.0 장치 (예 : USB 마우스 , USB 카메라) 에 연결합니다 .
2		광드라이브	내부 광드라이브 . CD 또는 DVD 를 넣습 니다 .
3		광디스크 액세스 표시등	광드라이브가 작동 중이면 불이 켜집니다 .
4		광드라이브 꺼내기 단추	드라이브에서 광디스크를 꺼냅니다 .
5		비상용 꺼내기 구멍	컴퓨터가 꺼졌을 때 광드라이브 트레이를 꺼낼 수 있습니다 . 참고 : 컴퓨터가 꺼졌을 때 클립을 비상용 꺼 내기 구멍에 삽입하여 광드라이브 트레이를 꺼내십시오 .
6		Kensington 잠금 장치 슬롯	Kensington 호환 컴퓨터 보호용 잠금 장치 를 연결합니다 . 참고 : 테이블이나 장긴 서랍의 손잡이 같은 고정된 물체에 컴퓨터 보호용 케이블을 맵니 다 . 노치에 자물쇠를 걸고 열쇠를 돌려 잠급 니다 . 열쇠가 없는 모델을 사용할 수도 있습 니다 .

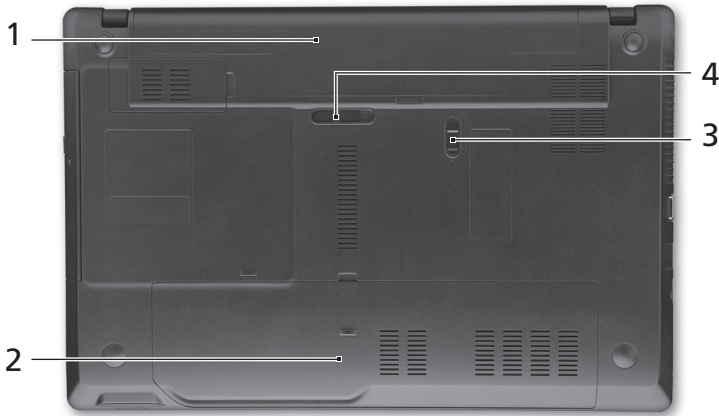

바닥 모습



#	아이콘	항목	설명
1		배터리 장착부	컴퓨터의 배터리 팩을 넣습니다.
2		하드 디스크 장착부	컴퓨터의 하드 디스크를 넣습니다 (나사로 고정).
		메모리 장착부	컴퓨터의 주 메모리를 넣습니다.
3		배터리 잠금	장착된 배터리를 빠지지 않도록 잠급니다.
4		배터리 제거용 래치	제거를 위해 배터리를 뺄 때 사용합니다.

환경

- 온도 :
 - 작동 : 5°C - 35°C
 - 비작동 : -20°C - 65°C
- 습도 (비응축):
 - 작동 : 20% - 80%
 - 비작동 : 20% - 80%

TravelMate 5740/5740Z/5340 系列

快速使用指南

© 2010 版權所有

TravelMate 5740/5740Z/5340 系列快速使用指南
初版：2010 年 3 月

TravelMate 5740/5740Z/5340 系列筆記型電腦

產品型號： _____

產品序號： _____

購買日期： _____

購買地點： _____

初步設定

首先，感謝您選擇 Acer 筆記型電腦，其會是滿足您行動運算需求的最佳首選。

使用指南

為協助您順利使用 Acer 筆記型電腦，我們特地設計了以下的使用指南：

首先，**設定海報**可協助您開始設定您的電腦。

印刷版的 **TravelMate 系列一般使用指南**內含一些實用的資訊，適用於 TravelMate 產品系列的所有型號。其中包括基本主題，例如使用鍵盤、音訊等。請注意，由於其性質不同，下列所提及之 **AcerSystem 使用指南**將會不定時請您參照只有特定型號所包含的功能或特點，而您所購買的機型不一定會包含這些功能。此類情形將以「僅適用於特定機型」等文字標示。

本**快速指南**介紹本電腦的基本特性和功能。有關本電腦如何幫助您提高效率的更多資訊，請參閱「**AcerSystem User Guide**」。本使用手冊包含系統公用程式、資料復原、擴充配備和疑難排解等詳細資訊。此外，本指南也包含筆記型電腦的保固資訊，一般規範及安全注意事項。該文件以「可攜式文件格式」(PDF) 提供，並已預載在您的筆記型電腦上。若要開啓此 PDF 檔案，請依下列步驟操作：

- 1 按一下「開始」>「所有程式」>「AcerSystem」。
- 2 按一下「AcerSystem User Guide」。









注意：若要閱讀 PDF 檔案，必須先安裝 Adobe Reader 程式。若系統未安裝 Adobe Reader 程式，請先按一下「AcerSystem User Guide」並執行 Adobe Reader 安裝程式。請遵循畫面上的指示完成安裝程序。如需 Adobe Reader 使用說明，請點選「**說明和支援**」功能表以獲得更詳細資訊。

Acer 筆記型電腦導覽

依據「入門者專用...」海報的圖解設置好電腦後，現在讓我們來看看您的 Acer 筆記型電腦擁有哪些功能。

上視圖





#	圖示	項目	說明
1		Acer Crystal Eye 網路攝影機	用於視訊通訊的網路相機 (僅適用於特定機型)。
2		顯示螢幕	亦稱為液晶顯示器 (Liquid-Crystal Display ; LCD)，用於顯示電腦資料的輸出 (設定將依機型而有所不同)。
3		喇叭	前方左邊和前方右邊的喇叭提供了立體音效的輸出。
4		鍵盤	可用來將資料輸入電腦。
5		觸控板	觸控感應式移動游標裝置，功能等同於電腦的滑鼠。
6		電源指示燈 ¹	表示電腦的電源狀態。
		電池指示燈 ¹	表示電腦的電池狀態。 1. 充電中： 當電池在充電時，指示燈會亮琥珀色。 2. 充電完畢： 當使用 AC 電源模式時，指示燈會亮藍色。
7		按鍵 (左 / 右)	左鍵和右鍵的功能等同於滑鼠的左鍵和右鍵。
8		腕靠	讓您在使用電腦時，可舒適擺放手腕的位置。
9		HDD	當存取硬碟時，指示燈會亮起。
		通訊指示燈	表示電腦無線連線能力的狀態。
10		電源開關	開啓和關閉電腦。
11		麥克風	內建的麥克風，用於錄音。

1. 即使在電腦螢幕關上時，您依然可看見位於前面板的狀態指示燈。

快速鍵

利用此電腦的快捷鍵或組合鍵可存取大部分的控制指令，例如：螢幕亮度和音量輸出。

若要使用快速鍵，請先按住 **<Fn>** 鍵，再按下組合鍵的另一按鍵。

快速鍵	圖示	功能	說明
<Fn> + <F3>		通訊	啓用 / 停用電腦的通訊裝置。 (通訊裝置可能根據組態而有所不同。)
<Fn> + <F4>		睡眠	讓電腦進入睡眠模式。
<Fn> + <F5>		螢幕顯示切換	在螢幕及外接顯示器 (如有連接) 之間 切換，或同時顯示。
<Fn> + <F6>		關閉顯示螢幕	關閉顯示螢幕背光，以節省電力。 按下任意鍵即可返回。
<Fn> + <F7>		觸控板切換鈕	開啓及關閉觸控板。
<Fn> + <F8>		喇叭切換鈕	開啓和關閉喇叭。
<Fn> + <△>		提高音量	提高喇叭音量。
<Fn> + <▽>		降低音量	降低喇叭音量。
<Fn> + <▷>		調高亮度	調高螢幕亮度。
<Fn> + <◁>		調低亮度	調低螢幕亮度。

上蓋闔起的前視圖



#	圖示	項目	說明
1		電源指示燈 ¹	表示電腦的電源狀態。
		電池指示燈 ¹	表示電腦的電池狀態。 1. 充電中： 當電池在充電時，指示燈會亮琥珀色。 2. 充電完畢： 當使用 AC 電源模式時，指示燈會亮藍色。
2		多合一讀卡機	可支援 Secure Digital (SD)、MultiMediaCard (MMC)、Memory Stick (MS)、Memory Stick PRO (MS PRO)、xD-Picture Card (xD)。 注意： 輕壓即可移除/安裝卡片。無論何時皆只能使用一張卡片。







後視圖

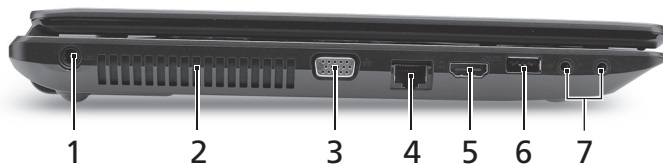

#	圖示	項目	說明
1		電池組	在電腦未連接電源時提供操作所需要的電力。



左視圖



#	圖示	項目	說明
1		DC 輸入插孔	連接到 AC 變壓器。
2		通風槽	可讓電腦在長時間使用後仍然能夠保持冷卻狀態。
3		外接顯示螢幕 (VGA) 連接埠	連接到顯示器裝置 (例如：外接式顯示器、LCD 投影機)。
4		乙太網路 (RJ-45) 連接埠	連接到以 10/100/1000 為基礎的乙太網路。
5		HDMI 埠	支援高清晰度數位視訊連線。
6		USB 2.0 埠	連接至 USB 2.0 裝置 (例如：USB 滑鼠、USB 攝影機)。
7		麥克風輸入插孔	接受從外接麥克風所輸入的聲音。
		耳機 / 喇叭 / 線路輸出插孔	連接到外接音訊裝置 (例如：喇叭、耳機)。

右視圖





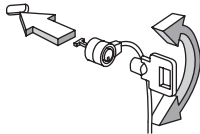

#	圖示	項目	說明
1		USB 2.0 埠	連接到 USB 2.0 裝置 (例如：USB 滑鼠、USB 網路攝影機)。
2		光碟機	內部光碟機，可放入 CD 或 DVD。
3		光碟存取指示燈	當正在存取光碟時，指示燈會亮起。
4		光碟退出鍵	可將光碟從光碟機中退出。
5		緊急退出孔	可在電腦關機狀態下退出光碟機托盤。 注意： 在電腦關機時將迴紋針插入緊急退出孔，即可退出光碟機托盤。
6		Kensington 安全鎖插槽	連接到與 Kensington 相容的電腦安全鎖。 注意： 將電腦安全鎖電纜線繞著無法移動的物品打個圈；例如：桌子或鎖住的抽屜把手。再將鎖插入鎖孔中，並轉動鑰匙以便上鎖。此外，還有些無鑰匙安全鎖的型號可供使用者選擇。

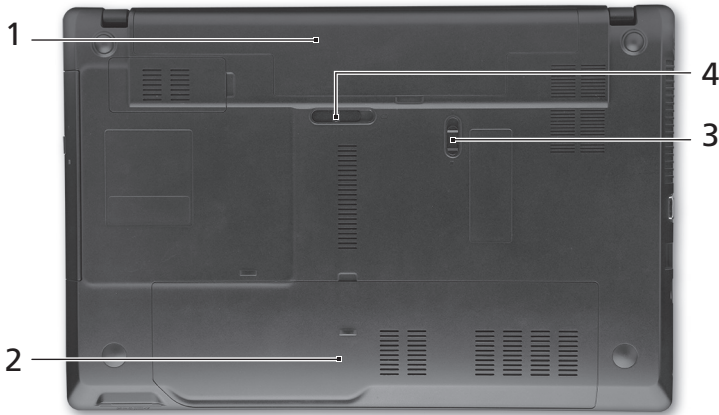

底視圖



#	圖示	項目	說明
1		電池槽	用於安裝電腦的電池組。
2		硬碟槽	用於安裝電腦的硬碟 (以螺絲固定)。
		記憶體槽	用於安裝電腦的主記憶體。
3		電池組固定鎖	可將電池鎖到定位。
4		電池卸除卡榫	用於卸下電池組。

環境

- 溫度：
 - 操作中：5°C 到 35°C
 - 非操作中：-20°C 到 65°C
- 溼度 (非冷凝狀態)：
 - 操作中：20% 到 80%
 - 非操作中：20% 到 80%

TravelMate 5740/5740Z/5340 系列

快速指南

© 2010 保留所有权利

TravelMate 5740/5740Z/5340 系列快速指南
初版发行日期：2010 年 3 月

TravelMate 5740/5740Z/5340 系列笔记本电脑

产品型号： _____

产品序号： _____

购买日期： _____

购买地点： _____

使用入门

感谢您选购 Acer 笔记本电脑，让它满足您随时随地使用计算机的需要。

用户指南

为帮助您设置和使用 Acer 笔记本电脑，我们为您设计了以下用户指南：

首先，请按照电脑所附带的**安装彩图**来安装电脑。

TravelMate 系列普通用户指南包含了关于 TravelMate 产品系列所有型号的有用信息。该手册包括键盘和音频的使用方法等基本内容。请注意，鉴于手册的性质，下文所提之 **AcerSystem 用户指南**偶尔也会提及本系列产品中部分型号专有的功能或特性，但您购买的型号不一定具有这些功能或特性。以上情况会以仅限部分型号等字样在文中注明。

本**快速指南**介绍了您新购电脑的基本特性和功能。要了解您的电脑如何能够帮助您更加具有效益详情，请参见 **AcerSystem User Guide**。本指南包含了诸如系统实用程序、数据恢复、扩展选项和疑难解答等信息。此外，它还包含了保修信息和笔记本电脑的一般规则和安全注意事项，我们也提供了 PDF 格式的用户指南并已预先安装在本电脑中供用户参考，按这些步骤访问：

- 1 单击**开始 > 所有程序 > AcerSystem**。
- 2 单击 **AcerSystem User's Guide**。



注：查看 PDF 文件需要预先安装 Adobe Reader。如果您的电脑没有预先安装 Adobe Reader 单击 **“AcerSystem User's Guide”** 后将会先启动 Adobe Reader 安装程序。依屏幕上指导完成安装程序，要获得如何使用 Adobe Reader 的指导，请使用 **“帮助和支持”** 菜单。

熟悉 Acer 笔记本电脑

当您按照入门指南海报上的图示安装完电脑后，就让我们一起来熟悉您的 Acer 笔记本电脑。

俯视图

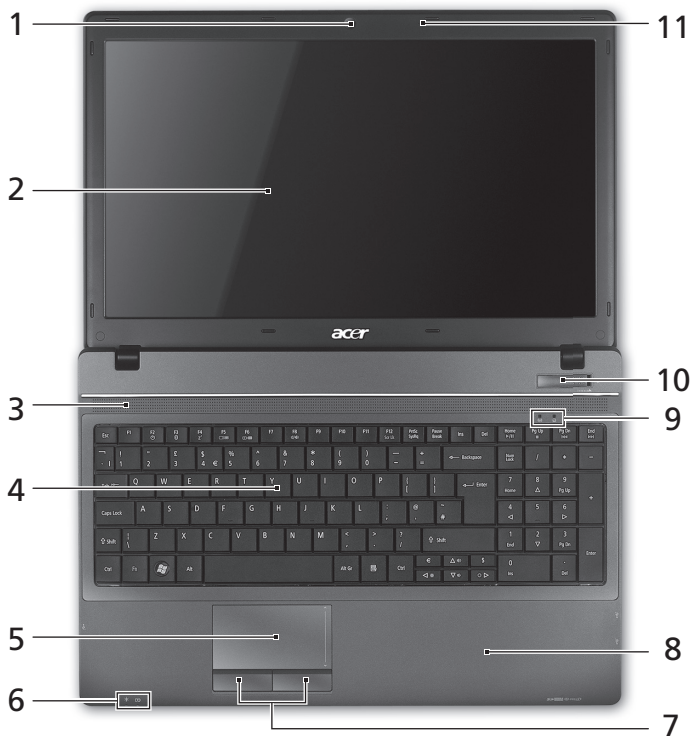

#	图标	项目	描述
1		Acer Crystal Eye 摄像头	网络相机，用于视频通信（仅限部分型号）。
2		显示屏	也称液晶显示屏 (Liquid-Crystal Display ; LCD)，用于显示电脑的输出内容（不同型号配置可能有所不同）。
3		扬声器	前面左右扬声器可提供立体声输出。
4		键盘	将数据输入到电脑中。
5		触控板	触摸式定位设备，功能和电脑鼠标相同。
6		电源指示灯 ¹	表示计算机的电源状态。
		电池指示灯 ¹	表示计算机的电池状态。 1. 充电中： 当电池在充电时，指示灯显示琥珀色。 2. 完全充电： 当处在 AC 模式时，指示灯显示蓝色。
7		单击按钮（左和右）	左右按钮的功能与鼠标的左右键相同。
8		掌垫板	当您使用电脑时，可舒适支撑手部的区域。
9		HDD	硬盘活动时，该指示灯亮。
		通信指示灯	表示计算机的无线连接设备状态。
10		电源开关	用于打开和关闭计算机电源。
11		麦克风	用于录音的内置麦克风。

1. 即使计算机外盖合上，也能看到前面板的状态指示灯。

热键

本款电脑提供热键或组合键来实现许多操控，例如：调节屏幕亮度以及音量输出。

要激活热键，先按住 <Fn> 键，然后再按热键组合中的另一个键。

热键	图标	功能	描述
<Fn> + <F3>		通信	启用 / 禁用计算机的通信设备。 (通信设备根据配置可能有所不同。)
<Fn> + <F4>		睡眠	让电脑进入睡眠模式。
<Fn> + <F5>		显示屏幕切换	可以在以下三种显示方式间切换： 只使用显示屏、只使用已连接的外部显示器、同时使用显示屏和外部显示器。
<Fn> + <F6>		显示屏关闭	关闭显示屏背光以节省电量。按任意键将恢复正常显示。
<Fn> + <F7>		触摸板切换	打开和关闭触摸板。
<Fn> + <F8>		扬声器切换	打开或关闭扬声器。
<Fn> + <△>		调高音量	调高扬声器音量。
<Fn> + <▽>		调低音量	调低扬声器音量。
<Fn> + <◇>		调高亮度	调高屏幕亮度。
<Fn> + <◁>		调低亮度	调低屏幕亮度。

前视图



#	图标	项目	描述
1		电源指示灯 ¹	表示计算机的电源状态。
		电池指示灯 ¹	表示计算机的电池状态。 1. 充电中: 当电池在充电时, 指示灯显示琥珀色。 2. 完全充电: 当处在 AC 模式时, 指示灯显示蓝色。
2		多合 1 读卡器	可支持 Secure Digital (SD)、MultiMediaCard (MMC)、Memory Stick (MS)、Memory Stick PRO (MS PRO)、xD-Picture Card (xD)。 注: 轻推取下 / 安装卡。任何时候, 仅支持读取一张卡。

后视图

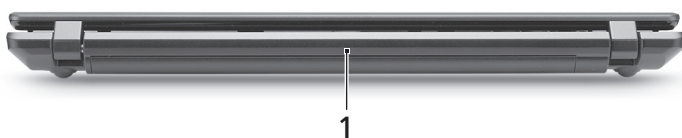

#	图标	项目	描述
1		电池	未插接电源插头时为计算机供电。

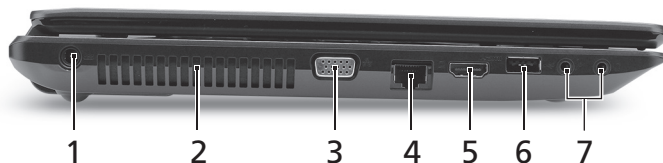

左视图



#	图标	项目	描述
1		直流电源输入插孔	连接交流适配器。
2		通风槽	可使电脑在长时间使用后仍保持低温。
3		外部显示器 (VGA) 端口	连接显示设备 (例如: 外接显示器、LCD 投影机)。
4		以太网 (RJ-45) 端口	连接 10/100/1000 以太网网络。
5		HDMI 端口	支持高清数字视频连接。
6		USB 2.0 端口	连接 USB 2.0 设备 (例如: USB 鼠标、USB 相机)。
7		麦克风输入插孔	连接外接麦克风。
		耳机 / 扬声器 / 音频输出插孔	连接音频输出设备 (例如: 扬声器、耳机)。

右视图





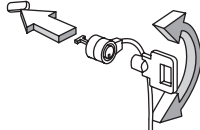

#	图标	项目	描述
1		USB 2.0 端口	连接 USB 2.0 装置 (例如: USB 鼠标、USB 相机)。
2		光驱	内置光驱, 可支持读取 CD 或 DVD。
3		光驱访问指示灯	当光驱被激活时指示灯会亮起。
4		光驱弹出按钮	按下此按钮可弹出光驱。
5		紧急弹出孔	当电脑关闭时, 可弹出光驱托盘。 注: 如果计算机关闭, 请将回形针插入紧急弹出孔, 使光驱弹出。
6		Kensington 安全锁插槽	连接 Kensington 兼容电脑安全锁。 注: 您可以将电脑锁链与不可移动的物体相连, 例如: 桌子或上锁的抽屉手柄。将锁插入锁孔中然后旋转钥匙便可上锁。您也可以选购不带安全锁的型号。

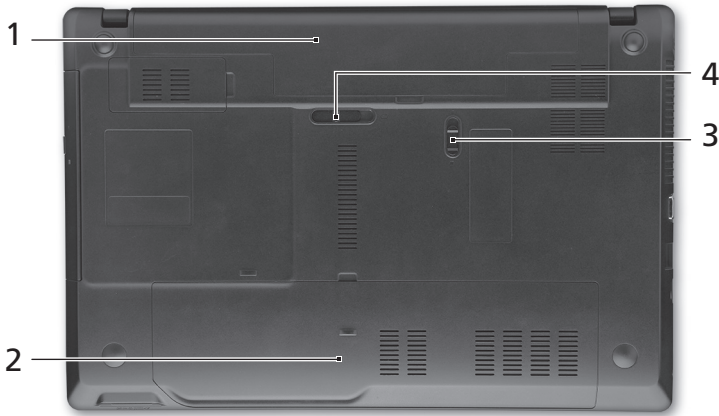

底视图



#	图标	项目	描述
1		电池槽	安装电池组。
2		硬盘槽	安装电脑硬盘的位置（用螺丝紧固）。
		内存槽	安装电脑主内存的位置。
3		电池锁	可固定锁紧电池组。
4		电池释放门锁	释放电池门锁可取下电池组。

环境

- 温度：
 - 操作时：5°C 至 35°C
 - 不操作时：-20°C 至 65°C
- 湿度（非冷凝）：
 - 操作时：20% 至 80%
 - 不操作时：20% 至 80%

Seri TravelMate 5740/ 5740Z/5340

Panduan cepat

© 2010 Hak Cipta Dilindungi Undang-Undang.

Panduan Cepat Seri TravelMate 5740/5740Z/5340
Edisi Pertama: 03/2010

PC Notebook Seri TravelMate 5740/5740Z/5340

Nomor model: _____

Nomor seri: _____

Tanggal pembelian: _____

Alamat pembelian: _____

Informasi penting

Kami mengucapkan terima kasih kepada Anda yang telah memilih notebook Acer untuk memenuhi kebutuhan Anda akan komputer bergerak.

Panduan Anda

Untuk membantu Anda menggunakan notebook Acer, kami menyediakan kumpulan panduan sebagai berikut:

Pertama-tama, **lembar petunjuk penyiapan** ini membantu Anda mulai melakukan setup atau penyiapan komputer Anda.

Panduan Pengguna Generik Seri TravelMate berisi informasi berguna yang berlaku untuk semua model dalam seri produk TravelMate. Panduan ini mencakup topik-topik dasar seperti, menggunakan keyboard, audio, dsb. Mohon dimengerti bahwa karena sifatnya, **AcerSystem User Guide** [Buku Petunjuk AcerSystem] yang disebutkan di bawah ini kadang-kadang mengacu pada fungsi atau fitur yang hanya terdapat dalam model tertentu dalam seri ini, tetapi tidak terdapat dalam model yang telah Anda beli. Hal-hal seperti itu dalam teks ditandai dengan kata-kata seperti "hanya untuk model-model tertentu".

Panduan cepat ini menjelaskan fitur dan fungsi dasar komputer baru Anda. Untuk informasi lebih lanjut tentang cara komputer ini membantu Anda agar lebih produktif, lihat **AcerSystem User Guide** [Buku Petunjuk AcerSystem]. Petunjuk ini berisi informasi rinci tentang topik, seperti utilitas sistem, pemulihan data, opsi-opsi ekspansi, dan pemecahan masalah. Di samping itu, panduan ini berisi informasi jaminan dan peraturan umum serta peringatan keselamatan untuk notebook Anda. Panduan tersebut tersedia dalam format PDF dan sudah tersedia dalam notebook Anda. Ikuti langkah ini untuk mengaksesnya:

- 1 Klik pada **Mulai > Semua Program > AcerSystem**.
- 2 Klik pada **AcerSystem User Guide** [Buku Petunjuk AcerSystem].



.....

Catatan: Adobe Reader diperlukan untuk melihat file tersebut. Jika Adobe Reader belum diinstal dalam komputer Anda, klik pada **AcerSystem User Guide** [Buku Petunjuk AcerSystem] untuk menjalankan program konfigurasi Adobe Reader terlebih dulu. Ikuti petunjuk pada layar untuk melakukan instalasi tersebut. Untuk petunjuk tentang cara menggunakan Adobe Reader, akses menu **Bantuan dan Dukungan**.

Tur Acer notebook Anda

Setelah mempersiapkan komputer seperti pada gambar dalam brosur **Untuk Permulaan...**, kami akan menunjukkan bagian-bagian notebook Acer.

Pandangan atas

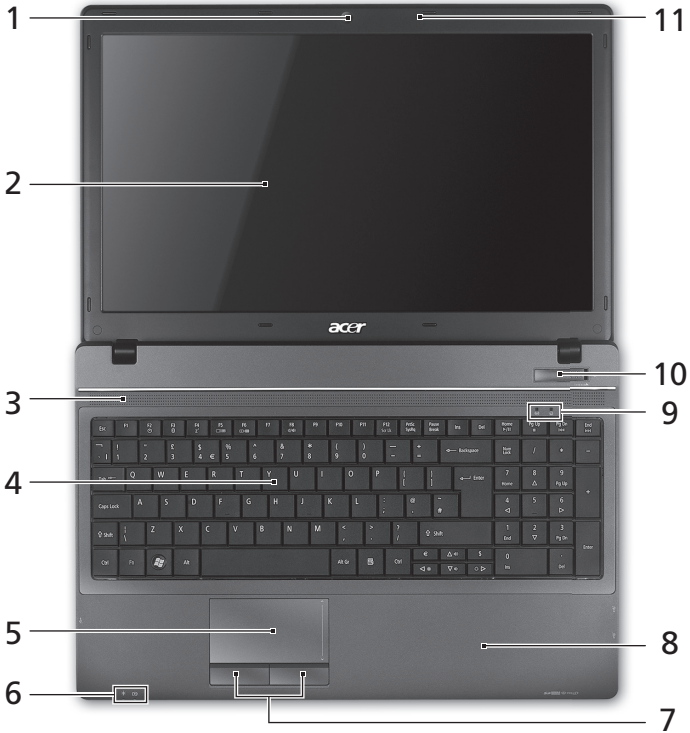



#	Ikon	Item	Keterangan
1		Webcam Acer Crystal Eye	Webcam untuk komunikasi video (hanya untuk model-model tertentu).
2		Layar tampilan	Disebut juga sebagai LCD (Liquid-Crystal Display), akan menampilkan output komputer (Konfigurasi mungkin berbeda tergantung model).
3		Pengeras suara	Pengeras suara kiri depan dan kanan depan menghadirkan keluaran audio stereo.
4		Keyboard	Untuk memasukkan data ke komputer.
5		Panel sentuh	Perangkat penunjuk sensitif sentuhan yang berfungsi seperti mouse komputer.
6		Indikator daya ¹	Menunjukkan status daya komputer.
		Indikator baterai ¹	Menunjukkan status baterai komputer. 1. Mengisi daya: Lampu akan menyala kuning kecokelatan bila daya baterai sedang diisi. 2. Daya terisi penuh: Lampu menyala biru bila dalam mode AC.
7		Tombol klik (kiri dan kanan)	Tombol kiri dan kanan berfungsi seperti tombol mouse kiri dan kanan.
8		Tempat tangan	Tempat nyaman untuk meletakkan tangan Anda sewaktu menggunakan komputer.
9		HDD	Menunjukkan bila drive hard disk aktif.
		Indikator komunikasi	Menunjukkan status perangkat konektivitas nirkabel komputer.
10		Tombol daya	Menghidupkan/mematikan komputer.
11		Mikrofon	Mikrofon internal untuk perekaman suara.

1. Indikator panel depan akan terlihat meskipun penutup komputer dalam keadaan tertutup.

Tombol pintas



Komputer menggunakan tombol pintas atau kombinasi tombol untuk mengakses sebagian besar kontrol komputer, misalnya kecerahan layar dan output volume suara.

Untuk mengaktifkan tombol pintas, tekan terus tombol **<Fn>** sebelum menekan tombol lain pada kombinasi tombol pintas.

Tombol pintas	Ikona	Fungsi	Keterangan
<Fn> + <F3>		Komunikasi	Mengaktifkan/menonaktifkan perangkat komunikasi komputer. (Perangkat komunikasi mungkin berbeda-beda berdasarkan konfigurasinya.)
<Fn> + <F4>		Sleep	Mengaktifkan komputer dalam mode Sleep.
<Fn> + <F5>		Toggle layar	Mengalihkan output tampilan antara layar tampilan, monitor eksternal (jika dipasang), dan keduanya.
<Fn> + <F6>		Tampilan mati	Menonaktifkan cahaya latar layar tampilan untuk menghemat daya. Tekan tombol apa saja untuk kembali.
<Fn> + <F7>		Tombol panel sentuh	Mengaktifkan/menonaktifkan panel sentuh.
<Fn> + <F8>		Tombol speaker	Mengaktifkan dan menonaktifkan speaker.
<Fn> + <Δ>		Volume naik	Menaikkan volume.
<Fn> + <▽>		Volume turun	Menurunkan volume.
<Fn> + <◇>		Kecerahan meningkat	Meningkatkan kecerahan layar.
<Fn> + <◁>		Kecerahan berkurang	Mengurangi kecerahan layar.

Pandangan depan tertutup



#	Ikon	Item	Keterangan
1		Indikator daya ¹	Menunjukkan status daya komputer.
		Indikator baterai ¹	Menunjukkan status baterai komputer. 1. Mengisi daya: Lampu akan menyala kuning kecokelatan bila daya baterai sedang diisi. 2. Daya terisi penuh: Lampu menyala biru bila dalam mode AC.
2		Pembaca kartu Multi-in-1	Menerima Secure Digital (SD), MultiMediaCard (MMC), Memory Stick (MS), Memory Stick PRO (MS PRO), xD-Picture Card (xD). Catatan: Tekan untuk melepas/memasang kartu. Hanya satu kartu yang bisa beroperasi saat Anda menggunakannya.







Tampilan belakang

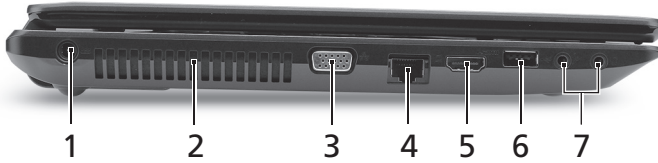

#	Ikon	Item	Keterangan
1		Baterai	Memberi daya bagi komputer untuk digunakan ketika dicabut dari stopkontak.



Pandangan kiri



#	Ikon	Item	Keterangan
1		Jack DC-in	Menghubungkan ke Adaptor AC.
2		Slot ventilasi	Membuat komputer tetap dingin, bahkan setelah pemakaian yang lama.
3		Port tampilan (VGA) eksternal	Menghubungkan perangkat tampilan (mis., monitor eksternal, proyektor LCD).
4		Port ethernet (RJ-45)	Menghubungkan ke jaringan berbasis ethernet 10/100/1000.
5		Port HDMI	Mendukung koneksi video digital definisi tinggi.
6		Port USB 2.0	Menghubungkan ke perangkat USB 2.0 (mis., mouse USB, kamera USB).
7		Jack mikrofon-in	Menerima input dari mikrofon eksternal.
		Jack headphone/ penguat suara/ line-out	Menghubungkan ke perangkat sambungan keluar audio (misalnya, speaker, headphone).

Pandangan kanan





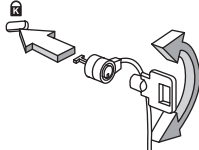

#	Ikon	Item	Keterangan
1		Port USB 2.0	Menyambung ke perangkat USB 2.0 (misalnya, mouse USB, kamera USB).
2		Drive optik	Drive optik internal; menerima CD atau DVD.
3		Indikator akses disket optik	Menyala saat drive optik aktif.
4		Tombol pelepas drive optik	Mengeluarkan disk optik dari drive.
5		Lubang pelepas darurat	Melepas tempat drive optik saat komputer mati. Catatan: Masukkan klip kertas ke lubang pengeluaran darurat untuk mengeluarkan tray drive optik bila komputer mati.
6		Slot kunci Kensington	Menghubungkan ke kunci keamanan komputer yang kompatibel dengan kunci Kensington. Catatan: Lilitkan kabel kunci keamanan komputer ke benda sekitar yang tidak dapat bergerak, misalnya, meja atau gagang laci yang terkunci. Masukkan kunci ke dalam lubang, kemudian putar kunci untuk menguncinya. Beberapa model tanpa kunci juga tersedia.

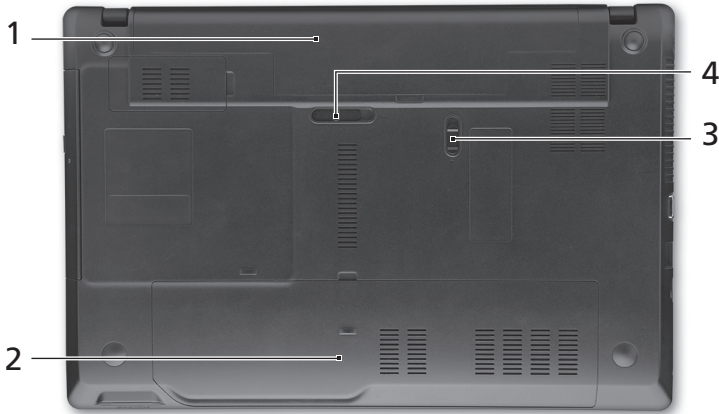

Tampilan bawah



#	Ikon	Item	Keterangan
1		Tempat baterai	Tempat kemasan baterai komputer.
2		Bay hard disk	Untuk memasang hard disk komputer (dipasang dengan sekrup).
		Kompartemen memori	Untuk memasang memori utama komputer.
3		Kunci baterai	Mengunci baterai pada tempatnya.
4		Penutup pelepas baterai	Untuk melepaskan baterai.

Lingkungan

- Suhu:
 - Beroperasi: 5°C hingga 35°C
 - Tidak beroperasi: -20°C hingga 65°C
- Kelembaban (non-kondensasi):
 - Beroperasi: 20% hingga 80%
 - Tidak beroperasi: 20% hingga 80%

ซีรีส์ TravelMate 5740/
5740Z/5340

คู่มืออย่างย่อ

© 2010 สงวนลิขสิทธิ์

คู่มืออย่างย่อ ซีรีส์ TravelMate 5740/5740Z/5340
คนฉบับ: 03/2010

โน้ตบุ๊กพีซี ซีรีส์ TravelMate 5740/5740Z/5340

หมายเลขรุ่น: _____

ซีเรียลนัมเบอร์: _____

วันที่ซื้อ: _____

สถานที่ซื้อ: _____

ก่อนอื่น

ขอขอบคุณที่คุณเลือกโน้ตบุ๊กจาก Acer เพื่อรองรับการใช้งานแบบพกพาของคุณ

คู่มือ

เพื่อช่วยสอนการใช้โน้ตบุ๊ก Acer เราจึงได้จัดทำคู่มือชุดนี้ขึ้น

อันดับแรกคือ **โปสเตอร์การติดตั้ง**ที่จะช่วยคุณในการเริ่มใช้คอมพิวเตอร์ของคุณ

คู่มือผู้ใช้ทั่วไปเกี่ยวกับ **TravelMate** ซีรีส์ประกอบไปด้วยข้อมูลที่เป็นประโยชน์สำหรับผลิตภัณฑ์ตระกูล TravelMate ทุกรุ่น โดยระบุรายการทำงานเบื้องต้นต่าง ๆ เช่น การใช้คีย์บอร์ด ระบบเสียง ฯลฯ เนื่องจากการจัดทำคู่มือแบบครอบคลุมรวม **AcerSystem User Guide** ซึ่งจะกล่าวถึงต่อไปนี้อาจมีฟังก์ชันหรือคุณสมบัติต่าง ๆ ที่มีอยู่เฉพาะในผลิตภัณฑ์บางรุ่นเท่านั้น ซึ่งอาจไม่รวมถึงผลิตภัณฑ์รุ่นที่คุณจัดซื้อ ตัวอย่างเช่นมีการแจ้งให้ทราบเป็นข้อความที่ระบุเฉพาะเจาะจงอย่าง "สำหรับบางรุ่น"

คู่มืออย่างย่อ เป็นข้อมูลคุณสมบัติและฟังก์ชันเบื้องต้นในคอมพิวเตอร์เครื่องใหม่ของคุณ

สอบถามข้อมูลการใช้งานคอมพิวเตอร์เพื่อให้เกิดประสิทธิภาพสูงสุดได้จาก **AcerSystem User Guide**

คู่มือนี้ประกอบไปด้วยข้อมูลโดยละเอียดเกี่ยวกับหัวข้อต่างๆ เช่นโปรแกรมมอรรถประโยชน์ต่างๆ ของระบบ, การกู้คืนข้อมูล, ทางเลือกในการเพิ่มขยาย และวิธีการแก้ไขปัญหา นอกจากนี้ยังประกอบด้วยข้อมูลการรับประกัน ข้อบังคับทั่วไป และการแจ้งเตือนด้านความปลอดภัยสำหรับโน้ตบุ๊กของคุณ ซึ่งมีให้ในรูปแบบ Portable Document Format (PDF) และมาพร้อมกับโน้ตบุ๊กของคุณ ทำตามขั้นตอนดังต่อไปนี้เพื่อเรียกดู

- 1 คลิกที่ **เริ่ม > โปรแกรมทั้งหมด > AcerSystem**
- 2 คลิกที่ **AcerSystem User Guide**







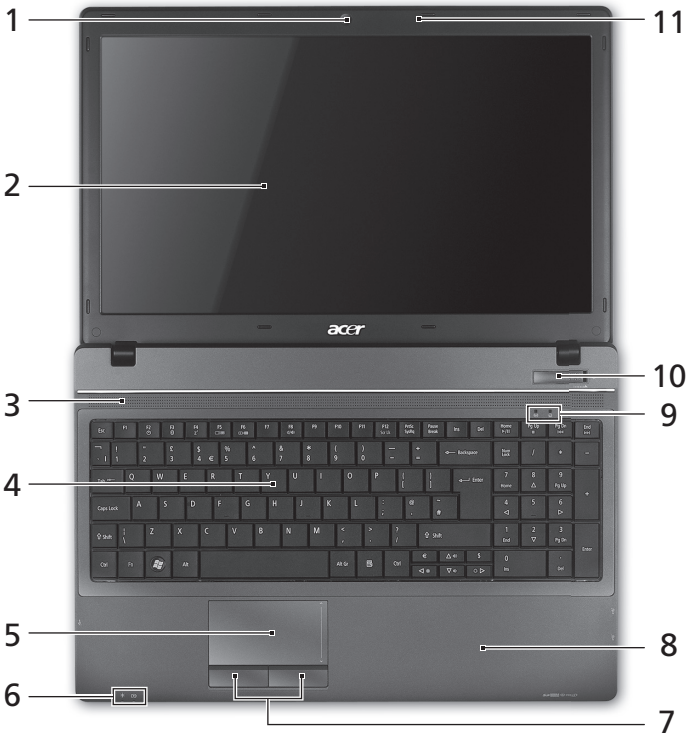

หมายเหตุ: การดูไฟล์นี้จำเป็นต้องใช้ Adobe Reader ในกรณีที่ไม่ได้ติดตั้ง Adobe Reader ไว้ในคอมพิวเตอร์ กรุณาคลิกที่ **AcerSystem User Guide** จากนั้นโปรแกรมติดตั้ง Adobe Reader จะเปิดขึ้น ทำตามคำแนะนำบนจอแสดงผลเพื่อติดตั้งให้เสร็จสมบูรณ์ สำหรับขั้นตอนวิธีการใช้ Adobe Reader ให้เรียกดูได้จากเมนู **Help and Support (วิธีใช้และการสนับสนุน)**

แนะนำเกี่ยวกับโน้ตบุ๊ค Acer ของคุณ

หลังจากติดตั้งคอมพิวเตอร์ตามภาพในโปสเตอร์ ข้อมูลสำหรับผู้เริ่มต้นใช้งานต่อไปนี้เป็นวิธีการใช้งานโน้ตบุ๊ค Acer ใหม่ของคุณ

มุมมองด้านบน



#	ไอคอน	รายการ	คำอธิบาย
1		เว็บแคม Acer Crystal Eye	กล้องเว็บแคมสำหรับระบบการสื่อสารด้วยวิดีโอ (สำหรับบางรุ่น)
2		จอแสดงผล	หรือ Liquid-Crystal Display (LCD) ใช้แสดงข้อมูลต่าง ๆ ของคอมพิวเตอร์ (ส่วนประกอบอาจแตกต่างกันไปตามรุ่น)
3		ลำโพง	ลำโพงซ้ายหน้าและขวาหน้าจ่ายสัญญาณเสียงระบบสเตอริโอ
4		คีย์บอร์ด	เพื่อป้อนข้อมูลเข้าสู่คอมพิวเตอร์ของคุณ
5		ทัชแพด	อุปกรณ์ชี้ตำแหน่งแบบสัมผัส ซึ่งทำงานแบบเดียวกับเมาส์คอมพิวเตอร์
6		ตัวแสดงสถานะเปิดปิด ¹	ระบุสถานะการเปิดใช้งานคอมพิวเตอร์
		ตัวแสดงสถานะแบตเตอรี่ ¹	แสดงถึงสถานะแบตเตอรี่ของคอมพิวเตอร์ 1. กำลังชาร์จ: ไฟสว่างเป็นสีเหลืองอำพันเมื่อทำการชาร์จแบตเตอรี่ 2. ชาร์จไฟเต็ม: ไฟสีน้ำเงินติดสว่างขณะอยู่ในโหมด AC
7		ปุ่มคลิก (ซ้ายและขวา)	ปุ่มซ้ายและขวาทำงานเหมือนกับปุ่มเมาส์ซ้ายและขวา
8		ที่วางมือ	พื้นที่รองรับมือเพื่อให้รู้สึกสบายขณะใช้คอมพิวเตอร์
9		HDD	แสดงเมื่อฮาร์ดดิสก์ไดรฟ์มีการทำงาน
		ไฟแสดงสถานะการสื่อสาร	แสดงถึงสถานะอุปกรณ์เชื่อมต่อแบบไร้สายของคอมพิวเตอร์
10		สวิตช์เปิดปิด	เปิดและปิดคอมพิวเตอร์
11		ไมโครโฟน	ไมโครโฟนในตัวสำหรับการบันทึกเสียง

1. สัญลักษณ์ที่แฉงด้านหน้าสามารถมองเห็นได้แม้จะปิดฝาพับคอมพิวเตอร์

ปุ่มลัด



คอมพิวเตอร์จะมีคีย์ลัดหรือชุดแป้นกดเพื่อเข้าใช้งานส่วนควบคุมต่าง ๆ ของคอมพิวเตอร์ เช่น ความสว่างของหน้าจอและระดับเสียง

เพื่อเปิดใช้งานฮอตคีย์ ให้กดปุ่ม <Fn> ค้างเอาไว้ก่อนที่จะกดปุ่มอื่นในชุดฮอตคีย์

ฮอตคีย์	ไอคอน	ฟังก์ชัน	คำอธิบาย
<Fn> + <F3>		การสื่อสาร	เปิด/ปิด อุปกรณ์สื่อสารของคอมพิวเตอร์ (อุปกรณ์สื่อสารอาจแตกต่างกันตามรูปแบบการติดตั้งใช้งาน)
<Fn> + <F4>		สลีป	ตั้งคอมพิวเตอร์ให้อยู่ในโหมดสลีป
<Fn> + <F5>		สลับจอแสดงผล	สลับเอาที่พู่จอแสดงผลระหว่างหน้าจอแสดงผล, จอแสดงผลภายนอก (หากเชื่อมต่ออยู่) และทั้งสองชนิด
<Fn> + <F6>		ปิดการแสดงผล	ปิดไฟพื้นหลังจอแสดงผลเพื่อประหยัดพลังงาน กดปุ่มได้ก็เพื่อเปิดหน้าจอกลับมาอีกครั้ง
<Fn> + <F7>		เปิดปิดการใช้งานทัชแพด	เปิดและปิดทัชแพด
<Fn> + <F8>		เปิดปิดลำโพง	เปิดและปิดลำโพง
<Fn> + <Δ>		เพิ่มเสียง	เพิ่มระดับเสียง
<Fn> + <▽>		ลดเสียง	ลดระดับเสียง
<Fn> + <▷>		เพิ่มความสว่าง	เพิ่มความสว่างของหน้าจอ
<Fn> + <◁>		ลดความสว่าง	ลดความสว่างของหน้าจอ

ปิดมุมมองด้านบน



#	ไอคอน	รายการ	คำอธิบาย
1		ตัวแสดงสถานะเปิดปิด ¹	ระบุสถานะการเปิดใช้งานคอมพิวเตอร์
		ตัวแสดงสถานะแบตเตอรี่ ¹	แสดงถึงสถานะแบตเตอรี่ของคอมพิวเตอร์ 1. กำลังชาร์จ: ไฟสว่างเป็นสีเหลืองอำพันเมื่อทำการชาร์จแบตเตอรี่ 2. ชาร์จไฟเต็ม: ไฟสีน้ำเงินติดสว่างขณะอยู่ในโหมด AC
2		การ์ดรีดเดอร์มัลติมีเดีย	สามารถใช้งานร่วมกับ Secure Digital (SD), MultiMediaCard (MMC), Memory Stick (MS), Memory Stick PRO (MS PRO), xD-Picture Card (xD) หมายเหตุ: กดเพื่อถอด/ใส่การ์ด ใช้งานการ์ดได้ครั้งละหนึ่งชุดเท่านั้น







มุมมองด้านหลัง

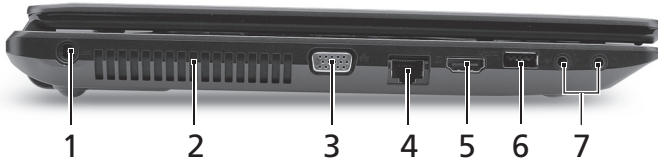

#	ไอคอน	รายการ	คำอธิบาย
1		แบตเตอรี่	ให้พลังงานกับคอมพิวเตอร์เพื่อใช้เมื่อไม่ได้เสียบปลั๊ก



มุมมองด้านซ้าย



#	ไอคอน	รายการ	คำอธิบาย
1		ช่องเสียบ DC-in	เชื่อมต่อกับอะแดปเตอร์ AC
2		ช่องระบายอากาศ	ช่วยให้คอมพิวเตอร์เย็น แม้อัปเดตจากใช้งานเป็นเวลานาน
3		พอร์ตจอแสดงผลต่อพ่วง (VGA)	เชื่อมต่อกับจอแสดงผล (เช่น จอภาพภายนอก, โปรเจคเตอร์ LCD)
4		พอร์ต Ethernet (RJ-45)	เชื่อมต่อเครือข่าย Ethernet 10/100/1000
5		พอร์ต HDMI	รองรับการเชื่อมต่อระบบวิดีโอดิจิทัลความละเอียดสูง
6		พอร์ต USB 2.0	ต่ออุปกรณ์ USB 2.0 (เช่น เมาส์หรือกล้อง USB)
7		แจ๊คเสียบไมโครโฟน	ใช้สำหรับต่อไมโครโฟน
		ช่องเสียบหูฟัง/ลำโพง/line-out	ใช้สำหรับต่ออุปกรณ์เสียงขาออก (เช่น ลำโพง ชุดหูฟัง)

มุมมองด้านขวา





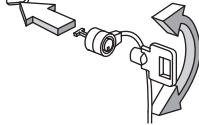

#	ไอคอน	รายการ	คำอธิบาย
1		พอร์ต USB 2.0	ต่ออุปกรณ์ USB 2.0 (เช่น เม้าส์หรือกล้อง USB)
2		ไดร์ฟออปติคัล	ไดร์ฟออปติคัลภายใน สำหรับใส่ CD หรือ DVD
3		ไฟแสดงการอ่านออปติคัล ลติสก์	ติดสว่างเมื่อมีการอ่านแผ่นออปติคัล
4		ปุ่มติดแผ่นออปติคัลออก	นำแผ่นออปติคัลออกจากไดร์ฟ
5		ปุ่มนำแผ่นออกฉุกเฉิน	ใช้เปิดถาดใส่แผ่นออปติคัลขณะปิดคอมพิวเตอร์ หมายเหตุ: สอดคลิปหนีบกระดาษเข้าในช่องนำแผ่นออกฉุกเฉิน เพื่อเปิดถาดใส่แผ่นออปติคัลขณะปิดคอมพิวเตอร์อยู่
6		สล๊อตล็อก Kensington	เชื่อมต่อกับระบบล็อกความปลอดภัยสำหรับคอมพิวเตอร์ที่ มีความเข้ากันได้กับ Kensington หมายเหตุ: คล้องสายล็อกป้องกันคอมพิวเตอร์กับส่วนประกอบที่ยึดต าย เช่น โต๊ะ มือจับหรือลิ้นชักที่ล็อกอยู่ ใส่ตัวล็อกลงในร่องบากและหมุนตัวล็อกไปยังตำแหน่งล็อก ในบางรุ่นอาจไม่มีระบบล็อกนี้

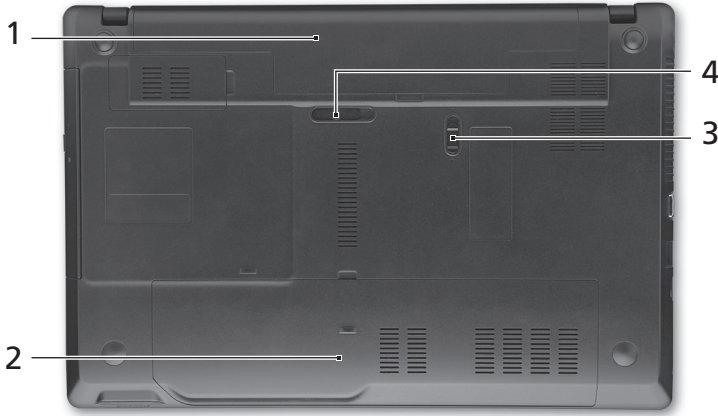

มุมมองด้านล่าง



#	ไอคอน รายการ	คำอธิบาย
1	ช่องใส่แบตเตอรี่	ใช้สำหรับเก็บแพ็คแบตเตอรี่ของคอมพิวเตอร์
2	 ช่องใส่ฮาร์ดดิสก์	ที่อยู่ของฮาร์ดดิสก์ของคอมพิวเตอร์ (ยึดติดแน่นด้วยน็อต)
	 ช่องหน่วยความจำ	ที่อยู่ของหน่วยความจำของคอมพิวเตอร์
3	 ล็อคแบตเตอรี่	ล็อคแบตเตอรี่ให้อยู่ในตำแหน่ง
4	 สลักปลดล็อคแบตเตอรี่	ปลดล็อคเพื่อนำแบตเตอรี่ออก

สิ่งแวดล้อม

- อุณหภูมิ:
 - ขณะทำงาน: 5°C ถึง 35°C
 - ขณะไม่ได้ใช้งาน: -20°C ถึง 65°C
- ความชื้น (ไม่ควบนั่นเป็นไอน้ำ):
 - ขณะทำงาน: 20% ถึง 80%
 - ขณะไม่ได้ใช้งาน: 20% ถึง 80%