

acer



ICONIA SMART

User Guide

Acer ICONIA SMART User Guide

Model: S300

Original issue: 08/2011

Acer ICONIA SMART

Model number: _____

Serial number: _____

Date of purchase: _____

Place of purchase: _____

Table of Contents

End User License Agreement

Features and functions	7
Product registration	7

Setting Up

Unpacking your smartphone	8
Getting to know your smartphone	8
Installing a SIM and optional microSD Card	10
Installing or removing the battery	11

Using your Smartphone

Turning on for the first time	13
Locking your smartphone	13
Using the touchscreen	14
The Idle screen	16
The Home screen	17

Managing contacts

Managing your contacts	23
------------------------------	----

Making Calls

Before making a call	25
Making a call	25
The voice call screen	27

Internet Calling

Adding an Internet calling account	29
Editing or removing an Internet calling account	29
Using Internet calling	29
Receiving Internet calls	29
Calling a contact's Internet calling address	29
Calling a phone number using Internet calling	29

Messaging

Creating a new message	30
Replying to a message	31
MMS messages	31
Social messages	32

Going online

Browsing the Internet	33
-----------------------------	----

Setting up Gmail	34
Composing an email	34
Setting up Email	35
Acer SocialJogger	36
Maps, Navigation, Places and Latitude	37
Using the Camera	
Camera icons and indicators	38
Taking a photo	39
Shooting a video	41
Viewing photos and videos	41
Geotagging	41
Advanced Settings	
Putting your smartphone in Airplane mode	42
Adjusting settings	42
Connecting to a PC	45
Acer USB Fast Charge	46
FM radio	47
Multimedia playback	47
Restoring to factory settings	51
Accessories and Tips	
Using the headset	52
Using a Bluetooth headset	52
HDMI and 720P output	52
Inserting a microSD Card	53
Appendix	
FAQ and troubleshooting	54
Other sources of help	55
Warnings and precautions	55
Emergency calls	58
Disposal and recycling information	58
Taking care of your smartphone	59
Specifications	60
Regulatory information	62

End User License Agreement

IMPORTANT-READ CAREFULLY: THIS END USER LICENSE AGREEMENT ("AGREEMENT") IS A LEGAL AGREEMENT BETWEEN YOU (EITHER AN INDIVIDUAL OR A SINGLE ENTITY), AND ACER INC. INCLUDING ITS SUBSIDIARIES ("ACER") FOR THE SOFTWARE (WHETHER PROVIDED BY ACER OR BY ACER'S LICENSORS OR SUPPLIERS) THAT ACCOMPANIES THIS AGREEMENT, INCLUDING ANY ASSOCIATED MEDIA, PRINTED MATERIALS AND RELATED USER ELECTRONIC DOCUMENTATION WHICH MAY BE BRANDED "ACER" ("SOFTWARE"). AGREEMENTS RELATING TO ANY OTHER PRODUCT OR TOPIC ARE NEITHER INTENDED NOR SHOULD THEY BE IMPLIED. BY INSTALLING THE ACCOMPANYING SOFTWARE OR ANY PORTION THEREOF, YOU AGREE TO BE BOUND BY THE TERMS AND CONDITIONS OF THIS AGREEMENT. IF YOU DO NOT AGREE TO ALL OF THE TERMS AND CONDITIONS OF THIS AGREEMENT, DO NOT CONTINUE THE INSTALLATION PROCESS AND IMMEDIATELY DELETE ALL INSTALLED FILES, IF ANY, OF THE ACCOMPANYING SOFTWARE FROM YOUR PHONE.

IF YOU DO NOT HAVE A VALIDLY-LICENSED COPY OF THE APPLICABLE SOFTWARE, YOU ARE NOT AUTHORIZED TO INSTALL, COPY OR OTHERWISE USE THE SOFTWARE, AND HAVE NO RIGHTS UNDER THIS AGREEMENT.

The Software is protected by U.S. and international copyright laws and conventions as well as other intellectual property laws and treaties. The Software is licensed, not sold.

GRANT OF LICENSE

Acer grants to you the following non-exclusive and non-transferable rights with respect to the Software. Under this Agreement, you may:

1. Install and use the Software only on a single designated phone. A separate license is required for each phone on which the Software will be used;
2. Make one copy of the Software solely for backup or archival purposes;
3. Make one hardcopy of any electronic documents included in the Software, provided that you receive the documents electronically.

RESTRICTIONS

You may NOT:

1. Use or copy the Software except as provided in this Agreement;
2. Rent or lease the Software to any third party;
3. Modify, adapt, or translate the Software in whole or in part;
4. Reverse engineer, decompile, or disassemble the Software or create derivative works based upon the Software;
5. Merge the Software with any other program or modify the Software, except for your personal use; and
6. Sublicense or otherwise make the Software available to third parties, except that you may, after prior written notification to Acer, transfer the Software as a whole to a third party so long as you do not retain any copies of the Software and such third party accepts the terms of this Agreement.
7. Transfer your rights under this Agreement to any third parties.
8. Export the Software in contravention of applicable export laws and regulations, or (i) sell, export, re-export, transfer, divert, disclose technical data, or dispose of, any Software to any prohibited person, entity, or destination including, without limitation, Cuba, Iran, North Korea, Sudan and Syria; or (ii) use any Software for any use prohibited by the laws or regulations of the United States.

SUPPORT SERVICES

Acer is not obligated to provide technical or other support for the Software.

ACER LIVE UPDATE

Certain of the software contains elements that enable the use of the Acer Live Update service, which allows for updates for such software to be automatically downloaded and installed on your phone. By installing the software, you hereby agree and consent that Acer (or its licensors) may automatically check the version of such software that you are using on your phone and may provide upgrades to such software that may be automatically downloaded on to your phone.

OWNERSHIP AND COPYRIGHT

Title, ownership rights and intellectual property rights in and to the Software and all copies thereof shall remain with Acer or Acer's licensors or suppliers (as applicable). You do not have or shall not gain any proprietary interest in the Software (including any modifications or copies made by or for you) or any related intellectual property rights. Title and related rights in the content accessed through the Software is the property of the applicable content owner and may be protected by applicable law. This license gives you no rights to such contents. You hereby agree

1. Not to remove any copyright or other proprietary notices from the Software;
2. To reproduce all such notices on any authorized copies you make; and
3. To use best efforts to prevent any unauthorized copying of the Software.

TRADEMARKS

This Agreement does not grant to you any rights in connection with any trademarks or service marks of Acer or of Acer's licensors or suppliers.

DISCLAIMER OF WARRANTIES

TO THE MAXIMUM EXTENT PERMITTED BY APPLICABLE LAW, ACER, ITS SUPPLIERS, AND ITS LICENSORS, PROVIDE THE SOFTWARE "AS IS" AND WITH ALL FAULTS, AND HEREBY DISCLAIM ALL OTHER WARRANTIES AND CONDITIONS, EITHER EXPRESS, IMPLIED OR STATUTORY, INCLUDING, BUT NOT LIMITED TO, ANY IMPLIED WARRANTIES, DUTIES OR CONDITIONS OF MERCHANTABILITY, OF FITNESS FOR A PARTICULAR PURPOSE, OF ACCURACY OR COMPLETENESS OF RESPONSES, OF RESULTS, OF WORKMANLIKE EFFORT, OF LACK OF VIRUSES, AND OF LACK OF NEGLIGENCE, ALL WITH REGARD TO THE SOFTWARE AND THE PROVISION OF OR FAILURE TO PROVIDE SUPPORT SERVICES. ALSO, THERE IS NO

WARRANTY OR CONDITION OF TITLE, QUIET ENJOYMENT, QUIET POSSESSION, CORRESPONDENCE TO DESCRIPTION OR NON-INFRINGEMENT WITH REGARD TO THE SOFTWARE.

EXCLUSION OF INCIDENTAL, CONSEQUENTIAL AND CERTAIN OTHER DAMAGES

TO THE MAXIMUM EXTENT PERMITTED BY APPLICABLE LAW, IN NO EVENT SHALL ACER, ACER'S SUPPLIERS, OR ACER'S LICENSORS, BE LIABLE FOR ANY SPECIAL, INCIDENTAL, INDIRECT, PUNITIVE, OR CONSEQUENTIAL DAMAGES WHATSOEVER (INCLUDING, BUT NOT LIMITED TO, DAMAGES FOR LOSS OF PROFITS OR CONFIDENTIAL OR OTHER INFORMATION, FOR BUSINESS INTERRUPTION, FOR PERSONAL INJURY, FOR LOSS OF PRIVACY, FOR FAILURE TO MEET ANY DUTY INCLUDING OF GOOD FAITH OR OF REASONABLE CARE, FOR NEGLIGENCE, AND FOR ANY OTHER PECUNIARY OR OTHER LOSS WHATSOEVER) ARISING OUT OF OR IN ANY WAY RELATED TO THE USE OF OR INABILITY TO USE THE SOFTWARE, THE PROVISION OF OR FAILURE TO PROVIDE SUPPORT SERVICES, OR OTHERWISE UNDER OR IN CONNECTION WITH ANY PROVISION OF THIS AGREEMENT, EVEN IN THE EVENT OF THE FAULT, TORT (INCLUDING NEGLIGENCE), STRICT LIABILITY, BREACH OF CONTRACT OR BREACH OF WARRANTY OF ACER OR ITS SUPPLIERS OR LICENSORS, AND EVEN IF ACER AND ITS SUPPLIERS AND LICENSORS HAVE BEEN ADVISED OF THE POSSIBILITY OF SUCH DAMAGES.

LIMITATION OF LIABILITY AND REMEDIES

NOTWITHSTANDING ANY DAMAGES THAT YOU MIGHT INCUR FOR ANY REASON WHATSOEVER (INCLUDING, WITHOUT LIMITATION, ALL DAMAGES REFERENCED ABOVE AND ALL DIRECT OR GENERAL DAMAGES), THE ENTIRE LIABILITY OF ACER, ITS SUPPLIERS, AND ITS LICENSORS, UNDER ANY PROVISION OF THIS AGREEMENT, AND YOUR EXCLUSIVE REMEDY FOR ALL OF THE FOREGOING, SHALL BE LIMITED TO THE AGGREGATE AMOUNT PAID BY YOU FOR THE SOFTWARE. THE FOREGOING LIMITATIONS, EXCLUSIONS AND DISCLAIMERS (INCLUDING DISCLAIMER OF WARRANTIES AND EXCLUSION OF INCIDENTAL, CONSEQUENTIAL AND CERTAIN OTHER DAMAGES ABOVE) SHALL APPLY TO THE MAXIMUM EXTENT PERMITTED BY APPLICABLE LAW, EVEN IF ANY REMEDY FAILS ITS ESSENTIAL PURPOSE; PROVIDED, HOWEVER, THAT BECAUSE SOME JURISDICTIONS DO NOT ALLOW THE EXCLUSION OR LIMITATION OR LIABILITY FOR CONSEQUENTIAL OR INCIDENTAL DAMAGES, THE ABOVE LIMITATION MAY NOT APPLY TO YOU.

TERMINATION

Without prejudice to any other rights, Acer may immediately terminate this Agreement without notice if you fail to comply with any terms and conditions of this Agreement.

In such event, you must:

1. Cease all use of the Software;
2. Destroy or return to Acer the original and all copies of the Software; and
3. Delete the Software from all phones on which it was resident.

All disclaimers of warranties and limitation of liability set forth in this Agreement shall survive termination of this Agreement.

GENERAL

This Agreement represents the complete agreement between you and Acer relating to this license for the Software and supersedes all prior agreements, communications, proposals and representations between the parties and prevails over any conflicting or additional terms of any quote, order, acknowledgement or similar communication. This Agreement may only be modified by a written document signed by both parties. If any provision of this Agreement is held by a court of competent jurisdiction to be contrary to law that provision will be enforced to the maximum extent permissible and the remaining provisions of this Agreement will remain in full force and effect.

ADDITIONAL PROVISIONS APPLICABLE TO THIRD PARTY SOFTWARE AND SERVICES

Software provided hereunder by Acer's licensors or suppliers ("Third Party Software") is made available to you for your personal, non-commercial use only. You may not use the Third Party Software in any manner that could damage, disable, overburden, or impair the services provided by Acer's licensors or suppliers hereunder ("Third Party Services"). Furthermore, you may not use the Third Party Software in any manner that could interfere with any other party's use and enjoyment of the Third Party Services, or the services and products of Acer's licensors' or suppliers' third party licensors. Your use of the Third Party Software and Third Party Services is also subject to additional terms and conditions and policies which can be accessed through our global website.

Privacy policy

During registration you will be asked to submit some information to Acer. Please refer to Acer's privacy policy at www.acer.com or your local Acer website.

Getting to know your smartphone

Features and functions

Your new smartphone offers leading, easy-to-access multimedia and entertainment features. You can:

- Access your email while on the move.
- Connect to the Internet at high speed, via HSDPA (14.4 Mbps) or Wi-Fi.
- Keep in touch with your friends via your Contacts and social networking applications such as Acer SocialJogger.
- Listen to rich, full-impact audio via Dolby Mobile.
- Record 720p video.
- Playback 720p video with HDMI output to your TV.

Product registration

When using your product for the first time, it is recommended that you immediately register it. This will give you access to some useful benefits, such as:

- Faster service from our trained representatives.
- Membership in the Acer community: receive promotions and participate in customer surveys.
- The latest news from Acer.

Hurry and register, as other advantages await you!

How to register

To register your Acer product, please visit mobile.acer.com. Click **Product Registration** and follow the simple instructions.

You can also register directly from your smartphone by tapping the **Acer Registration** icon.

After we receive your product registration, you will be sent a confirmation email with important data that you should keep in a safe place.

Chapter 1: Setting Up

Unpacking your smartphone

Your new smartphone comes packed in a protective box. Carefully unpack the box and remove the contents. If any of the following items is missing or damaged, contact your dealer immediately:

- Acer ICONIA SMART
- Battery
- Quick Guide
- USB cable
- AC adapter
- Headset
- Screen protector

Getting to know your smartphone

Views

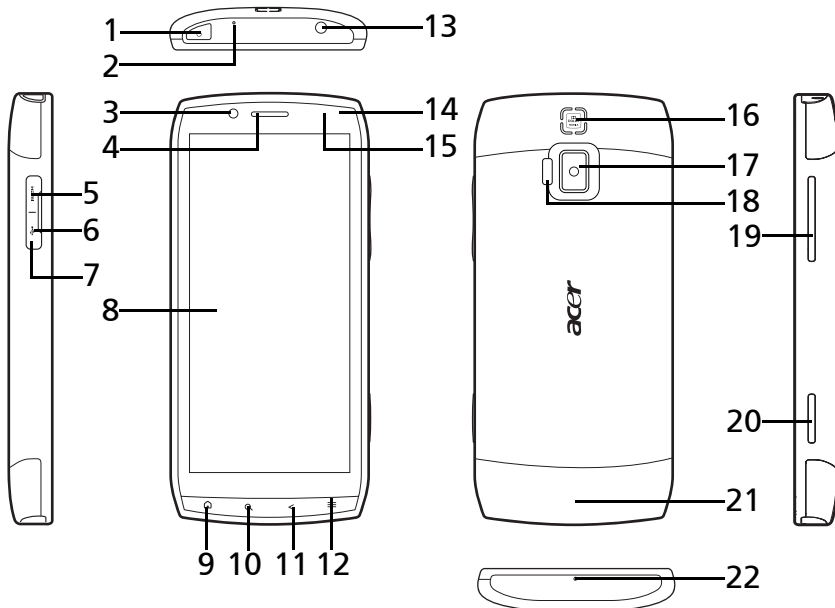

No.	Item	Description
1	Power button*	Press to turn the screen on/off or enter sleep mode; press and hold to turn the smartphone off.
2	2nd microphone	For active noise cancellation
3	Front-facing camera	2-megapixel front-facing camera for taking self-portrait pictures.

No.	Item	Description
4	Phone speaker	Emits audio from your smartphone; suitable for holding to your ear.
5	Micro HDMI port (Type D)	Connect to HDMI-compatible displays.
6	Micro USB port	Connect to a USB cable/charger.
7	HDMI / USB cover**	Open this cover to find the HDMI and USB ports.
8	Touchscreen	4.8-inch, 1024 x 480 pixel capacitive touchscreen to display data, phone content and enter information.
9	Home button*	Return to the Home screen; press and hold to view recently-used applications, tap an icon to open the associated program.
10	Search button*	Open the Google search function.
11	Back button*	Go back one menu step; close the onscreen keyboard.
12	Menu button*	Open the option menu; press and hold to display the keyboard.
13	3.5 mm headset jack	Connect to stereo headset.
14	LED indicator	Indicates battery level and event status.
15	Proximity and light sensor	Determines the ambient brightness, detects the presence of an object nearby and whether the object is moving closer or further away.
16	Handsfree speaker	Emits audio from your smartphone; suitable for handsfree use.
17	Rear camera	An 8-megapixel camera for taking high-resolution images.
18	Flash	Built-in camera flash.
19	Volume up / down button	Increase or decrease the phone volume.
20	Camera button*	Activate the camera or take a picture.
21	Battery cover	Open this cover to insert or remove the battery, and to install a SIM or microSD card.
22	Microphone	Internal microphone.

* Press any button to wake your smartphone from sleep mode.

** Avoid twisting the cover as it may become damaged. Avoid touching the edges around the ports as they may be sharp.

LED indicators

LED color	State	Description
Off		No incoming or missed calls.
Red	Flashing	Battery is critically low and needs to be charged.
White	Flashing	Missed call, voicemail, or new message.
Orange	Steady	Device is plugged in: Battery is charging.
Green	Steady	Device is plugged in: Battery is fully charged.

Installing a SIM and optional microSD Card

To take full advantage of your smartphone's telephony capabilities, you must install a SIM card. The SIM card holder is located at the bottom of the battery bay.

Additionally, you may wish to increase your smartphone's storage by inserting a microSD Card (optional) into the slot provided. This is next to the SIM card slot.

1. Turn off the phone by pressing and holding the power button.
2. Open the cover and remove the battery.
3. Insert the SIM and microSD Card as shown.
4. Replace the battery and battery cover.

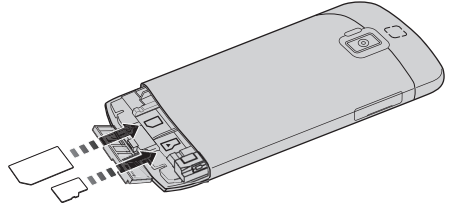

.....
Note: You need to insert the SIM and microSD Card before inserting the battery.
.....



.....
Note: Ensure that the microSD Card is inserted all the way into the card slot.
.....



.....
Caution: Turn off your smartphone and remove the battery before installing or removing the SIM or microSD card. You may damage the card or your smartphone if the battery is still installed.
.....

SIM card lock

Your smartphone may come with a SIM card lock, i.e., you will only be able to use the SIM card provided by your network operator.

To cancel the SIM lock, contact your network provider.

Installing or removing the battery

Your smartphone uses a replaceable battery to provide power. It is packed separately from your smartphone and needs to be inserted and charged before you can use the smartphone.

Installing the battery

Remove the battery cover. Lay the smartphone. Unclip the battery lock.

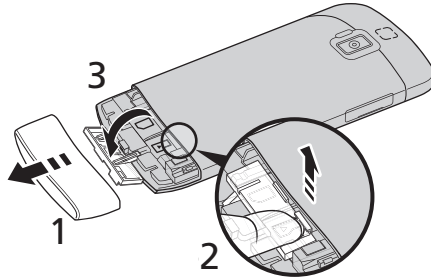

Place the battery into the battery compartment, lining up the battery connectors with those at the right side of the compartment.

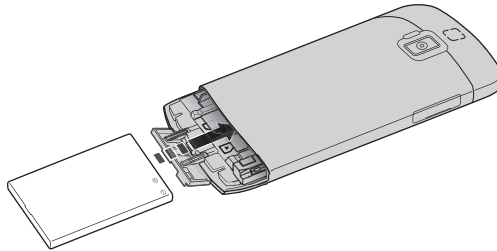

Lock the battery in place.

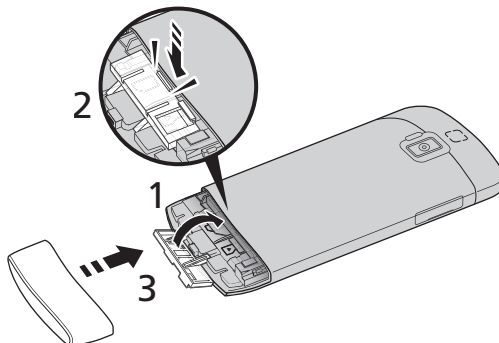

**CAUTION: RISK OF EXPLOSION IF BATTERY IS REPLACED BY AN INCORRECT TYPE.
DISPOSE OF USED BATTERIES ACCORDING TO THE INSTRUCTIONS.**

Charging the battery

For initial use, you need to charge your smartphone for eight hours. After that you can recharge the battery as needed.

Connect the AC adapter cord to the micro USB connector on your smartphone.

You can also charge your smartphone from a USB port on your PC. Please refer to **"Acer USB Fast Charge"** on page 46 for further details.

Removing the battery

Remove the battery cover. Unlock the battery and pull the release latch.

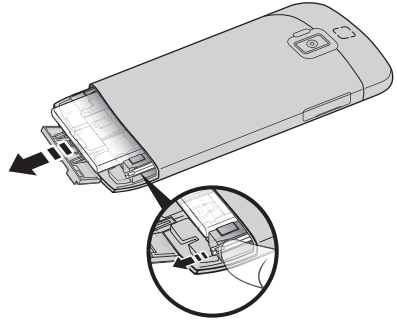

Chapter 2: Using your Smartphone

Turning on for the first time

To turn on your smartphone for the first time, press and hold the power button until the screen turns on. You will then be asked to configure some settings before you can use your smartphone.

Follow the onscreen instructions to complete setup.

Sign in to or create a Google account

If you have Internet access, your smartphone allows you to synchronize information with a Google account.

During the start-up process, you may create or sign in to your account, which will be used to synchronize your contact list, email, calendar and other information. If you do not yet have Internet access, or do not want to use this feature, then tap Skip.

Creating multiple Google accounts

You can create and easily access multiple Google accounts. Tap **Settings > Accounts & sync > Add account**.

Entering your PIN

When you install a SIM card for the first time, you may need to enter a PIN using the onscreen number pad.



.....
Important: Depending on your settings, you may be required to enter your PIN each time you switch on the phone function.
.....

Activating a new SIM card

If you are using your SIM card for the first time, it may require activation. Contact your network operator for details on how to do this.

Locking your smartphone

If you will not use your smartphone for a while, briefly press the power button to lock access. This saves power and ensures your smartphone does not unintentionally use any services. Your smartphone will lock automatically if it is not used for one minute.

Waking your smartphone

If the screen is off and the smartphone does not react to any taps on the screen or front panel button, then it has been locked and is in sleep mode.

Press the power button, or any of the home / search / back / menu buttons to wake your smartphone. Your smartphone will display the widgets screen. Unlock your smartphone by dragging the peel up or to the right.

For additional security, you may set an unlock pattern, a set of dots that must be tapped in the correct order to access the phone. Tap **Settings > Location & security > Set up screen lock**.

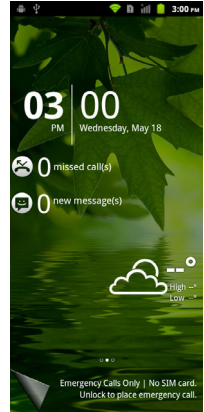

Note: If you forget your unlock pattern, please refer to “Unlock pattern” on page 54.

Using the touchscreen

Your smartphone uses a touchscreen for selecting items and entering information. Use your finger to tap the screen.

Tap: Touch the screen once to open items and select options.

Drag: Hold your finger on the screen and drag across the screen to select text and images.

Tap and hold: Tap and hold an item to see a list of actions available for that item. On the pop-up menu that appears, tap the action you want to perform.

Scroll: To scroll up or down the screen, simply drag your finger up or down the screen in the direction that you want to scroll.

Android keyboard

This is a standard onscreen QWERTY keyboard that allows you to enter text. Tap and hold a key with numbers at the top to select alternative characters, such as letters with accents.

Tap the **?123** button to see numbers and special characters, and then tap the **ALT** key to see even more.

To select your preferred languages, tap **Menu > Settings > Language & keyboard > Android keyboard > Input languages**. If you select multiple input languages, swipe across the space bar to change the keyboard layout.

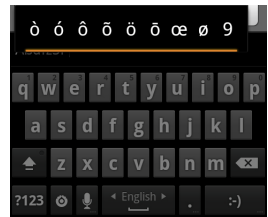

Text assistance

The Android keyboard has various features that assist you to enter correct text. Tap **Menu > Settings > Language & keyboard > Android keyboard**. From here you can enable or disable the following:

Function	Description
Quick fixes	Corrects commonly typed mistakes.
Show suggestions	Shows suggested words while you are typing.
Auto-complete	Inserts the suggested word whenever you tap space or a punctuation mark.

Changing the text input method

To change the input method, tap and hold a text box. Tap **Input method**, and then select your preferred input method.

Predictive text

Both XT9 Text Input and Android keyboard provide predictive text input. As you tap the letters of a word, a selection of words are displayed above the keyboard that continue the sequence of letters tapped, or are a close match allowing for errors. The word list changes after every key press. If the word you need is displayed, you can tap on it to insert it into your text.

XT9 Text Input

Tap the **?123** button to see numbers and special characters, and then tap the **ALT key** to see even more.

Additional keys vary depending on the type of text you enter, e.g. a key to add a smiley is available when typing a text message. Like other keys, tap and hold for additional options.



Text assistance

The standard XT9 keyboard has various features that assist you to enter correct text. Tap **Settings > Language & keyboard > XT9 Text Input**. From here you can enable or disable the following:

Function	Description
Languages and settings	Set the languages that will be available. Select the keyboard layout you prefer. There are three layouts available: <ul style="list-style-type: none">• Keyboard: A full QWERTY keyboard.• Reduced keyboard: Two letters are available on each key. Tap and hold the key to select a letter, including special characters.• Phone keypad: Three letters are available on each key. Tap and hold the key to select a letter, including special characters.
Preferences	Change your text input preferences.

The Idle screen

When you start your smartphone, or wake it from power saving, it will display the Idle screen. This screen protects your smartphone from accidental access and gives you quick access to information and simple controls with **widgets**. These display information such as the time or weather, or provide additional controls. Some have been pre-installed on your smartphone, while others may be downloaded from the Android Market.

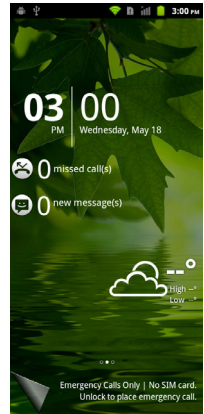

Adding or removing widgets

To add widgets, tap the menu button or open the applications menu and tap **Home Decor**, then select **Idle Screen**. Tap and hold on the screen to open a list of available widgets.

To reposition a widget, tap and hold the widget. You may then drag the widget to any point on the grid.

A red background indicates that the widget may not be placed in the chosen position, usually because widgets may not overlap. A green background indicates the position can be used.

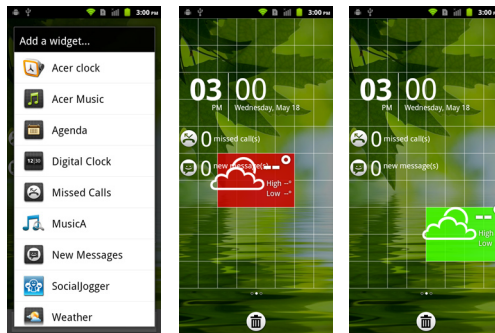

Drag the widget to the left or right edge of the screen to add it to either extended screen. Drag it to the trash icon to remove it from the screen.

Recent apps

To access recently opened apps while working on another process, press and hold the home button.

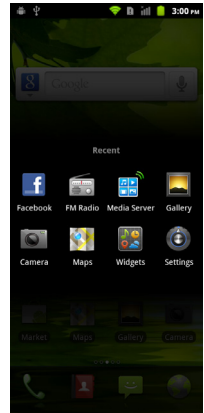

The Home screen

After rebooting, your smartphone will display the home screen. This screen gives you quick, icon-based access to many of the frequently used features of your smartphone.

At the bottom of the screen is the **application dock** which displays default applications. Tap an icon to open the application. Drag the application dock towards the top of the screen to see the applications menu. To change applications, see **"Changing application dock icons"** on page 22.

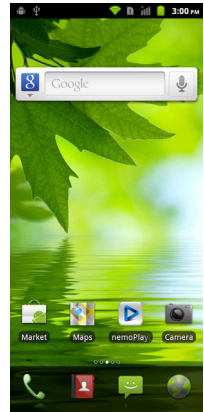

The extended Home screen

The Home screen extends to either side of the screen, giving you more room to add icons, widgets or features. To view the extended screen, slide your finger to the left or right.

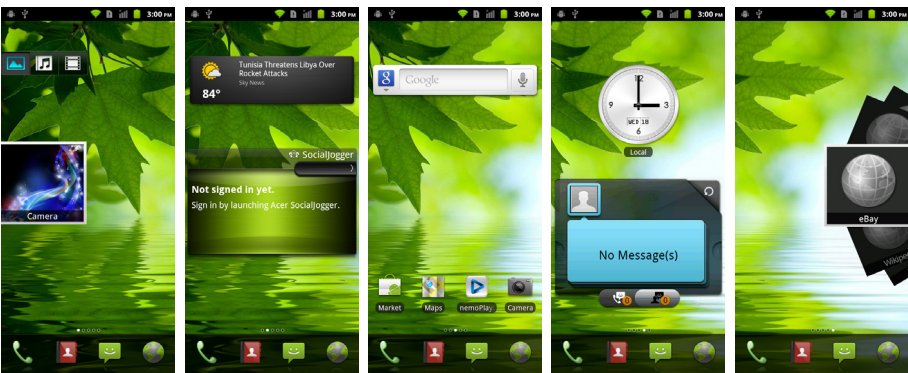

Adding or removing icons

You can set icons for installed applications on the Home screen. Tap and hold an icon in the Applications menu to copy it to the Home screen. To remove an icon from the Home screen, tap and drag the icon from the Home screen to the X mark that appears at the bottom of the screen.

Adding or removing shortcuts or widgets

To add shortcuts or widgets, press the menu button while in the Home screen, and tap **Add**, or tap and hold anywhere on the Home screen to open the **Add to Home screen** menu.

Tap **Shortcuts** to open a list of quick links to applications and settings you can add to the Home screen.

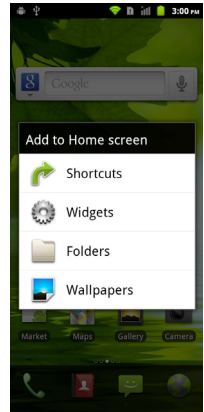

Tap **Widgets** to open a list of small applications that you can add to your Home screen. Widgets are handy applications that you can add to your Home screen to display various information.

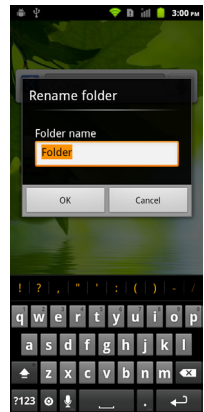

You can also add folders to your Home screen. There are some pre-defined folders available or you can add a **New folder**. This will be placed on your Home screen and named Folder. To change the name of the folder, tap to open it. Tap and hold the name bar at the top of the folder window to open a dialog box that will allow you to rename the folder.

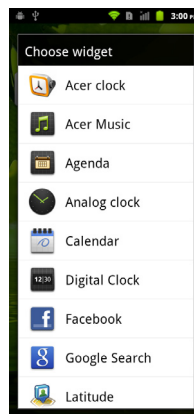

Tap **Wallpapers** to change the current wallpaper. You can choose from images stored in the Gallery, or Live wallpapers featuring animated or interactive backgrounds, or standard wallpapers.

Home Decor

You can change the wallpaper, configure sound alerts, and personalize your Idle screen by tapping **Home Decor** from the applications menu. Or press the menu button while in the Home screen, and tap **Home Decor**.

Select a wallpaper from the first row, or open your own pictures from the second row. Tap the image you wish to use as your smartphone's wallpaper. If you choose an image that is not the correct size, you will be asked to crop the image to the correct size. Tap and drag the box until you have selected the part of the image you want.

To set the wallpaper from the camera, follow the instructions on **"Taking a photo" on page 39**. In the picture review screen, tap the  icon and set picture as **Wallpaper**.

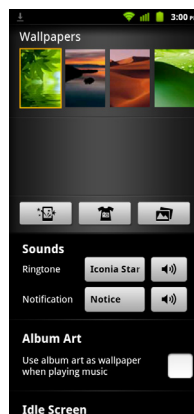

Multitasking

You can have multiple applications open at the same time. To open a new application, press the **Home** button to return to the Home screen, then start the new application.

To view your active applications, press and hold the **Home** button. Then tap an icon to go to the application.



.....
Tip: To prolong battery life, it is better to close an application when you've finished using it. Do this by either pressing the **Back** key or the menu button and selecting **Exit** (if available).
.....

The applications menu

The applications menu displays groups of applications in a series of pages.

The number of pages is displayed at the bottom of the screen. Drag the menu to the left or right to switch pages.

Tap and hold an icon to move or delete it; you may change the order of icons or reorganize the pages to suit your needs. Drag an icon to the edge of the screen, or one of the page numbers, to change the page.

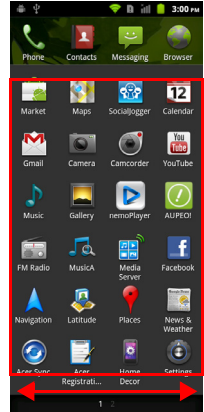

Notification area

The Notification area is at the top of the screen.







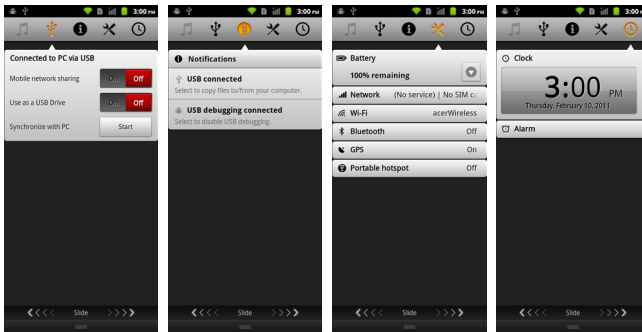









































This area contains a variety of icons to inform you of your phone's status. The left side of the Notification area displays event icons that indicate a new event (such as a new message). The icons on the right side indicate signal strength, connection, battery status and the time.

Drag the **Notification area** down the screen, or tap the area, to view more information about new events. You can also use the slide bar to switch between pages.



Icon	Description	Icon	Description
	Connected to GPRS mobile network		Roaming
	GPRS in use		No signal
	Connected to EDGE mobile network		SIM card is invalid or not installed
	EDGE in use		Vibrate mode

Icon	Description	Icon	Description
	Connected to 3G mobile network		Ringer is silenced
	3G in use		Phone microphone is off
	Cellular signal strength		Battery is very low
	Connected to a wireless network		Battery is low
	Bluetooth is on		Battery is partially drained
	Connected to a Bluetooth device		Battery is full
	Airplane mode (wireless connectivity disabled)*		Battery is charging
	Alarm is set		GPS is on
	Speakerphone is on		Receiving location data from GPS
	New Gmail message		More notifications
	New/unread SMS/MMS		Call in progress
	Problem with sending SMS/MMS		Call in progress using Bluetooth
	New Google Talk message		Missed call
	New voicemail		Call on hold
	Upcoming event		Call forwarding is activated
	Syncing data		Song is playing
	Problem with sign-in, sync or installation		Uploading data
	SD card or USB storage is full		Downloading data (animated)
	An open wireless network is available		Download finished
	Phone is connected to PC via USB		Application update available
	Connected to or disconnected from virtual private network (VPN)		Application update or install finished
	USB tethering is activated		System update available
	Wireless tethering is activated		Carrier data use threshold exceeded
	USB and wireless tethering are activated		

* Please disable airplane mode before trying to make a call.

Changing application dock icons

You can set icons for installed applications in the application dock. Open the applications menu and find the application you want to add. Tap and hold the icon, then drag it to a position in the dock, it will be added in place of the existing application.

To remove an icon from the dock, open the applications menu, then tap and hold an icon to select it. Either drag the icon to a different page in the applications menu, or to the trash icon that appears at the bottom left corner of the screen.

Chapter 3: Managing contacts





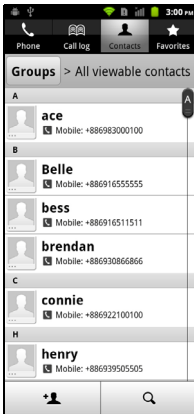

Managing your contacts

Your smartphone features an address book that allows you to save contacts to either the internal memory or onto your SIM card.

Tap **Contacts** from the Home screen or the **Contacts** tab from the Dialer to view your contacts.

If you don't have any contacts stored on your phone, you can import your Google account contacts, add a new contact or import contacts from your SIM or SD card. Press the **Menu** button to open the menu.



Icon	Description
	Add a new contact.
	Add your personal details.
	Open contact lists from different accounts.
	Search for a contact.
	Send contact card via Email, MMS or Bluetooth.
	More options, such as: sorting, managing groups, display options, import/export and deleting contacts.

Adding a contact

Tap **New contact** to add a new contact. You may also scan a person's profile barcode to add the person to your contact list or group.

You will be asked if you want to create a SIM, Phone, or Google contact.

To create a contact, you will be asked to enter the contact's:

- Given and Family name.
- Phone numbers.
- Email addresses.
- IM addresses.
- Postal addresses.

You may also:

- Enter information such as organizations the contact belongs to.
- Add any personal notes about the contact.

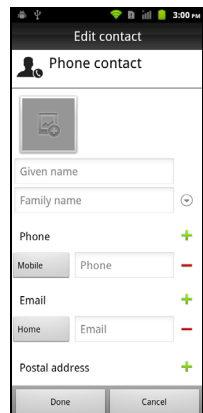

- Enter a nickname.
- Link a website.
- Add an Internet call account
- Assign the contact to a group
- Assign a ringtone
- Divert calls from the contact to voicemail

To assign an image to your contact, tap the silhouette and select whether to take a photo or select an image from your smartphone's picture gallery.





.....
Tip: You may also create a contact from an already dialed or received number, see
"Saving a dialed number to contacts" on page 28.
.....

Chapter 4: Making Calls

This chapter shows you how to make phone calls, and the various options available to you during your call.

Before making a call

Check that the phone function is on before you make a call. You can confirm the phone status from the icon on the right-hand side of the Notification area.

Icon	Description
	Connected: You may make a call.
	Airplane mode: Wireless connectivity disconnected. Please disable airplane mode before trying to make a call.

Making a call



Note: The phone function needs to be enabled before the call can be connected.

1. From the Home screen tap **Dialer** or open **Dialer** from the menu.
2. Enter the number you wish to dial.
3. Tap  to make the call.
4. To end the call, tap **End Call**.

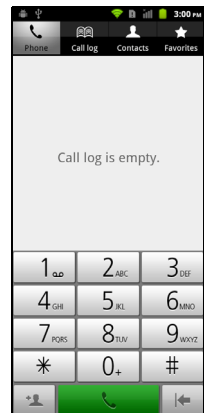

Smart search

Smart search allows you to quickly find a contact from the phone keypad. As you enter a number, if it is already known, it will find appropriate contacts and display them in the list above the keypad. Also, instead of typing a phone number, you may enter the contact name using the predictive text letters (2 for 'a', 'b' or 'c'; 3 or 'd', 'e' or 'f'; etc.). If the letter combinations match a contact name, it will be displayed.

If the contact you need is displayed, simply tap the contact name to make a call.

Viewing missed calls

Missed calls will be displayed by the call indicator in the Notification area with the  icon.

1. Open the notification list by tapping the Notification area to display the details of the missed calls.
2. Select the call from the list and tap **Return call** to return the missed call. You can save phone numbers to your contacts list from the Call Log. Please refer to **"Adding a contact"** on page 23 for further details.

Dialing a number from the call log

Tap the Dialer to view your call history. It displays recent received, dialed, and missed calls.

Tap the number to redial. You may also tap and hold the number to open a menu with other options: **Call <the number>**; **View contact**; **Edit number before call**; **Send text message**; **Add to contacts** or **Remove from call log**.

Making a call to one of your contacts

1. Tap the **Contacts** tab in the dialer or **Contacts** from the Home screen to view your contacts.
2. Tap a contact. A dialog will open, asking if you want to Call the contact or send the contact an SMS.

Dialing an international number

When dialing international numbers, there is no need to enter the international direct dialing prefix ('00' etc.) before the country code. Simply tap and hold **0+** on the onscreen number pad until **+** appears onscreen.



.....
Warning: International call rates can vary greatly depending on the country you are calling and your network provider. We suggest you check all call rates with your network provider, to avoid excessive phone bills. If you are using your smartphone abroad, roaming charges will apply. Consult your network provider for roaming rates specific to the country you are visiting before you leave.
.....

Speed Dial

You may add a contact to a Speed Dial number on the phone keypad. Open the **Phone** tab, then tap and hold any number from 2 through 9 (1 is reserved for the voicemail service).

Select **OK**, then select a contact from the list. If the contact has more than one phone number, select the number to use.

If a key has a speed dial contact defined, it will show a small contact image as a reminder. Tap and hold the key to call the speed dial number.

If you want to remove or change a speed dial number, tap **Menu** and select **Speed dial**. Tap an entry to remove or change the assigned telephone number.

The voice call screen

Once you have dialed your number the voice call screen appears, which displays the number/contact you are talking to, the call duration and the dialpad tab.

Answering or declining a call

When you have an incoming call, the number will be shown on the screen. To accept or decline the call, tap the appropriate button.

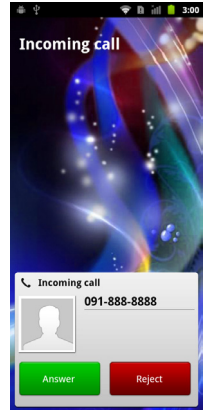

If you are answering a call from a locked state, slide the bar to answer the call. To reject a call from a locked state, press the power button.

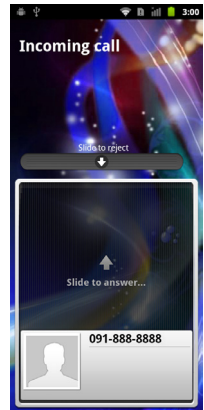

Ending a call

To end a call, press **End Call** from the voice call screen.

Voice call options

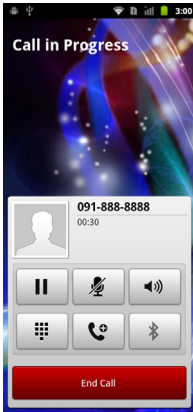

Icon	Description
	Place the call on hold.
	Mute a call.
	Speakerphone.
	Access the keypad while a call is in progress.
	Add a second call.
	Bluetooth headset.

Saving a dialed number to contacts

You can save a number you have dialed to your contacts for future use.

1. Select the number from the **Call log** tab, and tap **Add to contacts**.
2. Tap **Create new contact** and select how to complete the action. Please refer to **"Adding a contact"** on page 23.

Conference calls

If you have one call on hold and another on line, you can combine both calls to create a conference call.

After the first call is established, tap to add a second call. Tap to start the conference call.

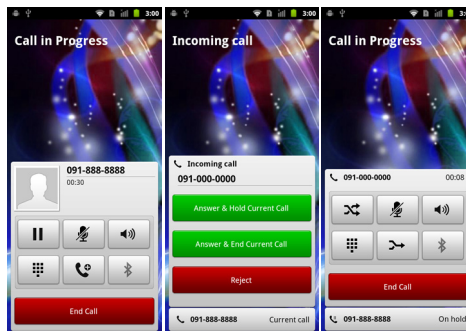

Chapter 5: Internet Calling

You can place and receive Internet calls over wireless network.

Adding an Internet calling account

Tap **Settings** > **Call settings** > **Accounts**. Tap **Add account**, and input the **Username**, **Password**, and **Server** accounts. You can also configure optional settings such as Display name, Outbound proxy address, Port number, Transport type, and Send keep-alive.

Editing or removing an Internet calling account

Open an existing Internet calling account and make the edits you want on the SIP account details. Press the Menu button and tap **Save** to save your changes, or **Discard**. Or tap **Remove account** to delete the existing account.

Using Internet calling

You can configure your phone to use Internet calling (when you're connected to Wi-Fi) for all calls, only for Internet calls, or to ask each time you place a call.

Receiving Internet calls

You can configure your phone to receive Internet calls made to an Internet calling account you added to your phone. To receive Internet calls, tap **Settings** > **Call settings** > **Accounts**. Make sure the **Receive incoming calls** box is checked.

Calling a contact's Internet calling address

You must add an Internet calling address to a contact to be able to place an Internet call to them.

To make an Internet call, open your contact list and tap the contact icon, then tap the SIP icon .

Calling a phone number using Internet calling

If you have configured your phone to place all calls using Internet calling or to ask for each call, you may also call a phone number using Internet call, whenever you are connected to a wireless network.

Dial the number and tap , or select the contact you wish to place a call to, then tap the Internet call account you want to use to make the call.



.....
Important: Calling a phone number using Internet calling requires that your service provider supports it, and may incur additional charges. Please contact your service provider if you have any questions.
.....

Chapter 6: Messaging

This chapter shows you how to set up and use the **Phone messages**, **Social messages** and **Social events** functions of your smartphone.

All SMS and MMS messages are accessed via **Messaging**. Messaging automatically arranges received and sent messages into threads.

To access Messaging tap **Messaging** on the Home screen.

Creating a new message

You can use your phone to compose Phone (SMS and MMS) messages.

Tap  to compose a new message.





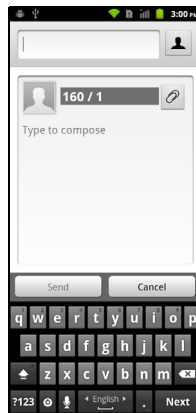

Enter the recipient's phone number or name in the **To** field. Suggested contacts will be displayed in a drop-down list below the text field. To select a suggested contact, tap the contact's name.

Once you have entered the recipient, enter your message in the text box labeled **Type to compose**.



Note: SMS messages may be up to 160 characters long. If your message is longer than 160 characters, it will be sent as multiple linked messages. Most phones will automatically join the linked messages to present the recipient with a single long message, however, some older phones do not have this ability.

Press the Menu button to see what options are available when creating a new message. The options change depending on the status of the message.

Icon	Description
	Insert one or more recipients from your contacts.
	Convert the SMS to an MMS, allowing you to add a subject to the message.
	Convert the SMS to an MMS, allowing you to attach a file to the message.
	Insert a smiley/emoticon into your message text.
	Discard the message. This option is available if no recipient is added to the To box. This is replaced by a Send button if a recipient is added.
	See more options, such as: All Threads (see a list of messages) and Add Text (add information from your agenda or contacts).

Replying to a message

When a new text message arrives a message icon appears in the Notification area and the message icon on the top of the phone lights up.

Tap **Messaging** on the Home screen to view the message list or expand the Notification area to see a summary of the message. Tap the summary to open the message list.

To reply to an SMS or MMS message, open the message from the message list. Enter your text in the text box labeled **Type to compose**. Press the Menu button to see available options, such as calling the sender or adding them to your contact list.

MMS messages

MMS messages are similar to text messages but also allow you to attach multimedia files such as pictures, audio or video clips. Each MMS message can be up to 300 kB in size.



.....
Note: You need to set up an MMS profile before you can send MMS messages. Normally, your smartphone will set up the profile for you based on information retrieved from your provider.
.....



.....
Tip: Ask your network provider for the necessary information if you need to manually set up the MMS profile.
.....

Receiving MMS messages

When a new MMS message arrives, a message icon appears at the top of the screen and a notification message is displayed.

1. Open Messaging to view a summary of the message.
2. Tap **Download** to download the message content.



.....
Note: Downloads can take a long time, depending on your connection quality. If you reply or open another application, the download will be stopped.
.....



.....
Important: You may be charged to download message content, especially if you are roaming. Please contact your provider if you have any questions.
.....

3. Tap the message to view the content.
4. To reply to the message, enter your text in the text box labeled **Type to compose** and tap **Send**. Simple text replies will be sent as SMS messages. If you wish to attach a file, press the Menu button and tap **Attach**. You will be presented with a menu of options.
5. When you have finished composing the message, press the Menu button and tap **Send**.

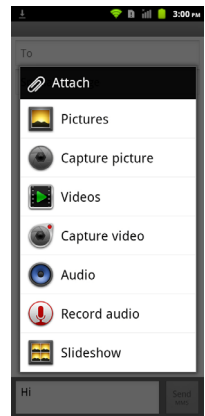

Social messages

You can send social messages to your contacts in Facebook using the Social messages function in Acer SocialJogger. See “Acer SocialJogger” on page 36.

Open Acer SocialJogger, tap the menu button and tap **Social messages**. Tap  to compose a new message.

Chapter 7: Going online

Browsing the Internet

In order to browse the Internet with your smartphone, you must be connected to a data or wireless network.

Using the browser

Tap **Browser** on the Home screen to start browsing. To open a new website, tap the address box at the top of the page. Enter the address using the keyboard and tap **Go**.

To view your browsing history, bookmarks or frequently visited sites, open the browser then press and hold the back button.

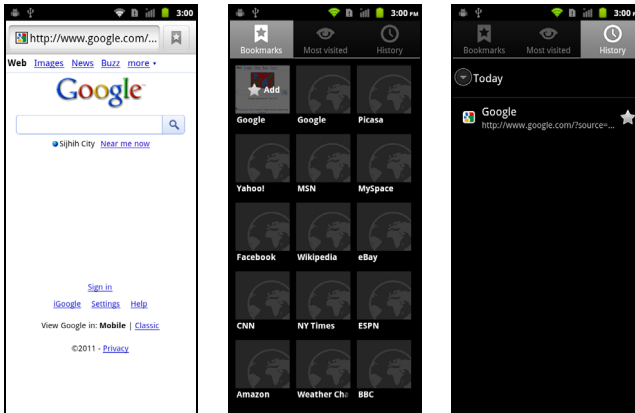

You may open multiple pages. When a page is open, press the Menu button and tap **New window** from the menu that opens. Tap **Windows** to view all the windows that are open.

You can zoom in or out of pages using the zoom bar that appears when you tap the screen. Tap and hold an item on a page to open a contextual menu.



Tip: Some websites automatically provide pages optimized for viewing on mobile devices. These sites may allow you to switch to the desktop version; look for a 'desktop version' link on the main page.

Adobe Flash support

Your smartphone supports Adobe Flash content, as used on many websites. Visit the Android Market to download Adobe Flash Player.

Voice Search



Note: Voice search is available only in some regions.

With voice actions, you can send text messages, place calls, send emails, find directions of establishments, automatically call establishments, search the Internet and even send a note to yourself using your voice. Open Voice Search from the Applications menu, or press and hold the Search button. Press and hold the Search button again to display the “Speak now” prompt, and state your command.

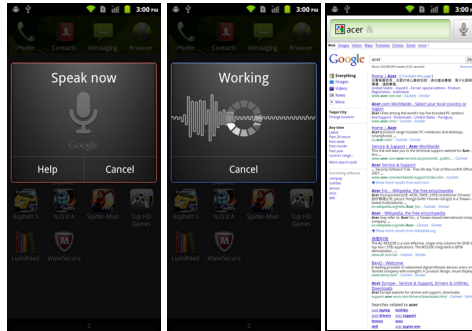

Setting up Gmail

1. Make sure your smartphone is connected to a data or Wi-Fi connection.
2. From the Applications menu tap **Gmail**.

If you did not enter your Gmail account address and password when you first started your phone, follow the on screen instructions.

Composing an email

1. Make sure your smartphone is connected to a data or Wi-Fi connection.
2. From the Home screen tap **Gmail**.
3. Press the **Menu** button and then tap **Compose**.
4. Enter the recipient's email address, the subject and message.
5. When you are finished composing your message, tap **Send**.

Setting up Email

Your smartphone enables you to access your email. Most popular ISPs can be set up in two steps. Tap **Email** to start setting up your email account.

If necessary, enter your email address and tap **Manual setup** to enter the parameters manually. Tap **Next** to finish the setup process.

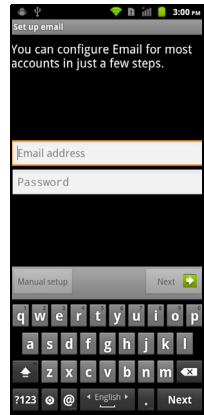

Android market



Note: The Android Market may not be available in all countries and regions.



Note: You need to have a Google account set up and active on your phone before you can use the Android Market.

Tap **Market** from the Applications menu to open the Android Market. Here you can obtain a variety of add-on programs and applications to enhance the functionality of your smartphone. The first time you access the Android Market, you will need to read and accept the Terms of Service.

You can browse the market by category or tap the search icon to search for a specific application.

Once you have selected an application, tap the **Install** button to download and install the application. You will be told which services on your phone that the application has access to. Tap **OK** to proceed with the installation.

You may keep track of the download progress from the Notification Area.

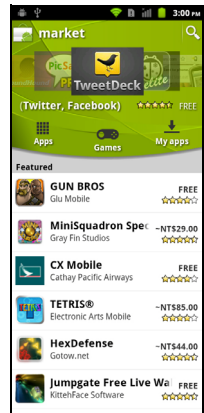

Important: Some applications may require payment before you can download them. You will need to have a Google Checkout account in order to pay for these applications.

Uninstalling downloaded applications

Once you've downloaded and installed an application, you may uninstall the application by tapping **Settings** from the Applications menu. Select **Applications > Manage applications**. Tap the application you wish to uninstall, tap **Uninstall** and confirm the uninstall.

Acer SocialJogger

Acer SocialJogger combines your social network updates in one location, allowing you to quickly follow what your friends are doing across several platforms.

From the applications menu, tap Acer SocialJogger to launch the program.

Select **Sign in** to enter your account information. When you are finished press **Start**.

Cycle through the notification updates using the slider on the right.

Tap on a notification to view more details and make a comment.

You can tap the icons on the top to view All, My Page, Link, Photos, and Notifications, or drag the page to the left or right to switch pages.

Tap the **Menu** button to refresh the page, access account settings, add pages, auto play, view your friends list and photo albums.

Widgets

Two Acer SocialJogger widgets are available, Message and SocialJogger. Both are available on your smartphone's extended Home screens.

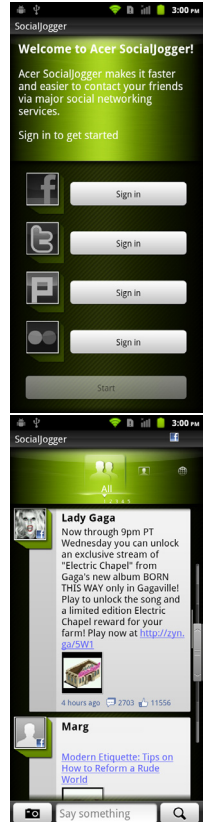

Social messages

You can send social messages to your contacts in Facebook using the Social messages function. Tap the menu button and tap **Social messages**. Tap  to compose a new message.

Social events

Tap the **Social events** icon on top to view social event invitations and respond through your smartphone.

Events accepted with **Social events** will be added to your Google Calendar.

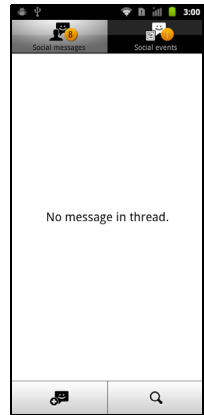

Maps, Navigation, Places and Latitude

Get easy-to-follow directions using Google Maps, view real-time traffic condition and navigate by using spoken, turn-by-turn driving instructions with Navigation, view where your friends are and places of interest and local businesses on Google Maps using Places and Latitude.



.....
Important: Maps does not have information about every location.
.....

Using the map

Tap the Maps icon in the applications menu. Drag the map with your finger to move the map around.

To zoom in or out:

1. Tap the plus or minus signs on the lower right corner, or
2. Double tap a location on the map to zoom in on the location, and tap once to zoom out, or
3. Touch an area with two fingers at once and spread them apart to zoom in, and pinch them together to zoom out.



.....
Important: Not all zoom levels are available for all locations.
.....

Chapter 8: Using the Camera

Your smartphone features an 8-megapixel digital camera mounted on the rear, with a 2-megapixel front-facing camera function. This section will take you through all the steps in taking photos and videos with your smartphone.

To activate the camera, long press the camera button or open the Applications menu and tap **Camera**.







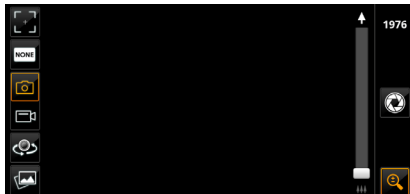







Note: You can also activate the camera while the smartphone is in sleep mode by pressing the camera button.

Camera icons and indicators



In the camera window, the icons on the left screen allow you to set the focus, switch between camera and camcorder, switch between the first camera and front-facing camera, and view the gallery of pictures or videos.















Tap  to display the zoom slider. Tap  to take a picture.

Icon	Description
	Adjusts the focus — normal, facial recognition  , and macro  . * Only for the rear camera.
	Select capture mode: <ul style="list-style-type: none"> — Standard point and shoot mode. — Detects a smile and automatically takes a picture. — Panoramic mode. See “Taking a panoramic photo” on page 40.
	Activates the camera.
	Activates the camcorder.
	Switch between the front-facing and rear camera.
	Takes you to the gallery.

The number in the top right corner shows how many more photos can be stored, or the maximum duration for a video.

Camera settings menu

To adjust the settings, tap **Menu**. The menu options are:

Icon	Description
	Set the photo quality.
	Turn the flash on or off, auto, and anti red eye. * Only for the rear camera.
	Set brightness.
	Set contrast.
	Set saturation.
	Set sharpness.
	Set the white balance — Auto, Daylight, Cloudy, Fluorescent, Incandescent.
	Set the timer — Off, 2 seconds, 10 seconds.
	Select photo storage location — SD card or internal memory.
	Set the scene mode — Normal, Backlight, Snow, Night, Sunset, Beach, Softskin, Forest. * Only for the rear camera.
	Set the effects — None, Mono, Negative, Sepia, Aqua.
	Set store location on (enables geotagging) or off. Please refer to “Geotagging” on page 41 .
	Set anti-banding.
	Set other settings: Anti-shake, ISO, Auto exposure, AE lock, Time stamp, Review duration, JPEG quality
	Restore all settings back to default.

Taking a photo

1. Ensure you have adjusted the parameters described above.
2. Frame your subject and steady your smartphone.
3. Zoom in or out as needed.
4. Tap  or press the camera button to take a picture.

Taking a panoramic photo

Panoramic mode allows you to take a series of five photos that the camera application will 'stitch' together to make a single extended image.

1. To take a panoramic photo, select panoramic capture mode .
2. Align the camera to take a photo of one end of the panoramic scene (the furthest left, right, top or bottom).
3. Press the camera button to take the first image; then smoothly move and rotate the camera to take the next image of the scene.
 - A red selection area shows the center of the next image; move the camera so the selected area is in the center of the screen; your smartphone will then automatically capture the image and select the center of the next image. Repeat to capture all images.



Note: If fewer than five images are sufficient for your panoramic photo, press the **Back** button to stop the selection process and process the captured images.

The camera application will process the images and save a single extended image to your smartphone's gallery.











Note: Panoramic images work best with static outdoor scenes. Objects too close to the camera or large straight edges may confuse the detection process.

Camcorder settings menu

Tap  to activate the camcorder. Tap  to mute, and tap again to unmute.

To adjust the settings, tap **Menu**. The menu options are:

Icon	Description
	Set the video quality.
	Turn the flash on or off, auto, and anti red eye. * Only for the rear camcorder.
	Set the white balance — Auto, Daylight, Cloudy, Fluorescent, Incandescent.
	Select video storage location — SD card or internal memory.
	Set anti-banding.
	Set video format.
	Set the length of the video recording.

Icon	Description
	Restore all settings back to default.

Shooting a video

1. Frame your subject and steady your smartphone and zoom in or out as needed.
2. Tap  to start recording. Tap or press again to stop recording.

Supported formats

Type	Formats
Image	JPEG, GIF, PNG, BMP
Video	MPEG-4, H.263, H.264

Viewing photos and videos

After you have taken your photo or video, it is automatically saved.

Once you have taken a photo or video, you can view it in Gallery by tapping  in the lower left corner. Alternatively, open the Applications menu and tap **Gallery**. From Gallery you can share the file directly using various services.

You can also view your photos and videos using nemoPlayer.



.....
Note: Share options vary depending on the file type.

Geotagging

Geotagging allows you to store the location where a photo was taken right in the photo itself.

For geotag to display, pictures must be taken with **Store Location** activated in the camera settings.

To view the geotag, open the picture in the Gallery. Press the Menu button and tap **More**, then tap **Show on map**.

Chapter 9: Advanced Settings

Putting your smartphone in Airplane mode

You can enter Airplane mode (also known as flight mode) to turn off telephone and Bluetooth functions and use your smartphone as a handheld device during a flight. Check with your airline to make sure this is permitted onboard.

Switch your smartphone off during takeoff and landing as it may interfere with aircraft electronic systems.

Turning Airplane mode on or off

1. Press and hold the power button until you get the phone options menu.
2. Tap **Airplane mode** to switch it ON or OFF.

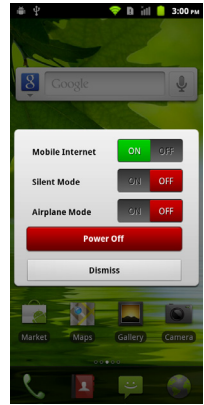

Note: When Airplane mode is active, the ✈ icon will be displayed in the Notification area.

Adjusting settings

This section will show you how to adjust detailed settings for your phone, data, Wi-Fi and Bluetooth connections.

Activating or deactivating connections

Open the Applications menu and tap **Settings > Wireless & networks** to manage your connection settings.

Each connection will have a green check when turned on.

Item	Description
Airplane mode	Disable all wireless connections so you can safely use this device onboard an aircraft.
Wi-Fi	Turn the Wi-Fi function on or off.
Wi-Fi settings	Set up and manage your wireless access points.
Bluetooth	Turn the Bluetooth function on or off.
Bluetooth settings	Manage your Bluetooth connections, set a device name and discoverability.
Tethering & portable hotspot	Share your phone's mobile data connection via USB or as a portable Wi-Fi hotspot.
VPN settings	Set up and manage Virtual Private Networks.
Mobile networks	Set your options for connecting to mobile networks.



.....
Important: If your phone is in Airplane mode, the option to turn Bluetooth on will be disabled. Please refer to **“Putting your smartphone in Airplane mode” on page 42** for instructions on turning Airplane mode on or off.
.....

Adjusting Bluetooth settings

You can use Bluetooth to exchange information between your smartphone and other mobile devices.

Bluetooth connections

For all Bluetooth settings, open the Applications menu and tap **Settings > Wireless & networks > Bluetooth settings**. Here you can switch Bluetooth on or off, set a device name and discoverability. Tap **Scan for devices** to scan for available devices.

To connect to a device, tap the device in the list of available devices. You may be asked to enter a PIN on both devices to establish the connection.

Internet sharing

Tethering via USB

If you wish to share your mobile Internet connection with a computer, you can connect your phone to a PC using the supplied USB cable.

1. Plug the USB sync cable into the micro USB connector on your smartphone.
2. Plug the USB client connector into an available USB port on your computer.
3. Tap **Settings > Wireless & network > Tethering & portable hotspot** and then tap **USB tethering**.

Wi-Fi hotspot

You can turn your smartphone into a portable Wi-Fi hotspot to share your mobile Internet connection with up to 8 clients.

1. Tap **Settings > Wireless & network > Tethering & portable hotspot > Portable Wi-Fi hotspot settings**
2. Tap **Configure Wi-Fi hotspot**.
3. Set the Network SSID and adjust security between Open and WPA2 PSK. Tap **Save** to finish.



.....
Note: When your smartphone is serving as a Wi-Fi hotspot, you can't use your phone's applications to access the Internet via its Wi-Fi connection.
.....

Phone network settings

Tap **Mobile networks** to adjust your network settings. You can turn data connection on or off when roaming, restrict the connection to 2G networks only, specify a network operator and define access point names.

Selecting a network

Your phone will automatically detect your carrier/network settings when you insert a new SIM card. However, you may prefer to manually select a network. This may be a good idea when roaming.



.....
Tip: When you are traveling, manually selecting a network may help to reduce your roaming charges. Check with your home service provider for the network offering the most competitive rates at your destination.
.....

1. Open the Applications menu and tap **Settings > Wireless & networks > Mobile networks > Network operators**.
2. Your phone will search for available networks.
3. Select your preferred network from the list generated. Your phone will attempt to register on the selected network.
4. Tap **Select automatically** to connect to the available network with the strongest signal. This may lead to your phone jumping between networks when you move around.



.....
Note: Contact your service provider should you have any problems obtaining voice mail and the text message service center numbers.
.....

Dolby Mobile

To access Dolby Mobile settings go to the applications menu and tap **Settings > Dolby Mobile**. Here you can switch Dolby Mobile on or off, set Treble, Natural Bass, Music EQ and Video EQ.

Sound

You can adjust your phone settings by tapping **Settings > Sound**.

Item	Description
Silent mode	Turn off all sounds except for alarms and media.
Vibrate	Sets vibration options.
Volume	Sets volume for Ringtone, Media, Alarm, and Notifications.
Phone ringtone	Sets your phone's ringtone.
Notification ringtone	Sets a ringtone for notifications.
Audible touch tones	Plays tones when using dial pad.
Audible selection	Plays a sound whenever a screen selection is made.
Screen lock sounds	Plays a sound when locking and unlocking the screen.
Haptic feedback	Vibrates when pressing soft keys and on certain UI interactions.
Gesture controls	Shake to mute the alarm and to switch to previous or next song.

Display

You can adjust your phone display settings by tapping **Settings > Display**.

Item	Description
Brightness	Adjust screen brightness.
Auto-rotate screen	Enable rotation of the screen when device is tilted.
Animation	Enable window animations.
Screen timeout	Set a delay before the screen will be turned off.
Touch panel sensitivity	Adjust the touch panel sensitivity.

Phone settings

Many phone settings are automatically configured by your smartphone when you insert a SIM card. The device will communicate with your provider and automatically obtain all necessary settings, such as network name, voice mail and text message center numbers.

You can also view and modify these settings manually through the Phone Settings screen.

Open the Applications menu and tap **Settings > Call settings**.

Connecting to a PC



Note: Download and install the latest USB drivers on your computer before connecting your device to the computer.
Visit www.acer.com/worldwide/support/download.htm for the latest drivers.

If you wish to transfer information between the microSD Card in your phone and your computer, you can connect your phone to a PC using the supplied USB cable. Plug the USB sync cable into the micro USB connector on your smartphone. Plug the USB client connector into an available USB port on your computer.

Pull down the notification bar, and tap **USB Connected**. Tap **Turn on USB storage**.

You will now be able to see your phone's internal memory, and any microSD Card in your phone, as two separate drives in your computer's file explorer.

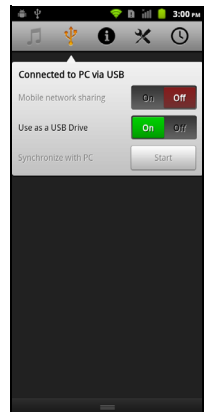

Note: After turning on USB storage, you can not use your phone to access the files in internal memory or the microSD card, or applications such as Gallery or Music.

Synchronization

You can sync your calendar, email and contacts on your phone and never worry about losing them again. Sync in real time or adjust it as you please. Tap **Menu > Settings > Accounts & sync** to access the synchronization settings.

To have your smartphone auto-sync, make sure **Background data** and **Auto-sync** are checked.

To manage synchronization of individual accounts, tap an account to see their settings.

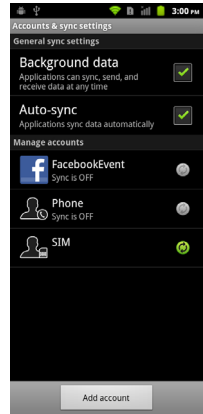

Google Sync

In Google, you can set synchronization for contacts, email and calendar. Tap to checkmark an item you would like to have auto-sync. Tap again to uncheck any for manual synchronization.

To manually synchronize an item, tap the item.



Note: You need a Google account to sync your calendar and appointments.

Acer Sync

Acer Sync allows you to easily synchronize your contacts, calendar, photos and videos between your smartphone, PC and corresponding Google services. Download and install Acer Sync and Acer PIM for the PC from mobile.acer.com.

Acer USB Fast Charge

You can quickly charge your smartphone using your Acer computer with Acer USB Fast Charge.

Download and install the Acer Fast Charge application from the Acer support site. The application detects when your Acer smartphone has been connected to your computer and increases the charging speed.

Plug the USB sync cable into the micro USB connector on your smartphone and plug the USB client connector into an available USB port on your computer. Follow the instructions in the Acer USB Fast Charge window then click **Start**.



FM radio

The FM radio allows you to listen to your favorite stations while on the move. Headset must be inserted to the 3.5 mm jack as it functions as an antenna.

You can access the radio by tapping **Radio** from the Applications menu.

Tap the power button on the upper right corner to turn the radio off.

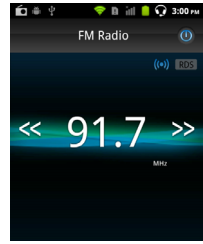

Note: Use only the Acer bundled headset when listening to the FM radio.

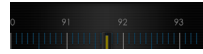

Multimedia playback

Your smartphone comes supplied with a variety of programs that you can use to enjoy multimedia content.



nemoPlayer

Open **nemoPlayer** from the Applications menu to play media you have stored on your phone.

nemoPlayer enables you to listen to music, view video clips and pictures, upload photos and videos to social networking sites or send MMS messages with photo attachments.

The following formats are supported:

Type	Formats
Audio playback	AAC, AAC+, AMR, MIDI, MP3, OGG, PCM-WAV, WMA
Ringtone	AAC, AAC+, AMR, MIDI, MP3, OGG, PCM-WAV, WMA
Video recording	MPEG4, H.263
Video playback	MPEG4, H.263, H.264, WMV, AVI



Note: Music recognition technology and related data are provided by Gracenote®. Gracenote®, Gracenote logo and logotype, and the "Powered by Gracenote" logo are either a registered trademark or a trademark of Gracenote, Inc. in the United States and/or other countries.

Acer clear.fi

With Acer clear.fi, you can share videos, photos and music over a wireless network. You may use clear.fi to play files from another device on your smartphone, control other devices using clear.fi or share videos, photos and music on your phone.

Open the applications menu and tap **clear.fi**.

Acer clear.fi will automatically detect devices that are:

1. connected to a wireless network, and
2. running Acer clear.fi (or a compatible media server).

Detected devices are displayed in a list. To see your own phone in the device list, turn on **Media Server**. Tap **Menu > Media server settings** and ensure **Share contents** is **On**.



Tap any of the connected devices and then tap the **Photo**, **Video**, or **Music** icon to browse media files on that device.

clear.fi player

Tap a device to see media files that are shared from that device. The top bar shows three categories: images, video and music. Tap a category to see appropriate media files. Tap the thumbnail of any file to view or play it on your smartphone.



Media server

Your phone can act as a digital media server using uPnP technology. This means that you can use it to send media content to other uPnP-enabled home entertainment devices that are connected to a home wireless network.

To set up the media server, open the Applications menu and tap **Media server**.

You will need to enable **Share Contents** before you can start using the service.

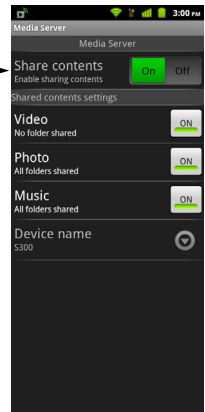
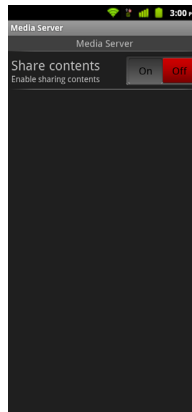

Adjusting the volume

Adjust the volume of your phone using the volume button on the side of the phone. Alternatively, you can set the **Ringer volume** and **Media volume** by opening the Applications menu and going to **Settings > Sound**.

Setting the date and time

To set the date and time, open the Applications menu and tap **Settings > Date & time**.



.....
Tip: If you travel frequently or live in an area that uses daylight saving time, activate **Automatic** from this menu. This will enable your smartphone to set the date and time based on information it receives from the network.
.....

Setting alarms

There are two predefined alarms on your phone by default. Tap **Alarm clock** in the Applications menu, and tap the alarm icon to edit alarm settings. You may:

- Turn the alarm on or off.
- Set the alarm time.
- Set which days to repeat the alarm.
- Set a ringtone.
- Enable or disable vibrate.
- Give it a label.

Changing language and text options

Set your location and language input preferences by opening the Applications menu and going to **Settings > Language & keyboard**.

Managing applications



.....
Warning! Make sure you trust the source of any program you install. If you are not sure of the source, do not install a program. Installing programs from unknown sources increases your risk of virus attacks and theft of personal and private data.
.....

Closing an application

To close an active application, go to **Settings > Applications > Manage applications**. Tap the **Running** tab, then tap the program you wish to close. Select **Force stop** to close the program.

Uninstalling an application

You can remove programs installed on your smartphone to free up extra storage memory. Tap and hold a program icon from the Applications menu and drag it into the trash can on the bottom left hand corner.

Alternatively, you can go to **Settings** from the Applications menu and select **Applications > Manage applications**. Tap the application you wish to uninstall, tap **Uninstall** and confirm the uninstall.

Here you can allow programs from **Unknown sources** to be installed and **Manage applications**.



Warning! You should only remove programs if you are familiar with the Android operating system.

Restoring to factory settings

You may perform a clean boot to restore your smartphone to the factory settings.



.....
Note: Before performing a reset, ensure that your smartphone is not locked. Press any key or tap the screen to see if the phone responds.
.....



.....
Warning! You should only perform a clean boot when all other options have failed to restore your smartphone to an operational state.
.....



.....
Warning! This will erase all your personal information, any contacts stored on your phone and any programs you installed.
.....

If your phone is responding to screen input

Open **Settings** from the Applications menu, then tap **Privacy > Factory data reset**; click **Reset phone** and then **Erase everything** to format your phone.

Chapter 10: Accessories and Tips

This chapter shows you how to use accessories with your smartphone, as well as provide useful tips for when you are using your smartphone.

Using the headset

Your smartphone comes packaged with a headset with built-in microphone for handsfree use when making calls.

To use the headset, plug it into the 3.5 mm headphone jack at the side of the phone.

When the headset is plugged in, all audio is routed to the headset, and the speakers are turned off.

- To answer an incoming call, press the button on the microphone.
- Adjust the volume using the volume up/down button on the smartphone.
- End the call by pressing the button again.

Using a Bluetooth headset

Your smartphone's Bluetooth functions make it fully compatible with all Bluetooth headsets. This allows you to use the unit handsfree when making calls, without the inconvenience of wires.

HDMI and 720P output

Your smartphone is capable of outputting audio and video content to your TV through the micro HDMI (type D) connector.

Make sure that the micro HDMI (type D) connector is properly connected to your smartphone and compatible TV. Set the TV to the proper HDMI input.

Your smartphone will show the same image on both your handset and your TV.

Creating a new access point

When you need to add another GPRS/3G/EDGE connection on your phone, obtain the access point name and settings (including username and password if required) from your wireless service provider.

1. Open the Applications menu and tap **Settings > Wireless & networks > Mobile networks > Access Point Names**.
2. Tap the **Menu** button and tap **New APN**.
3. Enter the APN settings. Tap an item to adjust it.
4. When you have finished tap the **Menu** button and tap **Save**.



.....
Important: Some providers and countries do not allow the use of a smartphone as a modem over HSDPA. Please check with your provider before attempting to do so.
.....

Inserting a microSD Card

Your smartphone features a memory expansion slot that accepts a microSD Card to expand memory and storage capacity.

Please refer to **“Installing a SIM and optional microSD Card”** on page 10 for instructions on installing a microSD Card.

Appendix

FAQ and troubleshooting

This section lists frequently asked questions that may arise during the use of your smartphone, and gives easy answers and solutions to these questions.

Aspect	Question	Answer
Audio	Why is there no sound coming from the device?	If the headset is plugged into the device, the speaker is automatically shut off. Disconnect the headset. Check that the device volume setting is not muted. Check that the volume control is not at its lowest setting.
Multimedia files	Why can't I view my picture files?	You may be trying to view an image that is not supported. Refer to "Multimedia" on page 60 for more information.
	Why can't I view my video files?	You may be trying to view a video that is not supported. Refer to "Multimedia" on page 60 for more information.
	Why can't I play my music files?	You may be trying to play a file that is not supported. Refer to "Multimedia" on page 60 for more information.
System information and performance	How do I check the OS version of my device?	Tap Menu > Settings > About phone to check the OS version (Kernel/build number) and other hardware and software information.
Power	I couldn't turn on the device.	The battery power may be depleted. Recharge the device. Refer to "Charging the battery" on page 12 for more information.
RAM / ROM	How do I check the RAM and ROM memory status?	To check the ROM status, go to Settings > SD card & phone storage . To check RAM status, go to Settings > Applications > Running services .
Unlock pattern	I forgot my unlock pattern.	After a certain number of wrong entries, you will be presented with an option to reset your pattern. Tap Forgot pattern? and enter your google account username and password.  Note: You must have an active Google account on the smartphone. Alternatively, you restore your smartphone to factory settings. See "Restoring to factory settings" on page 51 .

Aspect	Question	Answer
Heat	The phone heats up when charging or making long duration calls.	It is normal for the phone to heat up when charging. When charging is complete, it will return to its normal temperature. It is also normal for the phone to heat up during long periods of use, such as watching a video or a long phone conversation.

Other sources of help

For information on:	Refer to:
Up-to-date information regarding your smartphone	www.acer.com mobile.acer.com
Service enquiries	www.acer.com/support

Warnings and precautions

- Do not use this product near water.
- Do not place this product on an unstable cart, stand or table. If the product falls, it could be seriously damaged.
- Slots and openings are provided for ventilation to ensure reliable operation of the product and to protect it from overheating. These openings must not be blocked or covered. The openings should never be blocked by placing the product on a bed, sofa, rug or other similar surface. This product should never be placed near or over a radiator or heat register, or in a built-in installation unless proper ventilation is provided.
- Never push objects of any kind into this product through cabinet slots as they may touch dangerous voltage points or short-out parts that could result in a fire or electric shock. Never spill liquid of any kind onto or into the product.
- To avoid damage of internal components and to prevent battery leakage, do not place the product on a vibrating surface.
- Never use this product when engaging in sporting activities, exercising, or in any vibrating environment which may cause a short circuit or damage, and even a risk of explosion from the battery pack.

CAUTION when listening to music

To protect your hearing, follow these instructions.

- Increase the volume gradually until you can hear clearly and comfortably.
- Do not increase the volume level after your ears have adjusted.
- Do not listen to music at high volumes for extended periods.
- Do not increase the volume to block out noisy surroundings.
- Decrease the volume if you can't hear people speaking near you.

Battery information

This product uses a Lithium Polymer battery. Do not use it in a humid, wet and/or corrosive environment. Do not put, store or leave your product in or near a heat source, in a high temperature location, in strong direct sunlight, in a microwave oven or in a pressurized container, and do not expose it to temperatures over 60 °C (140 °F). Failure to

following these guidelines may cause the battery to leak acid, become hot, explode or ignite and cause injury and/or damage. Do not pierce, open or disassemble the battery. If the battery leaks and you come into contact with the leaked fluids, rinse thoroughly with water and seek medical attention immediately. For safety reasons, and to prolong the lifetime of the battery, charging will not occur at low (below 0 °C/32 °F) or high (over 40 °C/104 °F) temperatures.

The full performance of a new battery is achieved only after two or three complete charge and discharge cycles. The battery can be charged and discharged hundreds of times, but it will eventually wear out. When the talk and standby times are noticeably shorter than normal, buy a new battery. Use only Acer approved batteries, and recharge your battery only with Acer approved chargers designated for this device.

Unplug the charger from the electrical plug and the device when not in use. Do not leave a fully charged battery connected to the ac charger, since overcharging may shorten its lifetime. If left unused, a fully charged battery will lose its charge over time. If the battery is completely discharged, it may take a few minutes before the charging indicator appears on the display or before any calls can be made.

Use the battery only for its intended purpose. Never use any charger or battery that is damaged.

Do not short-circuit the battery. Accidental short-circuiting can occur when a metallic object such as a coin, clip, or pen causes direct connection of the positive (+) and negative (-) terminals of the battery. (These look like metal strips on the battery.) This might happen, for example, when you carry a spare battery in your pocket or purse. Short-circuiting the terminals may damage the battery or the connecting object.

Leaving the battery in hot or cold places, such as in a closed car in summer or winter conditions, will reduce the capacity and lifetime of the battery. Always try to keep the battery between 15 °C and 25 °C (59 °F and 77 °F). A device with a hot or cold battery may not work temporarily, even when the battery is fully charged. Battery performance is particularly limited in temperatures well below freezing.

Do not dispose of batteries in a fire as they may explode. Batteries may also explode if damaged. Dispose of batteries according to local regulations. Please recycle when possible. Do not dispose as household waste.

Replacing the battery pack

Your smartphone uses lithium batteries. Replace the battery with the same type as that which came bundled with your product. Use of another battery may present a risk of fire or explosion.



.....
Warning! Batteries may explode if not handled properly. Do not disassemble or dispose of them in fire. Keep them away from children. Follow local regulations when disposing of used batteries.
.....

Additional safety information

Your device and its enhancements may contain small parts. Keep them out of the reach of small children.

Operating environment



Warning! For safety reasons, turn off all wireless or radio transmitting devices when using your smartphone device under the following conditions. These devices may include, but are not limited to: wireless LAN (WLAN), Bluetooth and/or 3G.

Remember to follow any special regulations in force in any area, and always switch off your device when its use is prohibited or when it may cause interference or danger. Use the device only in its normal operating positions. To successfully transmit data files or messages, this device requires a good quality connection to the network. In some cases, transmission of data files or messages may be delayed until such a connection is available. Ensure that the above separation distance instructions are followed until the transmission is completed. Parts of the device are magnetic. Metallic materials may be attracted to the device, and persons with hearing aids should not hold the device to the ear with the hearing aid. Do not place credit cards or other magnetic storage media near the device, because information stored on them may be erased.

Medical devices

Operation of any radio transmitting equipment, including wireless phones, may interfere with the functionality of inadequately protected medical devices. Consult a physician or the manufacturer of the medical device to determine if they are adequately shielded from external RF energy or if you have any questions. Switch off your device in health care facilities when any regulations posted in these areas instruct you to do so. Hospitals or health care facilities may be using equipment that could be sensitive to external RF transmissions.

Pacemakers. Pacemaker manufacturers recommend that a minimum separation of 15.3 cm (6") be maintained between wireless devices and a pacemaker to avoid potential interference with the pacemaker. These recommendations are consistent with the independent research by and recommendations of Wireless Technology Research. Persons with pacemakers should do the following:

- Always keep the device more than 15.3 cm (6") from the pacemaker.
- Not carry the device near your pacemaker when the device is switched on. If you suspect interference, switch off your device, and move it.

Hearing aids. Some digital wireless devices may interfere with some hearing aids. If interference occurs, consult your service provider.

Vehicles

RF signals may affect improperly installed or inadequately shielded electronic systems in motor vehicles such as electronic fuel injection systems, electronic anti-skid (anti-lock) braking systems, electronic speed control systems, and air bag systems. For more information, check with the manufacturer, or its representative, of your vehicle or any equipment that has been added. Only qualified personnel should service the device, or install the device in a vehicle. Faulty installation or service may be dangerous and may invalidate any warranty that may apply to the device. Check regularly that all wireless equipment in your vehicle is mounted and operating properly. Do not store or carry flammable liquids, gases, or explosive materials in the same compartment as the device, its parts, or enhancements. For vehicles equipped with an air bag, remember that air bags inflate with great force. Do not place objects, including installed or portable wireless equipment in the area over the air bag or in the air bag deployment area. If in-vehicle

wireless equipment is improperly installed, and the air bag inflates, serious injury could result. Using your device while flying in aircraft is prohibited. Switch off your device before boarding an aircraft. The use of wireless teledevices in an aircraft may be dangerous to the operation of the aircraft, disrupt the wireless telephone network, and may be illegal.

Potentially explosive environments

Switch off your device when in any area with a potentially explosive atmosphere and obey all signs and instructions. Potentially explosive atmospheres include areas where you would normally be advised to turn off your vehicle engine. Sparks in such areas could cause an explosion or fire resulting in bodily injury or even death. Switch off the device at refueling points such as near gas pumps at service stations. Observe restrictions on the use of radio equipment in fuel depots, storage, and distribution areas; chemical plants; or where blasting operations are in progress. Areas with a potentially explosive atmospheres are often, but not always, clearly marked. They include below deck on boats, chemical transfer or storage facilities, vehicles using liquefied petroleum gas (such as propane or butane), and areas where the air contains chemicals or particles such as grain, dust or metal powders.

Follow any restrictions. Do not use the device where blasting is in progress.

Emergency calls

Important: Wireless phones, including this device, operate using radio signals, wireless networks, landline networks, and user-programmed functions. Because of this, connections in all conditions cannot be guaranteed. You should never rely solely on any wireless device for essential communications like medical emergencies.

If certain features are in use, you may first need to turn those features off before you can make an emergency call. Consult this guide or your service provider for more information.

When making an emergency call, give all the necessary information as accurately as possible. Your wireless device may be the only means of communication at the scene of an accident. Do not end the call until given permission to do so.

Disposal and recycling information



Do not throw this electronic device into the trash when discarding.

To minimize pollution and ensure utmost protection of the global environment, please recycle. For more information on the Waste from Electrical and Electronics Equipment (WEEE) regulations, visit www.acer-group.com/public/Sustainability/sustainability01.htm

Mercury advisory



For projectors or electronic products containing an LCD/CRT monitor or display: Lamp(s) inside this product contain mercury and must be recycled or disposed of according to local, state or federal laws. For more information, contact the Electronic Industries Alliance at www.eiae.org. For lamp-specific disposal

information, check www.lamprecycle.org.

Taking care of your smartphone

1. **DO** take care not to scratch the screen of your smartphone. Keep the screen clean. When working with your smartphone, use your finger or fingernail. Never use an actual pen or pencil or other sharp object on the screen surface.
2. **DO NOT** expose your smartphone to rain or moisture. Do not let water enter the circuitry through the front panel buttons or expansion slots. In general, treat your smartphone as you would a mobile phone or other small electronic device.
3. **DO** be careful not to drop your smartphone or subject it to any strong impact. Do not place your smartphone in your back pocket.
4. **DO NOT** expose your smartphone to extreme temperatures. For example, do not leave your smartphone on the dashboard of a car on a hot day or when temperatures are below freezing point. Also, keep it away from heaters and other sources of heat.
5. **DO NOT** use or store your smartphone in any location that is dusty, damp or wet.
6. **DO** use a soft, damp cloth to clean your smartphone. If the surface of the screen becomes soiled, clean it with a soft cloth moistened with diluted window-cleaning solution.
7. **DO NOT** press down on the screen with force, otherwise you may crack the screen.

Specifications

Performance

- Qualcomm MSM8255-1, 1 GHz
- System memory:
 - 512 MB of SDRAM
 - 512 MB of Flash ROM
- Google Android operating system

Display

- 4.8" HXGA TFT, Capacitive Touch Panel
- 1024 x 480 resolution
- 16M colors support

Multimedia

- CD-quality stereo output
- Mono speaker 0.5 W (max)
- Dual microphone
- Formats supported

Type	Formats
Audio playback	AAC, AAC+, AMR, MIDI, MP3, OGG, PCM-WAV, WMA
Ringtone	AAC, AAC+, AMR, MIDI, MP3, OGG, PCM-WAV, WMA
Video recording	MPEG-4, H.263
Video playback	MPEG-4, H.263, H.264, WMV, AVI

USB connector

- Micro USB connector
- USB Client
- DC power-in (5 V, 1 A)

Connectivity

- Bluetooth 2.1+EDR
- IEEE Wi-Fi 802.11 b/g/n WLAN
- GSM 850 / 900 / 1800 / 1900
- UMTS 900 / 1900 / 2100 (EU models)
- UMTS 850 / 1900 / 2100 (US models)
- HSDPA / HSUPA / GPRS / EDGE

Camera

- 8-megapixel with auto focus and LED flashlight
- 2-megapixel (front-facing camera)

Expansion

- microSD memory card (up to 32 GB)

GPS

- Built-in GPS
- Supports AGPS

Battery

- High density, rechargeable 1500 mAh Lithium-Ion battery (replaceable)



.....
Note: Length of battery operation will depend on power consumption which is based on system resource use. For example, constantly using the backlight or using power-demanding applications will shorten battery life between charges.
.....

Dimensions

Height	141.7 mm
Width	64.5 mm
Thickness	13.6 mm
Weight	<185 g (with battery)

Regulatory information

Compliant with Russian regulatory certification



ME61

RoHS compliance

This product is in compliance with Directive 2002/95/EC of the European Parliament and of the Council of 27 January 2003, on the restriction of the use of certain hazardous substances in electrical and electronic equipment (RoHS) and its amendments.

LCD pixel statement

The LCD unit is produced with high-precision manufacturing techniques. Nevertheless, some pixels may occasionally misfire or appear as black or red dots. This has no effect on the recorded image and does not constitute a malfunction.

Radio device regulatory notice



Note: Regulatory information below is for models with wireless LAN and/or Bluetooth only.

General

This product complies with the radio frequency and safety standards of any country or region in which it has been approved for wireless use. Depending on configuration, this product may or may not contain wireless radio devices (such as wireless LAN and/or Bluetooth modules). Information below is for products with such devices.

Preventing hearing loss



Caution: Permanent hearing loss may occur if earphones or headphones are used at high volume for prolonged periods of time.

This device has been tested to comply with the Sound Pressure Level requirement laid down in the applicable EN 50332-1 and/or EN 50332-2 standards.



Note: For France, mobile headphones or earphones for this device have been tested to comply with the Sound Pressure requirement laid down in the applicable NF EN 50332-1:2000 and/or NF EN 50332-2:2003 standards as required by French Article L. 5232-1.

A pleine puissance, l'écoute prolongée du baladeur peut endommager l'oreille de l'utilisateur.

Wireless operation channels for different domains

N. America	2.412-2.462 GHz	Ch01 through Ch11
Japan	2.412-2.484 GHz	Ch01 through Ch14
Europe ETSI	2.412-2.472 GHz	Ch01 through Ch13

France: Restricted wireless frequency bands

Some areas of France have a restricted frequency band. The worst case maximum authorized power indoors is:

- 10 mW for the entire 2.4 GHz band (2400 MHz - 2483.5 MHz)
- 100 mW for frequencies between 2446.5 MHz and 2483.5 MHz



.....
Note: Channels 10 through 13 inclusive operate in the band 2446.6 MHz to 2483.5 MHz.
.....

There are few possibilities for outdoor use: On private property or on the private property of public persons, use is subject to a preliminary authorization procedure by the Ministry of Defense, with maximum authorized power of 100 mW in the 2446.5 - 2483.5 MHz band. Use outdoors on public property is not permitted.

In the departments listed below, for the entire 2.4 GHz band:

- Maximum authorized power indoors is 100 mW
- Maximum authorized power outdoors is 10 mW

Departments in which the use of the 2400 - 2483.5 MHz band is permitted with an EIRP of less than 100 mW indoors and less than 10 mW outdoors:

01 Ain Orientales	24 Dordogne	55 Meuse	68 Haut Rhin
02 Aisne	25 Doubs	58 Nièvre	70 Haute Saone
03 Allier	26 Drome	59 Nord	71 Saone et Loire
05 Hautes Alpes	32 Gers	60 Oise	75 Paris
08 Ardennes	36 Indre	61 Orne	82 Tarn et Garonne
09 Ariege	37 Indre et Loire	63 Puy Du Dome	84 Vaucluse
11 Aude	41 Loir et Cher	64 Pyrenees Atlantique	88 Vosges
12 Aveyron	45 Loret	66 Pyrenees	89 Yonne
16 Charente	50 Manche	67 Bas Rhin	90 Territoire de Belfort
			94 Val de Marne

This requirement is likely to change over time, allowing you to use your wireless LAN card in more areas within France.

Please check with ART for the latest information (www.art-telecom.fr).



.....
Note: Your WLAN Card transmits less than 100 mW, but more than 10 mW.
.....

List of National Codes

This equipment may be operated in the following countries:

Country	ISO 3166 (2 letter code)	Country	ISO 3166 (2 letter code)
Austria	AT	Malta	MT
Belgium	BE	Netherlands	NT
Cyprus	CY	Poland	PL
Czech Republic	CZ	Portugal	PT
Denmark	DK	Slovakia	SK
Estonia	EE	Slovenia	SL
Finland	FI	Spain	ES
France	FR	Sweden	SE
Germany	DE	United Kingdom	GB
Greece	GR	Iceland	IS
Hungary	HU	Liechtenstein	LI
Ireland	IE	Norway	NO
Italy	IT	Switzerland	CH
Latvia	LV	Bulgaria	BG
Lithuania	LT	Romania	RO
Luxembourg	LU	Turkey	TR

FCC regulations

This mobile phone complies with part 15 of the FCC Rules. Operation is subject to the following two conditions: (1) This device may not cause harmful interference, and (2) this device must accept any interference received, including interference that may cause undesired operation.

This mobile phone has been tested and found to comply with the limits for a Class B digital device, pursuant to Part 15 of the FCC Rules. These limits are designed to provide reasonable protection against harmful interference in a residential installation. This equipment generates, uses and can radiated radio frequency energy and, if not installed and used in accordance with the instructions, may cause harmful interference to radio communications. However, there is no guarantee that interference will not occur in a particular installation. If this equipment does cause harmful interference to radio or television reception, which can be determined by turning the equipment off and on, the user is encouraged to try to correct the interference by one or more of the following measures:

- Reorient or relocate the receiving antenna.
 - Increase the separation between the equipment and receiver.
 - Connect the equipment into an outlet on a circuit different from that to which the receiver is connected.
 - Consult the dealer or an experienced radio/TV technician for help.
- Changes or modifications not expressly approved by the party responsible for compliance could void the user's authority to operate the equipment.

RF exposure warning

The equipment complies with FCC RF exposure limits set forth for an uncontrolled environment.

The antenna(s) used for this transmitter must not be co-located or operating in conjunction with any other antenna or transmitter.

RF exposure information (SAR)

This mobile phone meets the government's requirements for exposure to radio waves.

This phone is designed and manufactured not to exceed the emission limits for exposure to radio frequency (RF) energy set by the Federal Communications Commission of the U.S. Government.

The exposure standard for wireless mobile phones employs a unit of measurement known as the Specific Absorption Rate, or SAR. The SAR limit set by the FCC is 1.6 W/kg.

Tests for SAR are conducted using standard operating positions accepted by the FCC with the phone transmitting at its highest certified power level in all tested frequency bands. Although the SAR is determined at the highest certified power level, the actual SAR level of the phone while operating can be well below the maximum value. This is because the phone is designed to operate at multiple power levels so as to use only the power required to reach the network. In general, the closer you are to a wireless base station antenna, the lower the power output.

The highest SAR value for US model phones as reported to the FCC when tested for use at the ear is 0.355 W/kg and when worn on the body, as described in this user guide, is 0.856 W/kg.



.....
Important: Body-worn measurements differ among phone models, depending upon available enhancements and FCC requirements.
.....

While there may be differences between the SAR levels of various phones and at various positions, they all meet the government requirements.

The FCC has granted an Equipment Authorization for this model phone with all reported SAR levels evaluated as in compliance with the FCC RF exposure guidelines. SAR information on this model phone is on file with the FCC and can be found under the Display Grant section of www.fcc.gov/oet/ea/fccid after searching on **FCC ID: HLZJMS300** (for US models).

For body worn operation, this phone has been tested and meets the FCC RF exposure guidelines for use with accessories that contain no metal and that position the handset a minimum of 1 cm from the body. Use of other accessories may not ensure compliance with FCC RF exposure guidelines. If you do not use a body-worn accessory and are not holding the phone at the ear, position the handset a minimum of 1 cm from your body when the phone is switched on.

Using your phone with a hearing aid device (US models)

Your device is compliant with the FCC Hearing Aid Compatibility (HAC) requirements. When some wireless phones are used near some hearing devices (hearing aids and cochlear implants) users may detect a buzzing, humming, or whining noise. Some hearing devices are more immune than others to this interference noise, and phones also vary in the amount of interference they generate. The wireless telephone industry has developed ratings for some of their mobile phones, to assist hearing-device users in finding phones that may be compatible with their hearing devices. Not all phones have been rated. Phones that have been rated have a label on the box. Your device has been tested for hearing aid device compatibility and has an M4 rating.

These ratings are not guarantees. Results will vary, depending on the level of immunity of your hearing device and the degree of your hearing loss. If your hearing device happens to be vulnerable to interference, you may not be able to use a rated phone successfully.

Trying out the phone with your hearing device is the best way to evaluate it for your personal needs.

M-Ratings: Phones rated M3 or M4 meet FCC requirements and are likely to generate less interference with hearing devices than phones that are not labeled. M4 is the better/higher of the two ratings.

T-Ratings: Phones rated T3 or T4 meet FCC requirements and are likely to be more usable with a hearing device's telecoil ("T Switch" or "Telephone Switch") than unrated phones. T4 is the better/higher of the two ratings.



.....
Important: This device does not support VoIP. WLAN and Bluetooth do not have voice capability for held-to-the-ear phone service.
.....



.....
Note: Not all hearing devices contain telecoils.
.....

The more immune your hearing aid device is, the less likely you are to experience interference noise from your wireless phone. Hearing aid devices should have ratings similar to those of phones. Ask your hearing health-care professional for the rating of your hearing aid.

Hearing devices may also be measured for immunity to this type of interference. Your hearing device manufacturer or hearing health professional may help you find results for your hearing device. The more immune your hearing aid is, the less likely you are to experience interference noise from wireless devices.

For additional information about the FCC's actions with regard to hearing aid compatible wireless devices and other steps the FCC has taken to ensure that individuals with disabilities have access to telecommunications services, please go to www.fcc.gov/cgb/dro.

Turning on Hearing Aid Compatibility mode

To turn on HAC, open the Applications menu and tap **Settings > Call settings > Advanced settings > Hearing aids**.

For Canadian users

Operation is subject to the following two conditions: (1) this device may not cause interference, and (2) this device must accept any interference, including interference that may cause undesired operation of the device.

This Class B digital apparatus complies with Canadian ICES-003.

Cet appareil numérique de la classe B est conforme à la norme NMB-003 du Canada.

This Category II radiocommunication device complies with Industry Canada Standard RSS-310.

Ce dispositif de radiocommunication de catégorie II respecte la norme CNR-310 d'Industrie Canada.

Important note

IC radiation exposure statement

This EUT is compliance with SAR for general population/uncontrolled exposure limits in IC RSS-102 and had been tested in accordance with the measurement methods and

procedures specified in IEEE 1528. This equipment should be installed and operated with minimum distance 1 cm between the radiator and your body.

This device and its antenna(s) must not be co-located or operating in conjunction with any other antenna or transmitter.



Note: The county code selection feature is disabled for products marketed in the US/Canada.

Certificate Information (SAR)

This device meets the EU requirements (1999/519/EC) on the limitation of exposure of the general public to electromagnetic fields by way of health protection.

The limits are part of extensive recommendations for the protection of the general public. These recommendations have been developed and checked by independent scientific organizations through regular and thorough evaluations of scientific studies. To guarantee the safety of all persons, regardless of age and health, the limits include a significant safety buffer.

Before radio devices can be put in circulation, their agreement with European laws or limits must be confirmed; only then may the CE symbol be applied.

The unit of measurement for the European Council's recommended limit for mobile telephones is the "Specific Absorption Rate" (SAR). This SAR limit is 2.0 W/kg, averaged over 10 g of body tissue. It meets the requirements of the International Commission on Non-Ionizing Radiation Protection (ICNIRP) and was included in the European Standard EN 50360 for mobile radio devices. The SAR regulation for mobile telephones is in line with European Standard EN 62209-1. The maximum SAR value is calculated at the highest output level in all frequency bands of the mobile telephone.

For body worn operation, this phone (EU model) has been tested and meets the ICNIRP exposure guidelines, and was included in the European Standard EN 62311 and EN 62209-2 for use with accessories that contain no metal and that position the handset a minimum of 1.5 cm from the body. Use of other accessories may not ensure compliance with ICNIRP exposure guidelines. If you do not use a body worn accessory and are not holding the phone at the ear, position the handset a minimum of 1.5 cm from your body when the phone is switched on.

During use, the actual SAR level is usually much lower than the maximum value, because the mobile telephone works in different output levels. It only transmits with as much output as is required to reach the network. In general the following applies: The closer you are to a base station, the lower the transmission output of your mobile telephone. The tested SAR of this device is as follows:

FCC		CE		NCC
Head (W/kg)	Body (W/kg)	Head (W/kg)	Body (W/kg)	Head (W/kg)
0.355	0.856	0.181	0.467	0.181

NCC warning

警語

經型式認證合格之低功率射頻電機，非經許可，公司、商號或使用者均不得擅自變更頻率、加大功率或變更原設計之特性及功能。低功率射頻電機之使用不得影響飛航安全及干擾合法通信；經發現有干

擾現象時，應立即停用，並改善至無干擾時方得繼續使用。前項合法通信，指依電信法規定作業之無線電通信。低功率射頻電機須忍受合法通信或工業、科學及醫療用電波輻射性電機設備之干擾，減少電磁波影響，請妥善使用。



Note: SAR 標準值 2.0 W/kg; 送測產品實測值為 : 0.181 W/kg

Lithium-ion battery warning



ATTENZIONE! Rischio di esplosione della batteria se sostituita in modo errato. Sostituire la batteria con un una di tipo uguale o equivalente consigliata dalla fabbrica. Non disperdere le batterie nell'ambiente.



VORSICHT! Explosionsgefahr bei unsachgemäßen Austausch der Batterie. Ersatz nur durch denselben oder einem vom Hersteller empfohlenem ähnlichen Typ. Entsorgung gebrauchter Batterien nach Angaben des Herstellers.



ADVARSELI! Lithiumbatteri - Eksplosionsfare ved fejlagtig håndtering. Udskiftning må kun ske med batteri af samme fabrikat og type. Levér det brugte batteri tilbage til leverandøren.



VARNING! Explosionsfara vid felaktigt batteribyte. Använd samma batterityp eller en ekvivalent typ som rekommenderas av apparattillverkaren. Kassera använt batteri enligt fabrikantens instruktion.



VAROITUS! Paristo voi räjähtää, jos se on virheellisesti asennettu. Vaihda paristo ainoastaan laitevalmistajan suosittelemaan tyyppiin. Hävitä käytetty paristo valmistajan ohjeiden mukaisesti.



ATTENTION! Il y a danger d'explosion s'il y a remplacement incorrect de la batterie. Remplacer uniquement avec une batterie du même type ou d'un type équivalent recommandé par le constructeur. Mettre au rebut les batteries usagées conformément aux instructions du fabricant.



ADVARSEL! Eksplosjonsfare ved feilaktig skifte av batteri. Benytt samme batteritype eller en tilsvarende type anbefalt av apparatfabrikanten. Brukte batterier kasseres i henhold til fabrikantens instruksjoner.

Declaration of Conformity

We, Acer Incorporated,
of 8F., No.88, Sec. 1, Xintai 5th Rd., Xizhi Dist., New Taipei City 22181, Taiwan (R.O.C)
Declare under sole responsibility that the product:

Model: S300
Description: Smart HandHeld

To which this declaration relates, is in conformity with the following standards and/ or other normative documents:

- EN 301 511 V9.0.2
- EN 301 908-1 V4.2.1 ; EN 301908-2 V4.2.1
- EN 300 328 V1.7.1
- EN 300 440-1 V1.6.1 ; EN300 440-2 V1.4.1
- EN 301 489-1 V1.8.1 ; EN 301489-3 V1.4.1 ; EN 301489-7 V1.3.1
- EN 301489-17 V2.1.1 ; EN 301489-24 V1.5.1 ;
- EN 55022:2006/A1:2007 Class B ; EN 55024:1998/A1:2001/A2:2003
- EN 55013:2001/A1:2003/A2:2006 ; EN 55020:2007
- EN 60950-1: EN 60950-1:2006+A1:2010
- EN 50332-1:2000 ; EN 50332-2: 2003
- EN 50360:2001/AC : 2006 ; EN 62209-1:2006; EN62311:2008; EN62209-2:2010

We hereby declare that the above named product is in conformance to all the essential requirements of the R&TTE Directive (99/5/EC) issued by the Commission of the European Community.

The conformity assessment procedure referred to in Article 10 and detailed in Annex [IV] of directive 1999/5/EC has been followed related to Articles

- R&TTE Article 3.1 (a) Health and Safety
- R&TTE Article 3.1 (b) EMC
- R&TTE Article 3.2 Spectrum Usage

with the involvement of the following Notified Body:

CETECOM, Untertuerkheimer Str. 6 – 10 66117 Saarbruecken

Identification mark: **0682** (Notified Body) CE

The technical documentation relevant to the above equipment will be held at:

Acer Incorporated

8F., No.88, Sec. 1, Xintai 5th Rd., Xizhi Dist., New Taipei City 22181, Taiwan R.O.C

Authorized Person:

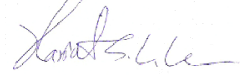

Name: Harriot SL Lee