

Aspire 3680/5570/5580 Series Service Guide

Service guide files and updates are available on the ACER/CSD web; for more information, please refer to <http://csd.acer.com.tw>

PRINTED IN TAIWAN

Revision History

Please refer to the table below for the updates made on Aspire 3680/5570/5580 service guide.

Date	Chapter	Updates

Copyright

Copyright © 2006 by Acer Incorporated. All rights reserved. No part of this publication may be reproduced, transmitted, transcribed, stored in a retrieval system, or translated into any language or computer language, in any form or by any means, electronic, mechanical, magnetic, optical, chemical, manual or otherwise, without the prior written permission of Acer Incorporated.

Disclaimer

The information in this guide is subject to change without notice.

Acer Incorporated makes no representations or warranties, either expressed or implied, with respect to the contents hereof and specifically disclaims any warranties of merchantability or fitness for any particular purpose. Any Acer Incorporated software described in this manual is sold or licensed "as is". Should the programs prove defective following their purchase, the buyer (and not Acer Incorporated, its distributor, or its dealer) assumes the entire cost of all necessary servicing, repair, and any incidental or consequential damages resulting from any defect in the software.

Acer is a registered trademark of Acer Corporation.

Intel is a registered trademark of Intel Corporation.

Pentium and Pentium II/III are trademarks of Intel Corporation.

Other brand and product names are trademarks and/or registered trademarks of their respective holders.

Conventions

The following conventions are used in this manual:

SCREEN MESSAGES	Denotes actual messages that appear on screen.
NOTE	Gives bits and pieces of additional information related to the current topic.
WARNING	Alerts you to any damage that might result from doing or not doing specific actions.
CAUTION	Gives precautionary measures to avoid possible hardware or software problems.
IMPORTANT	Reminds you to do specific actions relevant to the accomplishment of procedures.

Preface

Before using this information and the product it supports, please read the following general information.

1. This Service Guide provides you with all technical information relating to the BASIC CONFIGURATION decided for Acer's "global" product offering. To better fit local market requirements and enhance product competitiveness, your regional office MAY have decided to extend the functionality of a machine (e.g. add-on card, modem, or extra memory capability). These LOCALIZED FEATURES will NOT be covered in this generic service guide. In such cases, please contact your regional offices or the responsible personnel/channel to provide you with further technical details.
2. Please note WHEN ORDERING FRU PARTS, that you should check the most up-to-date information available on your regional web or channel. If, for whatever reason, a part number change is made, it will not be noted in the printed Service Guide. For ACER-AUTHORIZED SERVICE PROVIDERS, your Acer office may have a DIFFERENT part number code to those given in the FRU list of this printed Service Guide. You MUST use the list provided by your regional Acer office to order FRU parts for repair and service of customer machines.

Chapter 1	System Specifications	1
	Features	1
	System Block Diagram	4
	Board Layout	5
	Top View	5
	Bottom View	6
	Your Acer Notebook tour	8
	Front View	8
	Closed Front View	9
	Left View	10
	Right View	11
	Rear Panel	11
	Bottom Panel	12
	Indicators	12
	Easy-Launch Buttons	14
	Touchpad Basics	14
	Using the Keyboard	16
	Lock Keys and embedded numeric keypad	16
	Windows Keys	16
	Hot Keys	17
	Special Key	18
	Acer Empowering Technology	20
	Empowering Technology password	20
	Acer eNet Management (for selected models)	20
	Acer ePower Management	22
	Acer ePresentation Management	24
	Acer eDataSecurity Management (for selected models)	25
	Acer eLock Management	27
	Acer eRecovery Management	28
	Acer eSettings Management	29
	Acer ePerformance Management	29
	Acer OrbiCam	30
	Using the System Utilities	34
	Acer GridVista (dual-display compatible)	34
	Launch Manager	35
	Hardware Specifications and Configurations	36
Chapter 2	System Utilities	47
	BIOS Setup Utility	47
	Navigating the BIOS Utility	48
	Information	49
	Main	50
	Advanced	52
	Security	53
	Boot	57
	Exit	58
	BIOS Flash Utility	59
	Remove HDD/BIOS Utility	60
Chapter 3	Machine Disassembly and Replacement	65
	General Information	66
	Before You Begin	66
	Disassembly Procedure Flowchart	67
	Removing the Battery Pack	69

Table of Contents

Removing the HDD Module/the Memory/the Wireless LAN Card/ the Modem Board/the ODD Module and the LCD Module	70
Removing the HDD Module	70
Removing the Memory/the Wireless LAN Card/the Modem Board	70
Removing the ODD Module	71
Removing the LCD Module (including Keyboard)	71
Disassembling the Main Unit	73
Separating the Main Unit into Upper Case and Lower Case Assembly	73
Disassembling the Upper Case Assembly	73
Disassembling the Lower Case Assembly	73
Disassembling the LCD Module (with video camera)	75
Disassembling the External Modules	77
Disassembling the HDD Module	77
Disassembling the ODD Module	77
Chapter 4 Troubleshooting	79
System Check Procedures	80
External Diskette Drive Check	80
External CD-ROM Drive Check	80
Keyboard or Auxiliary Input Device Check	80
Memory check	81
Power System Check	81
Touchpad Check	83
Power-On Self-Test (POST) Error Message	84
Index of Error Messages	85
Phoenix BIOS Beep Codes	88
Index of Symptom-to-FRU Error Message	92
Intermittent Problems	95
Undetermined Problems	96
Chapter 5 Jumper and Connector Locations	97
Top View	97
Bottom View	98
Chapter 6 FRU (Field Replaceable Unit) List	101
Aspire 3680/5570/5580 Exploded Diagram	102
Appendix A Model Definition and Configuration	114
Aspire 3680 Series	114
Aspire 5570 Series	124
Aspire 5580 Series	128
Appendix B Test Compatible Components	129
Microsoft® Windows® XP Pro Environment Test	130
Microsoft® Windows® XP Home Environment Test	132
Appendix C Online Support Information	135

System Specifications

Features

Below is a brief summary of the computer's many features:

Platform and memory

- Intel® Centrino® Duo mobile technology, featuring
 - Intel® Core 2 Duo processor T5500/T5600 (2MB L2 cache, 1.66/1.83 GHz, 667 MHz FSB) and T7200/T7400/T7600 (4 MB L2 cache, 2/2.16/2.33 GHz, 667 MHz FSB) (**for Aspire 5580**)
 - Intel® Core Duo processor T2300/T2400/T2500/T2600 (2MB L2 cache, 1.66/1.83/2/2.16 GHz, 667 MHz FSB) (**for Aspire 5570**)
 - Mobile Intel® 945GM (for Aspire 5570)/945PM (for Aspire 5580) +ICH7M
 - Intel PRO/Wireless 3945ABG network connection (dual-band tri-mode 802.11a/b/g) or Intel PRO/Wireless 3945BG network connection (dual-mode 802.11b/g)
- Intel Celeron M processor 410/420/430 (1 MB L2 cache, 1.46/1.60/1.73 GHz, 533 MHz FSB) or higher (**for Aspire 3680**)
- Mobile Intel 940GML+ICH7M (**for Aspire 3680**)
- Up to 2 GB of DDR2 533/677 MHz system memory, upgradeable to 4 GB using two soDIMM modules (dual-channel support)
- 256/512 MB of DDR2 533 MHz memory, upgradeable to 2 GB using two soDIMM modules (dual-channel support) (**for Aspire 3680**)

Display and graphics

- 14.1" WXGA Acer CrystalBrite™ TFT LCD, 1280 x 800 pixel resolution, supporting simultaneous multi-window viewing on dual displays via Acer GridVista™ (for selected models)
- NVIDIA® GeForce Go 7300 up to 256 MB TurboCache (128 MB of dedicated GDDR2 VRAM, up to 128 MB of shared system memory), supporting Microsoft® DirectX 9.0, Shader Model 3.0, OpenEXR High Dynamic Range (HDR) technology, NVIDIA® PowerMizer™ 6.0 PCI Express® (for selected models)
- Mobile Intel® 940GML Express chipset with integrated 3D graphics, featuring Intel® Graphics Media Accelerator (GMA) 950, up to 224 MB of shared system memory, supporting Microsoft® DirectX® 9.0 dual independent display (**for Aspire 3680**)
- 16.7 million colors
- Simultaneous LCD and CRT display, with LCD panel refresh rate at 70Hz
- Up to 2048 x 1536 resolution via non-interlaced CRT display
- MPEG-2/DVD hardware-assisted capability
- Acer CinemaVision™ video technology (Acer Arcade)
- Acer ClearVision™ video optimization (Acer Arcade)

Storage subsystem

- 40/60/80/100/120/160 GB hard disk drive
- Optical drive options:
 - 8X DVD-Super Multi double-layer
 - DVD/CD-RW combo (for selected models)
- 5-in 1 card reader, supporting Memory Stick®(MS), Memory Stick PRO™ (MS PRO),

MultiMediaCard (MMC), Secure Digital (SD), and xD-Picture Card™ (xD)

Input devices

- 88/89-key keyboard
- Touchpad with 4-way scroll button
- Four easy-launch buttons
- Six media keys: volume up/down, play/pause, stop, next, previous (for selected models)
- Two front-access LED-switches: WLAN, Bluetooth®

Audio

- Audio system with two built-in 1.5W speakers
- Intel® High-Definition audio support
- Sound Blaster Pro™ and MS Sound compatible
- S/PDIF (Sony/Philips Digital Interface) support for digital speakers
- Built-in microphone

Communication

- Acer Video Conference featuring Voice and Video over Internet Protocol (VVoIP) support via Acer OrbiCam™ and optional Acer Bluetooth VoIP phone
- Acer OrbiCam™ 1.3 megapixel/310,000 pixel CMOS camera (LCD panel-mounted), featuring:
 - 225 degree ergonomic rotation
 - Acer PrimaLite™ technology
- WLAN:
 - Intel® PRO Wireless 3945AGB network connection (dual-band tri-mode 802.11a/b/g) or Intel® PRO/Wireless 3945BG network connection (dual-mode 802.11b/g) Wi-Fi CERTIFIED solution, supporting Acer SignalUp wireless technology
 - Acer InViLink™ 802.11b/g Wi-Fi CERTIFIED™ solution, supporting Acer SignalUp™ wireless technology (for Aspire 3680)
- WPAN: Bluetooth® 2.0+EDR (Enhanced Data Rate)
- LAN: Fast Ethernet; Wake-on-LAN ready
 - Gigabit Ethernet; Wake-in-LAN ready (for
 - Fast Ethernet; Wake-on-LAN ready
- Modem: 56K ITU V.92 modem with PTT approval; Wake-on ring ready

I/O Ports

- PC Card slot (one Type II)
- 5-in-1 card reader (MS/MS PRO/MMC/SD/xD)
- Three USB 2.0 ports
- IEEE 1394 port (4-pin) (for selected models, yet for Aspire 3680/5570/5580, there is no IEEE 1394 port)
- Infrared port (for selected models, yet for Aspire 3680/5570/5580, there is no Infrared port)
- External display (VGA) port
- S-Video/TV-out (NTSC/PAL) port
- Headphones/speaker/line-out jack with S/PDIF support
- Microphone-in jack
- Line-in jack
- Ethernet (RJ-45) port

-
- Modem (RJ-11) port
 - DC-in jack for AC adapter

Environment

- Temperature:
 - ▶operating: 5° C to 35° C
 - ▶Non-operating: -20° C to 65° C
- Humidity (non-condensing):
 - ▶operating: 20%~80%
 - ▶Non-operating: 20%~80%

Board Layout

Top View

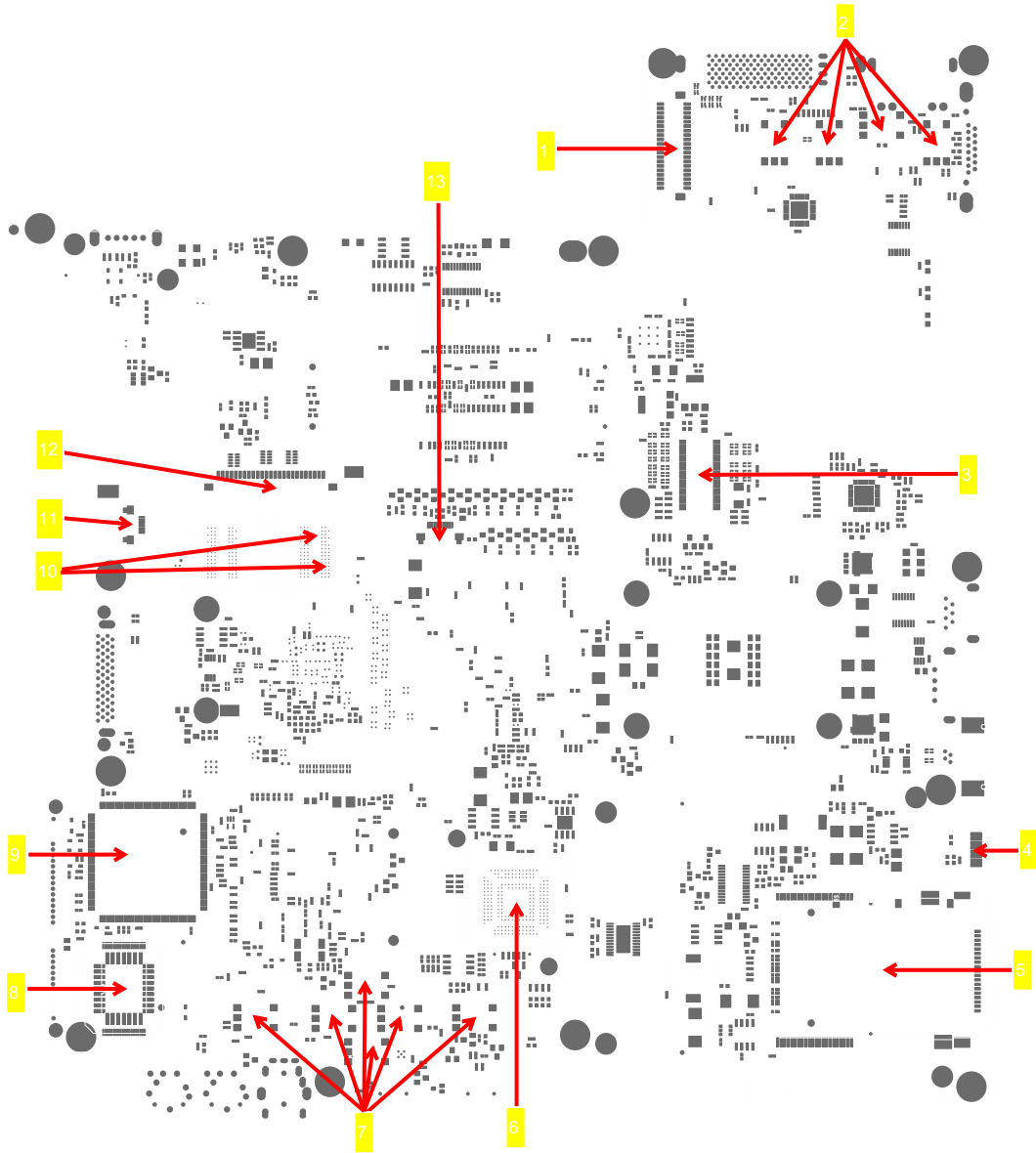

1	CN1	LVDS CONN	8	U18	BIOS
2	SW1-4	QUICK KEY SWITCH	9	U13	KB CONTROLLER (87541V)
3	U3	LCOCK GENERATOR	10	U5-6	G72M-VRAM
4	U12	FIR	11	CN3	MEDIA CONN
5	CN5-6	5-IN-1 MMC/SD/MS/MS Pro/xD CARD READER CONN	12	CN2	K/B CONN
6	U14	PCI8412/6412	13	CN4	TP/B CONN
7	SW5-10	T/P SWITCH			

Bottom View

NOTE: This is engineering sample. The image above may not be exactly the same as the real main board you get.

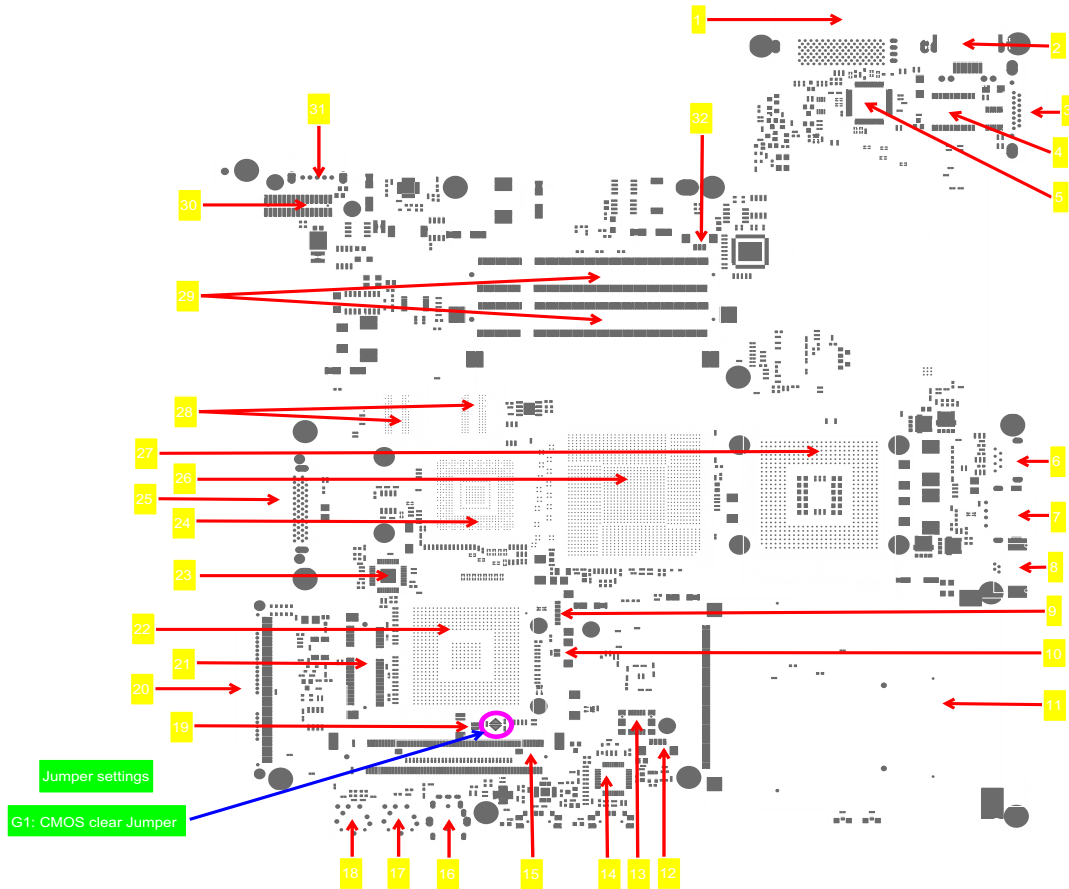

1	CN9	DOCKING	17	CN30	MIC CONN
2	CN8	RJ45 CONN	18	CN29	LINE-IN CONN
3	CN10	CRT CONN	19	CN25	RTC CONN
4	U21	LAN TRANSFORMER	20	CN22	HDD CONN
5	U20	SUPER I/O NS87383	21	CN21	MIMI CARD
6	CN15	S-VIDEO CONN	22	U35	South Bridge ICH7M
7	CN17	USB CONN	23	U34	DVO CHRONTEL-CH7307
8	CN18	1394 CONN	24	U30	NVIDIA-G72M
9	CN19	BLUETOOTH CONN	25	CN16	ODD CONN
10	CN20	INTERNAL MIC CONN	26	U31	NB 945GM/PM & 940GML
11	CN23	PCMCIA SLOT	27	U32	CPU-Yonah/Merom
12	CN7	INTERNAL SPEAKER CONN	28	U28-29	G72M-VRAM
13	CN24	MDC CONN	29	CN13-14	SODIMM CONN
14	U42	AUDIO CODEC ALLC883	30	CN11	POWER BOARD CONN
15	CN27	MIMI PCI CONN	31	PJ1	BATTERY CONN
16	CN28	HP OUT CONN	32	CN12	FAN CONN

Jumper Settings/Clear BIOS Password Procedures

1. Please see the bottom side of the main board.
2. Find G1 jumper and short the jumper to clear BIOS password.

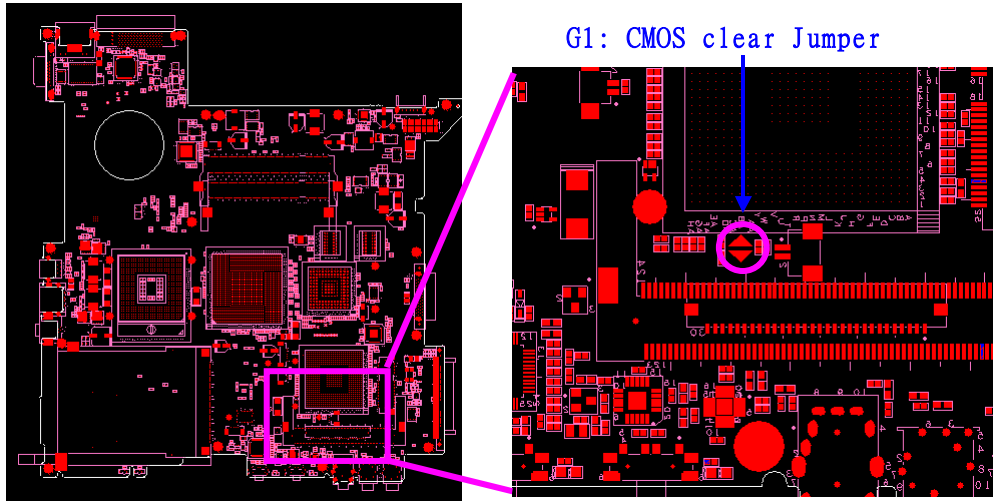

Your Acer Notebook tour

After knowing your computer features, let us show you around your new TravelMate computer.



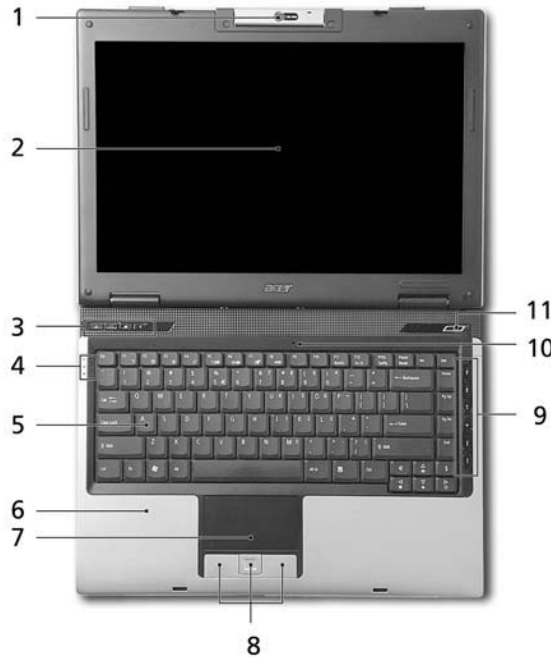



Front View

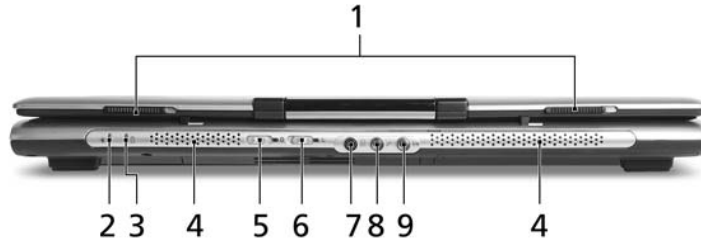

#	Icon	Item	Description
1		Built-in camera	1.3 megapixel/310,000 pixel web camera for video communication. (for selected models)
2		Display screen	Also called Liquid-Crystal Display (LCD), displays computer output.
3		Easy-launch buttons	Buttons for launching frequently used program.
4		Status indicators	Light-Emitting Diodes (LEDs) that light up to show the status of the computer's functions and components.
5		Keyboard	For entering data into your computer.
6		Palmrest	Comfortable support area for your hands when you use the computer.
7		Touchpad	Touch-sensitive pointing device which functions like a computer mouse.
8		Click buttons (left, center and right)	The left and right buttons function like the left and right mouse buttons; the center button serves as a 4-way scroll button.
9		Arcade/media/volume buttons	For use with Acer Arcade and other media playing programs (for selected models, yet Aspire 3680/557/5580 do not have Arcade/media/volume buttons).
10		Microphone	Internal microphone for sound recording.
11		Power button	Turns the computer on and off.







Closed Front View

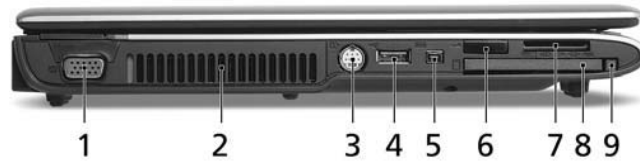

#	Icon	Item	Description
1		Latch	Locks and release the lid
2		Power indicator	Indicates the computer's power status.
3		Battery indicator	Indicates the computer's battery status.
4		Speakers	Left and right speakers deliver stereo audio output.
5		Bluetooth® communication switch/indicator	Press to enable/disable Bluetooth function. Lights to indicate the status of Bluetooth-communications (optional).
6		Wireless communication button/indicator	Press to enable/disable Wireless function. Lights to indicate the status of wireless LAN communications (optional).
7		Headphones/speakers/line-out jack with S/PDIF support	Connects to audio line-out devices (e.g., speakers, headphones).
8		Microphone-in jack	Accepts input from external microphones.
9		Line-in jack	Accepts audio line-in devices (e.g., audio CD player, stereo walkman).



Left View



#	Icon	Item	Description
1		External display (VGA) port	Connects to a display device (e.g., external monitor, LCD projector).
2		Ventilation slots	Enable the computer to stay cool, even after prolonged use.
3		S-Video/TV-out (NTSC/PAL) port	Connects to a television or display device with S-video input.
4		USB 2.0 port	Connects to USB 2.0 devices (e.g. USB mouse, USB camera).
5		4-pin IEEE 1394 port	Connects to IEEE 1394 devices (for selected models, yet Aspire 3680/5570/5580 do not have IEEE 1394 port)
6		Infrared port	Interfaces with infrared devices (e.g., infrared printer and IR-aware computer). (for selected models, yet Aspire 3680/5570/5580 do not have infrared port)
7		5-in-1 card reader	Accepts Memory Stick (MS), Memory Stick PRO (MS PRO), MultiMediaCard (MMC), Secure Digital (SD) and xD-Picture Card (xD). Note: Only one card can operate at any given time.
8		PC Card slot	Accepts one Type II PC Card.
9		PC Card slot eject button	Ejects the PC Card from the slot.



Right View

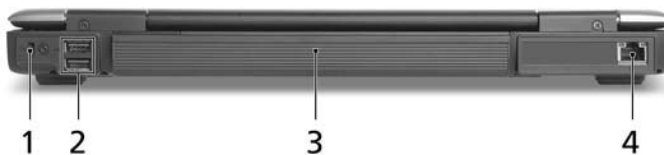

#	Icon	Item	Description
1		Optical drive	Internal optical drive; accepts CDs or DVDs (slot-load or tray-load depending on model).
2		Optical disk access indicator	Lights up when the optical drive is active (location depends on model).
3		Optical drive eject button	Ejects the optical disk from the drive (location depends on model).
4		Emergency eject hole	Ejects the optical drive tray when the computer is turned off (location depends on model).
5		Modem (RJ-11) port	Connects to a phone line.
6		DC-in jack	Connects to an AC adapter.

Rear Panel



#	Icon	Item	Description
1		Kensington lock slot	Connects to a Kensington-compatible computer security lock.
2		USB 2.0 ports	Connect to USB 2.0 devices (e.g., USB mouse, USB camera).
3		Battery	Powers the computer

#	Icon	Item	Description
4		Ethernet (RJ-45) port	Connects to an Ethernet 10/100-based network.

Bottom Panel

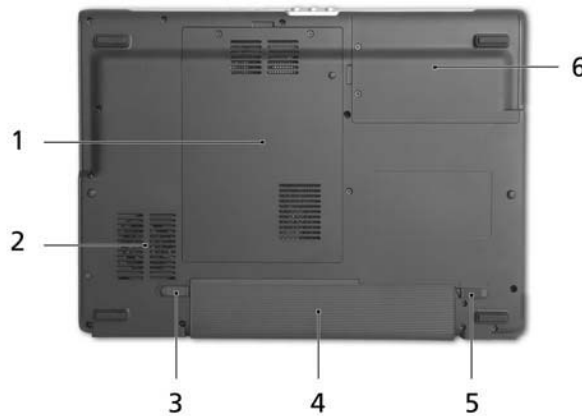







#	Item	Description
1	Memory compartment	Houses the computer's main memory.
2	Cooling fan	Helps keep the computer cool. Note: Do not cover or obstruct the opening of the fan.
3	Battery release latch	Release the battery for removal.
4	Battery bay	Houses the computer's battery pack.
5	Battery lock	Locks the battery in position.
6	Hard disk bay	Houses the computer's hard disk (secured with screws)

Indicators

The computer has four easy-to-read status indicators:



The front panel indicators are visible even when the computer cover is closed up.

Icon	Function	Description
	Cap lock	Lights when Cap Lock is activated
	Num lock	Lights when Num Lock is activated.
	HDD	Indicates when the hard disc or optical drive is active.
	Bluetooth	Indicates the status of Bluetooth communication.
	Wireless LAN	Indicates the status of wireless LAN communication.
	Power	Lights up when the computer is on.
	Battery	Lights up when the battery is being charged.



NOTE: 1. Charging: The light shows amber when the battery is charging. **2. Fully charged:** The light shows green when in AC mode.

Easy-Launch Buttons

Located above the keyboard are four buttons. These buttons are called easy-launch buttons. They are: mail Web browser, Empowering Key “*e*” and one user-programmable button.

Press “*e*” to run the Acer Empowering Technology. The mail and Web browser buttons are pre-set to email and Internet programs, but can be reset by users. To set the Web browser, mail and programmable buttons, run the Acer Launch Manager.



Launch key	Default application
<i>e</i>	Acer Empowering Technology (user-programmable)
	Email application (user-programmable)
	Internet browser (user-programmable)
P	User-programmable

Touchpad Basics

The following teaches you how to use the touchpad:

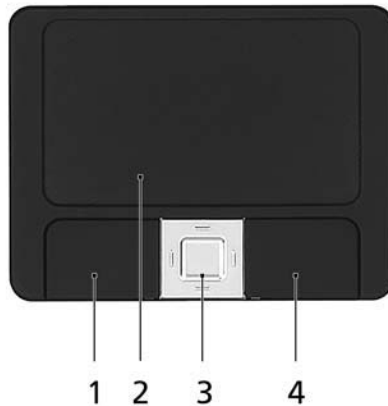

- Move your finger across the touchpad (2) to move the cursor.
- Press the left (1) and right (4) buttons located beneath the touchpad to perform selection and execution functions. These two buttons are similar to the left and right buttons on a mouse. Tapping on the touchpad is the same as clicking the left button.
- Use the 4-way scroll (3) button to scroll up or down and move left or right a page. This button mimics your cursor pressing on the right scroll bar of Windows applications.

Function	Left Button (1)	Right Button (4)	Main touchpad (2)	Center button (3)
Execute	Click twice quickly		Tap twice (at the same speed as double-clicking the mouse button)	
Select	Click once		Tap once	
Drag	Click and hold, then use finger to drag the cursor on the touchpad		Tap twice (at the same speed as double-clicking a mouse button) then hold finger to the touchpad on the second tap to drag the cursor.	
Access context menu		Click once		
Scroll				Click and hold to move up/down/left/right.

NOTE: When using the touchpad, keep it - and your fingers - dry and clean. The touchpad is sensitive to finger movement; hence, the lighter the touch, the better the response. Tapping too hard will not increase the touchpad's responsiveness.

NOTE: By default, vertical and horizontal scrolling is enabled on your touchpad. It can be disabled under Mouse settings in Windows Control Panel.

Using the Keyboard

The keyboard has full-sized keys and an embedded keypad, separate cursor keys, two Windows keys and twelve function keys.

Lock Keys and embedded numeric keypad

The keyboard has three lock keys which you can toggle on and off.











Lock Key	Description
Caps Lock	When Caps Lock is on, all alphabetic characters typed are in uppercase.
Num lock <Fn>+<F11>	When Num Lock is on, the embedded keypad is in numeric mode. The keys function as a calculator (complete with the arithmetic operators +, -, *, and /). Use this mode when you need to do a lot of numeric data entry. A better solution would be to connect an external keypad.
Scroll lock <Fn>+<F12>	When Scroll Lock is on, the screen moves one line up or down when you press the up or down arrow keys respectively. Scroll Lock does not work with some applications.

The embedded numeric keypad functions like a desktop numeric keypad. It is indicated by small characters located on the upper right corner of the keycaps. To simplify the keyboard legend, cursor-control key symbols are not printed on the keys.

Desired Access	Num Lock On	Num Lock Off
Number keys on embedded keypad	Type numbers in a normal manner.	
Cursor-control keys on embedded keypad	Hold <Shift> while using cursor-control keys.	Hold <Fn> while using cursor-control keys.
Main keyboard keys	Hold <Fn> while typing letters on embedded keypad.	Type the letters in a normal manner.

Windows Keys

The keyboard has two keys that perform Windows-specific functions.



Key	Icon	Description
Windows key 		<p>Pressed alone, this key has the same effect as clicking on the Windows Start button; it launches the Start menu. It can also be used with other keys to provide a variety of function:</p> <ul style="list-style-type: none">  + <Tab> Activates next taskbar button.  + <E> Opens the My Computer window  + <F1> Opens Help and Support.  + <F> Opens the Find: All Files dialog box.  + <R> Opens the Run dialog box.  + M Minimizes all windows. <p><Shift>+  + <M> Undoes the minimize all windows action.</p>
 Application key		This key has the same effect as clicking the right mouse button; it opens the application's context menu.













Hot Keys

The computer employs hotkeys or key combinations to access most of the computer's controls like screen brightness, volume output and the BIOS utility.

To activate hot keys, press and hold the <Fn> key before pressing the other key in the hotkey combination.



Hot Key	Icon	Function	Description
Fn-F1	?	Hot key help	Displays help on hot keys.
Fn-F2		Acer eSetting	Launches the Acer eSettings in Acer eManager.
Fn-F3		Acer ePowerManagement	Launches the Acer ePowerManagement in Acer eManager.

Hot Key	Icon	Function	Description
Fn-F4		Sleep	Puts the computer in Sleep mode.
Fn-F5		Display toggle	Switches display output between the display screen, external monitor (if connected) and both.
Fn-F6		Screen blank	Turns the display screen backlight off to save power. Press any key to return.
Fn-F7		Touchpad toggle	Turns the internal touchpad on and off.
Fn-F8		Speaker toggle	Turns the speakers on and off.
Fn- 		Volume up	Increases the speaker volume.
Fn- 		Volume down	Decreases the speaker volume.
Fn- 		Brightness up	Increases the screen brightness.
Fn- 		Brightness down	Decreases the screen brightness

Special Key

You can locate the Euro symbol and US dollar sign at the upper-center and/or bottom-right of your keyboard. To type:



The Euro symbol

1. Open a text editor or word processor.
2. Either directly press the **<Euro>** symbol at the bottom-right of the keyboard, or hold **<Alt Gr>** and then press the **<5>** symbol at the upper-center of the keyboard.

The US dollar sign

1. Open a text editor or word processor.
2. Either directly press the **<Dollar>** key at the bottom-right of the keyboard, or hold **<Shift>** and then press the **<4>** key at the upper-center of the keyboard.

NOTE: This function varies by the operating system version.

NOTE: Some fonts and software do not support the Euro symbol. Please refer to www.microsoft.com/typography/faq/faq12.htm for more information.

Acer Empowering Technology

Acer's innovative Empowering Technology makes it easy for you to access frequently used functions and manage your new Acer notebook. It features the following handy utilities:

- ❑ **Acer eNet Management (for selected models)** hooks up to location-based networks intelligently.
- ❑ **Acer ePower Management** extends battery power via versatile usage profiles.
- ❑ **Acer ePresentation Management** connects to a projector and adjusts display settings conveniently.
- ❑ **Acer eDataSecurity Management (for selected models)** protects data with passwords and advanced encryption algorithms.
- ❑ **Acer eLock Management (for selected models)** limits access to external storage media.
- ❑ **Acer eRecovery Management** backs up and recovers data flexibly, reliably and completely.
- ❑ **Acer eSettings Management** accesses system information and adjusts settings easily.
- ❑ **Acer ePerformance Management** improves system performance by optimizing disk space, memory and registry settings.



For more information, press the < *e* > key to launch the Empowering Technology menu, then click on the appropriate utility and select the Help or Tutorial function.

Empowering Technology password

Before using Acer eLock Management and Acer eRecovery Management, you must initialize the Empowering Technology password. Right-click on the Empowering Technology toolbar and select "Password Setup" to do so. If you do not initialize the Empowering Technology password, you will be prompted to do so when running Acer eLock Management or Acer eRecovery Management for the first time.

Acer eNet Management (for selected models)

Acer eNet Management helps you to quickly and easily connect to both wired and wireless networks in a variety of locations. To access this utility, either click on the "Acer eNet Management" icon on your netebook, or start the program from the Start menu. You also have the option to set Acer eNet Management to start automatically when you boot up your PC.

Acer eNet Management automatically detects the best settings for a new location, while offering you the freedom to manually adjust the settings to match your needs.

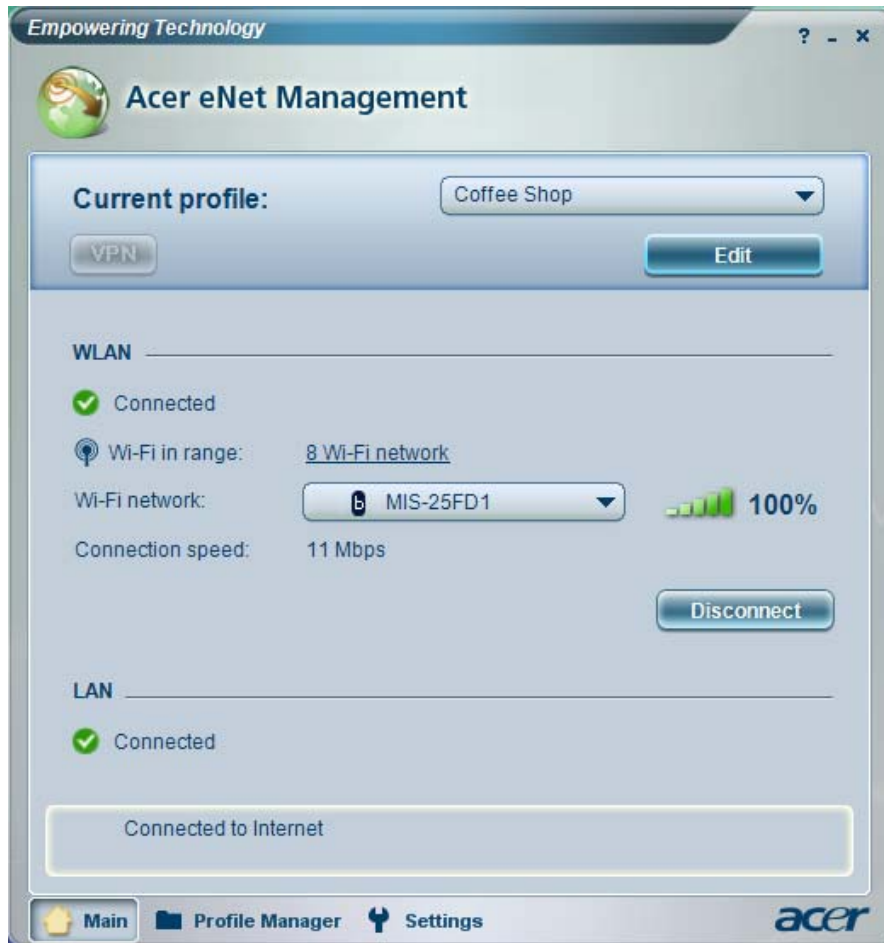

Acer eNet Management can save network settings for a location to a profile, and automatically switch to the appropriate profile when you move from one location to another. Settings stored include network connection settings (IP and DNS settings, wireless AP details, etc.), as well as default printer settings.

Security and safety concerns mean that Acer eNet Management does not store username and password information.

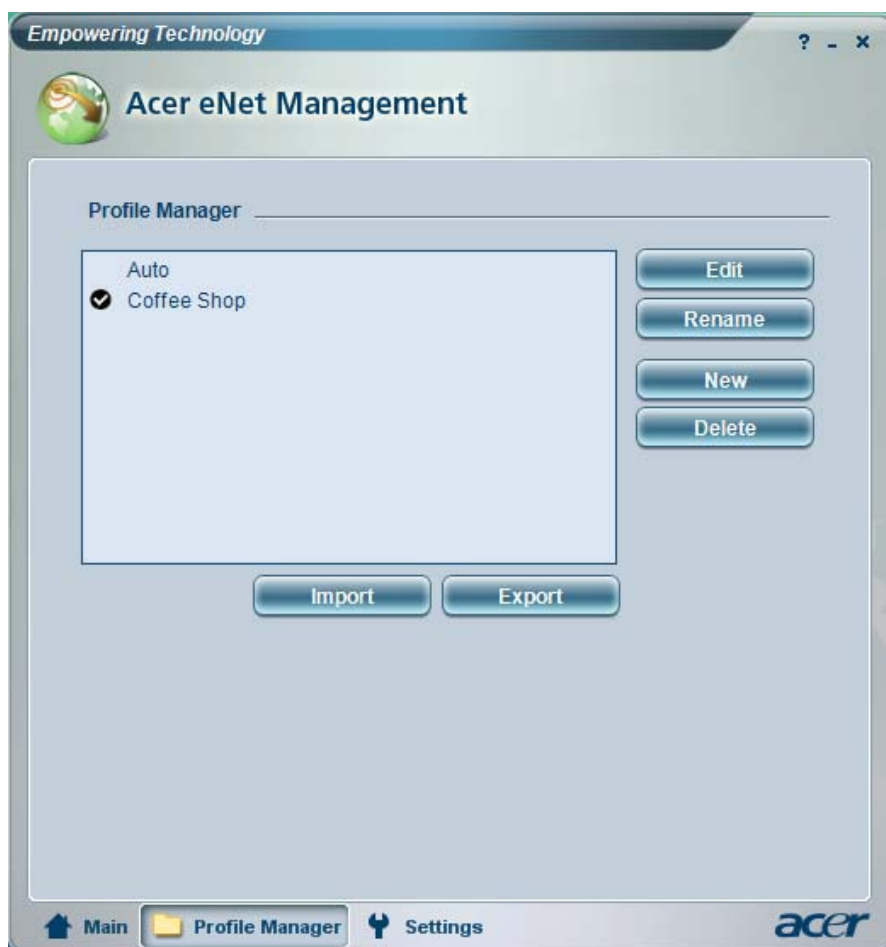

Acer ePower Management

Acer ePower Management features a straightforward user interface. To launch it, select Acer ePower Management from the Empowering Technology interface.

AC Mode (Adapter mode)

The default setting is “Maximum Performance.” You can adjust CPU speed, LCD brightness and other settings, or click on buttons to turn the following functions on/off: Wireless LAN, Bluetooth, CardBus, FireWire (1394), Wired LAN and Optical Device if supported.

DC Mode (Battery mode)

There are four pre-defined profiles - Entertainment, Presentation, Word Processing, and Battery Life. You can also define up to three of your own.

To create new power profile

1. Change power settings as desired.
2. Click “Save as...” to save to a new power profile.
3. Name the newly created profile.
4. Select whether this profile is for Adapter or Battery mode, then click OK.
5. The new profile will appear in the profile list.

Battery status

For real-time battery life estimates based on current usage, refer to the panel on the lower left-hand side of the window.



For additional options, click **“Settings”** to:

- Set alarms.
- Re-load factory defaults.
- Select what actions will be taken when the cover is closed or the power button is pressed.
- View information about Acer ePower Management.

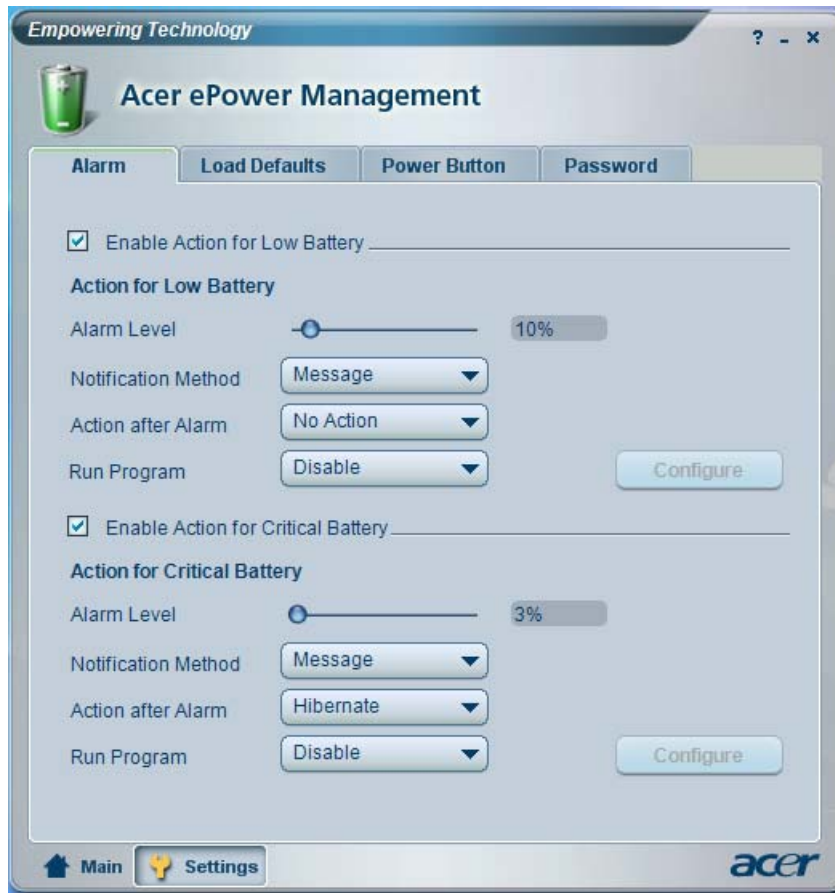

Acer ePresentation Management

Acer ePresentation Management lets you project your computer's display to an external device or project using the hot key: Fn + F5. If auto-detection hardware is implemented in the system, your system display will be automatically switched out when an external display is connected to the system.



Acer eDataSecurity Management (for selected models)

Acer eDataSecurity Management is handy file encryption utility that protects your files from being accessed by unauthorized persons. It is conveniently integrated with Windows explorer as a shell extension for quick and easy data encryption/decryption and also supports on-the-fly file encryption for MSN Messenger and Microsoft Outlook.

The Acer eDataSecurity Management setup wizard will prompt you for a supervisor password and default encryption. This encryption will be used to encrypt files by default, or you can choose to enter your own file-specific password when encrypting a file.

NOTE: The password used to encrypt a file is the unique key that the system needs to decrypt it. If you lose the password, the supervisor password is the only other key capable of decrypting the file. If you lose both passwords, there will be no way to decrypt your encrypted file! **Be sure to safeguard all related passwords!**

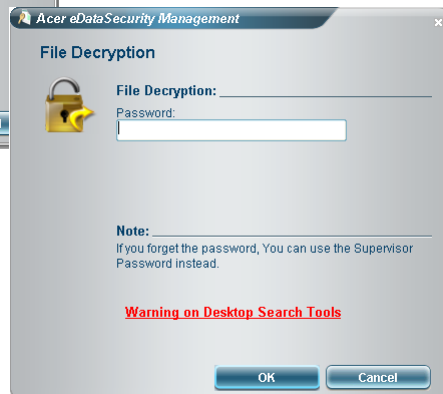
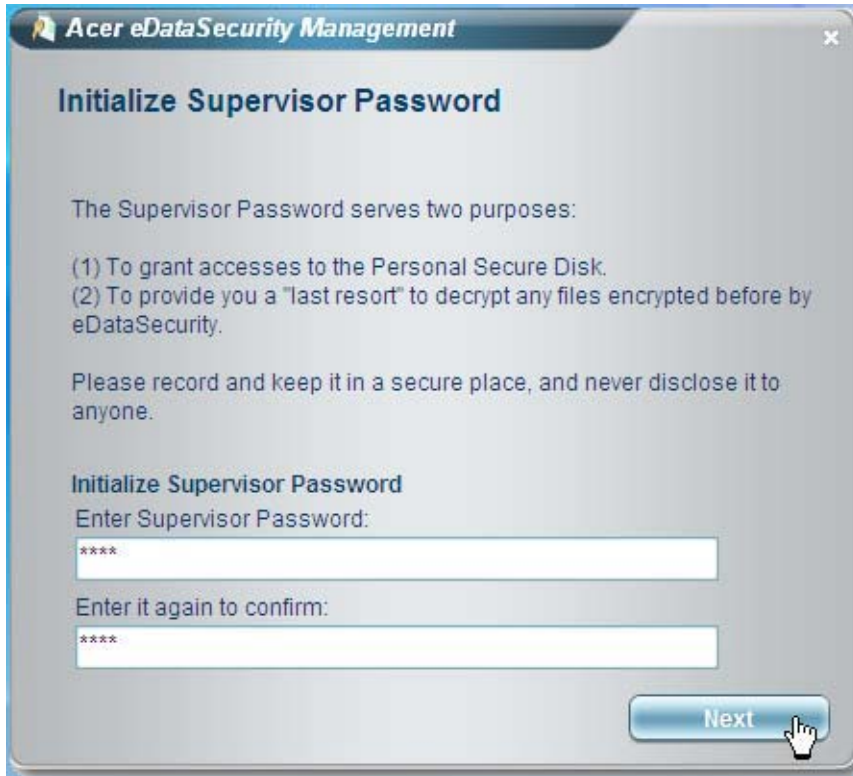

Acer eLock Management

Acer eLock Management is a security utility that allows you to lock your removable data, optical and floppy drives to ensure that data can't be stolen while your notebook is unattended.

- Removable data devices - includes USB disk drives, USB pen drives, USB flash drives, USB MP3 drives, USB memory card readers, IEEE 1394 disk drives and any other removable disk drives that can be mounted as a file system when plugged into the system.
- Optical drive devices - includes any kind of CD-ROM or DVD-ROM drives.
- Floppy disk drives - 3.5-inch disks only.
- Interfaces - includes serial ports, parallel port, infrared (IR), and Bluetooth.

To activate Acer eLock Management, a password must be set first. Once set, you can apply locks to any of the devices. Lock(s) will immediately be set without any reboot necessary, and will remain locked after rebooting, until unlocked.

NOTE: If you lose your password, there is no method to reset it except by reformatting your notebook or taking your notebook to an Acer Customer Service Center. Be sure to remember or write down your password.

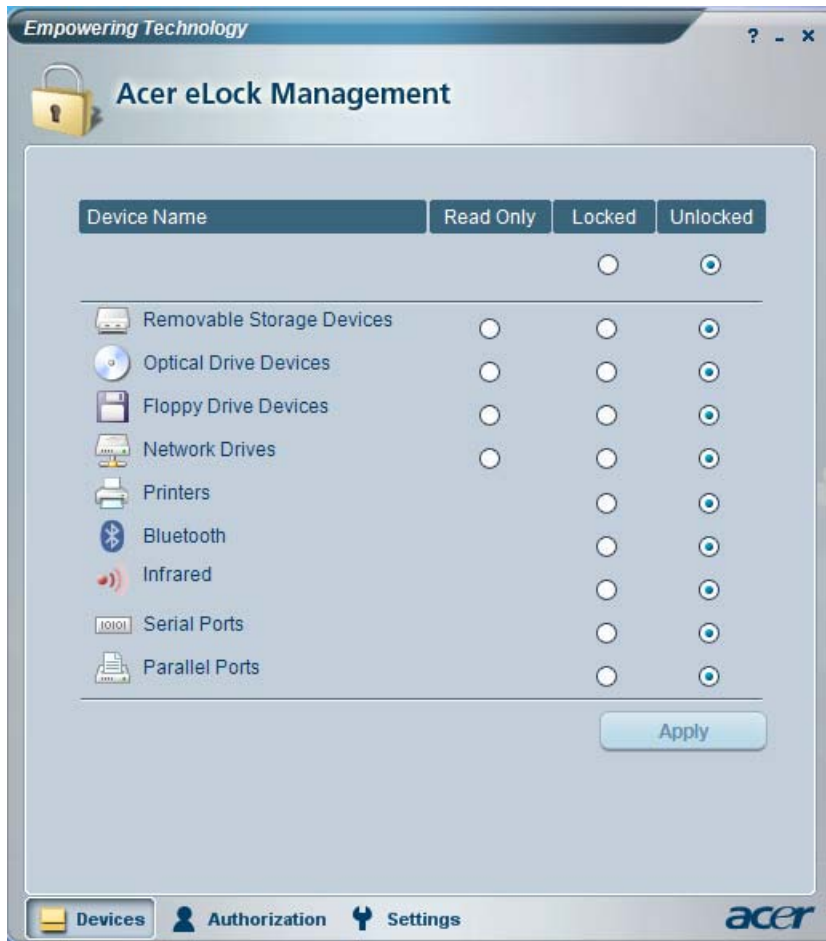

Acer eRecovery Management

Acer eRecovery Management is a powerful utility that does away with the need for recovery disks provided by the manufacturer. The Acer eRecovery Management utility occupies space in a hidden partition on your system's HDD. User-created backups are stored on D:\ drive. Acer eRecovery Management provides you with:

- Password protection.
- Recovery of applications and drivers.
- Image/data backup:
 - Back up to HDD (set recovery point).
 - Back up to CD/DVD.
- Image/data recovery tools:
 - Recover from a hidden partition (factory defaults).
 - Recover from the HDD (most recent user-defined recovery point).
 - Recover from CD/DVD.

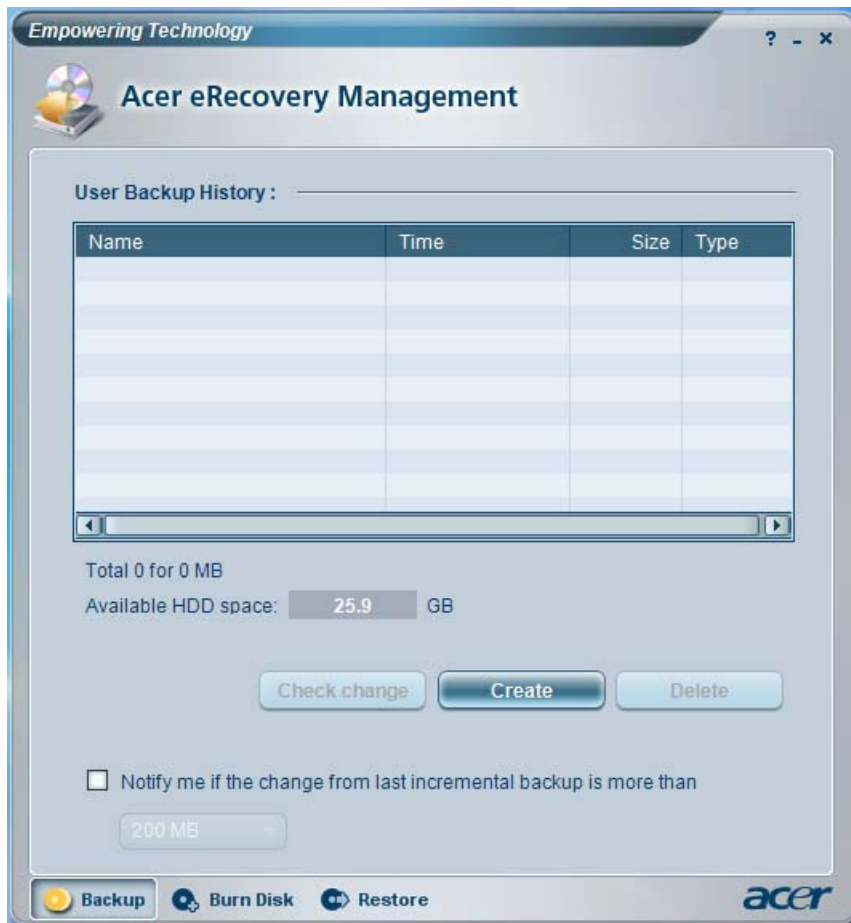

For more information, please refer to “Acer eRecovery Management”

NOTE: If your computer did not come with a Recovery CD or System CD, please use Acer eRecovery Management’s “System backup to optical disk” feature to burn a backup image to CD or DVD. To ensure the best results when recovering your system using a CD or Acer eRecovery Management, detach all peripherals (except the external Acer ODD, if your computer has one), including your Acer ezDock.

Acer eSettings Management

Acer eSettings Management allows you to inspect hardware specifications and to monitor the system health status. Furthermore, Acer eSettings Management enables you to optimize your Windows operating system, so your computer runs faster, smoother and better.

Acer eSettings Management also:

- Provides a simple graphical user interface for navigating.
- Displays general system status and advanced monitoring for power users.



Acer ePerformance Management

Acer ePerformance Management is a system optimization tool that boosts the performance of your Acer notebook. It provides an express optimization method to release unused memory and disk space quickly. The user can also enable advanced options for full control over the following option:

- Memory optimization - releases unused memory and check usage.
- Disk optimization - removes unneeded items and files.
- Speed optimization - improves the usability and performance of your Windows XP system.

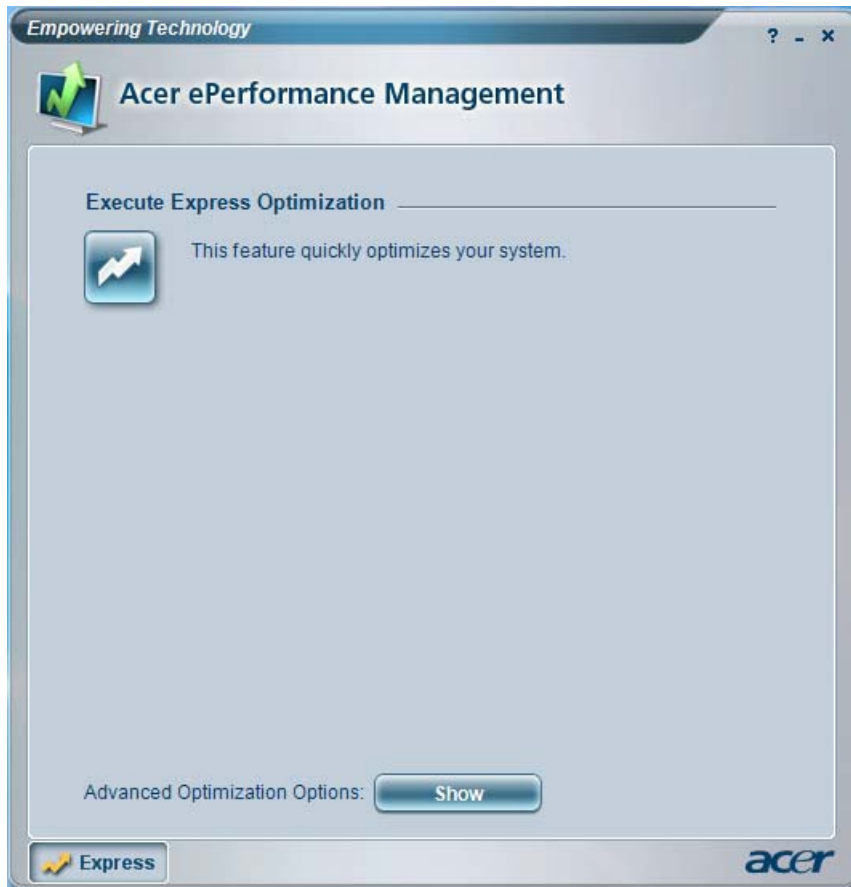

Acer OrbiCam

The Acer OrbiCam is a 1.3 megapixel CMOS camera appropriately mounted on the top of the LCD panel. The camera's 225-degree ergonomic rotation allows you to capture high-resolution photos or videos up front or at the back of the LCD panel. The Acer OrbiCam fully supports the Acer Video Conference technology so that you can transmit the best video quality over an instant Messenger service.

Getting to know your Acer OrbiCam

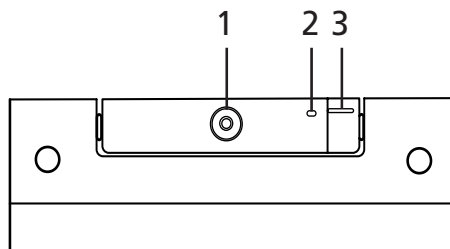

No.	Item
1	Lens
2	Power indicator

No.	Item
3	Rubber grip (selected models only)

Rotating the Acer Orbicam

The Acer Orbicam rotates 225 degrees counterclockwise to achieve the desired angle. Refer to the illustrations below:

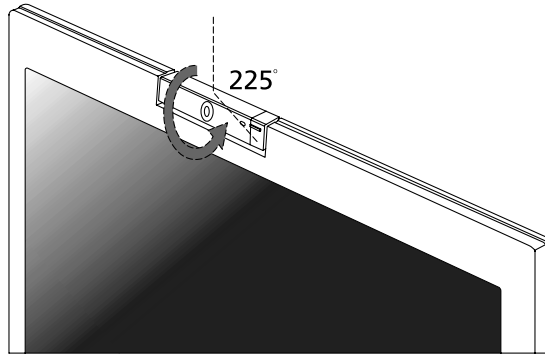

For your convenience, the camera snaps 45 degrees to match the position of your face in front or at the back of the LCD panel.

NOTE: Do not rotate the camera clockwise to prevent damage to the device.

Launching the Acer Orbicam

To launch the Acer Orbicam, double click on the Acer Orbicam icon on the screen.

OR

Click Start > All programs > Acer > Acer Orbicam. The Acer Orbicam capture windows window appears.

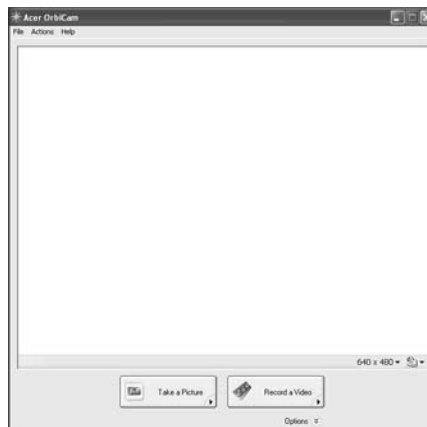

Changing the Acer Orbicam settings

Resolution

To change the capture resolution, click the displayed resolution at the bottom right corner of the capture window, then select the desired resolution.

Options

Click Options to display the Window, Preview, and Folder tabs. Use the options to change the capture window size, preview settings, and the folder for captured photos or videos.

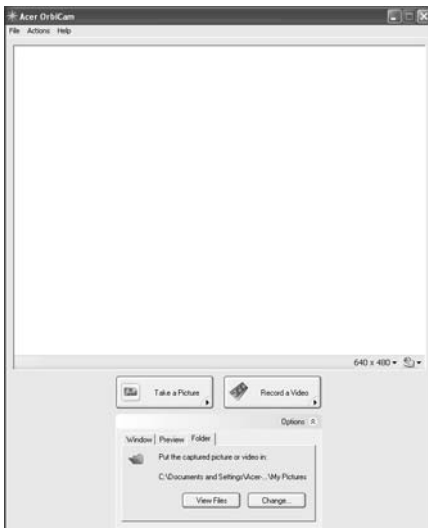

Camera Settings

- ❑ Basic settings: Click the Camera Settings icon on the bottom right corner of the capture display, then select Camera Settings from the pop-up menu. You can adjust the Video, Audio, and Zoom/Face tracking options from this window.



- ❑ Capture settings: From the Camera Settings window, click the Driver Settings button. The Properties window will appear.



-
- ❑ Device Settings allows you to change the camera brightness, contrast, hue, saturation, sharpness, etc.
 - ❑ Advanced Settings allows you to achieve gain control, implement image mirror, select image enhancements and anti-flicker settings, and turn on/off the camera indicator.
 - ❑ Zoom/Face Track Settings allows you to adjust the zoom level and turn the face tracking feature on or off.

Capturing photos or videos

To capture a photo or a video clip, rotate the Acer OrbiCam to get the desired angle, then click the Take a Picture or Record a Video button. The Windows Picture and Fax Viewer or the Windows Media Player automatically launches to display or play a preview of the photo/video clip.

NOTE: By default, all photos and videos are saved in the My Pictures and My Videos folder.

Using the Acer OrbiCam as webcam

The Acer OrbiCam is automatically selected as the capture device of any instant messenger (IM) application. To use the Acer OrbiCam as a webcam, open the IM service, then select the video/webcam feature. You can now broadcast from your location to an IM partner anywhere in the world.

Using the System Utilities

NOTE: The system utilities work under Microsoft Windows XP only.

Acer GridVista (dual-display compatible)

NOTE: This feature is only available on certain models.

To enable the dual monitor feature of the notebook, first ensure that the second monitor is connected, then select **Start, Control Panel, Display** and click on **Settings**. Select the secondary monitor (**2**) icon in the display box and then click the check box **Extend my windows desktop onto this monitor**. Finally, click **Apply** to confirm the new settings and click **OK** to complete the process.

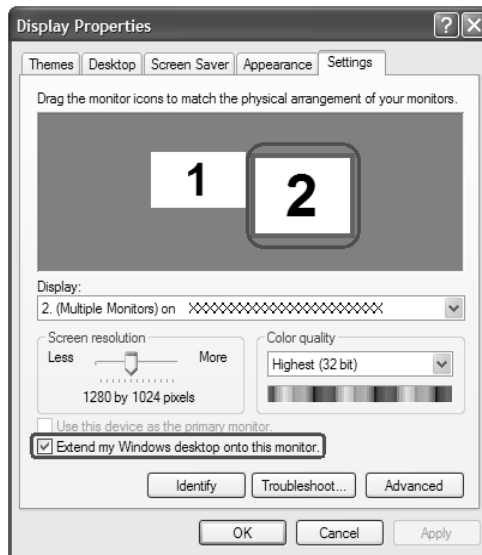

Acer GridVista is a handy utility that offers four pre-defined display settings so you can view multiple windows on the same screen. To access this function, please go to **Start>All Programs** and click on **Acer GridVista**. You may choose any one of the four display settings indicated below:



Double (verticle), Triple (primary at left), Triple (primary at right), or Quad Acer Gridvista is dual-display compatible, allowing two displays to be partitioned independently.

Acer Gridvista is dual-display compatible, allowing two displays to be partitioned independently.

AcerGridVista is imple to set up:

1. Run Acer GridVista and select your preferred screen configuration for each display from the task bar.
2. Drag and drop each window into the appropriate grid.
3. Enjoy the convenience of a well-organized desktop.

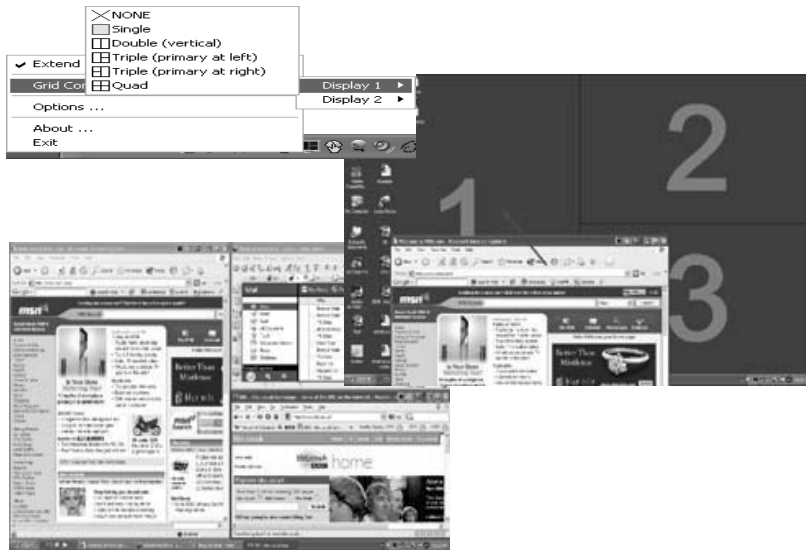

NOTE: Please ensure that the resolution setting of the second monitor is set to the manufacturer's recommended value.

Launch Manager

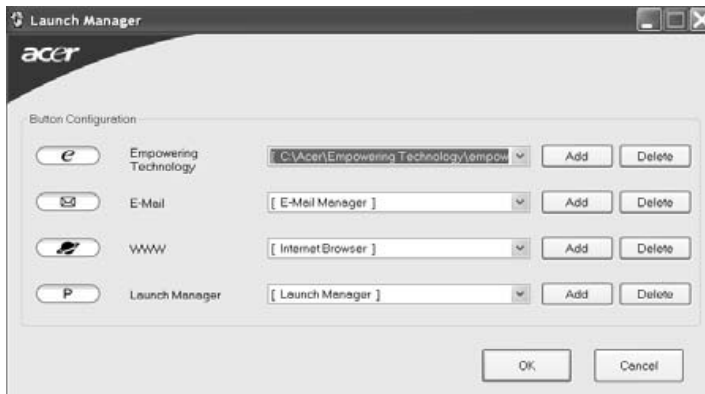

Launch Manager allows you to set the four easy-launch buttons located above the keyboard. You can access the Launch Manager by clicking on Start > All Programs > Launch Manager to start the application.

Hardware Specifications and Configurations

Processor

Item	Specification
CPU type	Intel® Core 2 Duo processor T5500/T5600 (2MB L2 cache, 1.66/1.83 GHz, 667 MHz FSB) and T7200/T7400/T7600 (4 MB L2 cache, 2/2.16/2.33 GHz, 667 MHz FSB) (for Aspire 5580) Intel® Core Duo processor T2300/T2400/T2500/T2600 (2MB L2 cache, 1.66/1.83/2/2.16 GHz, 667 MHz FSB) (for Aspire 5570) Intel® Celeron M processor 410/420/430 (1 MB L2 cache, 1.46/1.60/1.73 GHz, 533 MHz FSB) or higher (for Aspire 3680)
Core logic	Intel® 945GM/945PM/940GML(Aspire 3680)+ICH7M
CPU package	Intel 478pin Micro-FCPGA
CPU core voltage	VCC-CORE: 1.2875V (high frequency mode) to 0.8375V (Low frequency mode) VCC-CORE: 0.75V (Deeper sleep mode) VCC_CORE: voltage for the future processor will depend on VID0-6 for battery mode and setting via software for adapter mode for the future processor

CPU Fan True Value Table

DTS(degree C)	Fan Speed (rpm)	Acoustic Level (dBA)
45	0	29
50	2700+/-100	32
70	3200+/-100	35
78	3800+/-100	38
90	4200+/-100	40

BIOS

Item	Specification
BIOS vendor	Phneoix
BIOS Version	1.00 (MP version)
BIOS ROM type	SST/AMD 1MB CMOS Boot Block Flash Memory
BIOS ROM size	1M byte FLASH ROM SST
BIOS package	32-pin PLCC
Supported protocols	ACPI 1.0b/2.0/3.0 compliance, PCI 2.2, System/HDD Password Security Control, INT 13H Extensions, PnP BIOS 1.0a SMBIOS 2.4, BIOS Boot Specification, Simple Boot Flag 1.0, Boot Block, PCI Bus Power Management Interface Specification, USB Specification 1.1/2.0, IEEE 1394 1.0, USB/1394 CD-ROM Boot Up support, PC Card Standard 1995 (PCMCIA 3.0 Compliant Device), IrDA 1.0, Intel AC97 CNR Specification, WfM 2.0, PXE 2.1, Boot Integrity Service Application Program Interface (BIS) 1.0, PC99a and Mobile PC2001 Compliant
BIOS password control	Set by setup manual

Second Level Cache

Item	Specification
Cache controller	Built-in CPU

Second Level Cache

Item	Specification
Cache size	4MB for Intel® Core 2 Duo processor T7200/T7400/T7600 (Aspire 5580) 2MB for Intel® Core 2 Duo processor T5500/T5600 and Intel® Core Duo processor T2300/T2400/T2500/T2600 (Aspire 5580/5570) 1MB for Intel® Celeron M processor 410/420/430 (Aspire 3680)
1st level cache control	Always enabled
2st level cache control	Always enabled
Cache scheme control	Fixed in write-back

System Memory

Item	Specification
Memory controller	Built-in Intel® 945GM/945PM/940GML
Memory size	0MB (no on-board memory)
DIMM socket number	2 sockets
Supports memory size per socket	1024MB
Supports maximum memory size	Maximum memory up to 2GB for 32bit OS (with two 1GB SODIMM), 4G for 64bit OS(with two 2GB SODIMM)
Supports DIMM type	DDR 2 Synchronous DRAM
Supports DIMM Speed	533/677 MHz
Supports DIMM voltage	1.8V and 0.9V
Supports DIMM package	200-pin soDIMM
Memory module combinations	You can install memory modules in any combinations as long as they match the above specifications.

Memory Combinations

Slot 1	Slot 2	Total Memory
0MB	256MB	256MB
0MB	512MB	512MB
0MB	1024MB	1024MB
0MB	2048MB	2048MB
256MB	256MB	512MB
256MB	512MB	768MB
256MB	1024MB	1280MB
256MB	2048MB	2304MB
512MB	256MB	768MB
512MB	512MB	1024MB
512MB	1024MB	1536MB
512MB	2048MB	2560MB
1024MB	0MB	1024MB
1024MB	256MB	1280MB
1024MB	512MB	1536MB
1024MB	1024MB	2048MB
1024MB	2048MB	3072MB
2048MB	0MB	2048MB
2048MB	256MB	2304MB
2048MB	512MB	2560MB
2048MB	1024MB	3072MB
2048MB	2048MB	4096MB

NOTE: Above table lists some system memory configurations. You may combine DIMMs with various capacities to form other combinations. On above table, the configuration of slot 1 and slot 2 could be reversed.

LAN Interface

Item	Specification
Chipset	Marvell 88E8030/88E8055 co-lay
Supports LAN protocol	10/100Mbps (Giga LAN support for future selected models)
LAN connector type	RJ45
LAN connector location	Rear side
Features	Integrated 10/100 BASE-T transceiver Wake on LAN support compliant with ACPI 2.0 PCI v2.2

Modem Interface

Item	Specification
Data modem data baud rate (bps)	56K
Supports modem protocol	V.90/V.92 WWVDA
Modem connector type	RJ11
Modem connector location	Right side

Bluetooth Interface

Item	Specification
Chipset	Built-in ICH7M
Data throughput	723 bps (full speed data rate)
Protocol	Bluetooth 1.1 (Upgradeable to Bluetooth 1.2 when SIG specification is ratified).
Interface	USB 1.1
Connector type	Mini-USB

Wireless Module 802.11a/b/g (optional device)

Item	Specification
Chipset	Built-in ICH7M
Data throughput	11~54 Mbps
Protocol	802.11a+b+g or 802.11b+g
Interface	PCI bus

Hard Disk Drive Interface

Item					
Vendor & Model Name	HGST HTS421240H9A	WD WD600UE-22HCT0 HGST HTS541060G9A	SEAGATE ST98823A	HGST MORAGA+ HTS541010G9A Seagate ST9100824A	HGST HTS541612J9AT WD1200UE-22KV0 ML60
Capacity (MB)	40000	60000	80000	100000	120000
Bytes per sector	512	512	512	512	512
Data heads	2	2	3	4	4
Drive Format					
Disks	1	1	2	2	2 for WD
Spindle speed (RPM)	4200 RPM	5400 RPM	5400 RPM	5400 RPM	5400 RPM
Performance Specifications					
Buffer size	8MB	2MB for WD 8MB for HGST	8MB	8192KB	8192KB
Interface	ATA/ATAPI-7	ATA-6 for WD ATA/ATAPI-7 for HGST	ATA/ATA-6; ATA-6	ATA/ATAPI-6	ATA-6 for WD
Max. media transfer rate (disk-buffer, Mbytes/s)	376	350 (for WD) 376 (for HGST)	350	493	540 for HGST
Data transfer rate (host-buffer, Mbytes/s)	100 MB/Sec. Ultra DMA mode-5	100 MB/Sec. Ultra DMA mode-5	100 MB/Sec. Ultra DMA mode-5	100 MB/Sec. Ultra DMA mode-5	100 MB/Sec. Ultra DMA mode-5
DC Power Requirements					
Voltage tolerance	5V(DC) +/- 5%	5V(DC) +/- 5%	5V(DC) +/- 5%	5V(DC) +/- 5%	5V(DC) +/- 5%

Combo Drive Interface

Item	Specification	
Vendor & model name	HLDS GCC-4244N Philips SCB5265 Panasonic UJDA770	
Performance Specification	With CD Diskette	With DVD Diskette
Transfer rate (KB/sec)	Sustained: Max 3.6Mbytes/sec	Sustained: Max 10.8Mbytes/sec
Buffer Memory	2MB	
Interface	Enhanced IDE(ATAPI) compatible	
Applicable disc format	<p>For HDLS GCC-4244N:</p> <ol style="list-style-type: none"> 1. Reads and writes data in each CD-ROM, CD-ROMXA, CD-I FMV, Video CD and CD-EXTRA 2. Reads data in Photo CD (Single and multi session) 3. Reads and writes standard CD-DA 4. Reads and writes CD-R discs conforming to "Orange Book Part 2" 5. Reads and writes CD-RW discs conforming to "Orange Book Part 3" 6. Reads data in DVD-ROM <p>For Philips SB5265:</p> <p>Applicable DVD formats (Read): DVD: DVD-ROM, (DVD-5, DVD-9, DVD-10, DVD-18), DVD-Video, DVD-R 3.95G, DVD-R 4.7G, DVD-RW, DVD+R, DVD+RW, Multi-Border DVD-R/DVD-RW, Multi-session DVD+R, DVD+RW and DVD-RAM (optional)</p> <p>Applicable CD Formats (Read): CD: CD-DA, CD-ROM Mode-1, CD-ROM/XA Mode Mode-2 Form-1 and Mode-2 Form-2, CD-i Ready, Video-CD (MPEG-1), Karaoke CD, Super Video CD, Photo-CD, Enhanced CD, CD Plus, CD Extra, i-trax CD, CD-Text, CD-R, CD-RW</p> <p>Applicable CD Formats (Write) CD-DA, CD-ROM Mode-1, CD-ROM/XA Mode-2 Form-1 and Mode-2 Form-2, CD-i, Video-CD CD-Text</p> <p>For Panasonic UJDA770:</p> <p>CD: CD-DA, CD-ROM, CD-R, CD-RW, CD-ROM XA, Photo CD (Multi session), Video CD, CD-Extra (CD+), CD-text</p> <p>DVD: DVD-ROM, DVD-Video, DVD-RAM (2.6GB/4.7GB), DVD-R, DVD-RW (ver. 1.1) (Supporting Multi Border) DVD+R, DVD+RW (Supporting Multi Session)</p>	
Loading mechanism	Load: Manual Release: (a) Electrical Release (Release Button) (b) Release by ATAPI command (c) Emergency Release	
Power Requirement		
Input Voltage	5 V +/- 5 % (Operating)	

DVD-Super Multi Interface

Item	Specification	
Vendor & model name	PANASONIC UJ-850 , LF, GBASE TOSHIBA TSSTTS-L632D	
Performance Specification	With CD Diskette	With DVD Diskette
Transfer rate (KB/sec)	Sustained: Max 3.6Mbytes/sec	Sustained: Max 10.08Mbytes/sec
Buffer Memory	2MB	
Interface	Enhanced IDE(ATAPI) compatible	

DVD-Super Multi Interface

Item	Specification
Applicable disc format	<p>For PANASONIC UJ-850: Applicable disc format CD: CD-DA, CD-ROM, CD-ROM XA, PhotoCD (multi-session), Video CD, Cd-Extra (CD+), CD-text DVD: DVD-VIDEO, DVD-ROM, DVD-R (3.9GB, 4.7GB) DVD-R DL, DVD-RW, DVD-RAM, DVD+R, DVD+R DL, DVD+RW</p> <p>For Toshiba TSST TS-L632D CD: CD-DA (Red Book) - Standard Audio CD & CD-TEXT CD-ROM (Yellow Book Mode1 & 2) - Standard Data CD-ROM XA (Mode2 Form1 & 2) - Photo CD, Multi-Session CD-I (Green Book, Mode2 Form1 & 2, Ready, Bridge) CD-Extra/ CD-Plus (Blue Book) - Audio & Text/Video Video-CD (White Book) - MPEG1 Video CD-R (Orange Book Part) CD-RW & HSRW (Orange Book Part Volume1 & Volume 2 Super Audio CD (SACD) Hybrid type US & US+ RW</p> <p>DVD: DVD-ROM (Book 1.02), DVD-Dual DVD-Video (Book 1.1) DVD-R (Book 1.0, 3.9G) DVD-R (Book 2.0, 4.7G) - General & Authoring DVD+R (Version 1.0) DVD+RW DVD-RW (Non CPRM & CPRM) DVD[™]R Dual</p>
Loading mechanism	Load: Manual Release: (a) Electrical Release (Release Button) (b) Release by ATAPI command (c) Emergency Release
Power Requirement	
Input Voltage	5 V +/- 5 % (Operating)

Audio Interface

Item	Specification
Audio Controller	Realtek ALC883D Azalia and Amplifier Maxim MAX9710 & MAZ4411
Audio onboard or optional	Built-in
Mono or Stereo	Stereo
Resolution	18 bit stereo full duplex
Compatibility	HD audio Interface; S/PDIF output for PCM or AC-3 content
Sampling rate	1Hz resolution VSR (Variable Sampling Rate)
Internal microphone	Yes
Internal speaker / Quantity	Yes/2 (1.5W speakers)

Video Interface

Item	Specification
Chipset	Intel [®] 945GM (for Aspire 5570/5580 UMA models) and Intel [®] 940GML (Aspire 3680) Nvidia G7300 (G72M-V) (for Aspire 5570/5580 discrete models)

Video Interface

Item	Specification
Package	FCBGA 1466-pin for Intel® 945GM and Intel® 940GML BGA 533 pin for Nvidia G7300
Interface	internal PCIE
Supports ZV (Zoomed Video) port	Yes

Video Memory

Item	Specification
Chipset	Intel® 945GM (for Aspire 5570/5580 UMA models) and Intel® 940GML (Aspire 3680) Nvidia G7300 (G72M-V) (for Aspire 5570/5580 discrete models)
Memory size	up to 128MB
Interface	DDR2

USB Port

Item	Specification
Chipset	Built-in ICH7M
USB Compliancy Level	2.0
OHCI	USB 1.1 and USB 2.0 Host controller
Number of USB port	3
Location	One on the left side/two on the rear side
Serial port function control	Enable/Disable by BIOS Setup

PCMCIA Port

Item	Specification
PCMCIA controller	TI PCI8412/PCI6412
Supports card type	Type-II
Number of slots	One type-II
Access location	Left panel
Supports ZV (Zoomed Video) port	No ZV support
Supports 32 bit CardBus	Yes

System Board Major Chips

Item	Controller
Core logic	Intel® 945GM/945PM/940GML+ICH7M
VGA	Intel® 945GM (for Aspire 5570/5580 UMA models) and Intel® 940GML (Aspire 3680) Nvidia G7300 (G72M-V) (for Aspire 5570/5580 discrete models)
LAN	Marvell 88E8055 for GigaLAN for future advanced models, not launch yet Marvell 88E8038 for 10/100 LAN
USB 2.0	Built in ICH7M
Super I/O controller	NS PC87383
MODEM	ALC 883
Bluetooth	Built-in ICH7M

System Board Major Chips

Item	Controller
Wireless 802.11 b/g/Wireless 802.11 a+b/g	Built-in ICH7M
PCMCIA/1394/ 5 in 1 Card Reader	TI PCI8412/PCI16412
Audio Codec	Realtek ALC883

Keyboard

Item	Specification
Keyboard controller	NS PC87541V
Total number of keypads	88-/89-key
Windows logo key	Yes
Internal & external keyboard work simultaneously	Plug USB keyboard to the USB port directly: Yes

Battery

Item	Specification
Vendor & model name	Panasonic (6cell) 2.0 Sanyo (6cell) 2.0 Sony (6cell) 2.0 Sanyo (9cell) 2.4
Battery Type	Li-ion
Pack capacity	4000 mAH for Panasonic (6cell) 2.0 4000 mAH Sanyo (6cell) 2.0 4000 mAH Sony (6cell) 2.0 7200 mAH Sanyo (9cell) 2.4
Number of battery cell	6/9
Package configuration	3 cells in series, 2 series in parallel 3 cells in series, 3 series in parallel
Normal voltage	14.8V
Charge voltage	16.8+-0.2v

LCD 14.1" inch

Item	Specification		
Vendor & model name	QDI QD14TL01-03 (Non Glare) QDI QD14TL01-02 (Glare)	CMO N14111-L02 (Non Glare) CMO N14111-L03 (Glare)	LG LPL LP141WX1-TLA1 (Non Glare) LG LPL LP141WX1-TLA2 (Glare)
Screen Diagonal (mm)	14.1 inches	14.1 inches	14.1 inches
Active Area (mm)	304.1x228.1	304.1x228.1	304.1x228.1
Display resolution (pixels)	1280x800 WXGA	1280x800 WXGA	1280x800 WXGA
Pixel Pitch	0.237x0.237	0.237x0.237	0.237x0.237
Pixel Arrangement	R.G.B. Vertical Stripe	R.G.B. Vertical Stripe	R.G.B. Vertical Stripe
Display Mode	Normally White	Normally White	Normally White
Typical White Luminance (cd/m ²) also called Brightness	185	185	200
Luminance Uniformity	N/A	N/A	N/A
Contrast Ratio	300	500	400

LCD 14.1" inch

Item	Specification		
Response Time (Optical Rise Time/Fall Time)msec	25 (rising+falling)	5/11	16
Nominal Input Voltage VDD	+3.3V Typ.	+3.3V	3.3V
Typical Power Consumption (watt)	N/A	4.02 (for backlight unit only)	Total 5.38 Watt (Typ.) @ LCM circuit 1.28Watt (Typ.), Backlight 4.1 Watt (Typ.)
Weight	420 (440max)	425	390(Typ.) 400(Max)
Physical Size(mm)	317.3x242.0x6.0	317.3x242.0x5.9	317.3x242.0x6.5
Electrical Interface	1 channel LVDS	1 channel LVDS	1 channel LVDS
Support Color	262,144	262,144	262,144
Viewing Angle (degree) Horizontal: Right/Left Vertical: Upper/Lower	40/40 10/30	45/45 20/45	40/45 25/30
Temperature Range(° C) Operating Storage (shipping)	0 to +50 -20 to +60	0 to +50 -25 to +60	0 to +50 -20 to +60

LCD Inverter

Item	Specification
Vendor & model name	Darfon/V189-301GP
Brightness conditions	N/A
Input voltage (V)	9~21
Input current (mA)	2.56 (max)
Output voltage (V, rms)	780V (2000V for kick off)
Output current (mA, rms)	6.5 (max)
Output voltage frequency (k Hz)	65K Hz (max)

AC Adaptor

Item	Specification
Input rating	90V AC to 264V AC, 47Hz to 63Hz
Maximum input AC current	1.7A
Inrush current	220A@115VAC 220A@230VAC
Efficiency	82% min. @115VAC input full load

System Power Management

ACPI mode	Power Management
Mech. Off (G3)	All devices in the system are turned off completely.
Soft Off (G2/S5)	OS initiated shutdown. All devices in the system are turned off completely.
Working (G0/S0)	Individual devices such as the CPU and hard disc may be power managed in this state.

System Power Management

ACPI mode	Power Management
Suspend to RAM (S3)	CPU set power down VGA Suspend PCMCIA Suspend Audio Power Down Hard Disk Power Down CD-ROM Power Down Super I/O Low Power mode
Save to Disk (S4)	Also called Hibernation Mode. System saves all system states and data onto the disc prior to power off the whole system.

System Utilities

BIOS Setup Utility

The BIOS Setup Utility is a hardware configuration program built into your computer's BIOS (Basic Input/Output System).

Your computer is already properly configured and optimized, and you do not need to run this utility. However, if you encounter configuration problems, you may need to run Setup. Please also refer to Chapter 4 Troubleshooting when problem arises.

To activate the BIOS Utility, press **F2** during POST (when "Press <F2> to enter Setup" message is prompted on the bottom of screen).

Press **F2** to enter setup. The default parameter of F12 Boot Menu is set to "disabled". If you want to change boot device without entering BIOS Setup Utility, please set the parameter to "enabled".

Press <F12> during POST to enter multi-boot menu. In this menu, user can change boot device without entering BIOS SETUP Utility.

PhoenixBIOS Setup Utility					
Information	Main	Advanced	Security	Boot	Exit
CPU Type :	Genuine Intel (R) CPU	T2250	@1.73GHz		
CPU Speed :	1730 MHz				
IDE1 Model Name :	HTS541010G9AT00				
IDE1 Serial Number :	MP20QAX0J4M0ZR				
ATAPI Model Name:	TSSTcorpCD/DVDW TS-L632D				
System BIOS Version:	V0.310				
VGA BIOS Version:	nVIDIA 5.72.22.46.43				
Serial Number	xxxxxxxxxxxxxxxxxxxxxxx			22 Byte	
Asset Tag Number	N/A			32 Byte	
Produce Name	Aspire 3680/5570/5580; TravelMate 2480/3260/3270			16 Byte	
Manufacturer Name:	Acer Inc.			16 Byte	
UUID:	xxxxxxxxxxxxxxxxxxxxxxx			32 Byte	
F1 Help	↑↓ Select Item	F5/F6 Change Values	F9 Setup Defaults		
Esc Exit	←→ Select Menu	Enter Select	▶ Sub-Menu	F10 Save and Exit	

Navigating the BIOS Utility

There are six menu options: Info., Main, System Devices, Security, Boot, and Exit.

Follow these instructions:

- ❑ To choose a menu, use the cursor left/right keys (← →).
- ❑ To choose a parameter, use the cursor up/down keys (↑ ↓).
- ❑ To change the value of a parameter, press F8 or F6.
- ❑ A plus sign (+) indicates the item has sub-items. Press ENTER to expand this item.
- ❑ Press ESC while you are in any of the menu options to go to the Exit menu.
- ❑ In any menu, you can load default settings by pressing F8. You can also press F6 to save any changes made and exit the BIOS Setup Utility.

NOTE: You can change the value of a parameter if it is enclosed in square brackets. Navigation keys for a particular menu are shown on the bottom of the screen. Help for parameters are found in the Item Specific Help part of the screen. Read this carefully when making changes to parameter values. **Please note that system information is subject to different models.**

Information

PhoenixBIOS Setup Utility					
Information	Main	Advanced	Security	Boot	Exit
CPU Type :	Genuine Intel (R) CPU	T2250	@1.73GHz		
CPU Speed :	1730 MHz				
IDE1 Model Name :	HTS541010G9AT00				
IDE1 Serial Number :	MP20QAX0J4M0ZR				
ATAPI Model Name:	TSSTcorpCD/DVDW TS-L632D				
System BIOS Version:	V0.310				
VGA BIOS Version:	nVIDIA 5.72.22.46.43				
Serial Number	xxxxxxxxxxxxxxxxxxxxxxx			22 Byte	
Asset Tag Number	N/A			32 Byte	
Produce Name	Aspire 3680/5570/5580; TravelMate 2480/3260/3270			16 Byte	
Manufacturer Name:	Acer Inc.			16 Byte	
UUID:	xxxxxxxxxxxxxxxxxxxxxxxxxxxxxxxxxxxx			32 Byte	

F1 Help	↑↓ Select Item	F5/F6 Change Values	F9 Setup Defaults
Esc Exit	←→ Select Menu	Enter Select ▶ Sub-Menu	F10 Save and Exit

NOTE: The system information is subject to different models.

Parameter	Description
CPU Type	This field shows the CPU type and speed of the system.
IDE1 Model Name	This field shows the model name of HDD installed on primary IDE master.
IDE1 Serial Number	This field displays the serial number of HDD installed on primary IDE master.
IDE2 Model Name	This field displays the model name of devices installed on secondary IDE master. The hard disk drive or optical drive model name is automatically detected by the system.
IDE2 Serial Number	This field shows the serial number of devices installed on secondary IDE master.
System BIOS ver	Displays system BIOS version.
VGA BIOS Ver	This field displays the VGA firmware version of the system.
KBC Ver	This field shows the keyboard
Serial Number	This field displays the serial number of this unit.
Asset Tag Number	This field displays the asset tag number of the system.
Product Name	This field shows product name of the system.
Manufacturer Name	This field displays the manufacturer of this system.
UUID Number	This will be visible only when an internal LAN device is presenting. UUID=32bytes

Main

The Main screen displays a summary of your computer hardware information, and also includes basic setup parameters. It allows the user to specify standard IBM PC AT system parameters.

PhoenixBIOS Setup Utility					
Information	Main	Advanced	Security	Boot	Exit
				Item Specific Help	
System Time:	[15:27:09]			<Tab>, <Shift-Tab>, or <Enter> selects field.	
System Date:	[08/09/2006]				
System Memory:	634 KB	Shows system base memory size			
Extended Memory:	1022 MB	Shows extended memory size			
Video Memory:	128MB				
Quiet Boot:	[Enabled]				
Power on display:	[Auto]				
Network boot	[Enabled]				
F12 Boot Menu	[Disabled]				
D2D Recovery	[Enabled]				
F1 Help ↑↓ Select Item F5/F6 Change Values F9 Setup Defaults Esc Exit ←→ Select Menu Enter Select ► Sub-Menu F10 Save and Exit					

NOTE: The screen above is for your reference only. Actual values may differ.

The table below describes the parameters in this screen. Settings in **boldface** are the default and suggested parameter settings.

Parameter	Description	Format/Option
System Time	Sets the system time. The hours are displayed with 24-hour format.	Format: HH:MM:SS (hour:minute:second) System Time
System Date	Sets the system date.	Format MM/DD/YYYY (month/day/year) System Date
System Memory	This field reports the memory size of the system. Memory size is fixed to 640MB	
Extended Memory	This field reports the memory size of the extended memory in the system. Extended Memory size=Total memory size-1MB	
VGA Memory	Shows the VGA memory size. VGA Memory size=64/128MB	
Quiet Boot	Determines if Customer Logo will be displayed or not; shows Summary Screen is disabled or enabled. Enabled: Customer Logo is displayed, and Summary Screen is disabled. Disabled: Customer Logo is not displayed, and Summary Screen is enabled.	Option: Enabled or Disabled
Power on display	Auto: During power process, the system will detect if any display device is connected on external video port. If any external display device is connected, the power on display will be in CRT (or projector) only mode. Otherwise it will be in LCD only mode. Both: Simultaneously enable both the integrated LCD screen and the system's external video port (for an external CRT or projector).	Option: Auto or Both
Network Boot	Enables, disables the system boot from LAN (remote server).	Option: Enabled or Disabled
F12 Boot Menu	Enables, disables Boot Menu during POST.	Option: Disabled or Enabled
D2D Recovery	Enables, disables D2D Recovery function. The function allows the user to create a hidden partition on hard disc drive to store operation system and restore the system to factory defaults.	Option: Enabled or Disabled

NOTE: The sub-items under each device will not be shown if the device control is set to disable or auto. This is because the user is not allowed to control the settings in these cases.

Advanced

The Advanced screen displays advanced settings in BIOS.

PhoenixBIOS Setup Utility		
Information	Main	Advanced
Serial port :	[Auto]	Item Specific Help
Parallel port :	[Enabled]	Configure serial port A using options: [Disabled] No configuration [Enabled] User configuration [Auto] BIOS or OS chooses configuration (OS Controlled) Displayed when controlled by OS
Mode :	[ECP]	
IrDA Port :	[Auto]	
F1 Help ↑↓ Select Item F5/F6 Change Values F9 Setup Defaults Esc Exit ←→ Select Menu Enter Select ▶ Sub-Menu F10 Save and Exit		

The table below describes the parameters in this screen. Settings in **boldface** are the default and suggested parameter settings.

Parameter	Description	Option
Serial port	Displays the settings of the serial port	Enabled or Disabled
Parallel port	Shows the settings of the parallel port	Enabled or Disabled
IrDA Device	Shows the setting of the infrared port	Enabled or Disabled

Security

The Security screen contains parameters that help safeguard and protect your computer from unauthorized use.

PhoenixBIOS Setup Utility					
Information	Main	Advanced	Security	Boot	Exit
Supervisor Password Is : Clear User Password Is : Clear HDD 0 Password Clear Set Supervisor Password [Enter] Set User Password [Enter] Set HDD 0 Password [Enter] Password on Boot [Disabled]					Item Specific Help
					Supervisor Password controls accesses of the whole setup utility. It can be used to boot up when Password on boot is enabled.
F1 Help	↑↓ Select Item	F5/F6 Change Values		F9 Setup Defaults	
Esc Exit	←→ Select Menu	Enter Select ▶ Sub-Menu		F10 Save and Exit	

NOTE: Please refer to “Remove HDD/BIOS Password” section if you need to know how to remove HDD/BIOS Password.

The table below describes the parameters in this screen. Settings in **boldface** are the default and suggested parameter settings.

Parameter	Description	Option
User Password is	Shows the setting of the user password.	Clear or Set
Supervisor Password is	Shows the setting of the Supervisor password	Clear or Set
Set User Password	Press Enter to set the user password. When user password is set, this password protects the BIOS Setup Utility from unauthorized access. The user can enter Setup menu only and does not have right to change the value of parameters.	
Set Supervisor Password	Press Enter to set the supervisor password. When set, this password protects the BIOS Setup Utility from unauthorized access. The user can not either enter the Setup menu nor change the value of parameters.	
Primary HardDisk Security	Enables or disables primary hard disk security function.	
Password on Boot	Defines whether a password is required or not while the events defined in this group happened. The following sub-options are all requires the Supervisor password for changes and should be grayed out if the user password was used to enter setup.	Disabled or Enabled

NOTE: When you are prompted to enter a password, you have three tries before the system halts. Don't forget your password. If you forget your password, you may have to return your notebook computer to your dealer to reset it.

Setting a Password

Follow these steps as you set the user or the supervisor password:

1. Use the **↑** and **↓** keys to highlight the Set Supervisor Password parameter and press the **ENTER** key. The Set Supervisor Password box appears:

Set Supervisor Password

Enter New Password []

Confirm New Password []

2. Type a password in the "Enter New Password" field. The password length can not exceeds 8 alphanumeric characters (A-Z, a-z, 0-9, not case sensitive). Retype the password in the "Confirm New Password" field.

IMPORTANT: Be very careful when typing your password because the characters do not appear on the screen.

3. Press **ENTER**.
4. After setting the password, the computer sets the User Password parameter to "Set".
4. If desired, you can opt to enable the Password on boot parameter.
5. When you are done, press **F10** to save the changes and exit the BIOS Setup Utility.

Removing a Password

Follow these steps:

1. Use the **↑** and **↓** keys to highlight the Set Supervisor Password parameter and press the **ENTER** key. The Set Password box appears:

Set Supervisor Password

Enter current password []

Enter New Password []

Confirm New Password []

2. Type the current password in the Enter Current Password field and press **ENTER**.
3. Press **ENTER** twice **without** typing anything in the Enter New Password and Confirm New Password fields. The computer then sets the Supervisor Password parameter to “Clear”.
4. When you have changed the settings, press **F10** to save the changes and exit the BIOS Setup Utility.

Changing a Password

1. Use the **↑** and **↓** keys to highlight the Set Supervisor Password parameter and press the **ENTER** key. The Set Password box appears:

Set Supervisor Password

Enter current password []

Enter New Password []

Confirm New Password []

2. Type the current password in the Enter Current Password field and press **ENTER**.
3. Type a password in the Enter New Password field. Retype the password in the Confirm New Password field.
4. Press **ENTER**. After setting the password, the computer sets the User Password parameter to “Set”.
5. If desired, you can enable the Password on boot parameter.
6. When you are done, press **F10** to save the changes and exit the BIOS Setup Utility.

If the verification is OK, the screen will display as following.

Setup Notice

Changes have been saved.

[continue]

The password setting is complete after the user presses **F10**.

If the current password entered does not match the actual current password, the screen will show you the Setup Warning.

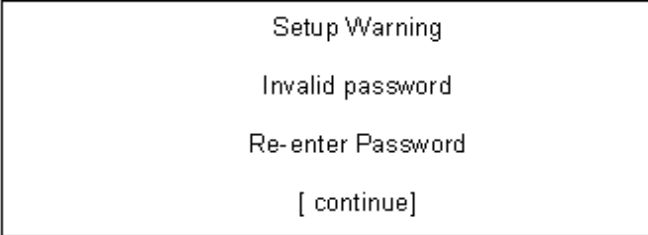

Setup Warning
Invalid password
Re-enter Password
[continue]

If the new password and confirm new password strings do not match, the screen will display the following message.

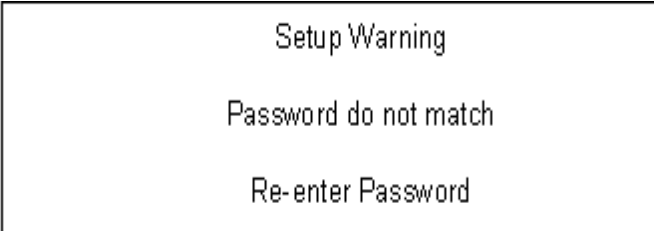

Setup Warning
Password do not match
Re-enter Password

Boot

This menu allows the user to decide the order of boot devices to load the operating system. Bootable devices includes the distette drive in module bay, the onboard hard disk drive and the CD-ROM in module bay.

PhoenixBIOS Setup Utility				
Information	Main	Security	Boot	Exit
Boot priority order: 1: IDE 0: HTS541010G9AT00 - (PM) 2: IDE CDROM: TSSTcorpCD/DVDW TS-L632D- 3: Network Boot: B02 D00 Yukon PXE 4: USB HDD: 5: USB CD-ROM: 6: USB Floppy: 7: USB KEY: 8: Excluded from boot order:			Item Specific Help Keys used to view or configure device: Use Up and Down arrows to select a device. <+> and <-> moves the device up or down. <f> and <r> specifies the device fixed or removable. <x> exclude or include the device to boot. <Shift +1> enables or disables a device. <1 - 4> Loads default boot sequence.	
F1 Help	↑↓ Select Item	F5/F6 Change Values	F9 Setup Defaults	
Esc Exit	←→ Select Menu	Enter Select ▶ Sub-Menu	F10 Save and Exit	

Exit

The Exit screen contains parameters that help safeguard and protect your computer from unauthorized use.

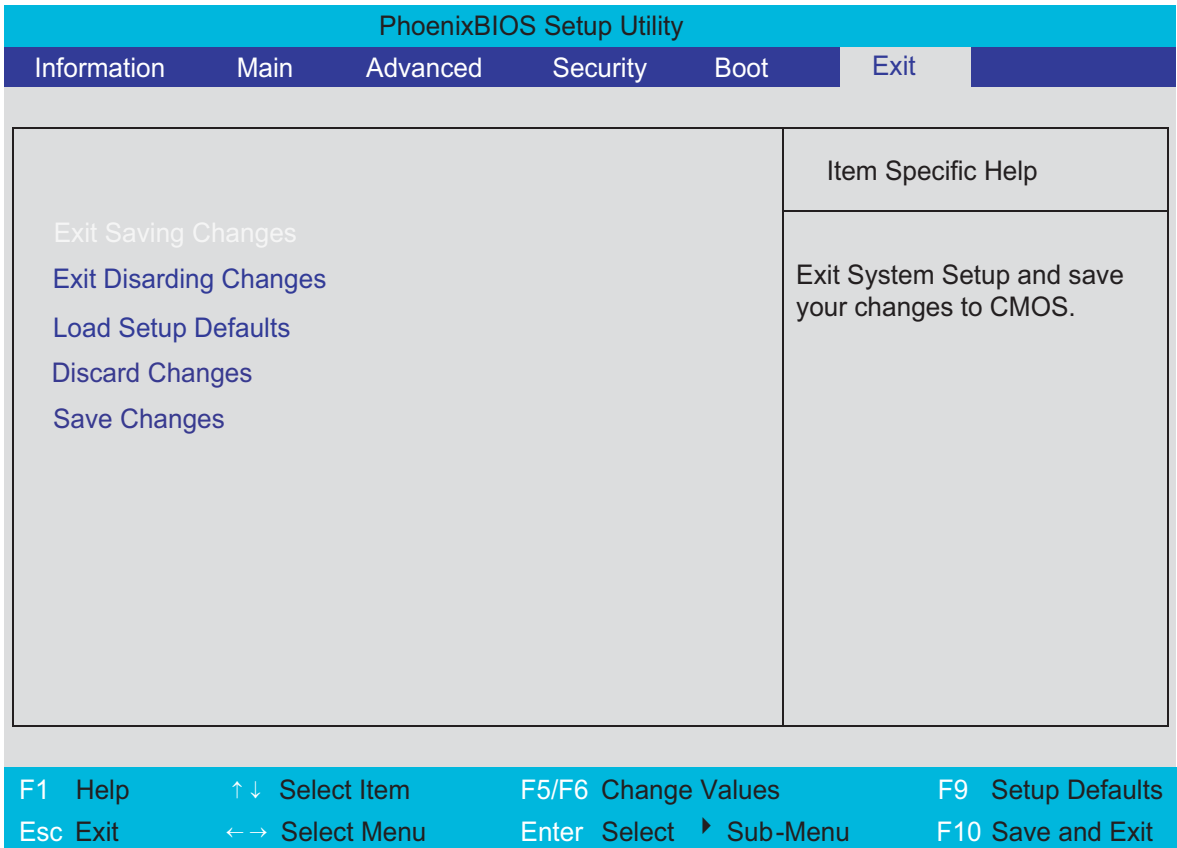

The table below describes the parameters in this screen.

Parameter	Description
Exit Saving Changes	Exit System Setup and save your changes to CMOS.
Exit Discarding Changes	Exit utility without saving setup data to CMOS.
Load Setup Default	Load default values for all SETUP item.
Discard Changes	Load previous values from CMOS for all SETUP items.
Save Changes	Save Setup Data to CMOS.

BIOS Flash Utility

The BIOS flash memory update is required for the following conditions:

- New versions of system programs
- New features or options
- Restore a BIOS when it becomes corrupted.

Use the Phlash utility to update the system BIOS flash ROM.

NOTE: If you do not have a crisis recovery diskette at hand, then you should create a **Crisis Recovery Diskette** before you use the Phlash utility.

NOTE: Do not install memory-related drivers (XMS, EMS, DPMS) when you use the Phlash.

NOTE: Please use the AC adaptor power supply when you run the Phlash utility. If the battery pack does not contain enough power to finish BIOS flash, you may not boot the system because the BIOS is not completely loaded.

Follow the steps below to run the Phlash.

1. Prepare a bootable diskette.
2. Copy the flash utilities to the bootable diskette.
3. Then boot the system from the bootable diskette. The flash utility has auto-execution function.

Remove HDD/BIOS Utility

This section provide you with removing HDD/BIOS method:

Remove HDD Password:

- If you key in wrong HDD password for three time, "HDD password error code" would display on the screen. See the image below.

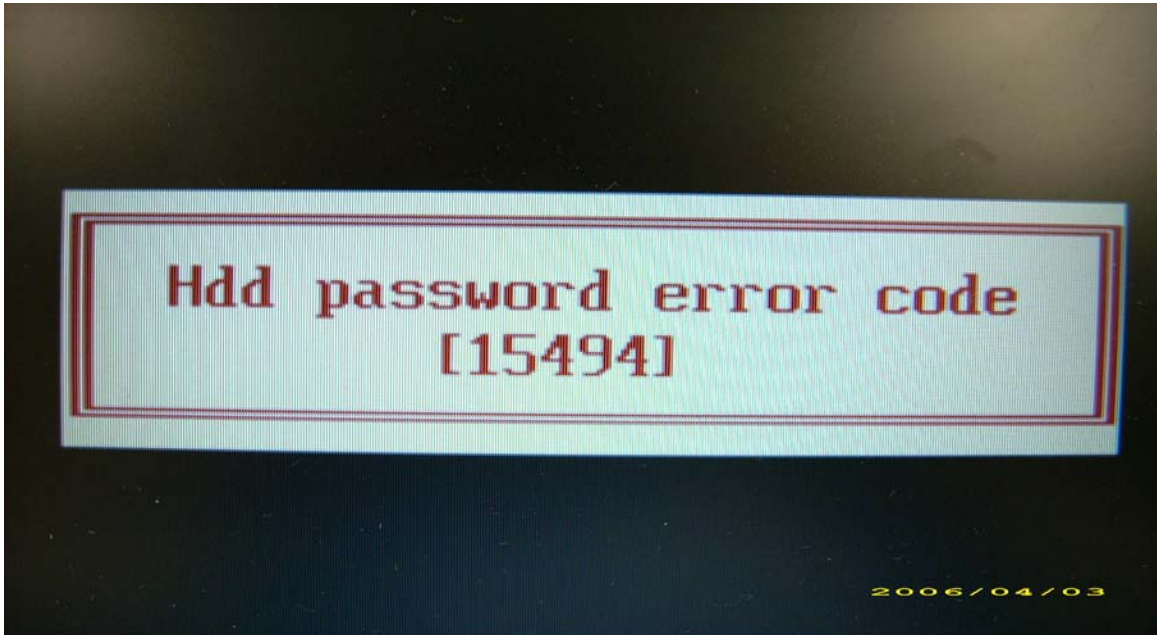

- If you need to solve HDD password locked problem, you can run HDD_PW.EXE
 1. Key in "hdd_pw 15494 0"
 2. Select "2"
 3. Choose one upper-case string

```
C:\WINDOWS\system32\cmd.exe
F:\>cd password
F:\password>dir/w
Volume in drive F has no label.
Volume Serial Number is D4F6-0236

Directory of F:\password

[.]          [..]          BIOS_PW.EXE  HDD_PW.EXE
 1.          2 File(s)         35,354 bytes
            2 Dir(s)         487,895,040 bytes free

F:\password>hdd_pw 15494 0
unlock6.exe v1.1 2 May 2003

Choice what kind of the password to be generated:
0.) Exit....
1.) Scan Code
2.) Upper case ASCII Code
3.) Lower case ASCII Code
Enter your choice: 2
0KJFN42
UVEIQ96
F:\password>
```

- Reboot system and key in "0KJFN42" or "UVEIQ96" to HDD user password.

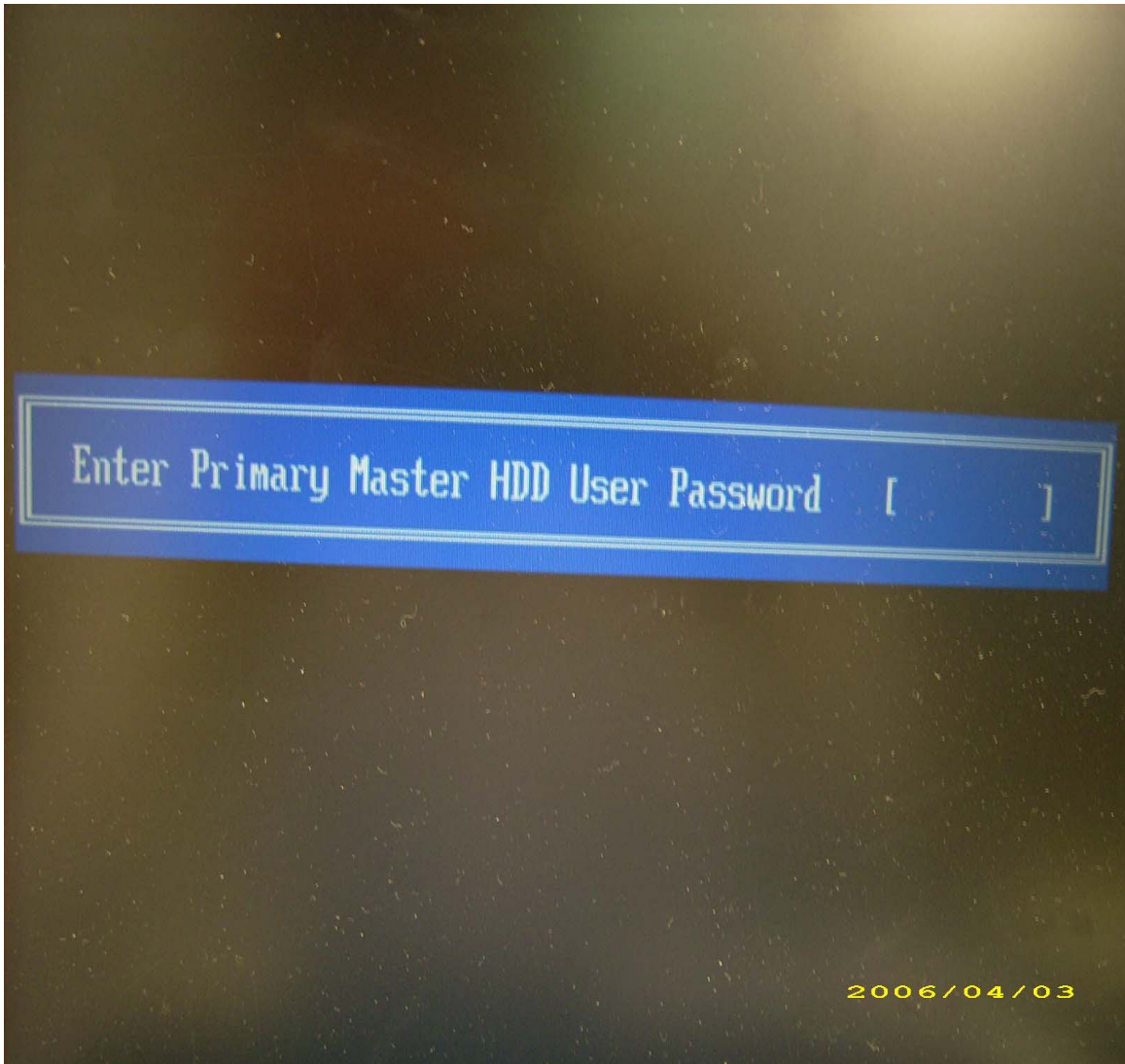

Remove BIOS Password:

- If you key in wrong Supervisor Password for three time, "System Disabled" would display on the screen. See the image below.

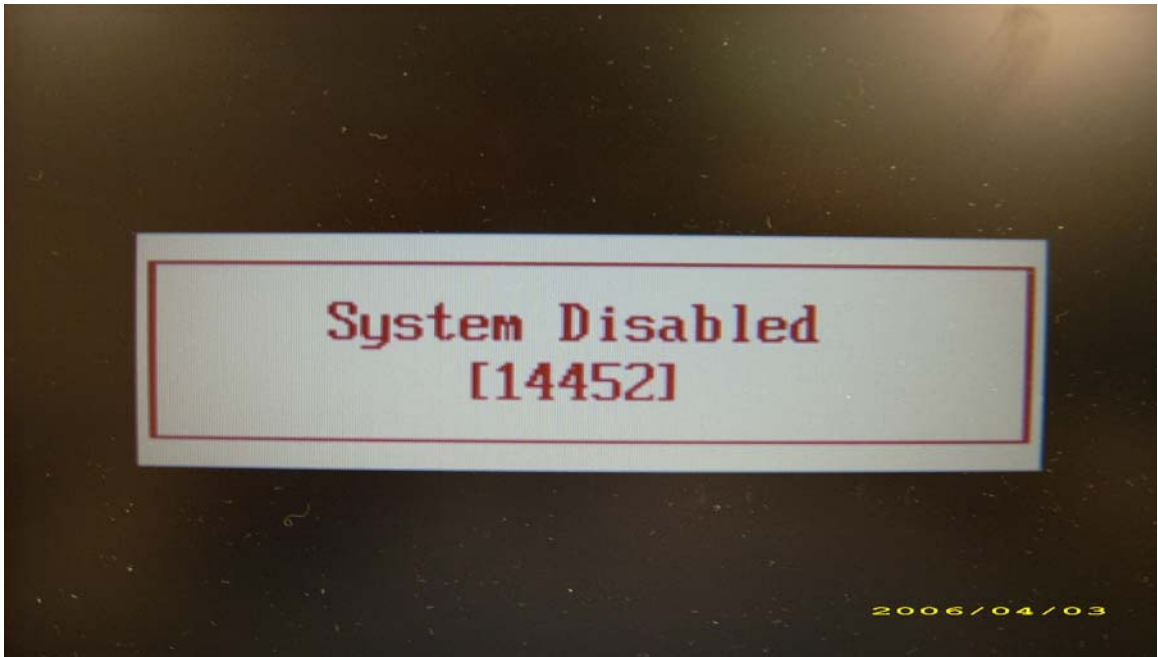

- If you need to solve BIOS password locked problem, you can run BIOS_PW.EXE
 1. Key in "bios_pw 14452 0"
 2. Choose one upper-case string

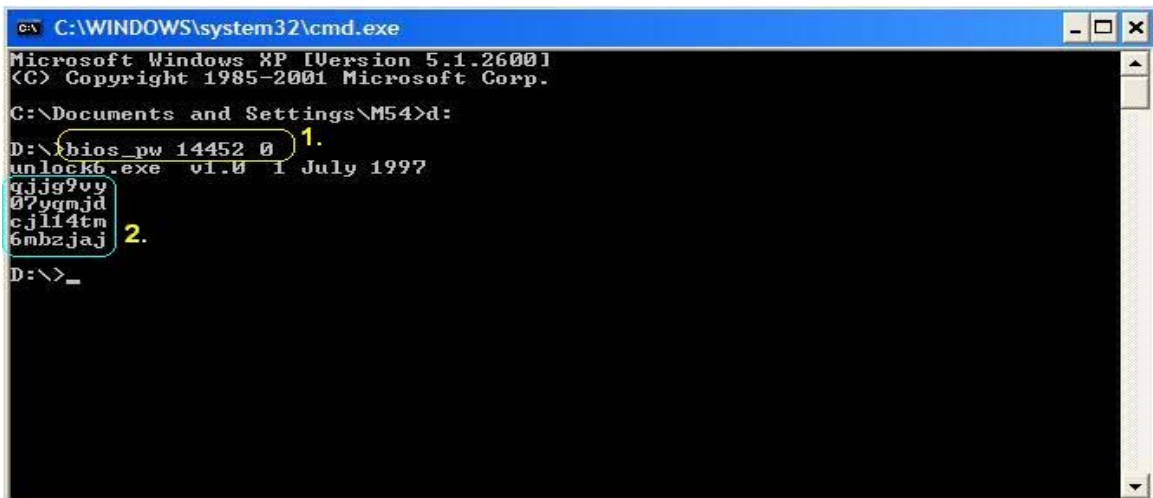

- Reboot the system and key in "qjig9vy" or "07yqmjd" to BIOS user password.

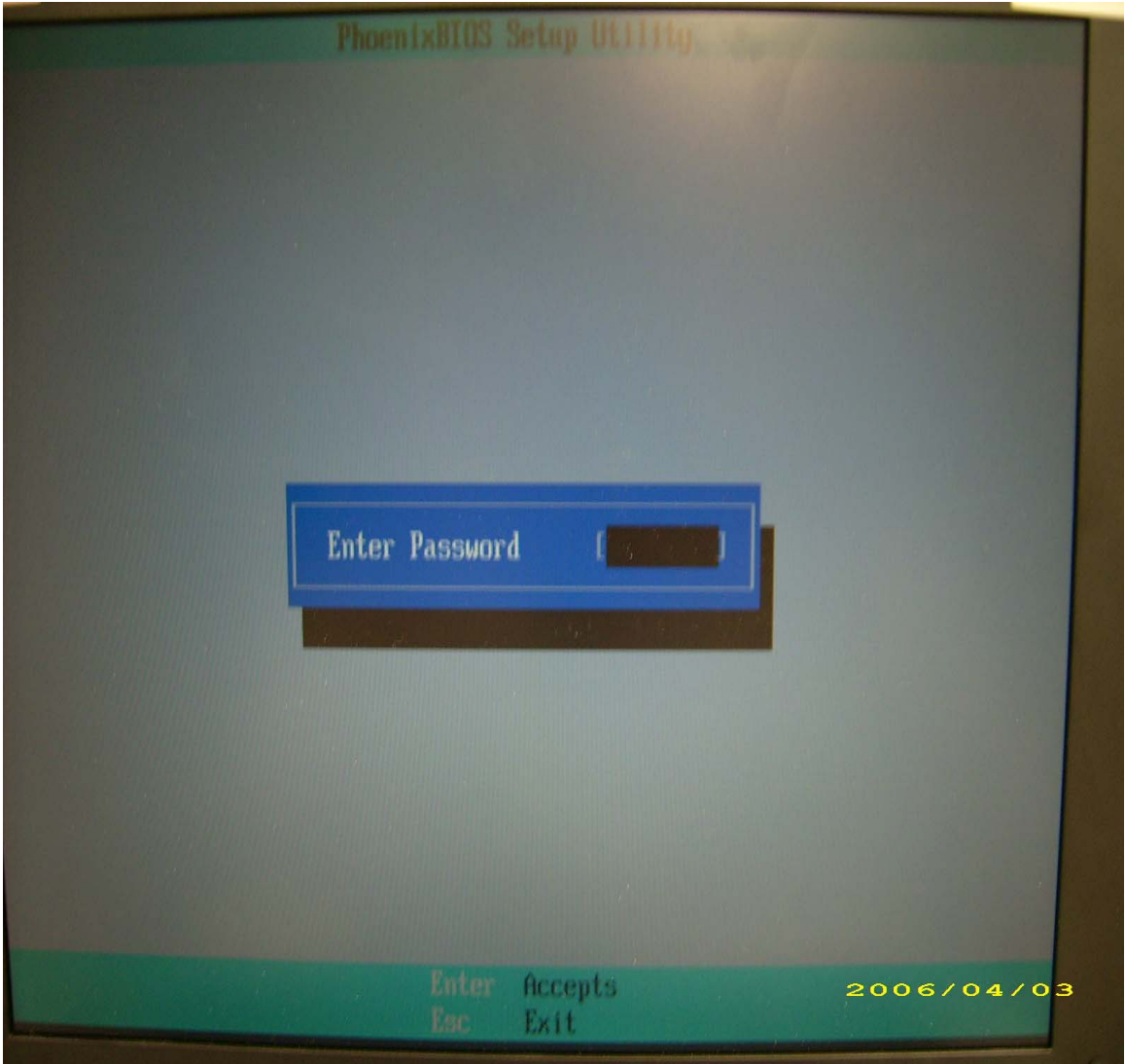

Machine Disassembly and Replacement

This chapter contains step-by-step procedures on how to disassemble the notebook computer for maintenance and troubleshooting.

To disassemble the computer, you need the following tools:

- Wrist grounding strap and conductive mat for preventing electrostatic discharge
- Small Philips screw driver
- Philips screwdriver
- Plastic flat head screw driver
- Tweezers

NOTE: The screws for the different components vary in size. During the disassembly process, group the screws with the corresponding components to avoid mismatch when putting back the components. When you remove the stripe cover, please be careful not to scrape the cover.

General Information

Before You Begin

Before proceeding with the disassembly procedure, make sure that you do the following:

1. Turn off the power to the system and all peripherals.
2. Unplug the AC adapter and all power and signal cables from the system.
3. Remove the battery pack.

Disassembly Procedure Flowchart

The flowchart on the succeeding page gives you a graphic representation on the entire disassembly sequence and instructs you on the components that need to be removed during servicing. For example, if you want to remove the system board, you must first remove the keyboard, then disassemble the inside assembly frame in that order.

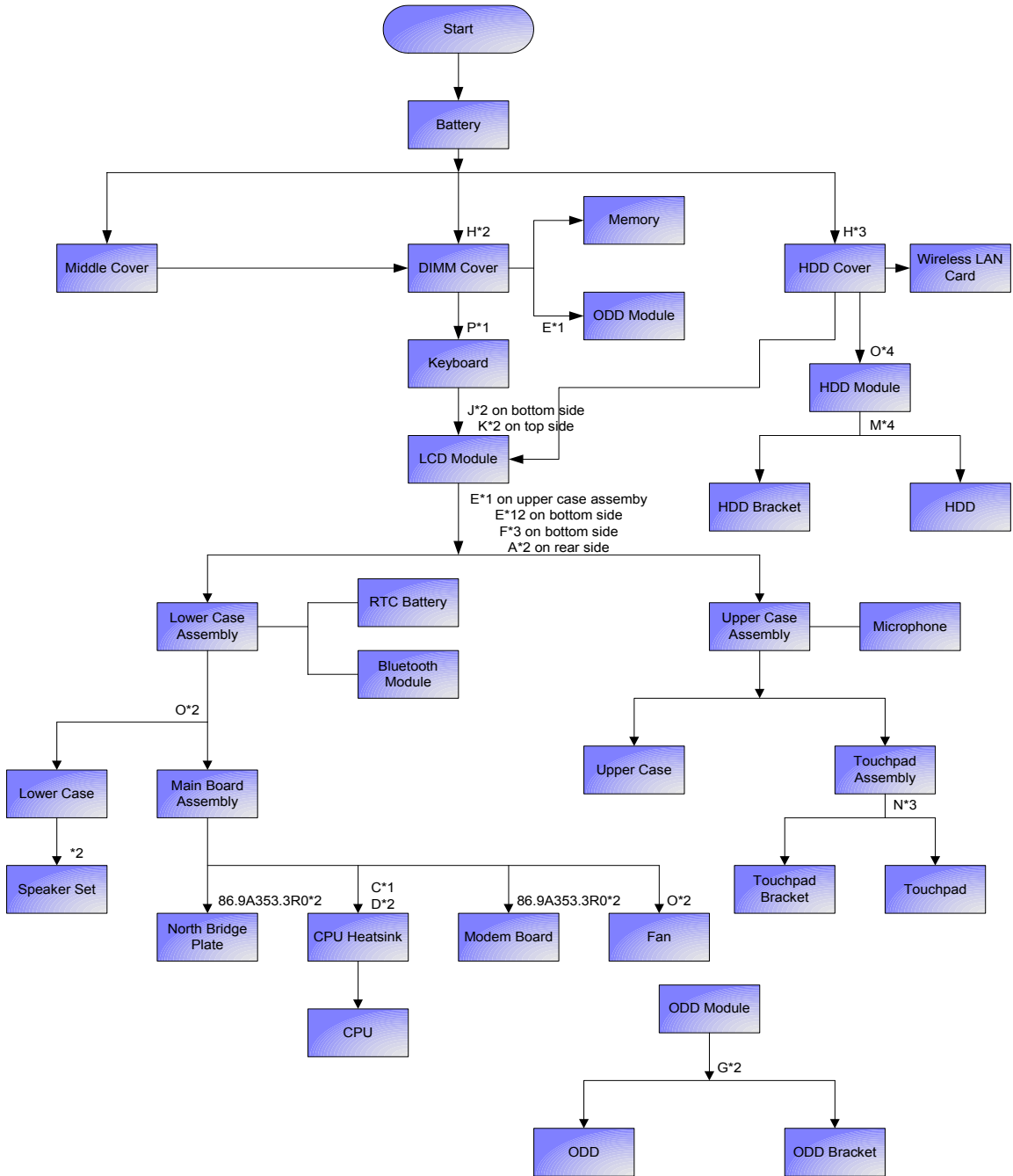

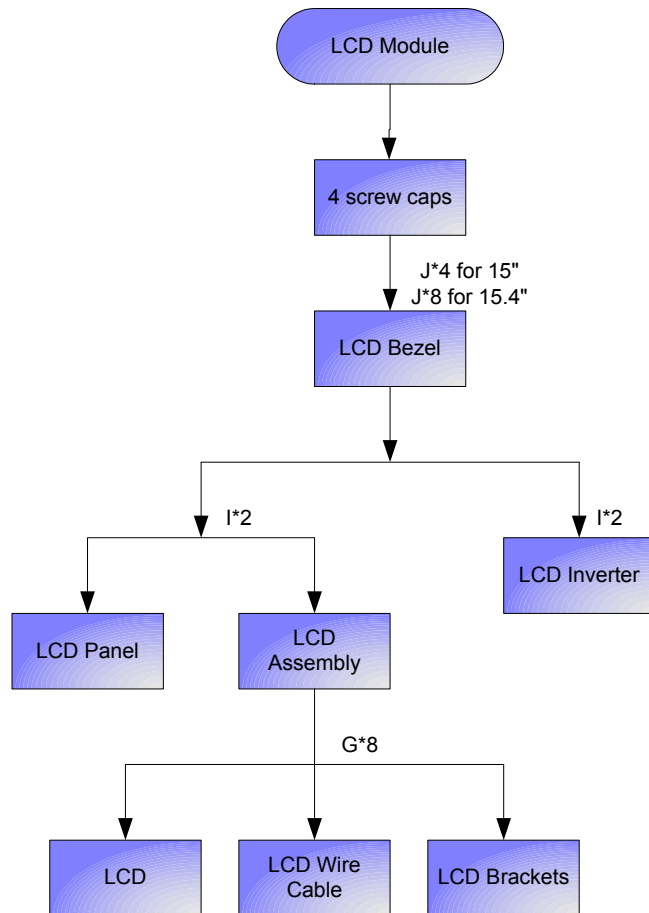

Screw List

Item	Description	Part Number
A	SCW HEX NYL I#R-40/O#4-40 L5.5	34.00015.081
B	SCREW MACH WAFER M2*L4 NI	86.00059.220 (PC Card slot x4)
C	CPU SCREW M2.5*4.3L (2.3 KG)	86.00D01.230
D	CPU SCREW M2.5*4.3L (1.55 KG)	86.00D02.230
E	SCREW M2.5-6	86.9A323.6R0
F	SCRW M2.5*L8(NON NYLOK)	86.9A323.8R0
G	SCREW M2*3 NYLON 1JMCPC-420325	86.9A352.3R0
H	SCREW	86.9A352.4R0
I	SCREW M2.5*4L(NYLOCK)BLACK ZN	86.9A353.4R0
J	SCREW M2.5X6	86.9A353.6R0
K	SRW M2.5*8L B/ZN NYLOK 700	86.9A353.8R0
L	SCRW M2.5*L3(NON NYLOK)	86.9A523.3R0
M	SCREW M3x4(86.9A524.4R0)	86.9A524.4R0
N	SCREW WAFER NYLOK NI 2ML3	86.9A552.3R0
O	SCRW M2*4 WAFER NI	86.9A552.4R0
P	SCRW M2.5*3 WAFER NI	86.9A553.3R0

Removing the Battery Pack

1. Unlock the battery lock.
2. Slide the battery latch then remove the battery.

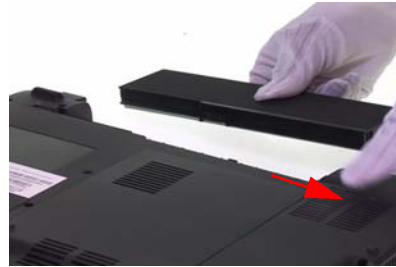
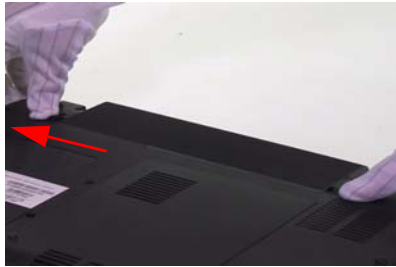

Removing the HDD Module/the Memory/the Wireless LAN Card/the Modem Board/the ODD Module and the LCD Module

Removing the HDD Module

1. Remove the two screws fastening the HDD cover.
2. Detach the HDD cover from the main unit.



3. Remove the screw holding the HDD module as shown.
4. Then disconnect the entire HDD module from the main unit.



Removing the Memory/the Wireless LAN Card/the Modem Board

1. Remove the two screws fastening the RAM cover.
2. Detach the RAM cover from the main unit.



3. Pop out the memories and remove the memories from the memory sockets.
4. Disconnect the main and auxiliary wireless antennae from the wireless LAN card.
5. Remove the two screws fastening the wireless LAN card.



6. Remove the wireless LAN card from the socket.
7. Remove the two screws holding the modem board to the main board as shown.
8. Detach the modem board from the main board then disconnect the modem board cable.

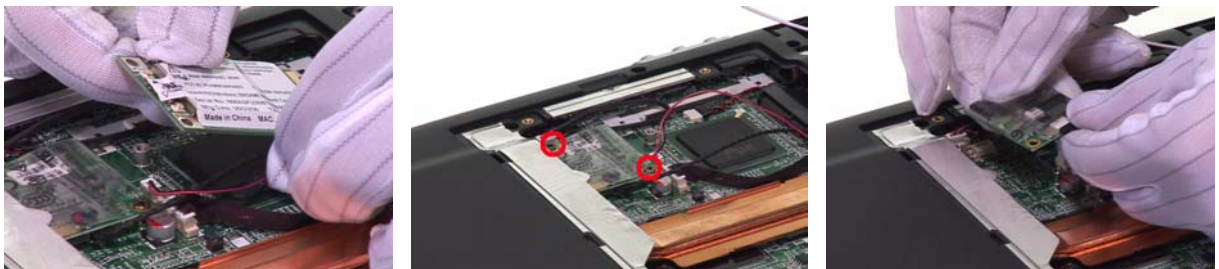

Removing the ODD Module

1. Remove one screw holding the ODD module on the bottom side.
2. Push the ODD module outwards then remove it.



Removing the LCD Module (including Keyboard)

1. Remove the two screws holding the keyboard cover to the main unit.
2. Open the LCD 180 degree as shown.
3. Carefully detach the keyboard cover from the main unit.



4. Remove the two screw fastening the keyboard to the upper case.
5. Disconnect the microphone cable from the launch board.

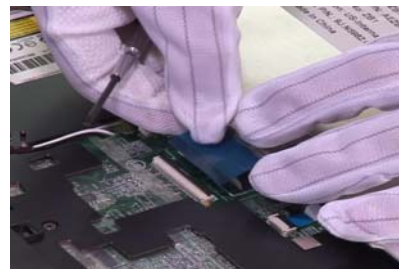

6. Take out the wireless LAN antenna set from the guide-line as shown.
7. Disconnect the LCD cable from the main board.
8. Disconnect the lid switch cable from the main board.

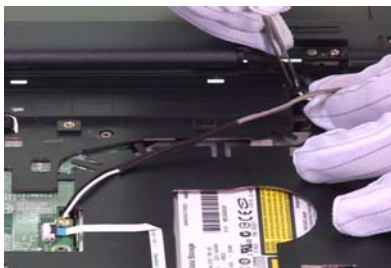

9. If you laptop has CCD module (web camera module), please disconnect CCD cable as shown.
10. Remove four screws holding the LCD module to the upper and lower case assembly.
11. Detach the entire LCD module.

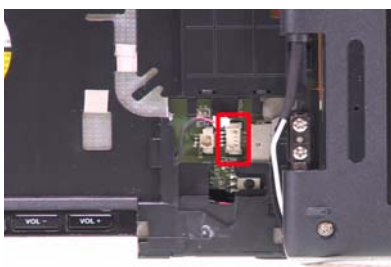

Disassembling the Main Unit

Separating the Main Unit into Upper Case and Lower Case Assembly

1. Remove three screws fastening the upper case assembly and the lower case assembly.
2. Remove 18 screws (M2.5L6x17; M2.0L1.7x1) holding the upper assembly and the lower case assembly on the bottom.
3. Detach the upper case assembly from the lower case assembly.



Disassembling the Upper Case Assembly

1. Remove the two screws fastening the media board.
2. Use a tweezers or a flat-headed screwdriver to detach the media board from the upper case.

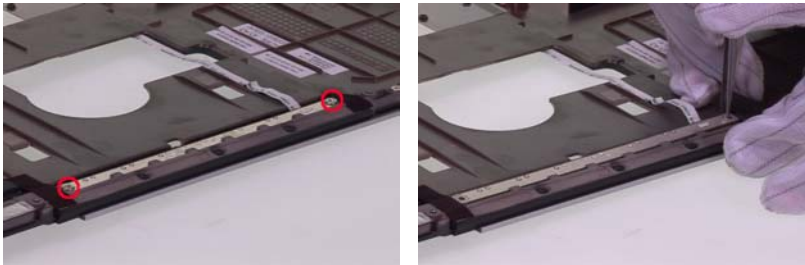

3. Take out the media board from the upper case.
4. Disconnect the media board FFC from the media board then remove the board and the FFC.

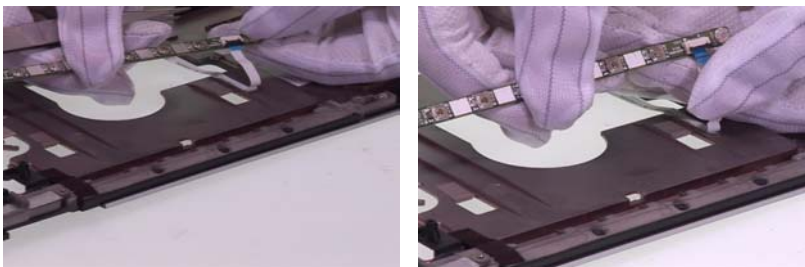

Disassembling the Lower Case Assembly

1. Disconnect the Bluetooth cable from the main board.
2. Detach the Bluetooth module from the lower case and then detach the Bluetooth cable.
3. Disconnect the speaker cable from the main board.

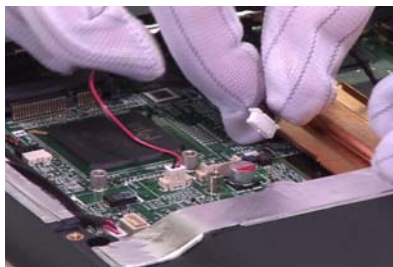

4. Disconnect the microphone cable from the main board.
5. Remove the two screws fastening the main board to the lower case.
6. Carefully detach the main board from the lower case as shown.



7. Remove the two screws holding the daughter board to the main board.
8. Then detach the daughter board from the main board.
9. Disconnect the fan cable from the main board.

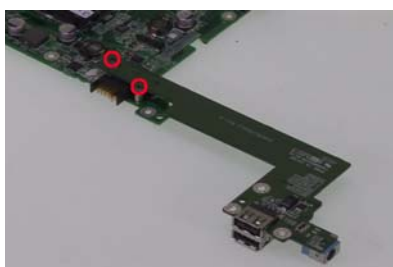

10. Remove the six screws fastening the thermal module.
11. Detach the thermal module from the main board.
12. Use a flat-bladed screwdriver to release the CPU lock then carefully remove the CPU. (Please turn anti-clockwise to release the CPU lock).



Disassembling the LCD Module (with video camera)

1. Remove the six screw caps as shown.
2. Remove the six screws holding the LCD bezel.
3. Then detach the LCD bezel from the LCD module.



4. Take out the inverter from the LCD cover and disconnect the LVDS cable as shown.
5. Disconnect the inverter cable then take out the inverter.
6. Remove five screws holding the LCD assembly to the LCD cover.



7. Take out the LCD assembly from the LCD cover.
8. Remove the screws holding the CCD module.
9. Disconnect the CCD cable from the CCD module.



10. Remove the two screws holding the right LCD bracket.
11. Then remove the right LCD bracket.
12. Remove the two screws fastening the left LCD bracket.

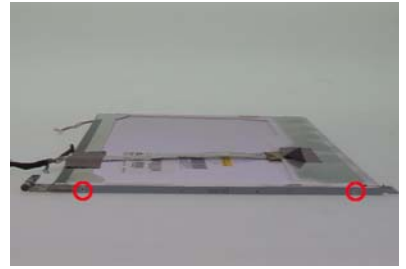
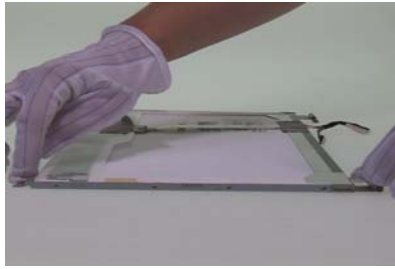
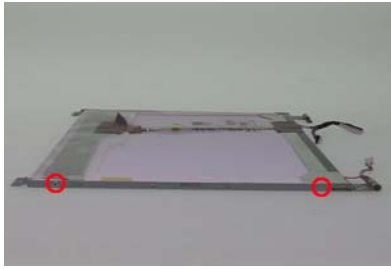

- 13.** Then remove the left LCD bracket from the LCD.
- 14.** Tear off the mylar fastening the LCD cable.
- 15.** Disconnect the LCD cable from the LCD.

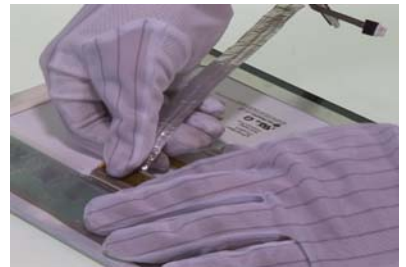
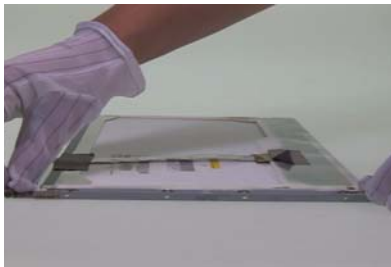

Disassembling the External Modules

Disassembling the HDD Module

1. Remove two screws holding the HDD bracket.
2. Then remove two screws fastening the HDD bracket on the other side.
3. Remove the HDD bracket.

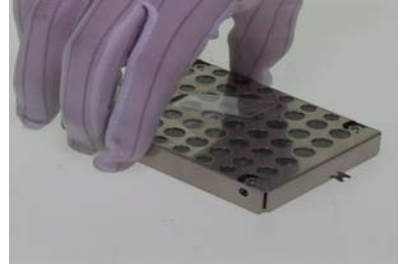
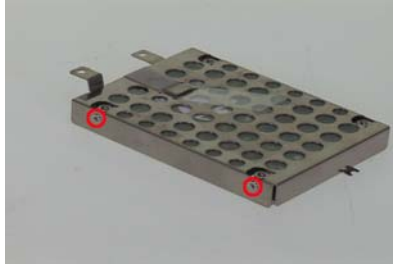
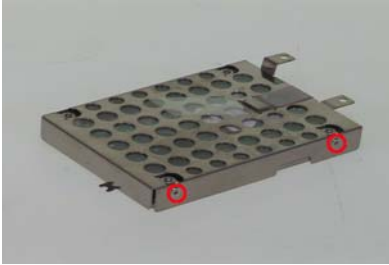

Disassembling the ODD Module

1. Remove the two screws holding the ODD bracket.
2. Then remove the ODD bracket.
3. Detach the ODD bezel carefully.



Troubleshooting

Use the following procedure as a guide for computer problems.

NOTE: The diagnostic tests are intended to test only Acer products. Non-Acer products, prototype cards, or modified options can give false errors and invalid system responses.

1. Obtain the failing symptoms in as much detail as possible.
2. Verify the symptoms by attempting to re-create the failure by running the diagnostic test or by repeating the same operation.
3. Use the following table with the verified symptom to determine which page to go to.

Symptoms (Verified)	Go To
Power failure. (The power indicator does not go on or stay on.)	"Power System Check" on page 81.
POST does not complete. No beep or error codes are indicated.	"Power-On Self-Test (POST) Error Message" on page 84 "Undetermined Problems" on page 96
POST detects an error and displayed messages on screen.	"Error Message List" on page 85
Other symptoms (i.e. LCD display problems or others).	"Power-On Self-Test (POST) Error Message" on page 84
Symptoms cannot be re-created (intermittent problems).	Use the customer-reported symptoms and go to "Power-On Self-Test (POST) Error Message" on page 84 "Intermittent Problems" on page 95 "Undetermined Problems" on page 96

System Check Procedures

External Diskette Drive Check

Do the following to isolate the problem to a controller, driver, or diskette. A write-enabled, diagnostic diskette is required.

NOTE: Make sure that the diskette does not have more than one label attached to it. Multiple labels can cause damage to the drive or cause the drive to fail.

Do the following to select the test device.

1. Boot from the diagnostics diskette and start the diagnostics program.
2. See if FDD Test is passed as the program runs to FDD Test.
3. Follow the instructions in the message window.

If an error occurs with the internal diskette drive, reconnect the diskette connector on the system board.

If the error still remains:

1. Reconnect the external diskette drive/DVD-ROM module.
2. Replace the external diskette drive/CD-ROM module.
3. Replace the main board.

External CD-ROM Drive Check

Do the following to isolate the problem to a controller, drive, or CD-ROM. Make sure that the CD-ROM does not have any label attached to it. The label can cause damage to the drive or can cause the drive to fail.

Do the following to select the test device:

1. Boot from the diagnostics diskette and start the diagnostics program.
2. See if CD-ROM Test is passed when the program runs to CD-ROM Test.
3. Follow the instructions in the message window.

If an error occurs, reconnect the connector on the System board. If the error still remains:

1. Reconnect the external diskette drive/CD-ROM module.
2. Replace the external diskette drive/CD-ROM module.
3. Replace the main board.

Keyboard or Auxiliary Input Device Check

Remove the external keyboard if the internal keyboard is to be tested.

If the internal keyboard does not work or an unexpected character appears, make sure that the flexible cable extending from the keyboard is correctly seated in the connector on the system board.

If the keyboard cable connection is correct, run the Keyboard Test.

If the tests detect a keyboard problem, do the following one at a time to correct the problem. Do not replace a non-defective FRU:

1. Reconnect the keyboard cables.
2. Replace the keyboard.
3. Replace the main board.

The following auxiliary input devices are supported by this computer:

- Numeric keypad
- External keyboard

If any of these devices do not work, reconnect the cable connector and repeat the failing operation.

Memory check

Memory errors might stop system operations, show error messages on the screen, or hang the system.

1. Boot from the diagnostics diskette and start the doagmpstotics program (please refer to main board).
2. Go to the diagnostic memory in the test items.
3. Press F2 in the test items.
4. Follow the instructions in the message window.

NOTE: Make sure that the DIMM is fully installed into the connector. A loose connection can cause an error.

Power System Check

To verify the symptom of the problem, power on the computer using each of the following power sources:

1. Remove the battery pack.
2. Connect the power adapter and check that power is supplied.
3. Disconnect the power adapter and install the charged battery pack; then check that power is supplied by the battery pack.

If you suspect a power problem, see the appropriate power supply check in the following list:

- “Check the Power Adapter” on page 82
- “Check the Battery Pack” on page 83

Check the Power Adapter

Unplug the power adapter cable from the computer and measure the output voltage at the plug of the power adapter cable. See the following figure

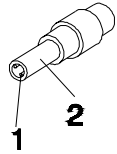

Pin 1: +19 to +20.5V
Pin 2: 0V, Ground

1. If the voltage is not correct, replace the power adapter.
2. If the voltage is within the range, do the following:
 - Replace the System board.
 - If the problem is not corrected, see “Undetermined Problems” on page 96.
 - If the voltage is not correct, go to the next step.

NOTE: An audible noise from the power adapter does not always indicate a defect.

3. If the power-on indicator does not light up, check the power cord of the power adapter for correct continuity and installation.
4. If the operational charge does not work, see “Check the Battery Pack” on page 83.

Check the Battery Pack

To check the battery pack, do the following:

From Software:

1. Check out the Power Management in control Panel
2. In Power Meter, confirm that if the parameters shown in the screen for Current Power Source and Total Battery Power Remaining are correct.
3. Repeat the steps 1 and 2, for both battery and adapter.
4. This helps you identify first the problem is on recharging or discharging.

From Hardware:

1. Power off the computer.
2. Remove the battery pack and measure the voltage between battery terminals 1(+) and 6(ground). See the following figure

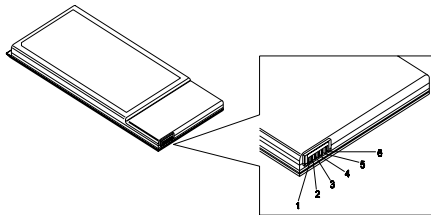

3. If the voltage is still less than 7.5 Vdc after recharging, replace the battery.

To check the battery charge operation, use a discharged battery pack or a battery pack that has less than 50% of the total power remaining when installed in the computer.

If the battery status indicator does not light up, remove the battery pack and let it return to room temperature. Re-install the battery pack.

If the charge indicator still does not light up, replace the battery pack. If the charge indicator still does not light up, replace the DC/DC charger board.

Touchpad Check

If the touchpad doesn't work, do the following actions one at a time to correct the problem. Do not replace a non-defective FRU:

1. Reconnect the touchpad cables.
2. Replace the touchpad.
3. Replace the system board.

After you use the touchpad, the pointer drifts on the screen for a short time. This self-acting pointer movement can occur when a slight, steady pressure is applied to the touchpad pointer. This symptom is not a hardware problem. No service actions are necessary if the pointer movement stops in a short period of time.

Power-On Self-Test (POST) Error Message

The POST error message index lists the error message and their possible causes. The most likely cause is listed first.

NOTE: Perform the FRU replacement or actions in the sequence shown in FRU/Action column, if the FRU replacement does not solve the problem, put the original part back in the computer. Do not replace a non-defective FRU.

This index can also help you determine the next possible FRU to be replaced when servicing a computer.

If the symptom is not listed, see “Undetermined Problems” on page 96.

The following lists the error messages that the BIOS displays on the screen and the error symptoms classified by function.

NOTE: Most of the error messages occur during POST. Some of them display information about a hardware device, e.g., the amount of memory installed. Others may indicate a problem with a device, such as the way it has been configured.

NOTE: If the system fails after you make changes in the BIOS Setup Utility menus, reset the computer, enter Setup and install Setup defaults or correct the error.

Index of Error Messages

Error Code List

Error Codes	Error Messages
006	Equipment Configuration Error Causes: 1. CPU BIOS Update Code Mismatch 2. IDE Primary Channel Master Drive Error (The causes will be shown before "Equipment Configuration Error")
010	Memory Error at xxxx:xxxx:xxxxh (R:xxxxh, W:xxxxh)
070	Real Time Clock Error
071	CMOS Battery Bad
072	CMOS Checksum Error
110	System disabled. Incorrect password is specified.
<No error code>	Battery critical LOW In this situation BIOS will issue 4 short beeps then shut down system, no message will show.
<No error code>	Thermal critical High In this situation BIOS will shut down system, not show message.

Error Message List

Error Messages	FRU/Action in Sequence
Failure Fixed Disk	Reconnect hard disk drive connector. "Load Default Settings" in BIOS Setup Utility. Hard disk drive System board
Stuck Key	see "Keyboard or Auxiliary Input Device Check" on page 80.
Keyboard error	see "Keyboard or Auxiliary Input Device Check" on page 80.
Keyboard Controller Failed	see "Keyboard or Auxiliary Input Device Check" on page 80.
Keyboard locked - Unlock key switch	Unlock external keyboard
Monitor type does not match CMOS - Run Setup	Run "Load Default Settings" in BIOS Setup Utility.
Shadow RAM Failed at offset: nnnn	BIOS ROM System board
System RAM Failed at offset: nnnn	DIMM System board
Extended RAM Failed at offset: nnnn	DIMM System board
System battery is dead - Replace and run Setup	Replace RTC battery and Run BIOS Setup Utility to reconfigure system time, then reboot system.
System CMOS checksum bad - Default configuration used	RTC battery Run BIOS Setup Utility to reconfigure system time, then reboot system.
System timer error	RTC battery Run BIOS Setup Utility to reconfigure system time, then reboot system. System board

Error Message List

Error Messages	FRU/Action in Sequence
Real time clock error	RTC battery Run BIOS Setup Utility to reconfigure system time, then reboot system. System board
Previous boot incomplete - Default configuration used	Run "Load Default Settings" in BIOS Setup Utility. RTC battery System board
Memory size found by POST differed from CMOS	Run "Load Default Settings" in BIOS Setup Utility. DIMM System board
Diskette drive A error	Check the drive is defined with the proper diskette type in BIOS Setup Utility See "External Diskette Drive Check" on page 80.
Incorrect Drive A type - run SETUP	Check the drive is defined with the proper diskette type in BIOS Setup Utility
System cache error - Cache disabled	System board
CPU ID:	System board
DMA Test Failed	DIMM System board
Software NMI Failed	DIMM System board
Fail-Safe Timer NMI Failed	DIMM System board
Device Address Conflict	Run "Load Default Settings" in BIOS Setup Utility. RTC battery System board
Allocation Error for device	Run "Load Default Settings" in BIOS Setup Utility. RTC battery System board
Failing Bits: nnnn	DIMM BIOS ROM System board
Fixed Disk n	None
Invalid System Configuration Data	BIOS ROM System board
I/O device IRQ conflict	Run "Load Default Settings" in BIOS Setup Utility. RTC battery System board
Operating system not found	Enter Setup and see if fixed disk and drive A: are properly identified. Diskette drive Hard disk drive System board

Error Message List

No beep Error Messages	FRU/Action in Sequence
No beep, power-on indicator turns off and LCD is blank.	Power source (battery pack and power adapter). See "Power System Check" on page 81.. Ensure every connector is connected tightly and correctly. Reconnect the DIMM. LED board. System board.
No beep, power-on indicator turns on and LCD is blank.	Power source (battery pack and power adapter). See "Power System Check" on page 81.. Reconnect the LCD connector Hard disk drive LCD inverter ID LCD cable LCD Inverter LCD System board
No beep, power-on indicator turns on and LCD is blank. But you can see POST on an external CRT.	Reconnect the LCD connectors. LCD inverter ID LCD cable LCD inverter LCD System board
No beep, power-on indicator turns on and a blinking cursor shown on LCD during POST.	Ensure every connector is connected tightly and correctly. System board
No beep during POST but system runs correctly.	Speaker System board

Phoenix BIOS Beep Codes

Code	Beeps	POST Routine Description
02h		Verify Real Mode
03h		Disable Non-Maskable Interrupt (NMI)
04h		Get CPU type
06h		Initialize system hardware
08h		Initialize chipset with initial POST values
09h		Set IN POST flag
0Ah		Initialize CPU registers
0Bh		Enable CPU cache
0Ch		Initialize caches to initial POST values
0Eh		Initialize I/O component
0Fh		Initialize the local bus IDE
10h		Initialize Power Management
11h		Load alternate registers with initial POST values
12h		Restore CPU control word during warm boot
13h		Initialize PCI Bus Mastering devices
14h		Initialize keyboard controller
16h	1-2-2-3	BIOS ROM checksum
17h		Initialize cache before memory autosize
18h		8254 timer initialization
1Ah		8237 DMA controller initialization
1Ch		Reset Programmable Interrupt Controller
20h	1-3-1-1	Test DRAM refresh
22h	1-3-1-3	Test 8742 Keyboard Controller
24h		Set ES segment register to 4 GB
26h		Enable A20 line
28h		Autosize DRAM
29h		Initialize POST Memory Manager
2Ah		Clear 215 KB base RAM
2Ch	1-3-4-1	RAM failure on address line xxxx
2Eh	1-3-4-3	RAM failure on data bits xxxx of low byte of memory bus
2Fh		Enable cache before system BIOS shadow
30h	1-4-1-1	RAM failure on data bits xxxx of high byte of memory bus
32h		Test CPU bus-clock frequency
33h		Initialize Phoenix Dispatch Manager
36h		Warm start shut down
38h		Shadow system BIOS ROM
3Ah		Autosize cache
3Ch		Advanced configuration of chipset registers
3Dh		Load alternate registers with CMOS values
42h		Initialize interrupt vectors
45h		POST device initialization

Code	Beeps	POST Routine Description
46h	2-1-2-3	Check ROM copyright notice
48h		Check video configuration against CMOS
49h		Initialize PCI bus and devices
4Ah		Initialize all video adapters in system
4Bh		QuietBoot start (optional)
4Ch		Shadow video BIOS ROM
4Eh		Display BIOS copyright notice
50h		Display CPU type and speed
51h		Initialize EISA board
52h		Test keyboard
54h		Set key click if enabled
58h	2-2-3-1	Test for unexpected interrupts
59h		Initialize POST display service
5Ah		Display prompt "Press F2 to enter SETUP"
5Bh		Disable CPU cache
5Ch		Test RAM between 512 and 640 KB
60h		Test extended memory
62h		Test extended memory address lines
64h		Jump to User Patch1
66h		Configure advanced cache registers
67h		Initialize Multi Processor APIC
68h		Enable external and CPU caches
69h		Setup System Management Mode (SMM) area
6Ah		Display external L2 cache size
6Bh		Load custom defaults (optional)
6Ch		Display shadow-area message
6Eh		Display possible high address for UMB recovery
70h		Display error messages
72h		Check for configuration errors
76h		Check for keyboard errors
7Ch		Set up hardware interrupt vectors
7Eh		Initialize coprocessor if present
80h		Disable onboard Super I/O ports and IRQs
81h		Late POST device initialization
82h		Detect and install external RS232 ports
83h		Configure non-MCD IDE controllers
84h		Detect and install external parallel ports
85h		Initialize PC-compatible PnP ISA devices
86h		Re-initialize onboard I/O ports
87h		Configure Motherboard Configurable Devices (optional)
88h		Initialize BIOS Area
89h		Enable Non-Maskable Interrupts (NMI)
8Ah		Initialize Extended BIOS Data Area
8Bh		Test and initialize PS/2 mouse

Code	Beeps	POST Routine Description
8Ch		Initialize floppy controller
8Fh		Determine number of ATA drives (optional)
90h		Initialize hard-disk controllers
91h		Initialize local-bus hard-disk controllers
92h		Jump to UserPatch2
93h		Build MPTABLE for multi-processor boards
95h		Install CD ROM for boot
96h		Clear huge ES segment register
97h		Fixup Multi Processor table
98h	1-2	Search for option ROMs. One long, two short beeps on checksum failure.
99h		Check for SMART drive (optional)
9Ah		Shadow option ROMs
9Ch		Set up Power Management
9Dh		Initialize security engine (optional)
9Eh		Enable hardware interrupts
9Fh		Determine number of ATA and SCSI drives
A0h		Set time of day
A2h		Check key lock
A4h		Initialize Typematic rate
A8h		Erase F2 prompt
AAh		Scan for F2 key stroke
ACh		Enter SETUP
AEh		Clear Boot flag
B0h		Check for errors
B2h		POST done- prepare to boot operating system
B4h	1	One short beep before boot
B5h		Terminate QuietBoot (optional)
B6h		Check password (optional)
B9h		Prepare Boot
BAh		Initialize DMI parameters
BBh		Initialize PnP Option ROMs
BCh		Clear parity checkers
BDh		Display MultiBoot menu
BEh		Clear screen (optional)
BFh		Check virus and backup reminders
C0h		Try to boot with INT 19
C1h		Initialize POST Error Manager (PEM)
C2h		Initialize error logging
C3h		Initialize error display function
C4h		Initialize system error handler
C5h		PnPnd dual CMOS (optional)
C6h		Initialize notebook docking (optional)
C7h		Initialize notebook docking late
C8h		Force check (optional)
C9h		Extended checksum (optional)

Code	Beeps	POST Routine Description
D2h		Unknown interrupt

Code	Beeps	POST Routine Description
E0h		Initialize the chipset
E1h		Initialize the bridge
E2h		Initialize the CPU
E3h		Initialize the system timer
E4h		Initialize system I/O
E5h		Check force recovery boot
E6h		Checksum BIOS ROM
E7h		Go to BIOS
E8h		Set Huge Segment
E9h		Initialize Multi Processor
EAh		Initialize OEM special code
EBh		Initialize PIC and DMA
ECh		Initialize Memory type
EDh		Initialize Memory size
EEh		Shadow Boot Block
EFh		System memory test
F0h		Initialize interrupt vectors
F1h		Initialize Run Time Clock
F2h		Initialize video
F3h		Initialize System Management Mode
F4h	1	Output one beep before boot
F5h		Boot to Mini DOS
F6h		Clear Huge Segment
F7h		Boot to Full DOS

Index of Symptom-to-FRU Error Message

LCD-Related Symptoms

Symptom / Error	Action in Sequence
LCD backlight doesn't work LCD is too dark LCD brightness cannot be adjusted LCD contrast cannot be adjusted	Enter BIOS Utility to execute "Load Setup Default Settings", then reboot system. Reconnect the LCD connectors. Keyboard (if contrast and brightness function key doesn't work). LCD inverter ID LCD cable LCD inverter LCD System board
Unreadable LCD screen Missing pels in characters Abnormal screen Wrong color displayed	Reconnect the LCD connector LCD inverter ID LCD cable LCD inverter LCD System board
LCD has extra horizontal or vertical lines displayed.	LCD inverter ID LCD inverter LCD cable LCD System board

Indicator-Related Symptoms

Symptom / Error	Action in Sequence
Indicator incorrectly remains off or on, but system runs correctly	Reconnect the inverter board Inverter board System board

Power-Related Symptoms

Symptom / Error	Action in Sequence
Power shuts down during operation	Power source (battery pack and power adapter). See "Power System Check" on page 81. Battery pack Power adapter Hard drive & battery connection board System board
The system doesn't power-on.	Power source (battery pack and power adapter). See "Power System Check" on page 81. Battery pack Power adapter Hard drive & battery connection board System board
The system doesn't power-off.	Power source (battery pack and power adapter). See "Power System Check" on page 81. Hold and press the power switch for more than 4 seconds. System board

Power-Related Symptoms

Symptom / Error	Action in Sequence
Battery can't be charged	See "Check the Battery Pack" on page 83. Battery pack System board

PCMCIA-Related Symptoms

Symptom / Error	Action in Sequence
System cannot detect the PC Card (PCMCIA)	PCMCIA slot assembly System board
PCMCIA slot pin is damaged.	PCMCIA slot assembly

Memory-Related Symptoms

Symptom / Error	Action in Sequence
Memory count (size) appears different from actual size.	Enter BIOS Setup Utility to execute "Load Default Settings, then reboot system. DIMM System board

Speaker-Related Symptoms

Symptom / Error	Action in Sequence
In Windows, multimedia programs, no sound comes from the computer.	Audio driver Speaker System board
Internal speakers make noise or emit no sound.	Speaker System board

Power Management-Related Symptoms

Symptom / Error	Action in Sequence
The system will not enter hibernation	See "Save to Disk (S4)" on page 45. Keyboard (if control is from the keyboard) Hard disk drive System board
The system doesn't enter hibernation mode and four short beeps every minute.	Press Fn+  and see if the computer enters hibernation mode. Touchpad Keyboard Hard disk connection board Hard disk drive System board
The system doesn't enter standby mode after closing the LCD	See "Save to Disk (S4)" on page 45. LCD cover switch System board
The system doesn't resume from hibernation mode.	See "Save to Disk (S4)" on page 45. Hard disk connection board Hard disk drive System board
The system doesn't resume from standby mode after opening the LCD.	See "Save to Disk (S4)" on page 45. LCD cover switch System board

Power Management-Related Symptoms

Symptom / Error	Action in Sequence
Battery fuel gauge in Windows doesn't go higher than 90%.	Remove battery pack and let it cool for 2 hours. Refresh battery (continue use battery until power off, then charge battery). Battery pack System board
System hangs intermittently.	Reconnect hard disk/CD-ROM drives. Hard disk connection board System board

Peripheral-Related Symptoms

Symptom / Error	Action in Sequence
System configuration does not match the installed devices.	Enter BIOS Setup Utility to execute "Load Default Settings", then reboot system. Reconnect hard disk/CD-ROM/diskette drives.
External display does not work correctly.	Press Fn+F5, LCD/CRT/Both display switching System board
USB does not work correctly	System board
Print problems.	Ensure the "Parallel Port" in the "Onboard Devices Configuration" of BIOS Setup Utility is set to Enabled. Onboard Devices Configuration Run printer self-test. Printer driver Printer cable Printer System Board
Serial or parallel port device problems.	Ensure the "Serial Port" in the Devices Configuration" of BIOS Setup Utility is set to Enabled. Device driver Device cable Device System board

Keyboard/Touchpad-Related Symptoms

Symptom / Error	Action in Sequence
Keyboard (one or more keys) does not work.	Reconnect the keyboard cable. Keyboard System board
Touchpad does not work.	Reconnect touchpad cable. Touchpad board System board

Modem-Related Symptoms

Symptom / Error	Action in Sequence
Internal modem does not work correctly.	Modem phone port modem combo board System board

NOTE: If you cannot find a symptom or an error in this list and the problem remains, see "Undetermined Problems" on page 96.

Intermittent Problems

Intermittent system hang problems can be caused by a variety of reasons that have nothing to do with a hardware defect, such as: cosmic radiation, electrostatic discharge, or software errors. FRU replacement should be considered only when a recurring problem exists.

When analyzing an intermittent problem, do the following:

1. Run the advanced diagnostic test for the system board in loop mode at least 10 times.
2. If no error is detected, do not replace any FRU.
3. If any error is detected, replace the FRU. Rerun the test to verify that there are no more errors.

Undetermined Problems

The diagnostic problems does not identify which adapter or device failed, which installed devices are incorrect, whether a short circuit is suspected, or whether the system is inoperative.

Follow these procedures to isolate the failing FRU (do not isolate non-defective FRU).

NOTE: Verify that all attached devices are supported by the computer.

NOTE: Verify that the power supply being used at the time of the failure is operating correctly. (See "Power System Check" on page 81.):

1. Power-off the computer.
2. Visually check them for damage. If any problems are found, replace the FRU.
3. Remove or disconnect all of the following devices:
 - Non-Acer devices
 - Printer, mouse, and other external devices
 - Battery pack
 - Hard disk drive
 - DIMM
 - CD-ROM/Diskette drive Module
 - PC Cards
4. Power-on the computer.
5. Determine if the problem has changed.
6. If the problem does not recur, reconnect the removed devices one at a time until you find the failing FRU.
7. If the problem remains, replace the following FRU one at a time. Do not replace a non-defective FRU:
 - System board
 - LCD assembly

Jumper and Connector Locations

Top View

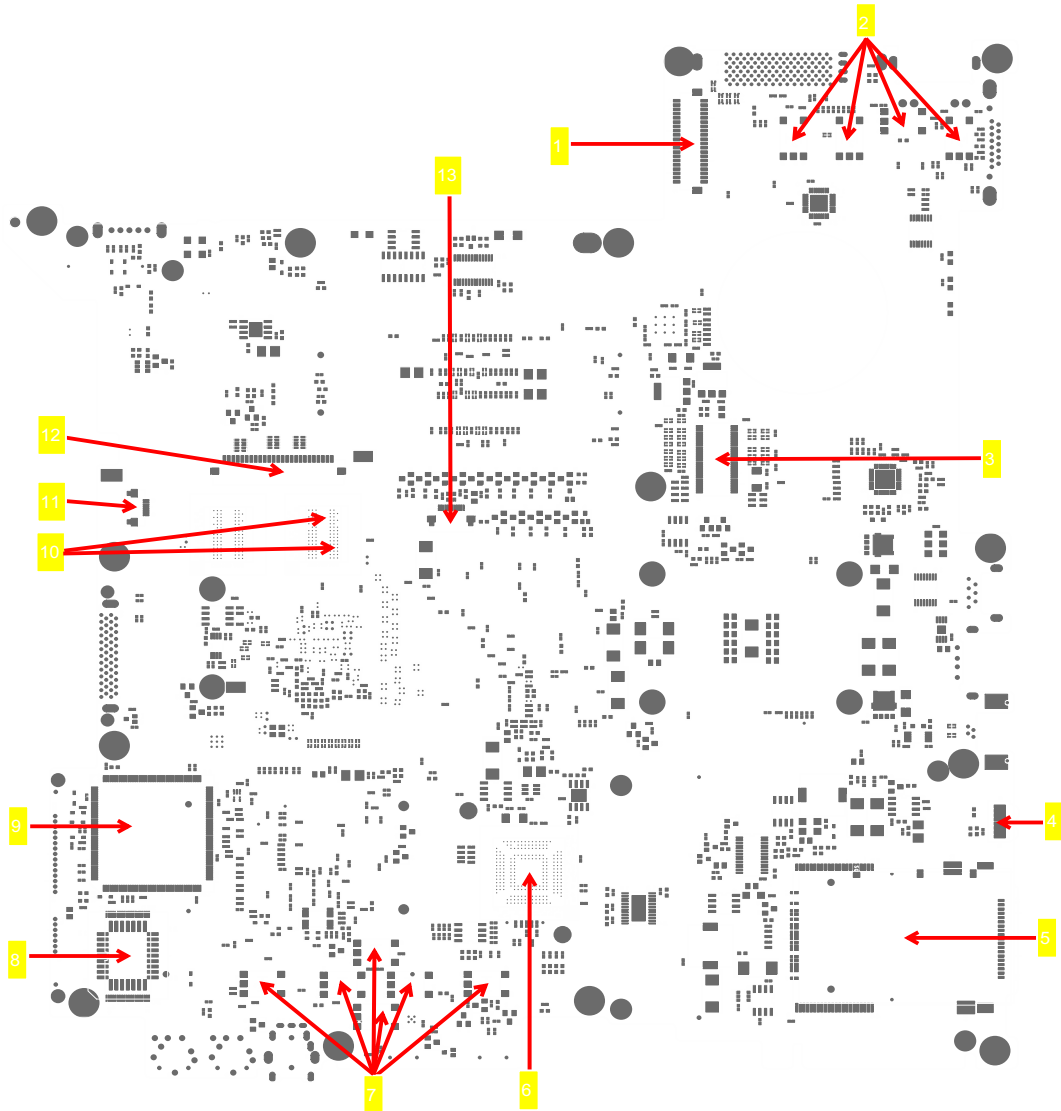

1	CN1	LVDS CONN	8	U18	BIOS
2	SW1-4	QUICK KEY SWITCH	9	U13	KB CONTROLLER (87541V)
3	U3	LCOCK GENERATOR	10	U5-6	G72M-VRAM
4	U12	FIR	11	CN3	MEDIA CONN
5	CN5-6	5-IN-1 MMC/SD/MS/MS Pro/xD CARD READER CONN	12	CN2	K/B CONN
6	U14	PCI8412/6412	13	CN4	TP/B CONN
7	SW5-10	T/P SWITCH			

Bottom View

NOTE: This is engineering sample. The image above may not be exactly the same as the real main board you get.

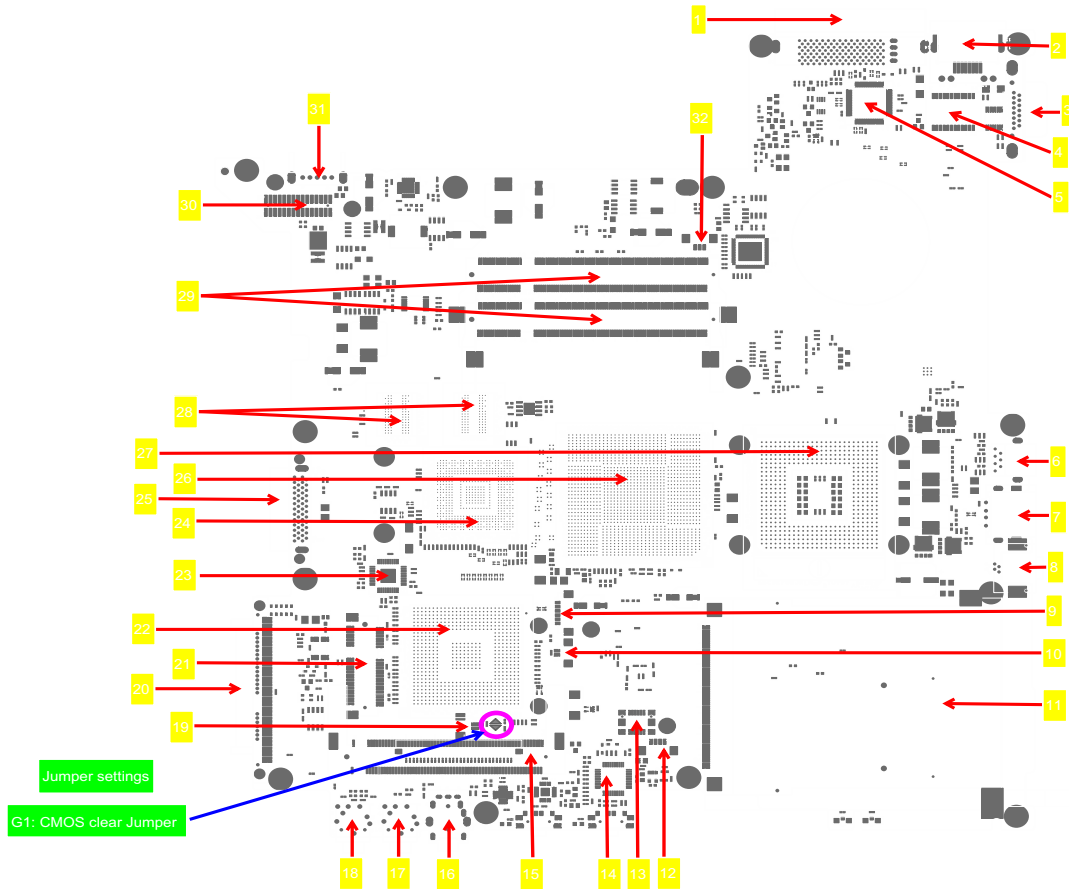

1	CN9	DOCKING	17	CN30	MIC CONN
2	CN8	RJ45 CONN	18	CN29	LINE-IN CONN
3	CN10	CRT CONN	19	CN25	RTC CONN
4	U21	LAN TRANSFORMER	20	CN22	HDD CONN
5	U20	SUPER I/O NS87383	21	CN21	MIMI CARD
6	CN15	S-VIDEO CONN	22	U35	South Bridge ICH7M
7	CN17	USB CONN	23	U34	DVO CHRONTEL-CH7307
8	CN18	1394 CONN	24	U30	NVIDIA-G72M
9	CN19	BLUETOOTH CONN	25	CN16	ODD CONN
10	CN20	INTERNAL MIC CONN	26	U31	NB 945GM/PM & 940GML
11	CN23	PCMCIA SLOT	27	U32	CPU-Yonah/Merom
12	CN7	INTERNAL SPEAKER CONN	28	U28-29	G72M-VRAM
13	CN24	MDC CONN	29	CN13-14	SODIMM CONN
14	U42	AUDIO CODEC ALLC883	30	CN11	POWER BOARD CONN
15	CN27	MIMI PCI CONN	31	PJ1	BATTERY CONN
16	CN28	HP OUT CONN	32	CN12	FAN CONN

Jumper Settings/Clear BIOS Password Procedures

1. Please see the bottom side of the main board.
2. Find G1 jumper and short the jumper to clear BIOS password.

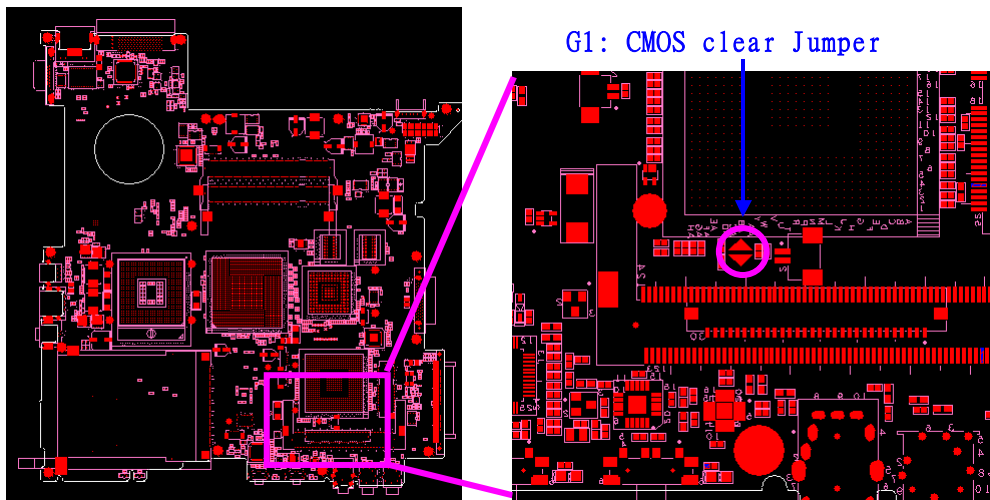

FRU (Field Replaceable Unit) List

This chapter gives you the FRU (Field Replaceable Unit) listing in global configurations of Aspire 3680/5570/5580. Refer to this chapter whenever ordering for parts to repair or for RMA (Return Merchandise Authorization).

Please note that WHEN ORDERING FRU PARTS, you should check the most up-to-date information available on your regional web or channel. For whatever reasons a part number change is made, it will not be noted on the printed Service Guide. For ACER AUTHORIZED SERVICE PROVIDERS, your Acer office may have a DIFFERENT part number code from those given in the FRU list of this printed Service Guide. You MUST use the local FRU list provided by your regional Acer office to order FRU parts for repair and service of customer machines.

NOTE: To scrap or to return the defective parts, you should follow the local government ordinance or regulations on how to dispose it properly, or follow the rules set by your regional Acer office on how to return it.

Aspire 3680/5570/5580 Exploded Diagram

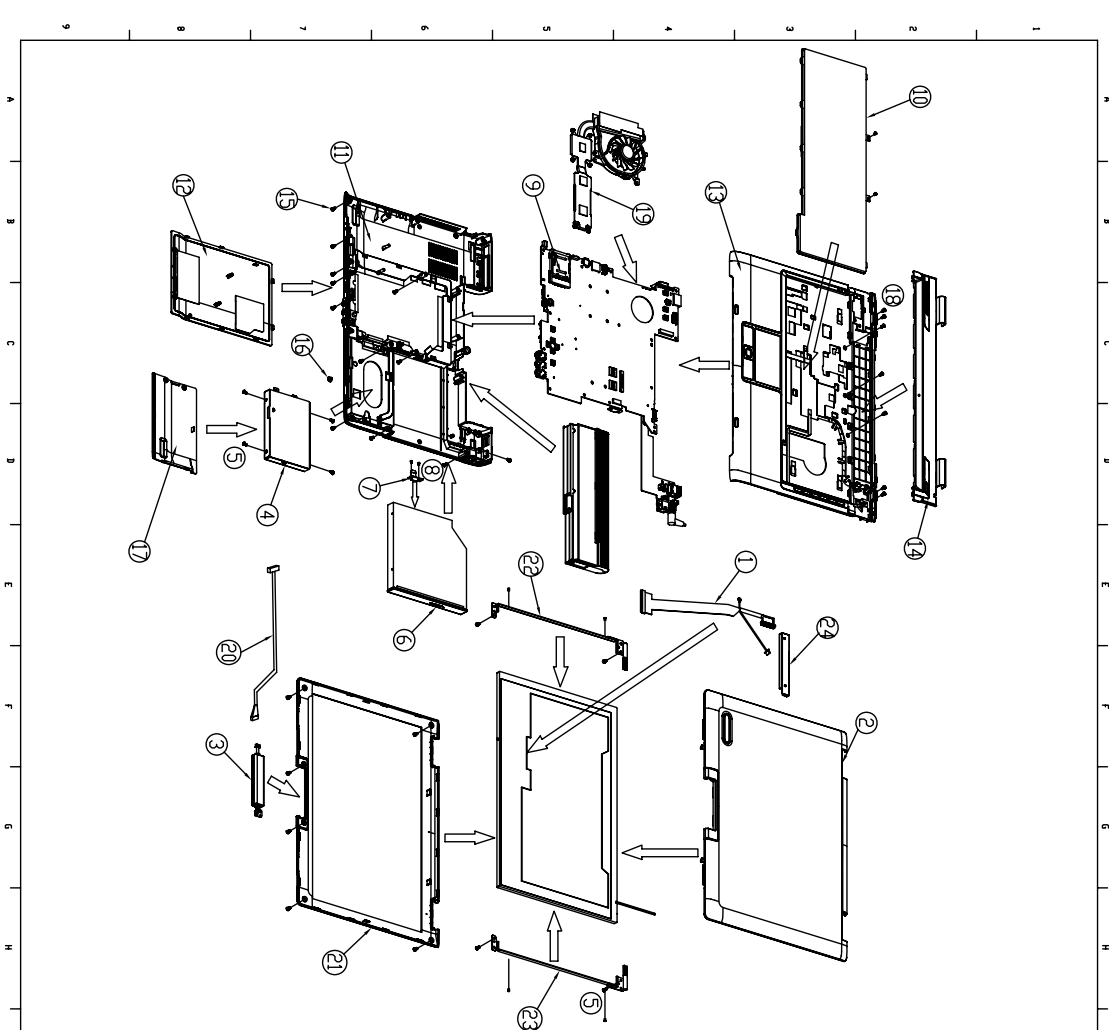

no.	pn	description	qty
1	DD0ZRLTC008	CABLE ASSY ZR1 14.1" WXGA/G0/40/5P1.4	1
2	3DZRLICTN32	ZR1 14W LCD COVER AS W/CCD ASSY	1
3	3HZRICDTN01	ZR1 CCD 1.3-MEGA ME MODULE ASSY	1
4	3SZR1HBTN01	ZR1 HDD BRACKET ASSY	1
5	MS300351354	SCREW M3*0.5+3.5L	4
6	3HZBICRTN12	ZR1 ODD BEZEL ASSY G/B SUPER MULTI	1
7	FBZR1007017	ODD BKT ZR1(FBZR1007/REV3A)	1
8	MM200300C13	SCREW M2.0*3.0+1.1N-NYLOK	2
9	31ZRIIMB00G5	ZR1 MB (G721I28/PAT A/FW/O CPU) ASSY	1
10	MM250300L65	SCREW M2.5*3.0-(BND/NYLOK)/EP	2
11	36ZRI BATTN17	ZR1 BATTERY ASSY W/O DOCKING	1
12	37ZRI RCTN03	ZR1 RAM COVER ASSY	1
13	39ZRI I TATN11	ZR1 AS TOP W/HEIDI/A1/394/5 IN V/FIR ASS	1
14	3AZRI RCTN01	ZR1 K/B COVER-AS ASSY	1
15	MM250601L69	SCREW M2.5*6-(BND/NYLOK)	23
16	MS250201H05	SCREW M2.5*2.1 (N1,NYLOK)	1
17	38ZRI HCTN09	ZR1 HDD COVER ASSY	1
18	MM250601C15	SCREW M2.5*6.0-P/N(DN/NYLOK)	4
19	34ZRI I TATN09	ZR1 THERMAL MODULE ASSY AVC	1
20	DD0ZRI I TH008	CABLE ASSY ZR1 BULB FOOT/HTH(6P/8P) R/L	1
21	3EZRI I L BTN03	ZR1 14W LCD BEZEL ASSY W/CCD	1
22	3BZRI I HATN02	ZR1 14" HINGE-L ASSY JAR	1
23	3CZRI I HATN03	ZR1 14" HINGE-R ASSY JAR	1
24	AS0231701H0	INV ZR1 (8-20V V/O=700) TWS-449-277	1





ITEM	REV. NO.	DESCRIPTION	DATE
1			

DATE	BY	CHKD	APP
07/27/06	REV 3M		

NOTE: The FRU List is not for Aspire 3680/5570/5580. The FRU list for Aspire 3680/5570/5580 is not ready as the service guide released. We will update the FRU list as soon as we got the latest FRU list.

Aspire 3680/5570/5580 FRU List

Category	No.	Part Name and Description	Acer Part No.
Adapter			
		ADAPTER 65W DELTA SADP-65KB DBE	AP.06501.007
		ADAPTER 65W LITEON PA-1650-02WR	AP.06503.011
		ADAPTER 65W LISHIN SLS0335A19A54LF	AP.06506.003
Battery			
		BATTERY PACK LI 6CELL 2.0MAH SANYO	BT.00603.014
		BATTERY PACK LI+ 6CELL 2.0MAH SONY	BT.00604.006
		BATTERY PACK LI 6CELL 2.0MAH PANASONIC	BT.00605.002
		BATTERY PACK LI+ 6CELL 2.4MAH SANYO	BT.00603.012
		BATTERY PACK LI+ 6CELL 2.4MAH SONY	BT.00604.005
		BATTERY PACK LI+ 6CELL 2.4MAH PANASONIC	BT.00605.003
		BATTERY PACK LI+ 9CELL 2.4MAH SANYO	BT.00903.004
Boards			
		WIRELESS LAN BOARD 802.11BG FOXCONN ATHEROS EU	54.A74V1.001
		WIRELESS LAN BOARD 802.11BG FOXCONN BCM4318	54.A74V1.002
		MODEM BOARD FOXCONN T60M845.01	54.TCZV1.001
		TOUCHPAD BOARD SYNAPTICS TM51-389	56.TB1V1.001
		LED BOARD	55.TCZV1.001

Category	No.	Part Name and Description	Acer Part No.
		BLUETOOTH MODULE FOXCONN BCM2045 Note: The bluetooth module does not contain the black mylar as the image shows..	54.TB2V1.001
		BT MODULE FOXCONN BCM2045 V00	54.A74V1.003
Cables			
		MODEM CABLE	50.TCZV1.006
		LED CABLE	50.TCZV1.001
		TOUCHPAD CABLE	50.TCZV1.002
		BLUETOOTH CABLE	50.TCZV1.003
		POWER CORD 2.5A 125V USA	27.01518.781
		POWER CORD 10A 250V 3PIN CHINA	27.01518.591
		POWER CORD 10A 125V US	27.T30V1.001
		POWER CORD 7A 250V 2PIN KOREAN	27.01518.531
		POWER CORD 3A 250V 3PIN UK	27.01518.541
		POWER CORD 220V 3PIN EUR	27.T30V1.004
		POWER CORD 7A 125V 2PIN JAPEN	27.01518.551
		POWER CORD 10A 3PIN BK	27.01518.561
		POWER CORD 10A 250V 3PIN ITALY	27.01518.611
		POWER CORD 10A 250V 3PIN BK SOUTH AFRICA	27.01518.571
		POWER CORD 10A 250V SWISS	27.01518.581
		POWER CORD 2.5A 250V AUSTRALIA	27.01518.621
		POWER CORD 2.5A 250V SOUTH AFRICA BK	27.01518.631
		POWER CODE 7A 125V JAPAN 2PIN	27.03518.161
Case/Cover/Bracket/Assembly			

Category	No.	Part Name and Description	Acer Part No.
		LOWERCASE W/SPEAKER	60.TCZV1.001
Speaker			
		SPEAKER	23.TCZV1.003
Case/Cover/Bracket/Assembly			
		MIDDLE COVER W/MICROPHONE (TRAVELMATE)	60.TCZV1.003
		MIDDLE COVER W/MICROPHONE (ASPIRE)	60.ADKV1.003
		FRONT COVER	42.TCZV1.003
		DIMM COVER	42.TCZV1.002
		HDD COVER	42.TCZV1.001
		TOUCHPAD BRACKET	33.TCZV1.001
		UPPER CASE (TRAVELMATE)	60.TCZV1.002
		UPPER CASE (ASPIRE)	60.ADKV1.002
Combo Module			





Category	No.	Part Name and Description	Acer Part No.
		COMBO MODULE 24X	6M.TB2V1.001
		OPTICAL FIX HOLDER BRACKET	33.TB2V1.002
		OPTICAL RAIL HOLDER	33.TB2V1.003
		OPTICAL BEZEL GBASE FOR COMBO	42.TB2V1.003
		COMBO MODULE 24X HLDS GCC-4244N LF 1.00AB W/O BEZEL	KO.0240A.005
		COMBO MODULE 24X LITEON SOS-2485K W/O BEZEL	KO.02409.015
CPU/Processor			
		CPU CEL-M370 1.5GMHZ INTEL	KC.NV001.370
		CPU DOTHAN730 1.6GMHZ INTEL	KC.N0001.730
		CPU DOTHAN740 1.73GMHZ INTEL	KC.N0001.740
		CPU DOTHAN725A 1.6GMHZ INTEL	KC.NA001.725
		CPU CEL-M370 1.5G MHZ INTEL	KC.NC001.370
		CPU CEL-M380 1.6GMHZ INTEL	KC.NV001.380
		CPU CEL-M390 1.7GMHZ INTEL	KC.NV001.390
		CPU CEL-M360 1.4GMHZ INTEL	KC.NV001.360
DVD Module			
		DVD-RW MODULE 8X	6M.TB2V1.002



Category	No.	Part Name and Description	Acer Part No.
		OPTICAL FIX HOLDER BRACKET	33.TB2V1.002
		OPTICAL RAIL HOLDER	33.TB2V1.003
		OPTICAL BEZEL GBASE FOR DUAL	42.TB2V1.003 42.TB2V1.004 (TM)
		DVD-RW DRIVE 8X S-MUTI HLDS GSA-4082N W/O BEZEL	KU.0080D.017
		DVD-RW DRIVE 8X DUAL LITEON SOSW-833S W/O BEZEL	KU.00804.012
		DUAL PIO/DVR-K16RA AG1 NOBZ LF	KU.00805.019
		DUAL PAN/UJ-850 AG1 NOBZL LF	KU.00807.022
		DUAL HLD/GWA-4082N MORAR GCP03	KU.0080D.019
		S-MUTI PAN/UJ-850 AG1 NOBZL LF	KU.00807.025
Fan			
		FAN SUNON AG1	23.TB2V1.003
HDD/Hard Disk Drive			
		HDD MODULE 40G	TBD
		ASSY HDD BRACKET AG1	33.TB2V1.004
		HDD 40GB SEAGATE ST9402112A	KH.04001.014
		HDD 40GB TOSHIBA MK4025GAS	KH.04004.005
		HDD 40GB HGST HTS421240H9AT00	KH.04007.013
		HDD 40GB WD WD400UE-22HCT0	KH.04008.025
		HDD 40GB SAMSUNG M40MP0402H	KH.0400B.003
		HDD MODULE 60G	TBD
		ASSY HDD BRACKET AG1	33.TB2V1.004

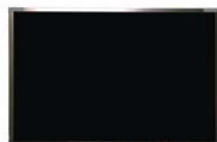

Category	No.	Part Name and Description	Acer Part No.
		HDD 60GB SEAGATE ST96812A	KH.06001.004
		HDD 60GB SEAGATE ST960812A	KH.06001.003
		HDD 60GB TOSHIBA MK6025GAS	KH.06004.004
		HDD 60G TOSHIBA	KH.06004.007
		HDD 60GB HGST HTS541260H9AT00	KH.06007.010
		HDD 60GB WD WD600UE-22HCT0	KH.06008.002
		HDD MODULE 80G	TBD
		HDD BRACKET	33.TB2V1.004
		HDD 80G TOSHIBA MK8025GAS	KH.08004.003
		HDD 80G HITACHI HTS421280H9AT00	KH.08007.011
		HDD 80G SEAGATE ST980829A	KH.08001.013
		HDD 80G SEAGATE ST98823A	KH.08001.014
		HDD 80G TOSHIBA MK8026GAX	KH.08004.004
		HDD 80G HGST HTS541280H9AT00	KH.08007.012
		HDD 80G WD WD800UE-22HCT0	KH.08008.027
		HDD MODULE 100G	TBD
		HDD BRACKET	33.TB2V1.004
		HDD 100GB SEAGATE ST9100825A	KH.10001.003
		HDD 100G TOSHIBA MK1031GAS	KH.10004.001
		HDD 100G HITACHI HTS421210H9AT00	KH.10007.002
		HDD 100G SEAGATE ST9100824A	KH.10001.004
		HDD 100G SATA SAMSUNG HM100JI	KH.1000B.001
		HDD MODULE 120G	TBD
		HDD BRACKET	33.TB2V1.004
		HDD 120G SEAGATE ST9120824A	KH.12001.014
		HDD 120G SEAGATE ST9120821A	KH.12001.015
Heatsink			
		CPU HEATSINK W/SCREW W/O FAN	34.TB2V1.001
Keyboard			
		KEYBOARD 89KEY DARFON NSK- H3M00 SWISS	KB.A2707.011
		KEYBOARD 88KEY DARFON NSK- H30M02 TAIWAN(CHINESE)	KB.A2707.002
		KEYBOARD 88KEY DARFON NSK- H3M03 THAI	KB.A2707.004

Category	No.	Part Name and Description	Acer Part No.
		KEYBOARD 89KEY DARFON NSK-H3M06 PORTUGA	KB.A2707.012
		KEYBOARD 88KEY DARFON NSK-H3M0A ARABIA	KB.A2707.013
		KEYBOARD 89KEY DARFON NSK-H3M0C CZECH	KB.A2707.016
		KEYBOARD 89KEY DARFON NSK-H3M0D DANISH	KB.A2707.019
		KEYBOARD 89KEY NSK-H3M0E DARFON ITALY	KB.A2707.009
		KEYBOARD 89KEY DARFON NSK-H3M0F FRENCH	KB.A2707.010
		KEYBOARD 89KEY DARFON NSK-H3M0G GERMAN	KB.A2707.008
		KEYBOARD 88KEY DARFON NSK-H3M0H HB	KB.A2707.024
		KEYBOARD 88KEY DARFON NSK-H3M0L GK	KB.A2707.023
		KEYBOARD 89KEY DARFON NSK-H3M0M CF	KB.A2707.021
		KEYBOARD 89KEY DARFON NSK-H3M0N NORWEGIAN	KB.A2707.018
		KEYBOARD 89KEY DARFON NSK-H3M0Q HG	KB.A2707.017
		KEYBOARD 88KEY DARFON NSK-H3M0R RUSSIAN	KB.A2707.025
		KEYBOARD 89KEY DARFON NSK-H3M0S SP	KB.A2707.003
		KEYBOARD 89KEY DARFON NSK-H3M0T TURKISH	KB.A2707.020
		KEYBOARD 89KEY DARFON NSK-H3M0U UK	KB.A2707.007
		KEYBOARD 89KEY DARFON NSK-H3M0W SWEDEN	KB.A2707.015
		KEYBOARD 89KEY DARFON NSK-H3M1A BELGIUM	KB.A2707.014
		KEYBOARD 89KEY DARFON NSK-H3M1B BR	KB.A2707.005
		KEYBOARD 88KEY DARFON NSK-H3M1D US-INTERNATIONAL	KB.A2707.001
Keyboard (TM)			
		KEYBOARD 89KEY DARFON NSK-AEK00 SWISS	KB.T5007.011
		KEYBOARD 88KEY DARFON NSK-AEK02 TAIWAN(CHINESE)	KB.T5007.002
		KEYBOARD 88KEY DARFON NSK-AEK03 THAI	KB.T5007.004
		KEYBOARD 89KEY DARFON NSK-AEK06 PORTUGA	KB.T5007.012
		KEYBOARD 88KEY DARFON NSK-AEK0A ARABIC	KB.T5007.013
		KEYBOARD 89KEY DARFON NSK-AEK0C CZECH	KB.T5007.016

Category	No.	Part Name and Description	Acer Part No.
		KEYBOARD 89KEY DARFON NSK-AEK0D DANISH	KB.T5007.019
		KEYBOARD 89KEY DARFON NSK-AEK0E ITALY	KB.T5007.009
		KEYBOARD 89KEY DARFON NSK-AEK0F FRENCH	KB.T5007.010
		KEYBOARD 88KEY DARFON NSK-AEK0G GERMAN	KB.T5007.008
		KEYBOARD 88KEY DARFON NSK-AEK0H HB	KB.T5007.024
		KEYBOARD 88KEY DARFON NSK-AEK0L GK	KB.T5007.023
		KEYBOARD 89KEY DARFON NSK-AEK0M CF	KB.T5007.021
		KEYBOARD 89KEY DARFON NSK-AEK0N NORWEGIAN	KB.T5007.018
		KEYBOARD 89KEY DARFON NSK-AEK0Q HG	KB.T5007.017
		KEYBOARD 88KEY DARFON NSK-AEK0R RUSSIAN	KB.T5007.025
		KEYBOARD 89KEY DARFON NSK-AEK0S SP	KB.T5007.003
		KEYBOARD 89KEY DARFON NSK-AEK0T TURKISH	KB.T5007.020
		KEYBOARD 89KEY DARFON NSK-AEK0U UK	KB.T5007.007
		KEYBOARD 89KEY DARFON NSK-AEK0W SWEDEN	KB.T5007.015
		KEYBOARD 89KEY DARFON NSK-AEK1A BELGIUM	KB.T5007.014
		KEYBOARD 89KEY DARFON NSK-AEK1B BR	KB.T5007.005
		KEYBOARD DARFON NSK-N7082 US-INTERNATIONAL	KB.T5007.001
		KEYBOARD 89KEY DARFON NSK-AEK1F SV	KB.T5007.026
LCD Module			
		LCD MODULE CCD 14.1" WXGA GLARE W/ANTENNA	6M.ADKV1.021(Aspire)
		LCD MODULE 14.1" WXGA NONE GLARE W/ANTENNA	6M.ADKV1.011(Aspire) 6M.TCZV1.011(TravelMate) 6M.TCZV1.012(TravelMate)
		INVERTER BOARD DARFON VK.21189.402	19.TCBV1.001
		INVERTER BOARD 15.4" FOXCONN T62I240.00	19.A46V1.003
		INVERTER BOARD 15.4" YEC YNV-W02	19.TB2V1.001

Category	No.	Part Name and Description	Acer Part No.
		WIRELESS ANTENNA LEFT/RIGHT	25.TCZV1.001
		LCD/INVERTER CABLE 14.1" WXGA	50.TCZV1.004
		LCD BRACKET RIGHT Note: Right bracket is the upper one.	33.TB1V1.003
		LCD BRACKET LEFT Note: Left bracket is the lower one	33.TB1V1.004
		LCD PANEL 14.1" W/HINGE	60.AA6V1.004(Aspire) 60.TB2V1.004(TravelMate) 60.TCZV1.005(TravelMate)
		LCD BEZEL 14.1" W/LOGO	60.TB2V1.005
		HINGE PACK LEFT/RIGHT	6K.TB2V1.001
		LCD 14.1" WXGA AU B141EW01 V.1 NONE GLARE	LK.14105.013
		LCD 14" WXGA SAMSUNG LTN141W1-L01 NONE GLARE	LK.14106.004
		LCD 14.1" WXGA LG LP141WX1- TL02 NONE GLARE	LK.14108.002
		LCD 14.1" WXGA QDI QD14TL01-03 NONE GLARE 420G	LK.14109.004
		LCD 14" WXGA CMO N141I1-L02 NONE GLARE	LK.1410D.004
		LCD MODULE 14.1" WXGA GLARE W/ANTENNA	6M.TB2V1.012
		INVERTER BOARD 15.4" FOXCONN T62I240.00	19.A46V1.003
		WIRELESS ANTENNA LEFT/RIGHT	25.TB2V1.001
		LCD/INVERTER CABLE 14.1" WXGA	50.TB2V1.007

Category	No.	Part Name and Description	Acer Part No.
		LCD BRACKET RIGHT	33.TB1V1.003
		LCD BRACKET LEFT	33.TB1V1.004
		LCD PANEL 14.1" W/HINGE	60.TB2V1.004
		LCD BEZEL 14.1" W/LOGO	60.TB2V1.005
		HINGE PACK LEFT/RIGHT	6K.TB2V1.001
		LCD 14.1" WXGA CMO N14111-L03 GLARE	LK.1410D.005
		LCD 14.1" WXGA QDI QD14TL01-02 GLARE 420G	LK.14109.005
		LCD 14.1" WXGA AU B141EW01 V.0 GLARE TYPE	LK.14105.014
		LCD 14.1" WXGA SAMSUNG LTN141W1-L01 GLARE	LK.14106.005
		LCD 14.1" WXGA LG LP141WX1- TL03 GLARE	LK.14108.003
Mainboard			
		MAINBOARD AG1910 W/O CPU W/ PCMCIA SLOT & RTC BATTERY	MB.TCZV1.001
Battery			
		RTC BATTERY	23.TCZV1.004
PCMCIA Slot/PC Card Slot			
		PCMCIA SLOY	22.TB2V1.001
Memory			
		SDIMM 256M INFINEON HYS64T32000HDL-3.7-A	KN.25602.023
		DIMM 256M NANYA NT256T64UH4A1FN-37B	KN.25603.029
		SDIMM 256M MICRON MT4HTF3264HY-53EB3	KN.25604.027
		SDIMM 256M SAMSUNG M470T3354CZ3-CD5	KN.2560B.017
		SDIMM 256M HYNIX HYMP532S64P6-C4	KN.2560G.006
		SDIMM 512M INFINEON MHYS64T64020HDL-3.7-A	KN.51202.021
		SDIMM 512M NANYA NT512T64UH8A1FN-37B	KN.51203.023
		SDIMM 512M MICRON MT8HTF6464HDY-53EB3	KN.51204.019
		SDIMM 512M SAMSUNG M470T6554CZ3-CD5	KN.5120B.015
		SDIMM 512M HYNIX HYMP564S64P6-C4	KN.5120G.005
Miscellaneous			

Category	No.	Part Name and Description	Acer Part No.
		LCD SCREW RUBBER LCD RUBBER CUSHION	47.A46V1.002
		LCD SCREW RUBBER	47.TB1V1.001
		NAME PLATE	40.ADKV1.001
		NAME PLIATE (TM)	40.TCZV1.001
Screws			
		SCW HEX NYL I#R-40/O#4-40 L5.5	34.00015.081
		SCREW MACH WAFER M2*L4 NI	86.00059.220
		SCRW M2*L3 BLACK	86.00C31.220
		SCRW M2 X 2	86.00C34.620
		SCR M2.5*12L B-ZN NYLOK I-HEAD	86.5A353.120
		SCREW M2.5-6	86.9A323.6R0
		WCH MSN+CBZ SCREW M2X2.5	86.9A352.2R5
		SCREW M2*3 NYLON 1JMCPC-420325	86.9A352.3R0
		SCREW	86.9A352.4R0
		SCREW M2.5*4L(NYLOCK)BLACK ZN	86.9A353.4R0
		SRW M2.5*8L B/ZN NYLOK 700	86.9A353.8R0
		SCREW M3x4(86.9A524.4R0)	86.9A524.4R0
		SCREW WAFER NYLOK NI 2ML3	86.9A552.3R0
		SCRW M2*4 WAFER NI	86.9A552.4R0
		SCRW M2.5*3 WAFER NI	86.9A553.3R0
		SCREW NYLOK M2.5-5	86.9A553.5R0
		SCREW M2.5*L3	86.00E08.223
Microphone			
		MICROPHONE	23.TCZV1.002

Model Definition and Configuration

Aspire 3680 Series

Model	RO	Country	Acer Part no	Description	CPU	Memory	HDD 1 (GB)	ODD
AS3681W XCi	TWN	GCTWN	S2.AEP05.001	AS3681WXCi XPHTC1 UMA 2*512/ 40/BT/6L/5R/ CB_bg_AN	CM410	SO512M BII5	N40GB4. 2K	NCB24X
AS3682W XCi	EMEA	South Africa	LX.AEP05.017	AS3682WXCi XPHSA1 UMA 1*256/ 40/6L/ 5R_bg_AN	CM420	SO256M BII5	N40GB4. 2K	NCB24X
AS3682W XCi	EMEA	Denmark	LX.AEP05.005	AS3682WXCi XPHDK1 UMA 1*256/ 40/6L/ 5R_bg_AN	CM420	SO256M BII5	N40GB4. 2K	NCB24X
AS3682W XCi	EMEA	France	LX.AEP05.008	AS3682WXCi XPHFRA UMA 1*256/ 40/6L/ 5R_bg_AN	CM420	SO256M BII5	N40GB4. 2K	NCB24X
AS3682W XCi	EMEA	Germany	LX.AEP05.004	AS3682WXCi XPHDE7 UMA 1*256/ 40/6L/ 5R_bg_AN	CM420	SO256M BII5	N40GB4. 2K	NCB24X
AS3682W XCi	EMEA	Belgium	LX.AEP05.002	AS3682WXCi XPHBE1 UMA 1*256/ 40/6L/ 5R_bg_AN	CM420	SO256M BII5	N40GB4. 2K	NCB24X
AS3682W XCi	EMEA	Holland	LX.AEP05.012	AS3682WXCi XPHNL1 UMA 1*256/ 40/6L/ 5R_bg_AN	CM420	SO256M BII5	N40GB4. 2K	NCB24X
AS3682W XCi	EMEA	Norway	LX.AEP05.013	AS3682WXCi XPHNO1 UMA 1*256/ 40/6L/ 5R_bg_AN	CM420	SO256M BII5	N40GB4. 2K	NCB24X
AS3682W XCi	EMEA	Russia	LX.AEP05.016	AS3682WXCi XPHRU2 UMA 1*256/ 40/6L/ 5R_bg_AN	CM420	SO256M BII5	N40GB4. 2K	NCB24X

Model	RO	Country	Acer Part no	Description	CPU	Memory	HDD 1 (GB)	ODD
AS3682W XCi	EMEA	Sweden/ Finland	LX.AEP05.019	AS3682WXCi XPHSV1 UMA 1*256/ 40/6L/ 5R_bg_AN	CM420	SO256M BII5	N40GB4. 2K	NCB24X
AS3682W XCi	EMEA	Eastern Europe	LX.AEP05.003	AS3682WXCi XPHCS2 UMA 1*256/ 40/6L/ 5R_bg_AN	CM420	SO256M BII5	N40GB4. 2K	NCB24X
AS3682W XCi	EMEA	Eastern Europe	LX.AEP05.009	AS3682WXCi XPHHU6 UMA 1*256/ 40/6L/ 5R_bg_AN	CM420	SO256M BII5	N40GB4. 2K	NCB24X
AS3682W XCi	EMEA	Eastern Europe	LX.AEP05.014	AS3682WXCi XPHPL6 UMA 1*256/40/6L/ 5R_bg_AN	CM420	SO256M BII5	N40GB4. 2K	NCB24X
AS3682W XCi	EMEA	Slovenia/ Croatia	LX.AEP05.018	AS3682WXCi XPHSLO2 UMA 1*256/ 40/6L/ 5R_bg_AN	CM420	SO256M BII5	N40GB4. 2K	NCB24X
AS3682W XCi	EMEA	Spain	LX.AEP05.007	AS3682WXCi XPHESA UMA 1*256/ 40/6L/ 5R_bg_AN	CM420	SO256M BII5	N40GB4. 2K	NCB24X
AS3682W XCi	EMEA	Portugal	LX.AEP05.015	AS3682WXCi XPHPT1 UMA 1*256/ 40/6L/ 5R_bg_AN	CM420	SO256M BII5	N40GB4. 2K	NCB24X
AS3682W XCi	EMEA	Greece	LX.AEP05.006	AS3682WXCi XPHEL1 UMA 1*256/40/6L/ 5R_bg_AN	CM420	SO256M BII5	N40GB4. 2K	NCB24X
AS3682W XCi	EMEA	Israel	LX.AEP05.010	AS3682WXCi XPHIS1 UMA 1*256/40/6L/ 5R_bg_AN	CM420	SO256M BII5	N40GB4. 2K	NCB24X
AS3682W XCi	EMEA	Italy	LX.AEP05.011	AS3682WXCi XPHIT1 UMA 1*256/40/6L/ 5R_bg_AN	CM420	SO256M BII5	N40GB4. 2K	NCB24X
AS3682W XCi	EMEA	Turkey	LX.AEP05.021	AS3682WXCi XPHTR1 UMA 1*256/ 40/6L/ 5R_bg_AN	CM420	SO256M BII5	N40GB4. 2K	NCB24X
AS3682W XCi	EMEA	Middle East	LX.AEP05.001	AS3682WXCi XPHAR1 UMA 1*256/ 40/6L/ 5R_bg_AN	CM420	SO256M BII5	N40GB4. 2K	NCB24X

Model	RO	Country	Acer Part no	Description	CPU	Memory	HDD 1 (GB)	ODD
AS3682W XCi	EMEA	Switzerland	LX.AEP05.020	AS3682WXCi XPHSW5 UMA 1*256/ 40/6L/ 5R_bg_AN	CM420	SO256M BII5	N40GB4. 2K	NCB24X
AS3682W XCi	EMEA	UK	LX.AEP05.022	AS3682WXCi XPHUK1 UMA 1*256/ 40/6L/ 5R_bg_AN	CM420	SO256M BII5	N40GB4. 2K	NCB24X
AS3682W XCi	AAP	Australia/ New Zealand	LX.AEP05.023	AS3682WXCi XPHAU1 UMA 1*256/ 40/6L/ 5R_bg_AN	CM420	SO256M BII5	N40GB4. 2K	NCB24X
AS3682W XCi	AAP	Philippines	LX.AEP05.026	AS3682WXCi XPHPH1 UMA 1*256/ 40/6L/ 5R_bg_AN	CM420	SO256M BII5	N40GB4. 2K	NCB24X
AS3682W XCi	AAP	Malaysia	LX.AEP05.025	AS3682WXCi XPHMA2 UMA 1*256/ 40/6L/ 5R_bg_AN	CM420	SO256M BII5	N40GB4. 2K	NCB24X
AS3682W XCi	AAP	Thailand	LX.AEP05.027	AS3682WXCi XPTH2 UMA 1*256/ 40/6L/ 5R_bg_AN	CM420	SO256M BII5	N40GB4. 2K	NCB24X
AS3682W XCi	AAP	Vietnam	LX.AEP05.028	AS3682WXCi XPHVN1 UMA 1*256/ 40/6L/ 5R_bg_AN	CM420	SO256M BII5	N40GB4. 2K	NCB24X
AS3682W XCi	AAP	Singapore	LX.AEP05.029	AS3682WXCi XPHWSG21 W UMA 1*256/40/6L/ 5R_bg_AN	CM420	SO256M BII5	N40GB4. 2K	NCB24X
AS3682W XCi	AAP	Indonesia	LX.AEP05.024	AS3682WXCi XPHIN1 UMA 1*256/40/6L/ 5R_bg_AN	CM420	SO256M BII5	N40GB4. 2K	NCB24X
AS3682N WXCi	AAP	Singapore	LX.AEP0C.005	AS3682NWX Ci LINPUSSG1 UMA 1*256/ 40/6L/ 5R_bg_AN	CM420	SO256M BII5	N40GB4. 2K	NCB24X
AS3682N WXCi	AAP	India	LX.AEP0C.001	AS3682NWX Ci LINPUSIL1 UMA 1*256/ 40/6L/ 5R_bg_AN	CM420	SO256M BII5	N40GB4. 2K	NCB24X

Model	RO	Country	Acer Part no	Description	CPU	Memory	HDD 1 (GB)	ODD
AS3682N WXCi	AAP	Indonesia	LX.AEP0C.002	AS3682NWX Ci LINPUSIN1 UMA 1*256/ 40/6L/ 5R_bg_AN	CM420	SO256M BII5	N40GB4. 2K	NCB24X
AS3682N WXCi	AAP	Philippines	LX.AEP0C.004	AS3682NWX Ci LINPUSPH1 UMA 1*256/ 40/6L/ 5R_bg_AN	CM420	SO256M BII5	N40GB4. 2K	NCB24X
AS3682N WXCi	AAP	Malaysia	LX.AEP0C.003	AS3682NWX Ci LINPUSMA2 UMA 1*256/ 40/6L/ 5R_bg_AN	CM420	SO256M BII5	N40GB4. 2K	NCB24X
AS3682N WXCi	AAP	Thailand	LX.AEP0C.006	AS3682NWX Ci LINPUSH2 UMA 1*256/ 40/6L/ 5R_bg_AN	CM420	SO256M BII5	N40GB4. 2K	NCB24X
AS3682N WXCi	AAP	Vietnam	LX.AEP0C.007	AS3682NWX Ci LINPUSVN1 UMA 1*256/ 40/6L/ 5R_bg_AN	CM420	SO256M BII5	N40GB4. 2K	NCB24X
AS3682W XMi	AAP	Australia/ New Zealand	LX.AEP05.030	AS3682WXMi XPHAU1 UMA 1*256/ 40/6L/ 5R_bg_AN	CM420	SO256M BII5	N40GB4. 2K	NSM8X
AS3682N WXMi	AAP	Malaysia	LX.AEP0C.008	AS3682NWX Mi LINPUSMA2 UMA 1*256/ 40/6L/ 5R_bg_AN	CM420	SO256M BII5	N40GB4. 2K	NSM8X
AS3682N WXMi	AAP	Thailand	LX.AEP0C.009	AS3682NWX Mi LINPUSH2 UMA 1*256/ 40/6L/ 5R_bg_AN	CM420	SO256M BII5	N40GB4. 2K	NSM8X
AS3682W XCi	PA	USA/ Canada	LX.AEP05.032	AS3682WXCi XPHEN1 UMA 1*256/ 40/6L/ 5R_bg_AN	CM420	SO256M BII5	N40GB4. 2K	NCB24X
AS3682W XCi	PA	USA/ Canada	LX.AEP05.034	AS3682WXCi XPHFR1 UMA 1*256/ 40/6L/ 5R_bg_AN	CM420	SO256M BII5	N40GB4. 2K	NCB24X

Model	RO	Country	Acer Part no	Description	CPU	Memory	HDD 1 (GB)	ODD
AS3682W XCi	PA	ACLA- Spanish	LX.AEP05.033	AS3682WXCi XPHEs1 UMA 1*256/ 40/6L/ 5R_bg_AN	CM420	SO256M BII5	N40GB4. 2K	NCB24X
AS3682W XCi	PA	ACLA- Portugue se	LX.AEP05.037	AS3682WXCi XPHXC1 UMA 1*256/ 40/6L/ 5R_bg_AN	CM420	SO256M BII5	N40GB4. 2K	NCB24X
AS3682W XC	China	China	LX.AEP05.031	AS3682WXC XPHSC7 UMA 1*256/ 60/6L/5R/ CB_AN	CM420	SO256M BII5	N60GB5. 4K	NCB24X
AS3682W XCi	China	China	LX.AEP05.036	AS3682WXCi XPHSC7 UMA 1*512/ 60/6L/5R/ CB_bg_AN	CM420	SO512M BII5	N60GB5. 4K	NCB24X
AS3682W XCi	China	Hong Kong	LX.AEP05.035	AS3682WXCi XPHHK9 UMA 1*512/ 60/6L/5R/ CB_bg_AN	CM420	SO512M BII5	N60GB5. 4K	NCB24X
AS3681W XCi	PA	USA/ Canada	LX.AEP05.039	AS3681WXCi XPHEN1 UMA 1*256/ 40/6L/ 5R_bg_AN	CM410	SO256M BII5	N40GB4. 2K	NCB24X
AS3681W XCi	PA	USA/ Canada	LX.AEP05.041	AS3681WXCi XPHFR1 UMA 1*256/ 40/6L/ 5R_bg_AN	CM410	SO256M BII5	N40GB4. 2K	NCB24X
AS3681W XCi	PA	ACLA- Spanish	LX.AEP05.040	AS3681WXCi XPHEs1 UMA 1*256/ 40/6L/ 5R_bg_AN	CM410	SO256M BII5	N40GB4. 2K	NCB24X
AS3681W XCi	PA	ACLA- Portugue se	LX.AEP05.049	AS3681WXCi XPHXC1 UMA 1*256/ 40/6L/ 5R_bg_AN	CM410	SO256M BII5	N40GB4. 2K	NCB24X
AS3681N WXCi	AAP	Singapor e	LX.AEP0C.014	AS3681NWX Ci LINPUSSG1 UMA 1*256/ 40/6L/ 5R_bg_AN	CM410	SO256M BII5	N40GB4. 2K	NCB24X
AS3681N WXCi	AAP	India	LX.AEP0C.010	AS3681NWX Ci LINPUSIL1 UMA 1*256/ 40/6L/ 5R_bg_AN	CM410	SO256M BII5	N40GB4. 2K	NCB24X

Model	RO	Country	Acer Part no	Description	CPU	Memory	HDD 1 (GB)	ODD
AS3681N WXCi	AAP	Indonesia	LX.AEP0C.011	AS3681NWX Ci LINPUSIN1 UMA 1*256/ 40/6L/ 5R_bg_AN	CM410	SO256M BII5	N40GB4. 2K	NCB24X
AS3681N WXCi	AAP	Philippine s	LX.AEP0C.013	AS3681NWX Ci LINPUSPH1 UMA 1*256/ 40/6L/ 5R_bg_AN	CM410	SO256M BII5	N40GB4. 2K	NCB24X
AS3681N WXCi	AAP	Malaysia	LX.AEP0C.012	AS3681NWX Ci LINPUSMA2 UMA 1*256/ 40/6L/ 5R_bg_AN	CM410	SO256M BII5	N40GB4. 2K	NCB24X
AS3681N WXCi	AAP	Thailand	LX.AEP0C.015	AS3681NWX Ci LINPUSH2 UMA 1*256/ 40/6L/ 5R_bg_AN	CM410	SO256M BII5	N40GB4. 2K	NCB24X
AS3681N WXCi	AAP	Vietnam	LX.AEP0C.016	AS3681NWX Ci LINPUSVN1 UMA 1*256/ 40/6L/ 5R_bg_AN	CM410	SO256M BII5	N40GB4. 2K	NCB24X
AS3681W XCi	AAP	Australia/ New Zealand	LX.AEP05.038	AS3681WXCi XPHAU1 UMA 1*256/ 40/6L/ 5R_bg_AN	CM410	SO256M BII5	N40GB4. 2K	NCB24X
AS3681W XCi	AAP	Philippine s	LX.AEP05.045	AS3681WXCi XPHPH1 UMA 1*256/ 40/6L/ 5R_bg_AN	CM410	SO256M BII5	N40GB4. 2K	NCB24X
AS3681W XCi	AAP	Singapor e	LX.AEP05.048	AS3681WXCi XPHWSG21 W UMA 1*256/40/6L/ 5R_bg_AN	CM410	SO256M BII5	N40GB4. 2K	NCB24X
AS3681W XCi	AAP	India	LX.AEP05.042	AS3681WXCi XPHIL1 UMA 1*256/40/6L/ 5R_bg_AN	CM410	SO256M BII5	N40GB4. 2K	NCB24X
AS3681W XCi	AAP	Indonesia	LX.AEP05.043	AS3681WXCi XPHIN1 UMA 1*256/40/6L/ 5R_bg_AN	CM410	SO256M BII5	N40GB4. 2K	NCB24X
AS3681W XCi	AAP	Malaysia	LX.AEP05.044	AS3681WXCi XPHMA2 UMA 1*256/ 40/6L/ 5R_bg_AN	CM410	SO256M BII5	N40GB4. 2K	NCB24X

Model	RO	Country	Acer Part no	Description	CPU	Memory	HDD 1 (GB)	ODD
AS3681W XCi	AAP	Thailand	LX.AEP05.046	AS3681WXCi XPTH2 UMA 1*256/ 40/6L/ 5R_bg_AN	CM410	SO256M BII5	N40GB4. 2K	NCB24X
AS3681W XCi	AAP	Vietnam	LX.AEP05.047	AS3681WXCi XPHVN1 UMA 1*256/ 40/6L/ 5R_bg_AN	CM410	SO256M BII5	N40GB4. 2K	NCB24X
AS3681N WXCi	AAP	Malaysia	LX.AEP0C.018	AS3681NWX Ci LINPUSMA2 UMA 1*256/ 60/6L/ 5R_bg_AN	CM410	SO256M BII5	N60GB5. 4K	NCB24X
AS3681W XCi	AAP	Malaysia	LX.AEP05.052	AS3681WXCi XPHMA2 UMA 1*256/ 60/6L/ 5R_bg_AN	CM410	SO256M BII5	N60GB5. 4K	NCB24X
AS3681N WXCi	AAP	Malaysia	LX.AEP0C.019	AS3681NWX Ci LINPUSMA2 UMA 1*256/ 60/6L/5R/ CB_bg_AN	CM410	SO256M BII5	N60GB5. 4K	NCB24X
AS3681W XCi	AAP	Malaysia	LX.AEP05.051	AS3681WXCi XPHMA2 UMA 1*256/ 60/6L/5R/ CB_bg_AN	CM410	SO256M BII5	N60GB5. 4K	NCB24X
AS3682W XMi	AAP	Singapore	LX.AEP05.053	AS3682WXM i XPHWSG21 W UMA 1*256/80/6L/ 5R/ CB_bg_AN	CM420	SO256M BII5	N80GB5. 4K	NSM8X
AS3682W XMi	AAP	Singapore	LX.AEP05.054	AS3682WXM i XPHWSG21 W UMA 1*256/100/6L/ 5R/ CB_bg_AN	CM420	SO256M BII5	N100GB5. .4K	NSM8X
AS3682W XMi	AAP	Singapore	LX.AEP05.055	AS3682WXM i XPHWSG21 W UMA 1*512/100/6L/ 5R/ CB_bg_AN	CM420	SO512M BII5	N100GB5. .4K	NSM8X
AS3682W XMi	EMEA	Germany	LX.AEP05.056	AS3682WXM i XPHDE7 UMA 1*256/ 40/6L/ 5R_bg_AN	CM420	SO256M BII5	N40GB5. 4K	NSM8X

Model	RO	Country	Acer Part no	Description	CPU	Memory	HDD 1 (GB)	ODD
AS3682W XMi	EMEA	Germany	LX.AEP05.057	AS3682WXMi XPHDE7 UMA 1*512/ 40/6L/ 5R_bg_AN	CM420	SO512M BII5	N40GB5. 4K	NSM8X
AS3682N WXCi	EMEA	Middle East	LX.AEP0C.020	AS3682NWX Ci LINPUSAR9 UMA 1*256/ 60/6L/ 5R_bg_AN	CM420	SO256M BII5	N60GB5. 4K	NCB24X
AS3682N WXMi	EMEA	Middle East	LX.AEP0C.021	AS3682NWX Mi LINPUSAR9 UMA 1*256/ 60/BT/6L/ 5R_bg_AN	CM420	SO256M BII5	N60GB5. 4K	NSM8X
AS3681W XMi	EMEA	Germany	LX.AEP05.058	AS3681WXMi XPHDE7 UMA 1*512/ 40/6L/ 5R_bg_AN	CM410	SO512M BII5	N40GB5. 4K	NSM8X
AS3681W XMi	EMEA	Germany	LX.AEP05.059	AS3681WXMi XPHDE7 UMA 2*512/ 120/6L/ 5R_bg_AN	CM410	SO512M BII5	N120GB5 .4K	NSM8X
AS3682N WXC	China	China	LX.AEP0C.022	AS3682NWX C LINPUSSC7 UMA 1*256/ 60/6L/5R/ CB_AN	CM420	SO256M BII5	N60GB5. 4K	NCB24X
AS3681W XMi	AAP	Australia/ New Zealand	LX.AEP05.060	AS3681WXMi XPHAU1 UMA 1*256/ 60/6L/ 5R_bg_AN	CM410	SO256M BII5	N60GB5. 4K	NSM8X
AS3681W XMi	AAP	Australia/ New Zealand	LX.AEP06.001	AS3681WXMi XPPAU1 UMA 1*256/ 60/6L/ 5R_bg_AN	CM410	SO256M BII5	N60GB5. 4K	NSM8X
AS3681N WXMi	AAP	Indonesia	LX.AEP0C.023	AS3681NWX Mi LINPUSIN1 UMA 1*256/ 40/6L/ 5R_bg_AN	CM410	SO256M BII5	N40GB4. 2K	NSM8X
AS3681N WXMi	AAP	Vietnam	LX.AEP0C.024	AS3681NWX Mi LINPUSVN1 UMA 1*256/ 40/6L/ 5R_bg_AN	CM410	SO256M BII5	N40GB4. 2K	NSM8X

Model	RO	Country	Acer Part no	Description	CPU	Memory	HDD 1 (GB)	ODD
AS3682N WXCi	AAP	Philippines	LX.AEP0C.025	AS3682NWX Ci LINPUSPH1 UMA 1*256/ 60/6L/5R/ CB_bg_AN	CM420	SO256M BII5	N60GB5. 4K	NCB24X
AS3682N WXCi	EMEA	Middle East	LX.AEP0C.026	AS3682NWX Ci LINPUSAR6 UMA 1*256/ 40/6L/ 5R_bg_AN	CM420	SO256M BII5	N40GB4. 2K	NCB24X
AS3682N WXCi	EMEA	Middle East	LX.AEP0C.027	AS3682NWX Ci LINPUSAR7 UMA 1*256/ 40/6L/ 5R_bg_AN	CM420	SO256M BII5	N40GB4. 2K	NCB24X
AS3682N WXCi	EMEA	Middle East	LX.AEP0C.028	AS3682NWX Ci LINPUSARC UMA 1*256/ 40/6L/ 5R_bg_AN	CM420	SO256M BII5	N40GB4. 2K	NCB24X
AS3682W XCi	AAP	Philippines	LX.AEP05.061	AS3682WXCi XPHPH1 UMA 1*256/ 60/6L/5R/ CB_bg_AN	CM420	SO256M BII5	N60GB5. 4K	NCB24X
AS3682W XCi	AAP	Philippines	LX.AEP05.062	AS3682WXCi XPHPH1 UMA 1*512/ 60/6L/5R/ CB_bg_AN	CM420	SO512M BII5	N60GB5. 4K	NCB24X
AS3682W XCi	EMEA	South Africa	LX.AEP05.063	AS3682WXCi XPHSA1 UMA 1*512/ 40/6L/ 5R_bg_AN	CM420	SO512M BII5	N40GB4. 2K	NCB24X
AS3681W XMi	EMEA	Germany	LX.AEP05.064	AS3681WXM i XPHDE7 UMA 1*512/ 100/6L/ 5R_bg_AN	CM410	SO512M BII5	N100GB5 .4K	NSM8X
AS3681W XMi	EMEA	Belgium	LX.AEP05.065	AS3681WXM i XPHBE1 UMA 1*512/ 60/6L/5R/ CB_bg_AN	CM410	SO512M BII5	N60GB5. 4K	NSM8X
AS3681W XMi	EMEA	Holland	LX.AEP05.066	AS3681WXM i XPHNL1 UMA 1*512/ 60/6L/5R/ CB_bg_AN	CM410	SO512M BII5	N60GB5. 4K	NSM8X

Model	RO	Country	Acer Part no	Description	CPU	Memory	HDD 1 (GB)	ODD
AS3681W XMi	EMEA	Switzerland	LX.AEP05.067	AS3681WXMi XPHSW5 UMA 1*512/ 60/6L/5R/ CB_bg_AN	CM410	SO512M BII5	N60GB5. 4K	NSM8X

Aspire 5570 Series

Model	RO	Country	Acer Part no	Description	CPU	Memory	HDD 1 (GB)	ODD
AS5570A WXCi	TWN	GCTWN	S2.AEL05.001	AS5570AWX Ci XPHTC1 UMAC 2*512/ 80/BT/6L/5R/ CB_abg_1.3C _AN	CST1350	SO512M BII6	N80GB5. 4K	NCB24X
AS5571A NWXMi	AAP	India	LX.AEL0C.001	AS5571ANW XMi LinpUSIL1 UMAC 1*512/ 100/BT/6L/ 5R/ CB_abg_1.3C _AN	CDT2050	SO512M BII5	N100GB5 .4K	NSM8X
AS5571A NWXMi	AAP	Indonesia	LX.AEL0C.002	AS5571ANW XMi LinpUSIN1 UMAC 1*512/ 100/BT/6L/ 5R/ CB_abg_1.3C _AN	CDT2050	SO512M BII5	N100GB5 .4K	NSM8X
AS5571A NWXMi	AAP	Philippines	LX.AEL0C.004	AS5571ANW XMi LinpUSPH1 UMAC 1*512/ 100/BT/6L/ 5R/ CB_abg_1.3C _AN	CDT2050	SO512M BII5	N100GB5 .4K	NSM8X
AS5571A NWXMi	AAP	Malaysia	LX.AEL0C.003	AS5571ANW XMi LinpUSMA2 UMAC 1*512/ 100/BT/6L/ 5R/ CB_abg_1.3C _AN	CDT2050	SO512M BII5	N100GB5 .4K	NSM8X
AS5571A NWXMi	AAP	Thailand	LX.AEL0C.005	AS5571ANW XMi LinpUSTH2 UMAC 1*512/ 100/BT/6L/ 5R/ CB_bg_1.3C_ AN	CDT2050	SO512M BII5	N100GB5 .4K	NSM8X
AS5571A NWXMi	AAP	Vietnam	LX.AEL0C.006	AS5571ANW XMi LinpUSVN1 UMAC 1*512/ 100/BT/6L/ 5R/ CB_abg_1.3C _AN	CDT2050	SO512M BII5	N100GB5 .4K	NSM8X

Model	RO	Country	Acer Part no	Description	CPU	Memory	HDD 1 (GB)	ODD
AS5571A WXMi	AAP	Australia/ New Zealand	LX.AEL05.001	AS5571AWX Mi XPHAU1 UMAC 1*512/ 100/BT/6L/ 5R/ CB_abg_1.3C _AN	CDT2050	SO512M BII5	N100GB5 .4K	NSM8X
AS5571A WXMi	AAP	Malaysia	LX.AEL05.003	AS5571AWX Mi XPHMA2 UMAC 1*512/ 100/BT/6L/ 5R/ CB_abg_1.3C _AN	CDT2050	SO512M BII5	N100GB5 .4K	NSM8X
AS5571A WXMi	AAP	Thailand	LX.AEL05.004	AS5571AWX Mi XPTH2 UMAC 1*512/ 100/BT/6L/ 5R/ CB_bg_1.3C_ AN	CDT2050	SO512M BII5	N100GB5 .4K	NSM8X
AS5571A WXMi	AAP	Vietnam	LX.AEL05.005	AS5571AWX Mi XPHVN1 UMAC 1*512/ 100/BT/6L/ 5R/ CB_abg_1.3C _AN	CDT2050	SO512M BII5	N100GB5 .4K	NSM8X
AS5571A WXMi	AAP	Singapor e	LX.AEL05.006	AS5571AWX Mi XPHWSG21 W UMAC 1*512/100/ BT/6L/5R/ CB_abg_1.3C _AN	CDT2050	SO512M BII5	N100GB5 .4K	NSM8X
AS5571A WXMi	AAP	Indonesia	LX.AEL05.002	AS5571AWX Mi XPHIN1 UMAC 1*512/ 100/BT/6L/ 5R/ CB_abg_1.3C _AN	CDT2050	SO512M BII5	N100GB5 .4K	NSM8X
AS5571A WXMi	PA	USA/ Canada	LX.AEL05.007	AS5571AWX Mi XPHEN1 UMAC 1*512/ 100/BT/6L/ 5R/ CB_abg_1.3C _AN	CDT2050	SO512M BII5	N100GB5 .4K	NSM8X
AS5571A WXMi	PA	USA/ Canada	LX.AEL05.009	AS5571AWX Mi XPHFR1 UMAC 1*512/ 100/BT/6L/ 5R/ CB_abg_1.3C _AN	CDT2050	SO512M BII5	N100GB5 .4K	NSM8X

Model	RO	Country	Acer Part no	Description	CPU	Memory	HDD 1 (GB)	ODD
AS5571A WXMi	PA	ACLA-Spanish	LX.AEL05.008	AS5571AWX Mi XPHES1 UMAC 1*512/ 100/BT/6L/ 5R/ CB_abg_1.3C _AN	CDT2050	SO512M BII5	N100GB5 .4K	NSM8X
AS5571A WXMi	PA	ACLA-Portuguese	LX.AEL05.010	AS5571AWX Mi XPHXC1 UMAC 1*512/ 100/BT/6L/ 5R/ CB_abg_1.3C _AN	CDT2050	SO512M BII5	N100GB5 .4K	NSM8X
AS5571A WXMi	AAP	Singapore	LX.AEL05.012	AS5571AWX Mi XPHWSG21 W UMAC 1*512/120/ BT/6L/5R/ CB_abg_1.3C _AN	CDT2050	SO512M BII5	N120GB5 .4K	NSM8X
AS5571A WXMi	AAP	Singapore	LX.AEL06.001	AS5571AWX Mi XPPWSG21 W UMAC 1*512/120/ BT/6L/5R/ CB_abg_1.3C _AN	CDT2050	SO512M BII5	N120GB5 .4K	NSM8X
AS5572N WXMi	AAP	Thailand	LX.AEL0C.008	AS5572NWX Mi LINPUSH2 UMAC 1*512/ 80/BT/6L/5R/ CB_bg_1.3C _AN	CDT2300 E	SO512M BII5	N80GB5. 4K	NSM8X
AS5571A WXMi	AAP	Singapore	LX.AEL0J.001	AS5571AWX Mi MCESG1 UMAC 1*512/ 120/BT/6L/ 5R/ CB_abg_1.3C _AN	CDT2050	SO512M BII5	N120GB5 .4K	NSM8X
AS5572W XMi	AAP	Singapore	LX.AEL0J.002	AS5572WXMi MCESG1 UMAC 1*512/ 120/BT/6L/ 5R/ CB_abg_1.3C _AN	CDT2300 E	SO512M BII5	N120GB5 .4K	NSM8X
AS5572N WXMi	AAP	Vietnam	LX.AEL0C.009	AS5572NWX Mi LINPUSVN1 UMAC 1*512/ 80/BT/6L/5R/ CB_abg_1.3C _AN	CDT2300 E	SO512M BII5	N80GB5. 4K	NSM8X

Model	RO	Country	Acer Part no	Description	CPU	Memory	HDD 1 (GB)	ODD
AS5570A NWXMi	AAP	Thailand	LX.AEL0C.010	AS5570ANW XMi LINPUSH2 UMAC 1*512/ 60/6L/5R/ CB_bg_1.3C_ AN	CST1350	SO512M BII5	N60GB5. 4K	NSM8X

Aspire 5580 Series

Model	RO	Country	Acer Part no	Description	CPU	Memory	HDD 1 (GB)	ODD
AS5583W XMi	China	China	LX.AFV05.002	AS5583WXMi XPHSC7 UMAC 1*512/ 100/BT/6L/ 5R/ CB_abg_1.3C _AN	C2DT550 0	SO512M BII5	N100GB5 .4K	NSM8X
AS5583W XMi	China	Hong Kong	LX.AFV05.001	AS5583WXMi XPHHK9 UMAC 1*512/ 100/BT/6L/ 5R/ CB_abg_1.3C _AN	C2DT550 0	SO512M BII5	N100GB5 .4K	NSM8X
AS5583N WXMi	AAP	Thailand	LX.AFV0C.001	AS5583NWX Mi LINPUSH2 UMAC 1*512/ 80/BT/6L/5R/ CB_bg_1.3C_ AN	C2DT550 0	SO512M BII5	N80GB5. 4K	NSM8X

Test Compatible Components

This computer's compatibility is tested and verified by Acer's internal testing department. All of its system functions are tested under Windows® XP Home, Windows® XP Pro environment.

Refer to the following lists for components, adapter cards, and peripherals which have passed these tests. Regarding configuration, combination and test procedures, please refer to the Aspire 3680/5570/5580 series Compatibility Test Report released by the Acer Mobile System Testing Department.

Microsoft® Windows® XP Pro Environment Test

Item	Specification
CRT Port Test	
CRT Monitor	View Sonic E72f 17" PerfectFlat color CRT Area with 1280*1024
LCD Monitor	COMPAQ FP 7317 17" LCD area with 1024*768 Gateway FPD1730 17"(1280*1024)
Projector	BenQ FB8225
TV	FERGUSON DV3
Audio Jacks Port Test	
Speaker	CREATIVE HS-150 SALAR M6
Head Phone	CREATIVE ELITE-840 Hi-Fi STEREO HEADPHONE
Parallel Port Test	
Printer	Epson stylus Color 1160
USB Port Test	
USB 1.1-MouseLogitech(Optical)	Microsoft IntelliMouse Optical PS2/USB Microsoft IntelliMouse Optical PS2/USB Huaerte USB Stroll Mouse 2-button HM-28 Logitech Wheel Mouse(Optical, USB/PS2) Microsoft Track Ball Explorer(USB/PS2) USB Stroll Mouse 2-button HM-28(Scroll, wheel) Logitech(Optical) Microsoft Optical Mouse Blue USB and PS2 Compatible Logitech Cordless TrackMan Fx(Trackball, Optical) Microsoft Wireless Optical Mouse Blue(USB/PS2) Microsoft Wheel Mouse Optical(USB/PS2)
USB 1.1-keyboard	HP USB Keyboard Microsoft Wireless optical Desktop (USB/PS2) A4Tech Wireless Optical Desktop keyboard Logitech Cordless Freedom iTouch (USB/PS2) NewMen TECHNOLOGY Basic KEYBOARD ViewSonic ViewMate Internet/Multimedia Keyboard USB KeyPad: ZIPPY USB Keypad TK323
USB 1.1-Speaker	USB Mobile Theater-J1301
USB 1.1-FDD	TEAC FD-05PUB USB1.0 Device SMSC USB1.1 external Floppy Drive
USB 1.1-Camera / CCD	Logitech USB1.1 QuickCam for Notebooks pro
USB 1.1-HUB	Slim DX-274AP USB1.1 SLIM HUB 4 Port
USB 1.1-Card Reader	IWILL 6in1 USB1.1 Card Reader/Writer HP USB 1.0 digital drive POW four-in-one memory media PCMCIA
USB 2.0-HDD	NEWMAN USB2.0 HDD
USB 2.0-DVD/CD-RW	VP-6228V2 CDROMBOX
USB 2.0-HUB	D-Link DUB-H4 4-Port Hi-SPEED USB 2.0 Hub Hi-Speed 4-Port USB 2.0 HUB(IOGEAR)
USB 2.0-Printer	HP deskjet 995ck USB2.0 color printer
USB 2.0-Handy Drive	Apacer USB2.0 128MB Flash Drive Handy Steno1.1

Item	Specification
USB 2.0-Scanner	Logitech QuickCam IM(USB2.0)
1394 Port Test	
1394-HDD	Istyle Combo aluminium external box
1394-Cable	1394 4 to 4 Cable
PCMCIA Test	
Sycard Card	16bit 32bit
SCSI Card	Ultra Slim SCSI 1480B
Modem Card	billionton 56Kbps FAX Modem PC Card
16 bit Lan Card	Xircom 10/100 Network PC Card
32 bit Lan Card	NETGEAR Gigabit PC card GA511 D-Link DFE-690TXD 32bit 10/100Mb PC Card
1394 CardBus Card	Gppdvion PCMCIA convert to 1394 CardBus 2 Ports
USB2.0 CardBus Card	IOGEAR USB 2.0 2-Port CardBus Card Intopic USB2.0 Notebook cardbus Host controller
Wireless Lan Card	Linksys Wireless-G Notebook adapter 54Mbps
ATA Card	Sandisk 128MB ATA PCMCIA Flash Card
Card Reader	POW four-in-one memory media PCMCIA
PS/2 Port Test	
Mouse	A4Tech PS/2 mouse - 2 Button Microsoft FCC ID:C3KKZB1 Huaerte Wheel V60 PS/2 wheel mouse
Keyboard	ACER PS2 Keyboard Logitech PS2 Keyboard
COM/Serial Port Test	
Mouse	Logitech Serial Three Button Mouse
Memory Card Test (SD/MS/MMC/SM/CF/Microdrive/XD)	
SD Card	Sandisk 256MB SD Card Simpletech 512MB SD Card Simpletech 128MB SD Card Sandisk 1.0G SD Card X Digital Media SD 256MB
MS Card	Sony 256MB MS Card (MS Pro) LEXAR 256MB MS Card (MS Pro) Sandisk 64MB MS Card Memory Stick Duo Adaptor+Memory Stick Pro Duo 256MB
MMC Card	ScanDisk 32MB MMC Card Transcend 512MB MMC Card Transcend 1GB MMC Card
XD Card	OLYMPUS XD Picture Card 256MB
CF Card	Compact Flash Adapter

Microsoft® Windows® XP Home Environment Test

Item	Specification
CRT Port Test	
CRT Monitor	View Sonic E72f 17" PerfectFlat color CRT Area with 1280*1024
LCD Monitor	COMPAQ FP 7317 17" LCD area with 1024*768 Gateway FPD1730 17"(1280*1024)
Projector	BenQ FB8225
TV	FERGUSON DV3
Audio Jacks Port Test	
Speaker	CREATIVE HS-150 SALAR M6
Head Phone	CREATIVE ELITE-840 Hi-Fi STEREO HEADPHONE
Parallel Port Test	
Printer	Epson stylus Color 1160
USB Port Test	
USB 1.1-MouseLogitech(Optical)	Microsoft IntelliMouse Optical PS2/USB Microsoft IntelliMouse Optical PS2/USB Huaerte USB Stroll Mouse 2-button HM-28 Logitech Wheel Mouse(Optical, USB/PS2) Microsoft Track Ball Explorer(USB/PS2) USB Stroll Mouse 2-button HM-28(Scroll, wheel) Logitech(Optical) Microsoft Optical Mouse Blue USB and PS2 Compatible Logitech Cordless TrackMan Fx(Trackball, Optical) Microsoft Wireless Optical Mouse Blue(USB/PS2) Microsoft Wheel Mouse Optical(USB/PS2)
USB 1.1-keyboard	HP USB Keyboard Microsoft Wireless optical Desktop (USB/PS2) Wireless Optical Desktop keyboard Logitech Cordless Freedom iTouch (USB/PS2) NewMen TECHNOLOGY Basic KEYBOARD ViewSonic ViewMate Internet/Multimedia Keyboard USB KeyPad: ZIPPY USB Keypad TK323
USB 1.1-Speaker	USB Mobile Theater-J1301
USB 1.1-FDD	TEAC FD-05PUB USB1.0 Device SMSC USB1.1 external Floppy Drive
USB 1.1-Camera / CCD	Logitech USB1.1 QuickCam for Notebooks pro
USB 1.1-HUB	Slim DX-274AP USB1.1 SLIM HUB 4 Port
USB 1.1-Card Reader	IWILL 6in1 USB1.1 Card Reader/Writer HP USB 1.0 digital drive POW four-in-one memory media PCMCIA
USB 2.0-HDD	NEWMAN USB2.0 HDD
USB 2.0-DVD/CD-RW	VP-6228V2 CDROMBOX
USB 2.0-HUB	D-Link DUB-H4 4-Port Hi-SPEED USB 2.0 Hub Hi-Speed 4-Port USB 2.0 HUB(IOGEAR)
USB 2.0-Printer	HP deskjet 995ck USB2.0 color printer
USB 2.0-Handy Drive	Apacer USB2.0 128MB Flash Drive Handy Steno1.1

Item	Specification
USB 2.0-Scanner	Logitech QuickCam IM(USB2.0)
1394 Port Test	
1394-HDD	Istyle Combo aluminium external box
1394-Cable	1394 4 to 4 Cable
PCMCIA Test	
Sycard Card	16bit 32bit
SCSI Card	Ultra Slim SCSI 1480B
Modem Card	billionton 56Kbps FAX Modem PC Card
16 bit Lan Card	Xircom 10/100 Network PC Card
32 bit Lan Card	NETGEAR Gigabit PC card GA511 D-Link DFE-690TXD 32bit 10/100Mb PC Card
1394 CardBus Card	Gppdvion PCMCIA convert to 1394 CardBus 2 Ports
USB2.0 CardBus Card	IOGEAR USB 2.0 2-Port CardBus Card Intopic USB2.0 Notebook cardbus Host controller
Wireless Lan Card	Linksys Wireless-G Notebook adapter 54Mbps
ATA Card	Sandisk 128MB ATA PCMCIA Flash Card
Card Reader	POW four-in-one memory media PCMCIA
PS/2 Port Test	
Mouse	雙飛燕 PS/2 mouse - 2 Button Microsoft FCC ID:C3KKZB1 Huaerte Wheel V60 PS/2 wheel mouse
Keyboard	ACER PS2 Keyboard Logitech PS2 Keyboard
COM/Serial Port Test	
Mouse	Logitech Serial Three Button Mouse
Memory Card Test (SD/MS/MMC/SM/CF/Microdrive/XD)	
SD Card	Sandisk 256MB SD Card Simpletech 512MB SD Card Simpletech 128MB SD Card Sandisk 1.0G SD Card X Digital Media SD 256MB
MS Card	Sony 256MB MS Card (MS Pro) LEXAR 256MB MS Card (MS Pro) Sandisk 64MB MS Card Memory Stick Duo Adaptor+Memory Stick Pro Duo 256MB
MMC Card	ScanDisk 32MB MMC Card Transcend 512MB MMC Card Transcend 1GB MMC Card
XD Card	OLYMPUS XD Picture Card 256MB
CF Card	Compact Flash Adapter

Online Support Information

This section describes online technical support services available to help you repair your Acer Systems.

If you are a distributor, dealer, ASP or TPM, please refer your technical queries to your local Acer branch office. Acer Branch Offices and Regional Business Units may access our website. However some information sources will require a user i.d. and password. These can be obtained directly from Acer CSD Taiwan.

Acer's Website offers you convenient and valuable support resources whenever you need them.

In the Technical Information section you can download information on all of Acer's Notebook, Desktop and Server models including:

- Service guides for all models
- User's manuals
- Training materials
- Bios updates
- Software utilities
- Spare parts lists
- TABs (Technical Announcement Bulletin)

For these purposes, we have included an Acrobat File to facilitate the problem-free downloading of our technical material.

Also contained on this website are:

- Detailed information on Acer's International Traveler's Warranty (ITW)
- Returned material authorization procedures
- An overview of all the support services we offer, accompanied by a list of telephone, fax and email contacts for all your technical queries.

We are always looking for ways to optimize and improve our services, so if you have any suggestions or comments, please do not hesitate to communicate these to us.

AA

AFLASH Utility 59
Audio 41

B

Battery Pack 69
BIOS 36

- package 36
- password control 36
- ROM size 36
- ROM type 36
- vendor 36
- Version 36

 BIOS Supports protocol 36
BIOS Utility 47

- Navigating 48
- Onboard Device Configuration 54
- Security 51, 53
- System Security 58

 Board Layout

- Top View 5, 97

C

Cache

- controller 36
- size 37

 CardBus 42
CPU Fan True Value Table 36

D

Disassembly

- Battery Pack 68
- Procedure Flowchart 67

 Display 4
DVD-ROM Interface 40

E

Error Symptom-to-Spare Part Index 84
External CD-ROM Drive Check 80

F

Features 1
Flash Utility 59
Floppy Disk

- removing the 75

 FRU (Field Replaceable Unit) List 101

H

Hard disk 39
HDD 39
Hot Keys 16

I

Indicators 12
Intermittent Problems 95

J

Jumper and Connector Locations 97

- Top View 97

K

Keyboard 43
Keyboard or Auxiliary Input Device Check 80

L

L2 cache 36

M

Memory Check 81
Model Definition 114
Modem 38

N

num lock

- on indicator 13

O

Online Support Information 135

P

Panel 8

- Bottom 12
- left 8

 PC Card 12, 42
PCMCIA 42
Power System Check 81

- Battery Pack 83
- Power Adapter 82

 Processor 36

S

Second Level Cache 36

System

Block Diagram 4

System Check Procedures 80

System Memory 37

System Utilities 47

T

Test Compatible Components 129

Top 97

Touchpad Check 83

Troubleshooting 79

U

Undetermined Problems 96

USB 42

utility

BIOS 47

V

Video 41

W

Windows XP Pro Environment Test 130

Window XP Home Environment 132

