

# **Aspire 7520/7220 Series Service Guide**

Service guide files and updates are available on the ACER/CSD web; for more information, please refer to <http://csd.acer.com.tw>

PRINTED IN TAIWAN

---

# Revision History

Please refer to the table below for the updates made on Aspire 7520/7220 service guide.

Date	Chapter	Updates

---

## Copyright

Copyright © 2007 by Acer Incorporated. All rights reserved. No part of this publication may be reproduced, transmitted, transcribed, stored in a retrieval system, or translated into any language or computer language, in any form or by any means, electronic, mechanical, magnetic, optical, chemical, manual or otherwise, without the prior written permission of Acer Incorporated.

## Disclaimer

The information in this guide is subject to change without notice.

Acer Incorporated makes no representations or warranties, either expressed or implied, with respect to the contents hereof and specifically disclaims any warranties of merchantability or fitness for any particular purpose. Any Acer Incorporated software described in this manual is sold or licensed "as is". Should the programs prove defective following their purchase, the buyer (and not Acer Incorporated, its distributor, or its dealer) assumes the entire cost of all necessary servicing, repair, and any incidental or consequential damages resulting from any defect in the software.

Acer is a registered trademark of Acer Corporation.

Intel is a registered trademark of Intel Corporation.

Pentium and Pentium II/III are trademarks of Intel Corporation.

Other brand and product names are trademarks and/or registered trademarks of their respective holders.

---

## Conventions

The following conventions are used in this manual:

<b>SCREEN MESSAGES</b>	Denotes actual messages that appear on screen.
<b>NOTE</b>	Gives bits and pieces of additional information related to the current topic.
<b>WARNING</b>	Alerts you to any damage that might result from doing or not doing specific actions.
<b>CAUTION</b>	Gives precautionary measures to avoid possible hardware or software problems.
<b>IMPORTANT</b>	Reminds you to do specific actions relevant to the accomplishment of procedures.

---

## Preface

Before using this information and the product it supports, please read the following general information.

1. This Service Guide provides you with all technical information relating to the BASIC CONFIGURATION decided for Acer's "global" product offering. To better fit local market requirements and enhance product competitiveness, your regional office MAY have decided to extend the functionality of a machine (e.g. add-on card, modem, or extra memory capability). These LOCALIZED FEATURES will NOT be covered in this generic service guide. In such cases, please contact your regional offices or the responsible personnel/channel to provide you with further technical details.
2. Please note WHEN ORDERING FRU PARTS, that you should check the most up-to-date information available on your regional web or channel. If, for whatever reason, a part number change is made, it will not be noted in the printed Service Guide. For ACER-AUTHORIZED SERVICE PROVIDERS, your Acer office may have a DIFFERENT part number code to those given in the FRU list of this printed Service Guide. You MUST use the list provided by your regional Acer office to order FRU parts for repair and service of customer machines.



# System Specifications

---

## Features

Below is a brief summary of the computer's many features:

### Operating system

- q Windows® Vista™ Ultimate
- q Windows® Vista™ Home Premium
- q Windows® Vista™ Home Basic
- q Windows® Vista™ Starter

### Platform and memory

- q AMD Better By Design program, featuring:
  - AMD Turion™ 64 X2 dual-core mobile technology TL-66 / TL-64 / TL-60 / TL-56 / TL-52 (1 MB L2 cache, 2.3 GHz / 2.2 GHz / 2.0 GHz / 1.8 GHz / 1.6 GHz GHz, supporting AMD HyperTransport® technology (for selected models))
  - Mobile AMD Sempron™ 3500+/3600+/3800+ (1.8/ 2.0/2.2 GHz, 512/256/256KB L2 cache), supporting AMD HyperTransport® technology (for selected models)
  - NVIDIA nForce® 630M chipset
- q Acer InviLink™ 802.11b/g Wi-Fi CERTIFIED® solution, supporting Acer SignalUp™ wireless technology
- q Up to 2GB of DDR2 533/677 MHz memory, upgradeable to 4GB using two soDIMM modules (dual-channel support)

### Display and graphics

- q 17" WXGA + high-brightness (200-nits) Acer CrystalBrite™ TFT LCD, 1440 x 900 pixel resolution, supporting simultaneous multiwindow viewing via Acer GridVista™
- q NVIDIA GeForce® 8400M GS/GE with up to 1024MB of Turbocache™ (256MB of dedicated GDDR2 VRAM, up to 768MB of share system memory), supporting NVIDIA® PureVideo™ technology (WMV HD, High Definition MPEG-2 Hardware Acceleration), Microsoft DirectX 9 and DirectX 10, OpenEXR High Dynamic Range (HDR) technology, and PCI Express® (for selected models)
- q NVIDIA GeForce® 7000M with up to 896MB of Turbocache™ (256MB of dedicated system memory, up to 640MB of share system memory), Microsoft DirectX 9 and PCI Express (for selected models)
- q Dual independent display support
- q 16.7 million colors (for selected models)
- q MPEG-2/DVD hardware-assisted capability (acceleration) / (full decode) (for selected models)
- q WMV9 (VC-1) and H.264 (AVC) support (acceleration) / (full decode) (for selected models)
- q S-video/TV-out (NTSC/PAL) support
- q DVI-D (true digital video interface) with High-bandwidth Digital Content Protection (HDCP) support (for selected models)
- q Acer Arcade™ featuring Acer CinemaVision™ and Acer ClearVision™ technologies

### Storage subsystem

- q One or two 80/120/160/250 GB or larger hard disk drives

- 
- q Optical drive options:
    - HD-DVD drive (for selected models)
    - DVD-Super Multi double-layer drive (for selected models)
  - q 5-in-1 card reader, supporting Secure Digital (SD), MultiMediaCard (MMC), Memory Stick® (MS), Memory Stick PRO™ (MS PRO), xD-Picture Card™ (xD)

## Audio

- q Dolby®-certified surround sound system with two built-in stereo speakers (2 W) and one subwoofer supporting low-frequency effects (for selected models)
- q Dolby® Home Theater audio enhancement featuring Dolby® Digital, Dolby® Digital Live, Dolby® PRO LOGIC® II, Dolby® Digital Stereo Creator, Dolby® Headphone and Dolby® Virtual Speaker technologies
- q Intel® High Definition Audio support
- q S/PDIF (Sony/Philips Digital Interface) support for digital speakers
- q MS-Sound compatible
- q Built-in microphone

## Input devices

- q 88-/89-/93-key keyboard, with inverted "T" cursor layout; 2.5 mm (minimum) key travel
- q Seamless touchpad with 4-way scroll button
- q 12 function keys, four cursor keys, two Windows® keys, hotkey controls, standard numeric keypad, international language support, independent US and Euro dollar sign keys, media control keys
- q Empowering Key
- q Easy-launch buttons: WLAN, Internet, email, Bluetooth, Acer Arcade™
- q Volume wheel

## Communication

- q Acer Video Conference, featuring:
  - Integrated Acer Crystal Eye webcam, supporting Acer Primalite™ technology (for selected models)
  - Acer Xpress VoIP phone (for selected models)
- q WLAN: Acer InviLink™ 802.11b/g Wi-Fi CERTIFIED® network connection, supporting Acer SignalUp™ wireless technology
- q WPAN: Bluetooth® 2.0+EDR (Enhanced Data Rate) (for selected models)
- q LAN: Gigabit Ethernet; Wake-on-LAN ready
- q Modem: 56K ITU V.92 with PTT approval; Wake-on-Ring ready

## Dimensions and weight

- q 404 (W) x 298 (D) x 38/43 (H) mm (15.9x11.7x 1.5/1.7 inches)
- q 3.7 kg (8.16 lbs.)

## Power subsystem

- q ACPI 3.0 CPU power management standard: supports Standby and Hibernation power-saving modes
- q 71 W 4800 mAh Li-ion battery pack (8-cell)
- q 44Acer QuicCharge™ technology:
  - 80% charge in 1 hour
  - 2-hour rapid charge system-off



- 
- 3-hour charge-in-use.4 W 4000 mAh Li-ion battery pack (6-cell)
  - q 3-pin 90 W AC adapter

#### I/O Ports

- q ExpressCard™/54 slot
- q 5-in-1 card reader (SD/MMC/MS/MS PRO/xD)
- q Four USB 2.0 ports
- q DVI-D port with HDCP support (for selected models)
- q IEEE 1394 port
- q Consumer infrared (CIR) port
- q External display (VGA) port
- q S-video/TV-out (NTSC/PAL) port
- q Headphones/speaker/line-out port with S/PDIF support
- q AV-in port
- q Microphone-in jack
- q Line-in jack
- q Ethernet (RJ-45) port
- q Modem (RJ-11) port
- q DC-in jack for AC adapter

#### Options and accessories

- q Acer Xpress VoIP phone featuring Acer Video Conference Manager
- q Acer Media Center remote control
- q 512 MB, 1 GB or 2GB DDR2 667 MHz soDIMM modules
- q 8-cell Li-ion battery pack
- q 3-pin 90 W AC adapter
- q External USB floppy disk drive

#### Software

- q Acer Empowering Technology (Acer eNet, ePower, eAudio , ePresentation, eDataSecurity, eLock, eRecovery, eSettings Management)
- q Acer Arcade™
- q Acer Arcade Deluxe™ featuring DV Wizard, VideoMagician, DVDivine and Acer HomeMedia
- q Acer Crystal Eye
- q Acer GridVista™
- q Acer Launch Manager
- q Acer Video Conference Manager
- q Adobe® Reader®
- q CyberLink® PowerProducer®
- q Norton Internet Security™
- q NTI CD-Maker™
- q Acer GameZone
- q Microsoft Works 8.5 with Office Home and Student 2007 Trial

**NOTE:** Software listed above is for reference only. The exact configuration of your PC depends on the model purchased.

---

## Environment

- q Temperature:
  - Operating: 5°C to 35°C
  - Non-operating: -20°C to 65°C
- q Humidity (non-condensing):
  - Operating: 20%~80%
  - Non-operating: 20%~80%

## System compliance

- q Wi-Fi®
- q ACPI
- q Mobile PC 2002
- q DMI 2.0

## Warranty

- q One-year International Travelers Warranty (ITW)

**NOTE:** The specifications listed above are for reference only. The exact configuration of your PC depends on the model purchased.

# System Block Diagram

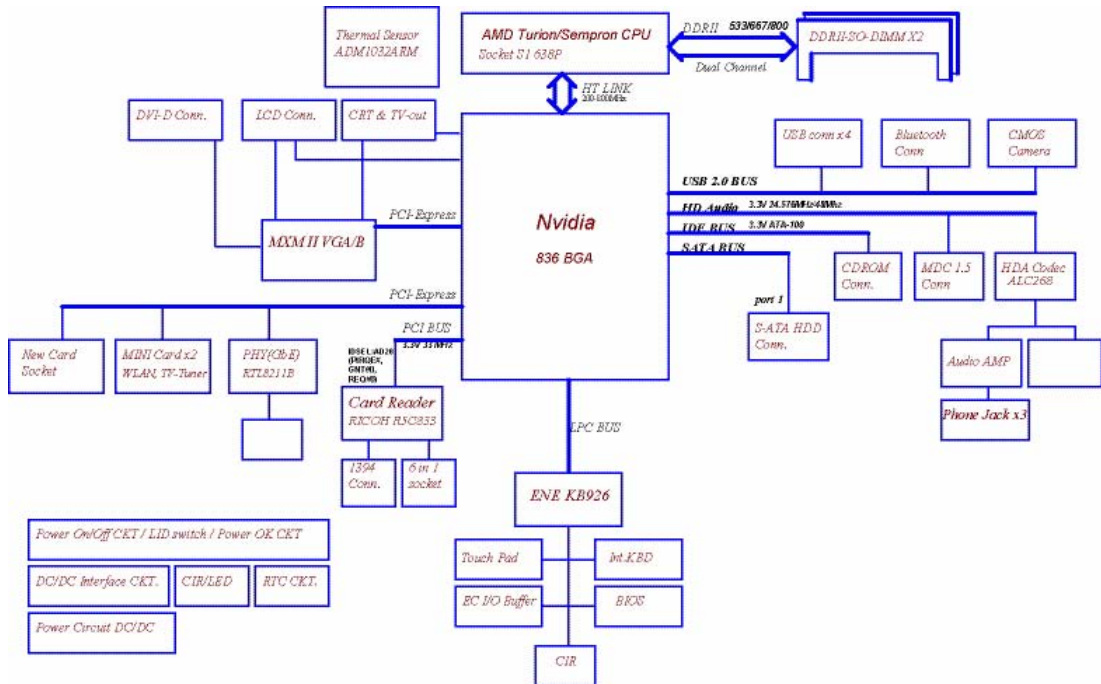

# Board Layout

## Top View

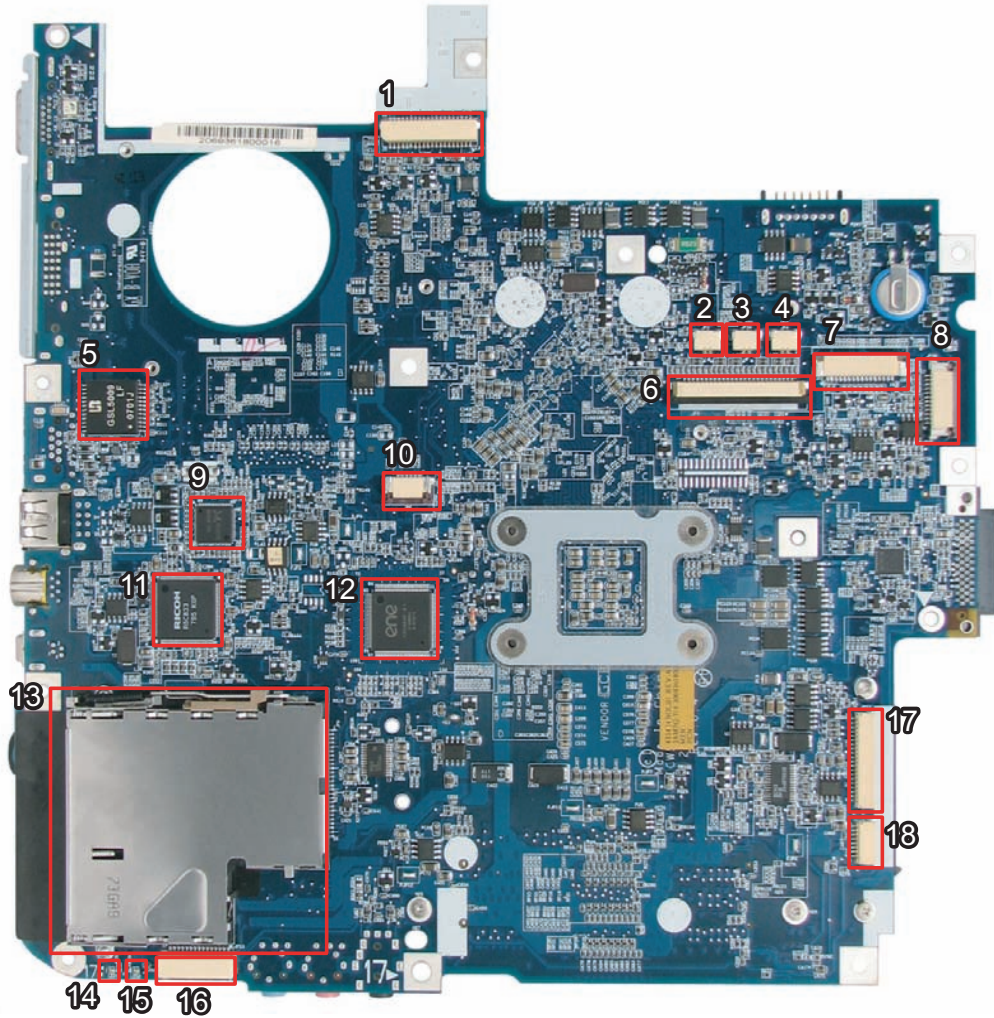

1	JP1	LVDS Connector	10	JP6	Touchpad Connector
2	JP3	Speaker (Left) Connector	11	U14	R5C833 Chip
3	JP34	Speaker (Right) Connector	12	U15	Keyboard Controller
4	JP4	Microphone Connector	13	JP9	PCI Express Card Socket
5	T1		14	LED1	Power/Suspend LED
6	JP5	Keyboard Connector	15	LED2	Battery Charge/Discharge LED
7	JP2	Button Board Connector	16	JP13	Mainboard to Audio Board Connector
8	JP36	LED Board Connector	17	JP11	Mainboard to USB & TV Board Connector
9	PHY RTL&11B Chip		18	JP12	Bluetooth Module Connector

## Bottom View

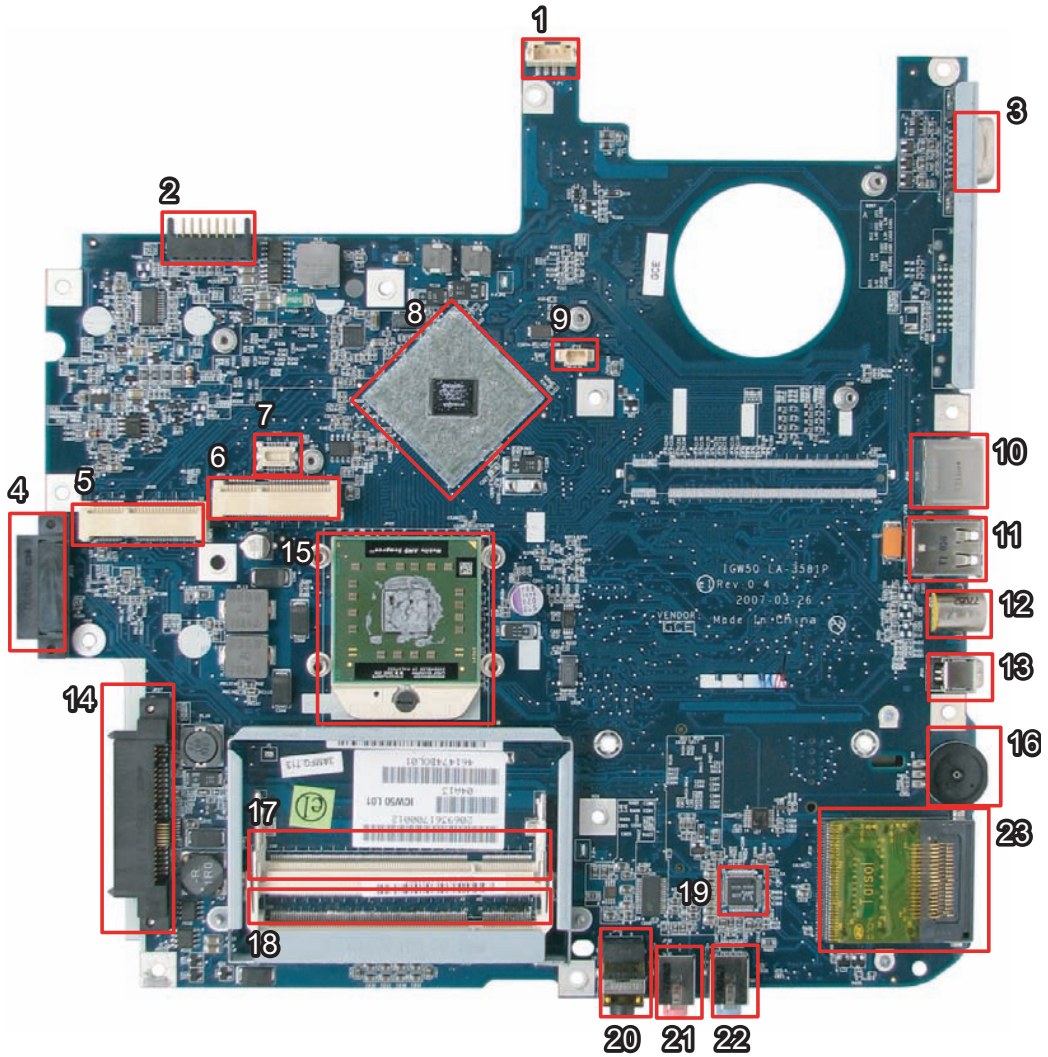





1	PJP1	DC-in Power Jack	13	JP26	IEEE1394 Connector
2	PJP2	Battery Connector	14	JP27	SATA HDD Connector
3	JP14	D-Sub CRT Connector	15	JP22	CPU Socket
4	JP25	ODD Connector	16	SW1	Volume Control
5	JP20	Mini Card (TV-Tuner) Connector	17	JP28	DDRII Memory Socket
6	JP20	Mini Card (WLAN) Connector	18	JP29	DDRII Memory Socket
7	JP21	Mini Card (TV-Tuner) Socket	19	U29	Audio Codec Controller
8	U23	North Bridge	20	JP31	Line-Out/Headphone/SPDIF Jack
9	JP16	Internal Fan Connector	21	JP32	Mic-in Jack
10	JP18	RJ45 (LAN) Connector	22	JP33	Line-in Jack
11	JP23	USB (Dual) Connectors	23	JP33	Memory Card Reader
12	JP24	TV-out Connector			

# Your Acer Notebook Tour

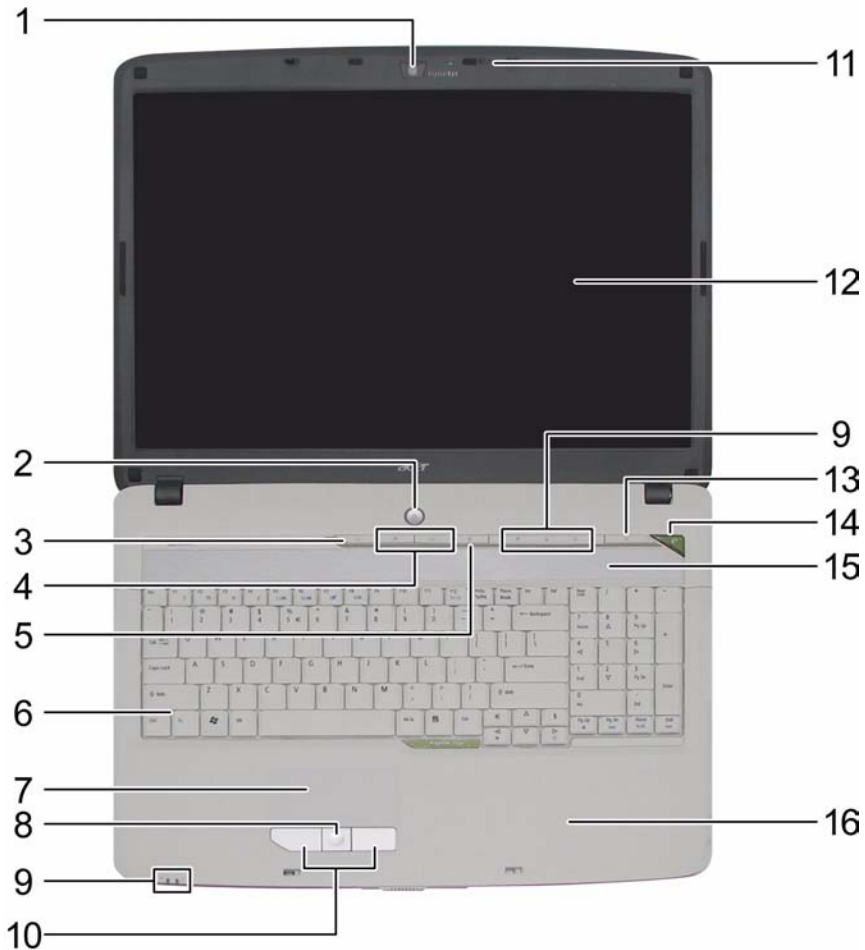
After knowing your computer features, let us show you around your new Aspire computer.

## Front View









#	Icon	Item	Description
1		Acer Crystal Eye	Web camera for video communication.
2		Power button	Turns the computer on and off.
3		Wireless communication button/indicator	Enables/disables the wireless function. Indicates the status of wireless LAN communication.
4		Easy-launch buttons	Buttons for launching frequently used programs.
5		Bluetooth <sup>®</sup> communication button/indicator	Enables/disables the Bluetooth <sup>®</sup> function. Indicates the status of Bluetooth communication.
6		Keyboard	For entering data into your computer.
7		Touchpad	Touch-sensitive pointing device which functions like a computer mouse.
8		Click buttons (center)	The center button functions like the middle mouse button.



9		Status indicators	Light-Emitting Diodes (LEDs) that light up to show the status of the computer's functions and components.
10		Click buttons (left and right)	The left and right buttons function like the left and right mouse buttons.
11		Microphone	Internal microphone for sound recording.
12		Display screen	Also called Liquid-Crystal Display (LCD), displays computer output.
13		Acer Arcade button	Launches the Acer Arcade application.
14		Empowering button	Launches the Empowering Technology toolbar.
15		Speaker	Left and right speakers deliver stereo audio output.
16		Palmrest	Comfortable support area for your hands when you use the computer.







### Closed Front View



#	Icon	Item	Description
1		Power indicator	Indicates the computer's power status.
2		Battery indicator	Indicates the computer's battery status.
3		Line-in jack	Accepts audio line-in devices (e.g., audio CD player, stereo walkman).
4		Microphone-in jack	Accepts input from external microphones.
5		Headphones/speaker/ line-out jack with S/PDIF support	Connects to audio line-out devices (e.g., speakers, headphones).
6		LCD display latch	Slide to the right to unlock the LCD display.
7		CIR receiver	Receives signals from a remote control or other infrared devices.

Left View





#	Icon	Item	Description
1		Kensington lock slot	Connects to a Kensington-compatible computer security lock.
2		External display (VGA) port	Connects to a display device (e.g., external monitor, LCD projector).
3	DVI-D	DVI-D port	Connects to a display device with DVI-D input (for selected models)
4		Ethernet (RJ-45)	Connects to an Ethernet 10/100/1000-based network (for selected models).
5		2 USB 2.0 port	Connect to USB 2.0 devices (e.g., USB mouse, USB camera).
6		S-video/TV-out (NTSC/PAL) port	Connects to a television or display device with S-video input.
7		4-pin IEEE 1394 port	Connects to IEEE 1394 devices.
8		Volume control	Increases and decreases the volume.
9		5-in-1 card reader	Accepts Secure Digital (SD), MultiMediaCard (MMC), Memory Stick (MS), Memory Stick PRO (MS PRO), xD-Picture Card (xD).
10		PCI Express Card slot	Accepts an Express Card/54 module. Note: Express Cards are third generation of PC cards, hot-swappable and smaller than previous PC Cards. Designed for both desktop and mobile use, Express Cards use either USB 2.0 or a single lane PCI Express technology that provides 500 Mbytes/sec total throughput. Formerly code named "NEWCARD," Express Cards are 5mm thick like Type II PC Cards, but do not use the same 86x54mm footprint. Express Cards come in 75x54mm and 75x34mm sizes. Express Card/54 slot means this notebook accepts 75x54mm Express Cards.



## Right View



#	Icon	Item	Description
1		2 USB 2.0 ports	Connect to USB 2.0 devices (e.g., USB mouse, USB camera).
2		AV-in port	Accepts input signals from audio/video (AV) devices (for selected models).
3		Optical drive	Internal optical drive; accepts CDs or DVDs (slot-load or tray-load depending on model).
4		Optical disk access indicator	Lights up when the optical drive is active.
5		Optical drive eject button	Ejects the optical disk from the drive.
6		Emergency eject hole	Ejects the optical drive tray when the computer is turned off.
7		Modem (RJ-11) port	Connects to a phone line.
8		RF-in jack	Accepts input signals from digital TV-tuner devices (for selected models).

## Rear view



#	Icon	Item	Description
1		DC-in jack	Connects to an AC adapter.
2		Ventilation slots	Enable the computer to stay cool, even after prolonged use.

## Base view









#	Item	Description
1	Battery bay	Houses the computer's battery pack.
2	Battery release latch	Releases the battery for removal.
3	Battery lock	Locks the battery in position.
4	Subwoofer	Emits low frequency sound output.
5	Hard disk bay	Houses the computer's hard disk (secured with screws)
6	Ventilation slots and cooling fan	Enable the computer to stay cool, even after prolonged use. Note: Do not cover or obstruct the opening of the fan.
7	Memory compartment	Houses the computer's main memory

## Indicators

The computer has several easy-to-read status indicators.



The front panel indicators are visible even when the computer cover is closed.

Icon	Function	Description
	Power	Lights up when the computer is on.
	Battery	Lights up when the battery is being charged.
	Wireless LAN	Indicates the status of wireless LAN communication.
	Bluetooth	Indicates the status of Bluetooth communication.
	HDD	Indicates when the hard disc or optical drive is active.
	Num lock	Lights when Num Lock is activated.
	Cap lock	Lights when Cap Lock is activated

**NOTE:** 1. **Charging:** The light shows amber when the battery is charging. 2. **Fully charged:** The light shows green when in AC mode.

## Easy-Launch Buttons

To the top of the keyboard there are four easy-launch buttons: Web browser, mail, arcade buttons and an Empowering Key “*e*”.

Press “*e*” to run the Acer Empowering Technology. The mail and Web browser buttons are pre-set to email and Internet programs, but can be reset by users. To set the Web browser and mail buttons, run the Launch Manager.



Launch Button	Default application
e	Acer Empowering Technology (user-programmable)
Web browser	Internet browser (user-programmable)
Mail	Email application (user-programmable)
Acer Arcade	Launches the Acer Arcade application

## Touchpad Basics

The following teaches you how to use the touchpad:

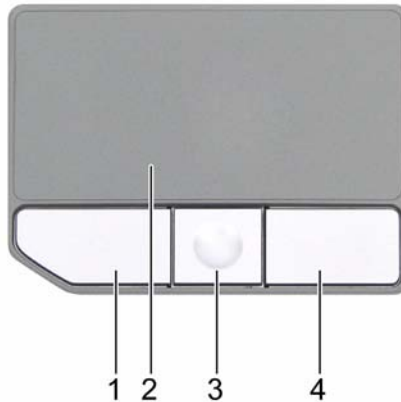

- q Move your finger across the touchpad (2) to move the cursor.
- q Press the left (1) and right (4) buttons located beneath the touchpad to perform selection and execution functions. These two buttons are similar to the left and right buttons on a mouse. Tapping on the touchpad is the same as clicking the left button.
- q The center (3) button to mimics your cursor pressing on the right scroll bar of Windows applications.

Function	Left Button (1)	Right Button (4)	Main touchpad (2)	Center button (3)
Execute	Click twice quickly		Tap twice (at the same speed as double-clicking the mouse button)	
Select	Click once		Tap once	
Drag	Click and hold, then use finger on the touchpad to drag the cursor.		Tap twice (at the same speed as double-clicking a mouse button); rest your finger on the touchpad on the second tap and drag the cursor.	
Access context menu		Click once		
Scroll				Click and hold to move up/down/left/right.

**NOTE:** When using the touchpad, keep it - and your fingers - dry and clean. The touchpad is sensitive to finger movements; hence, the lighter the touch, the better the response. Tapping too hard will not increase the touchpad's responsiveness.

# Using the Keyboard

The keyboard has full-sized keys and an embedded keypad, separate cursor keys, one Windows key and twelve function keys.

## Lock Keys and embedded numeric keypad

The keyboard has three lock keys which you can toggle on and off.

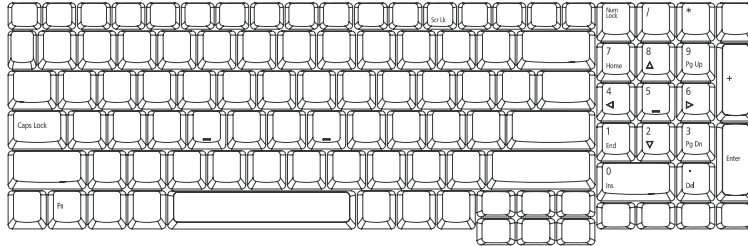









Lock Key	Description
Caps Lock	When Caps Lock is on, all alphabetic characters typed are in uppercase.
Num lock <Fn>+<F11>	When Num Lock is on, the embedded keypad is in numeric mode. The keys function as a calculator (complete with the arithmetic operators +, -, *, and /). Use this mode when you need to do a lot of numeric data entry. A better solution would be to connect an external keypad.
Scroll lock <Fn>+<F12>	When Scroll Lock is on, the screen moves one line up or down when you press the up or down arrow keys respectively. Scroll Lock does not work with some applications.

The embedded numeric keypad functions like a desktop numeric keypad. It is indicated by small characters located on the upper right corner of the keycaps. To simplify the keyboard legend, cursor-control key symbols are not printed on the keys.

Desired Access	Num Lock On	Num Lock Off
Number keys on embedded keypad	Type numbers in a normal manner.	
Cursor-control keys on embedded keypad	Hold <Shift> while using cursor-control keys.	Hold <Fn> while using cursor-control keys.
Main keyboard keys	Hold <Fn> while typing letters on embedded keypad.	Type the letters in a normal manner.

## Windows Keys

The keyboard has one key that performs Windows-specific functions.



Key	Icon	Description
Windows key 		<p>Pressed alone, this key has the same effect as clicking on the Windows Start button; it launches the Start menu. It can also be used with other keys to provide a variety of function:</p> <ul style="list-style-type: none"> <li> + &lt;Tab&gt; Activates next taskbar button.</li> <li> + &lt;E&gt; Opens the My Computer window</li> <li> + &lt;F1&gt; Opens Help and Support.</li> <li> + &lt;F&gt; Opens the Search: All Files dialog box.</li> <li> + &lt;R&gt; Opens the Run dialog box.</li> <li> + &lt;M&gt; Minimizes all windows.</li> </ul> <p>&lt;Shift&gt;+  + &lt;M&gt; Undoes the minimize all windows action.</p>
 Application key		This key has the same effect as clicking the right mouse button; it opens the application's context menu.





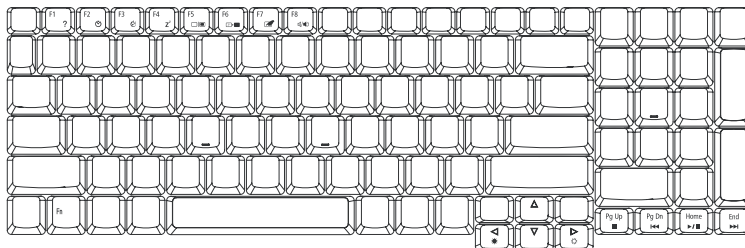





## Hot Keys

The computer employs hotkeys or key combinations to access most of the computer's controls like screen brightness, volume output, and the BIOS utility.

To activate hot keys, press and hold the <Fn> key before pressing the other key in the hotkey combination.



Hot Key	Icon	Function	Description
<Fn>+<F1>	?	Hot key help	Displays help on hot keys.
<Fn>+<F2>		Acer eSettings	Launches the Acer eSettings in Acer eManager.
<Fn>+<F3>		Acer ePower Management	Launches the Acer ePower Management in Acer Empowering Technology. <b>See “Acer Empowering Technology” on page 19.</b>
<Fn>+<F4>	Z <sup>z</sup>	Sleep	Puts the computer in Sleep mode.

Hot Key	Icon	Function	Description
<Fn>+<F5>		Display toggle	Switches display output between the display screen, external monitor (if connected) and both.
<Fn>+<F6>		Screen blank	Turns the display screen backlight off to save power. Press any key to return.
<Fn>+<F7>		Touchpad toggle	Turns the internal touchpad on and off.
<Fn>+<F8>		Speaker toggle	Turns the speakers on and off.
<Fn>+<x>		Brightness up	Increases the screen brightness.
<Fn>+<z>		Brightness down	Decreases the screen brightness
<Fn>+<Home>		Play/Pause	Plays or pauses the media.
<Fn>+<Pg Up>		Stop	Stops the media playing.
<Fn>+<Pg Dn>		Previous	Returns to previous media file.
<Fn>+<End>		Next	Jumps to next media file.

## Special Key

You can locate the Euro symbol and US dollar sign at the upper-center and/or bottom-right of your keyboard.

To type:

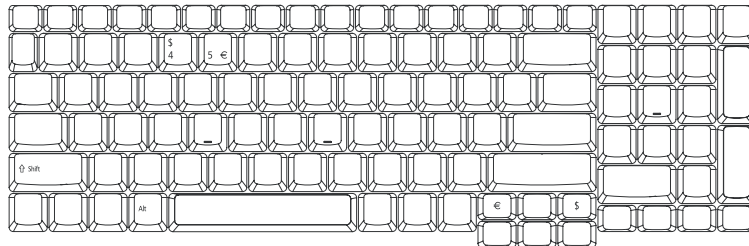

### The Euro symbol

1. Open a text editor or word processor.
2. Either directly press the <€> symbol at the bottom-right of the keyboard, or hold <Alt Gr> and then press the<5> symbol at the upper-center of the keyboard.

**NOTE:** Some fonts and software do not support the Euro symbol. Please refer to [www.microsoft.com/typography/faq/faq12.htm](http://www.microsoft.com/typography/faq/faq12.htm) for more information.

---

The US dollar sign

1. Open a text editor or word processor.
2. Either directly press the <\$> key at the bottom-right of the keyboard, or hold <Shift> and then press the <4> key at the upper-center of the keyboard.

**NOTE:** This function varies by the operating system version.



---

## Acer Empowering Technology

Acer's innovative Empowering Technology makes it easy for you to access frequently used functions and manage your new Acer notebook. It features the following handy utilities:

- q **Acer eNet Management** hooks up to location-based networks intelligently.
- q **Acer ePower Management** extends battery power via versatile usage profiles.
- q **Acer eAudio Management** allows you to easily control the enhanced sound effects of Dolby® Home Theater™ on your system.
- q **Acer ePresentation Management** connects to a projector and adjusts display settings conveniently.
- q **Acer eDataSecurity Management** protects data with passwords and advanced encryption algorithms.
- q **Acer eLock Management** limits access to external storage media.
- q **Acer eRecovery Management** backs up and recovers data flexibly, reliably and completely.
- q **Acer eSettings Management** accesses system information and adjusts settings easily.



For more information, press the < e > key to launch the Empowering Technology toolbar, then click on the appropriate utility and select the Help or Tutorial function.

### Empowering Technology password

Before using Acer eLock Management and Acer eRecovery Management, you must initialize the Empowering Technology password. Right-click on the Empowering Technology toolbar and select "Password Setup" to do so. If you do not initialize the Empowering Technology password, you will be prompted to do so when running Acer eLock Management or Acer eRecovery Management for the first time.

## Acer eNet Management

Acer eNet Management helps you to quickly and easily connect to both wired and wireless networks in a variety of locations. To access this utility, either click on the “**Acer eNet Management**” icon on your notebook, or start the program from the Start menu. You also have the option to set Acer eNet Management to start automatically when you boot up your PC.

Acer eNet Management automatically detects the best settings for a new location, while offering you the freedom to manually adjust the settings to match your needs.



Acer eNet Management can save network settings for a location to a profile, and automatically switch to the appropriate profile when you move from one location to another. Settings stored include network connection settings (IP and DNS settings, wireless AP details, etc.), as well as default printer settings.

Security and safety concerns mean that Acer eNet Management does not store username and password information.

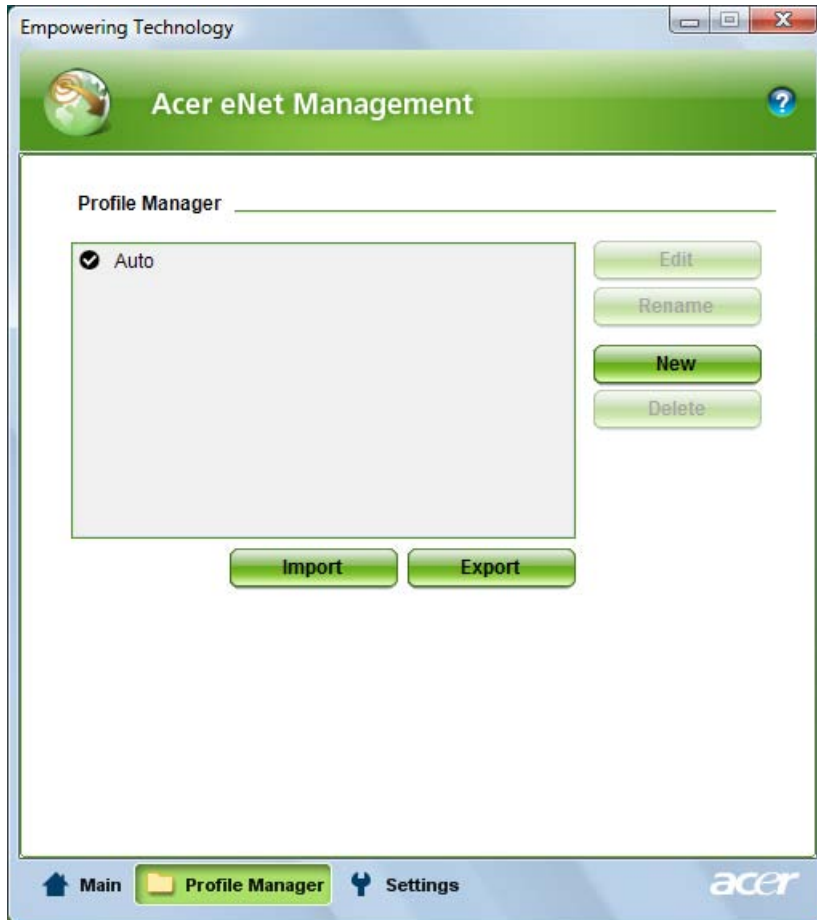

## Acer ePower Management

Acer ePower Management features a straightforward user interface. To launch it, select Acer ePower Management from the Empowering Technology interface.

### AC Mode (Adapter mode)

The default setting is "Maximum Performance." You can adjust CPU speed, LCD brightness and other settings, or click on buttons to turn the following functions on/off: Wireless LAN, Bluetooth, CardBus, FireWire (1394), Wired LAN and Optical Device if supported.

### DC Mode (Battery mode)

There are three pre-defined profiles - Balanced, Power Saver, and High Performance. You can also define the power plan optimized for your needs.

### To create new power plan

1. Select a predefined power plan and click the  icon shown on the lower left-hand side.
2. Enter the name for the newly created power plan.
3. Select one of the predefined power plan that is closest to what you want.
4. Change the display and sleep settings as desired.
5. Click "OK" to apply the setting.
6. A new power plan is created.

## Battery status

For real-time battery life estimates based on current usage, refer to the time shown in the “Remaining Battery Life” field.



For additional power options, click “**More Power Options**”.

# Acer eAudio Management

Acer eAudio Management allows you to easily control the enhanced sound effects of Dolby® Home Theater™ on your system. Select "Movie" or "Game" mode to experience the awesome realism of 5.1-channel surround sound from just 2 speakers, via Dolby Virtual Speaker technology. "Music" mode lets you enjoy your favorite tunes, in vivid detail.



(( Surround On ))



(( Surround On ))



Surround Off

---

## Acer ePresentation Management

Acer ePresentation Management lets you project your computer's display to an external device or project using the hot key: Fn + F5. If auto-detection hardware is implemented in the system, your system display will be automatically switched out when an external display is connected to the system.

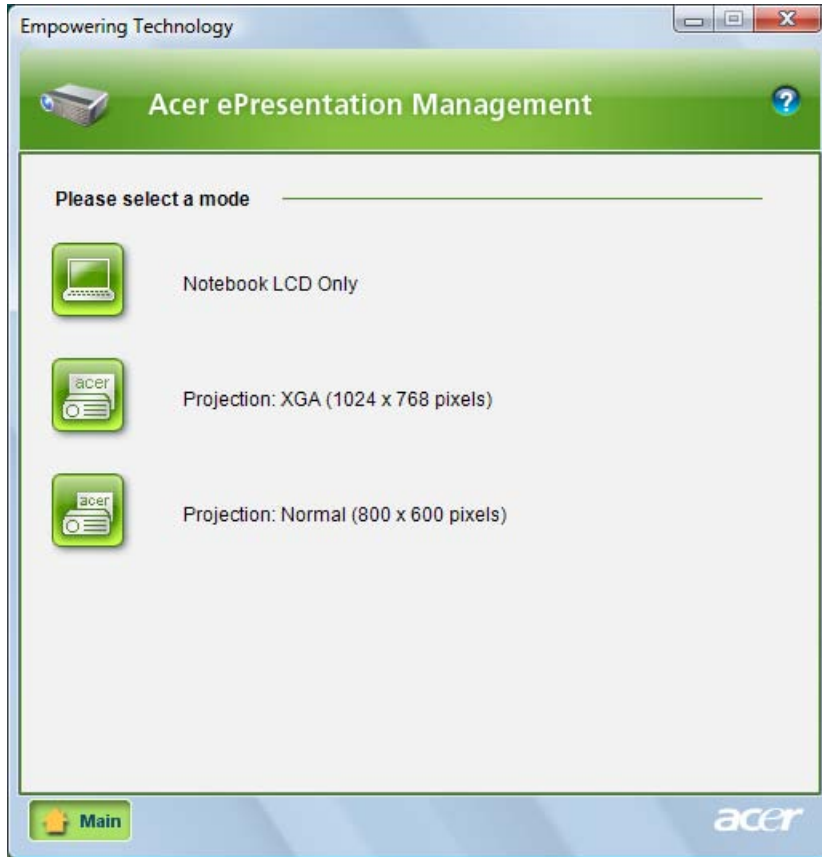

## Acer eDataSecurity Management

Acer eDataSecurity Management is handy file encryption utility that protects your files from being accessed by unauthorized persons. It is conveniently integrated with Windows explorer as a shell extension for quick and easy data encryption/decryption and also supports on-the-fly file encryption for MSN Messenger and Microsoft Outlook.

The Acer eDataSecurity Management setup wizard will prompt you for a supervisor password and default encryption. This encryption will be used to encrypt files by default, or you can choose to enter your won file-specific password when encrypting a file.

**NOTE:** The password used encrypt a file is the unique key that the system needs to decrypt it. If you lose the password, the supervisor password is the only other key capable of decrypting the file. If you lose both passwords, there will be no way to decrypt your encrypted file! **Be sure to safeguard all related passwords!**

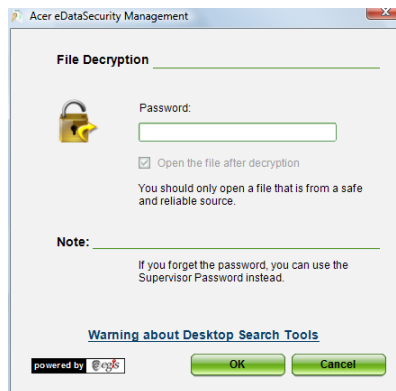
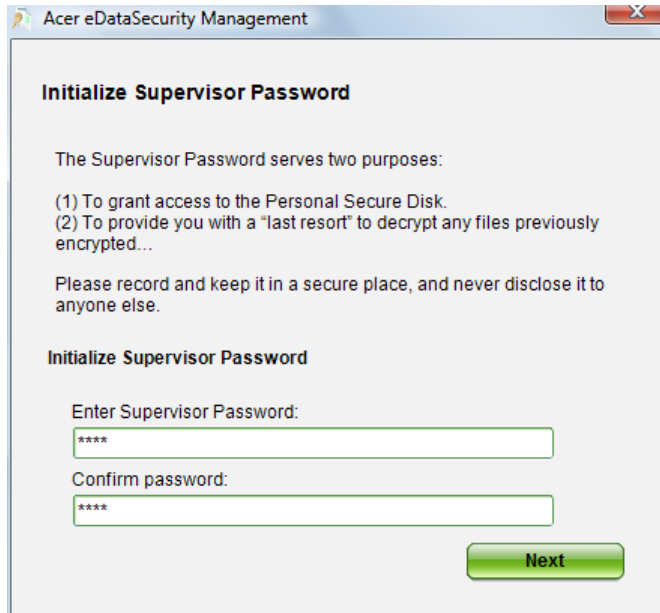

## Acer eLock Management

Acer eLock Management is a security utility that allows you to lock your removable data, optical and floppy drives to ensure that data cannot be stolen while your notebook is unattended.

- q Removable data devices - includes USB disk drives, USB pen drives, USB flash drives, USB MP3 drives, USB memory card readers, IEEE 1394 disk drives and any other removable disk drives that can be mounted as a file system when plugged into the system.
- q Optical drive devices - includes any kind of CD-ROM or DVD-ROM drives.
- q Floppy disk drives - 3.5-inch disks only.
- q Interfaces - includes serial ports, parallel port, infrared (IR), and Bluetooth.

To activate Acer eLock Management, a password must be set first. Once set, you can apply locks to any of the devices. Lock(s) will immediately be set without any reboot necessary, and will remain locked after rebooting, until unlocked.

**NOTE:** If you lose your password, there is no method to reset it except by reformatting your notebook or taking your notebook to an Acer Customer Service Center. Be sure to remember or write down your password.

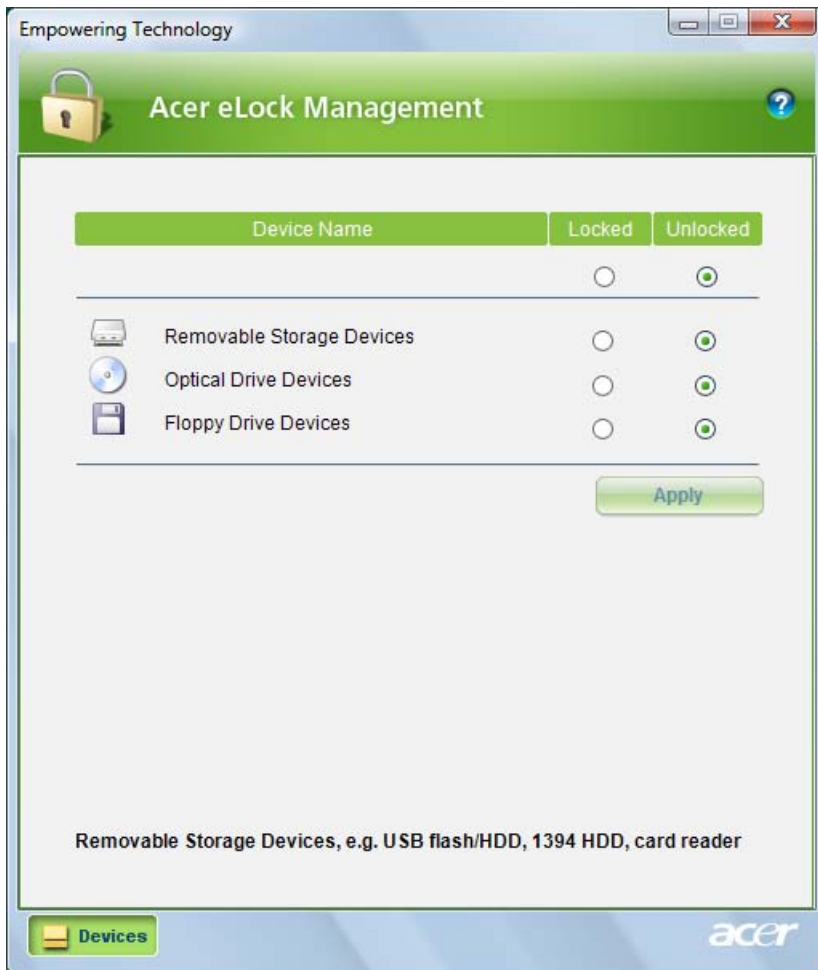



## Acer eRecovery Management

Acer eRecovery Management is a powerful utility that does away with the need for recovery disks provided by the manufacturer. The Acer eRecovery Management utility occupies space in a hidden partition on your system's HDD. User-created backups are stored on D:\ drive. Acer eRecovery Management provides you with:

- q Password protection.
- q Recovery of applications and drivers.
- q Image/data backup:
  - q Back up to HDD (set recovery point).
  - q Back up to CD/DVD.
- q Image/data recovery tools:
  - q Recover from a hidden partition (factory defaults).
  - q Recover from the HDD (most recent user-defined recovery point).
  - q Recover from CD/DVD.

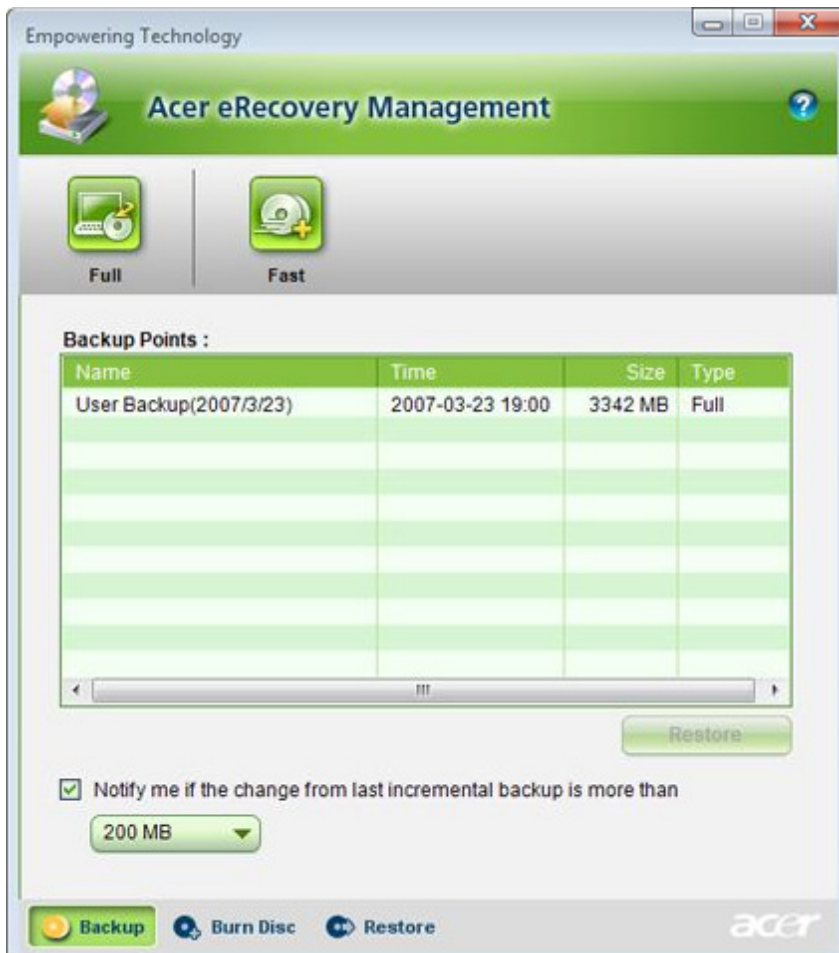

For more information, please refer to “Acer eRecovery Management”

**NOTE:** If your computer did not come with a Recovery CD or System CD, please use Acer eRecovery Management’s “System backup to optical disk” feature to burn a backup image to CD or DVD. To ensure the best results when recovering your system using a CD or Acer eRecovery Management, detach all peripherals (except the external Acer ODD, if your computer has one), including your Acer ezDock.

## Acer eSettings Management

Acer eSettings Management allows you to inspect hardware specifications and to monitor the system health status. Furthermore, Acer eSettings Management enables you to optimize your Windows operating system, so your computer runs faster, smoother and better.

Acer eSettings Management also:

- q Provides a simple graphical user interface for navigating.
- q Displays general system status and advanced monitoring for power users.



---

## Getting to know your Acer Crystal Eye webcam

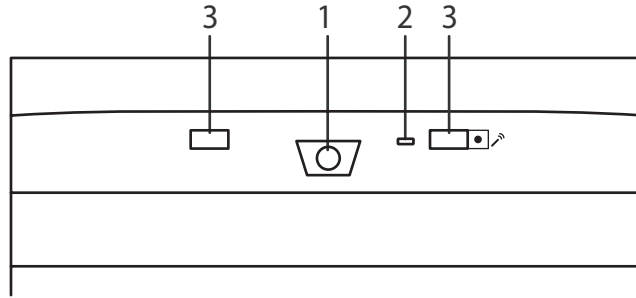

No.	Item
1	Lens
2	Power indicator
3	Rubber grip (selected models only)

## Launching the Acer Crystal Eye webcam

To launch the Acer Crystal Eye webcam, double click on the Acer OrbiCam icon on the screen.

OR

Click Start > All programs > Acer > Crystal Eye webcam. The Acer Crystal Eye webcam capture window appears.

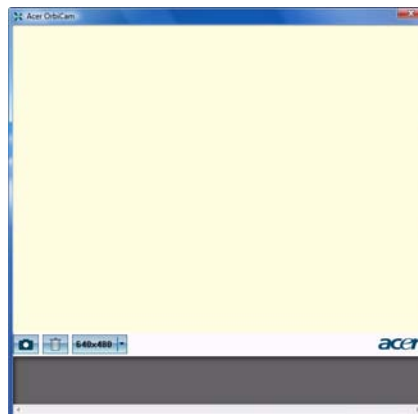

## Changing the Acer Crystal Eye resolution

To change the capture resolution, click the displayed resolution button to select the desired resolution.

## Using the Acer Crystal Eye as webcam

The Acer Crystal Eye is automatically selected as the capture device of any instant messenger (IM) application. To use the Acer Crystal Eye as a webcam, open the IM service, then select the video/webcam feature. You can now broadcast from your location to an IM partner anywhere in the world.

## Using the System Utilities

**NOTE:** The system utilities work under Microsoft Windows XP only.

### Acer GridVista (dual-display compatible)

**NOTE:** This feature is only available on certain models.

To enable the dual monitor feature of the notebook, first ensure that the second monitor is connected, then select **Start, Control Panel, Display** and click on **Settings**. Select the secondary monitor (**2**) icon in the display box and then click the check box **Extend my windows desktop onto this monitor**. Finally, click **Apply** to confirm the new settings and click **OK** to complete the process.

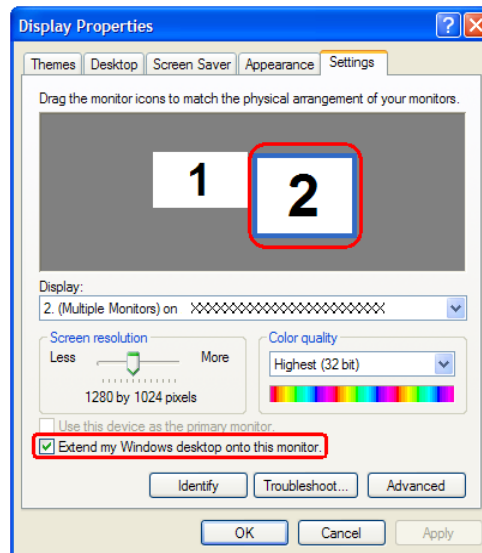

Acer GridVista is a handy utility that offers four pre-defined display settings so you can view multiple windows on the same screen. To access this function, please go to **Start > All Programs** and click on **Acer GridVista**. You may choose any one of the four display settings indicated below:



Double (vertical), Triple (primary at left), Triple (primary at right), or Quad Acer Gridvista is dual-display compatible, allowing two displays to be partitioned independently.

Acer Gridvista is dual-display compatible, allowing two displays to be partitioned independently.

AcerGridVista is simple to set up:

1. Run Acer GridVista and select your preferred screen configuration for each display from the task bar.
2. Drag and drop each window into the appropriate grid.
3. Enjoy the convenience of a well-organized desktop.

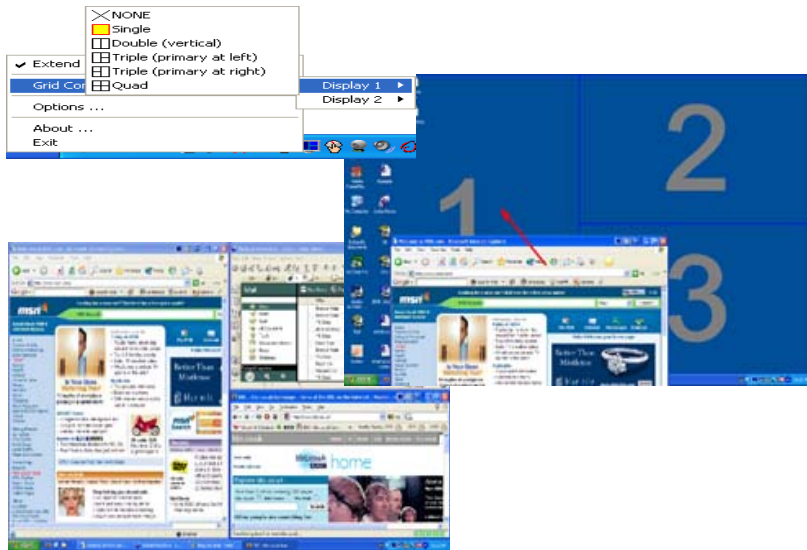

**NOTE:** Please ensure that the resolution setting of the second monitor is set to the manufacturer's recommended value.

## Launch Manager



Launch Manager allows you to set the four easy-launch buttons (see their locations mentioned in “Easy-Launch Buttons”). You can access the Launch Manager by clicking Start > All Programs > Launch Manager to start the application.

# Hardware Specifications and Configurations

## Processor

Item	Specification
CPU type	AMD Turion™ 64 X2 dual-core mobile technology TL-66 / TL-64 / TL-60 / TL-56 / TL-52 (1 MB L2 cache, 2.3 GHz / 2.2 GHz / 2.0 GHz / 1.8 GHz / 1.6 GHz GHz, supporting AMD HyperTransport® technology (for selected models) Mobile AMD Sempron™ 3500+/3600+/3800+ (1.8/ 2.0/2.2 GHz, 512/256/ 256KB L2 cache), supporting AMD HyperTransport® technology (for selected models)
Core logic	North Bridge NVIDIA nForce® 630M chipset
CPU package	S1 Socket package CPU with 638-pin Lindless Micro PGA package
CPU core voltage	0.944~1.3V

## CPU Fan True Value Table

TEST Condition: 35W@Ambient 35 degree C			
CPU Temperature		Fan Speed	Acoustic Level
Core 0	Core 1	(rpm)	(dBA)
86	86	3700	39
88	88	3450	36.5
91	91	3150	34.5
95	95	2800	31

## BIOS

Item	Specification
BIOS vendor	Phoenix TrustedCore / PhoenixBIOS
BIOS Version	Phoenix TrustedCore ver 1.14 / PhoenixBIOS ver 1.01
BIOS ROM type	Flash ROM
BIOS ROM size	512KB
BIOS package	32-pin PLCC
Supported protocols	ACPI 1.0b/2.0/3.0, PCI 2.2, System/HDD Password Security Control, INT 13h Extensions, PnP BIOS 1.0a, SMBIOS 2.4, Simple Boot Flag 1.0, Boot Block, PCI Bus Power Management Interface Specification, USB1.1/2.0, IEEE 1394 1.0, USB/1394 CD-ROM Boot Up support, PC Card 95 (PCMCIA 3.0 Compliant Device), IrDA 1.0, Intel AC97 CNR Specification, WfM 2.0, PXE (Preboot Execution Environment), BIS 1.0 (Boot Integrity Service Application Program Interface), PC99a and Mobile PC2001 Compliant, Intel Enhanced SpeedStep Technology
BIOS password control	Set by setup manual

**NOTE:** If you need to check PXE version, press F2 to enter BIOS then enable boot from LAN function. After that, power off the system and remove the HDD. Last, reboot the laptop. Then you will see the PXE version displayed on screen.

## Second Level Cache

Item	Specification
Cache controller	Built-in CPU
Cache size	2MB
1st level cache control	Always enabled
2st level cache control	Always enabled

## Second Level Cache

Item	Specification
Cache scheme control	Fixed in write-back

## System Memory

Item	Specification
Memory controller	North Bridge NVIDIA® MCP67-MV (Single chip)
Memory size	0MB (no on-board memory)
DIMM socket number	2 sockets
Supports memory size per socket	2GB
Supports maximum memory size	4GB (by two 1024MB SO-DIMM module)
Supports DIMM type	DDR 2 Synchronous DRAM
Supports DIMM Speed	667 MHz
Supports DIMM voltage	1.8V and 0.9V
Supports DIMM package	200-pin soDIMM
Memory module combinations	You can install memory modules in any combinations as long as they match the above specifications.

## Memory Combinations

Slot 1	Slot 2	Total Memory
0MB	128MB	128MB
0MB	256MB	256MB
0MB	512MB	512MB
0MB	1024MB	1024MB
0MB	2048MB	2048MB
128MB	128MB	256MB
128MB	256MB	384MB
128MB	512MB	640MB
128MB	1024MB	1152MB
128MB	2048MB	2176MB
256MB	128MB	384MB
256MB	256MB	512MB
256MB	512MB	768MB
256MB	1024MB	1280MB
256MB	2048MB	2304MB
512MB	128MB	640MB
512MB	256MB	768MB
512MB	512MB	1024MB
512MB	1024MB	1536MB
512MB	2048MB	2560MB
1024MB	0MB	1024MB
1024MB	128MB	1152MB
1024MB	256MB	1280MB
1024MB	512MB	1536MB
1024MB	1024MB	2048MB
1024MB	2048MB	3072MB

Above table lists some system memory configurations. You may combine DIMMs with various capacities to form other combinations. On above table, the configuration of slot 1 and slot 2 could be reversed.

### System VRAM and VBIOS Options

System Memory	VBIOS Option in BIOS/CMOS	eSetting		OS		
		VRAM size		System memory size	VRAM size	System memory size
512Mb	128MB	Dedicated	128MB	512MB	192MB	512MB
		Max. available	192MB			
	256MB	Dedicated	256MB	512MB	320MB	512MB
		Max. available	320MB			
	512MB	Dedicated	512MB	512MB	578MB	512MB
		Max. available	576MB			
1024MB	128MB	Dedicated	128MB	1024MB	383MB	1024MB
		Max. available	383MB			
	256MB	Dedicated	256MB	1024MB	511MB	1024MB
		Max. available	511MB			
	512MB	Dedicated	512MB	1024MB	767MB	1024MB
		Max. available	767MB			
2048MB	128MB	Dedicated	128MB	2048MB	895MB	2048MB
		Max. available	895MB			
	256MB	Dedicated	256MB	2048MB	1023MB	2048MB
		Max. available	1023MB			
	512MB	Dedicated	512MB	2048MB	1279MB	2048MB
		Max. available	1279MB			
4096MB	128MB	Dedicated	128MB	4096MB	1919MB	4096MB
		Max. available	1919MB			
	256MB	Dedicated	256MB	4096MB	2047MB	4096MB
		Max. available	2047MB			
	512MB	Dedicated	512MB	4096MB	2303MB	4096MB
		Max. available	2303MB			

### LAN Interface

Item	Specification
Chipset	Broadcom 5787
Supports LAN protocol	10/100/1000 Ethernet Giga LAN
LAN connector type	RJ45
LAN connector location	Left side
Features	Integrated 10/100/1000 BASE-T transceiver Wake on LAN support compliant with ACPI 2.0 PCI v2.2

### Modem Interface

Item	Specification
Data modem data baud rate (bps)	56K
Supports modem protocol	V.92



## Modem Interface

Item	Specification
Modem connector type	RJ11
Modem connector location	Right side

## Bluetooth Interface

Item	Specification
Chipset	Broadcom Bluetooth® 2.0+EDR
Data throughput	723 bps (full speed data rate)
Protocol	Bluetooth 1.1 (Upgradeable to Bluetooth 1.2 when SIG specification is ratified).
Interface	USB 1.1
Connector type	USB

## Wireless Module 802.11a/b/g/n

Item	Specification
Chipset	Broadcom 4311/4312 or Atheros XB63
Data throughput	11~54 Mbps
Protocol	802.11a+b+g+Draft-n/802.11a+b+g/802.11b+g
Interface	PCI

## Hard Disk Drive Interface

Item				
Vendor & Model Name	HGST HTS541680J9SA00 Seagate ST980811AS Toshiba MK8037GSX WD WD800BEVS-22RST0	HGST HTS541612J9SA00 Seagate ST9120822AS Toshiba MK1237GSX WD WD1200BEVS-22RST0	HGST HTS541616J9SA00 Seagate ST9160821AS Toshiba MK1637GSX WD WD1600BEVS-22RST0	Toshiba MK2035GSS
Capacity (MB)	80000	120000	160000	200000
Bytes per sector	512	512	512	512
Data heads	2	3 (for Hitachi and Seagate) 4 (for Toshiba)	4 (for Hitachi) 3 (for Seagate)	
Drive Format				
Disks	1	1	1	1
Spindle speed (RPM)	5400 RPM	5400 RPM	5400 RPM	4200 RPM
Performance Specifications				
Buffer size	2048KB	8192KB	8192KB	8192KB
Interface	ATA/ATAPI-6; ATA-6	ATA/ATAPI-6; ATA-6	ATA/ATA-6; ATA-6	ATA/ATA-6; ATA-6
Max. media transfer rate (disk-buffer, Mbytes/s)	372	350	350	350
Data transfer rate (host-buffer, Mbytes/s)	100 MB/Sec. Ultra DMA mode-5	100 MB/Sec. Ultra DMA mode-5	100 MB/Sec. Ultra DMA mode-5	100 MB/Sec. Ultra DMA mode-5
DC Power Requirements				

## Hard Disk Drive Interface

Item				
Voltage tolerance	5V(DC) +/- 5%	5V(DC) +/- 5%	5V(DC) +/- 5%	5V(DC) +/- 5%

## DVD-Dual Interface

Item	Specification	
Vendor & model name	HLDS COMBO 12.7mm Tray 24X GCC-T10N SONY COMBO 12.7mm Tray 24X CRX880A LF PIONEER Super-Multi Drive 12.7mm Tray DVR-K17RS PANASONIC Super-Multi Drive 12.7mm Tray DL 8X UJ-850 PHILIPS Super-Multi Drive 12.7mm Tray DL 8X DS-8A1P HLDS Super-Multi Drive 12.7mm Tray LabelFlash 8X GSA-T20N SONY Super-Multi Drive 12.7mm Tray DL 8X AD-7530A TOSHIBA HD-DVD Drive 12.7mm Tray TS-L802A	
Performance Specification	With CD Diskette	With DVD Diskette
Transfer rate (KB/sec)	Sustained: Max 3.6Mbytes/sec	Sustained: Max 10.8Mbytes/sec
Buffer Memory	2MB	
Interface	Enhanced IDE(ATAPI) compatible	
Applicable disc format	Support disc formats 1. Reads data in each CD-ROM, CD-ROM XA, CD-1, Video CD, CD-Extra and CD-Text 2. Reads data in Photo CD (single and Multi-session) 3. Reads standard CD-DA 4. Reads and writes CD-R discs 5. Reads and writes CD-RW discs 6. Reads and writes in each DVD+R/RW (Ver. 1.1) 7. Reads data in each DVD-ROM and DVD-R (Ver. 2.0 for Authoring) 8. Reads and writes in each DVD-R (Ver. 2.0 for general), DVD-RW and DVD+R/RW (Ver1.1)	
Loading mechanism	Load: Manual Release: (a) Electrical Release (Release Button) (b) Release by ATAPI command (c) Emergency Release	
Power Requirement		
Input Voltage	5 V +/- 5 % (Operating)	

## Audio Interface

Item	Specification
Audio Controller	Realtek ALC268
Audio onboard or optional	Built-in
Mono or Stereo	Stereo
Resolution	18 bit stereo full duplex
Compatibility	HD audio Interface; S/PDIF output for PCM or AC-3 content
Sampling rate	1Hz resolution VSR (Variable Sampling Rate)
Internal microphone	Yes
Internal speaker / Quantity	Yes/2 (2W speakers)
Supports PnP DMA channel	DMA channel 0 DMA channel 1
Supports PnP IRQ	IRQ10, IRQ11

---

**Audio Interface**

Item	Specification
Subwoofer	Yes (2W) (Optional)

## USB Port

Item	Specification
Chipset	Built-in ICH8M
USB Compliancy Level	2.0
OHCI	USB 1.1 and USB 2.0 Host controller
Number of USB port	4
Location	One on the left side; three on the rear side
Serial port function control	Enable/Disable by BIOS Setup

## PCMCIA Port

Item	Specification
PCMCIA controller	TI PCI 7412
Supports card type	Type-II
Number of slots	One type-II
Access location	Left side
Supports ZV (Zoomed Video) port	No ZV support
Supports 32 bit CardBus	Yes

## System Board Major Chips

Item	Controller
Core logic	North Bridge NVIDIA® MCP67-MV (Single chip)
LAN	Realtek RTL8211B
USB 2.0	Built in ICH8M
Super I/O controller	NS 87383
MODEM	Connexant MDC 1.5 Card
Bluetooth	Broadcom 2045 Bluetooth® 2.0+EDR
Wireless LAN	Broadcom 4311/4312 or Atheros XB63 Fox BRM 4311 Minicard BG
PCMCIA	TI PCI 7412
Audio	Realtek ALC268

## Keyboard

Item	Specification
Keyboard controller	KB926
Total number of keypads	88-/89-key
Windows logo key	Yes
Internal & external keyboard work simultaneously	Plug USB keyboard to the USB port directly: Yes

## Battery

Item	Specification
Vendor & model name	BATTERY PANASONIC LI-ION 6CELLS BATTERY SANYO LI-ION 6CELLS BATTERY SIMPLO LI-ION 6CELLS BATTERY SONY LI-ION 6CELLS BATTERY PANASONIC LI-ION 8CELLS BATTERY SANYO LI-ION 8CELLS BATTERY SIMPLO LI-ION 8CELLS BATTERY SONY LI-ION 8CELLS
Battery Type	Li-ion
Pack capacity	2000 mAH or 2400 mAH
Number of battery cell	6 cell or 8cell
Package configuration	9 cells in series, 2 series in parallel
Normal voltage	14.8V
Charge voltage	16.8+-0.2v

## LCD 15.4" inch

Item	Specification			
Vendor & model name	LPL LP154WX4- TLB2 (G)	CMO N154I2- L05 GLARE	AUO B154EW02 V7(G)	SAMSUNG LTN154AT01- 001(G)
Screen Diagonal (mm)	17 inches	17 inches	17 inches	17 inches
Active Area (mm)	304.1x228.1	304.1x228.1	304.1x228.1	
Display resolution (pixels)	1440x900 WXGA+	1440x900 WXGA+	1440x900 WXGA+	1440x900 WXGA+
Pixel Pitch	0.297x0.297	0.099x0.297	0.297x0.297	
Pixel Arrangement	R.G.B. Vertical Stripe	R.G.B. Vertical Stripe	R.G.B. Vertical Stripe	R.G.B. Vertical Stripe
Display Mode	Normally White	Normally White	Normally White	Normally White
Typical White Luminance (cd/m <sup>2</sup> ) also called Brightness	300	300	300	300
Luminance Uniformity	N/A	N/A	70	70
Contrast Ratio	300	300	250	250
Response Time (Optical Rise Time/Fall Time)msec	8	8	8	8
Nominal Input Voltage VDD	+3.3V Typ.	+3.3V	3.3V	3.3V
Typical Power Consumption (watt)	5.6/5.7	3.96	N/A	N/A
Weight	550	570	600	600
Physical Size(mm)	317.3x242.0x6. 0	317.3x242.0x5. 9	317.3x242.0x6. 5	317.3x242.0x6. 5
Electrical Interface	1 channel LVDS	1 channel LVDS	1 channel LVDS	1 channel LVDS
Support Color	262K colors (RGB 6-bit data driver)	262,144	262,144	262,144
Viewing Angle (degree)				
Horizontal: Right/Left	40/40	45/45	40/40	40/40
Vertical: Upper/Lower	10/30	15/35	20/40	20/40

## LCD 15.4" inch

Item	Specification			
Temperature Range(° C)				
Operating	0 to +50	0 to +50	0 to +50	0 to +50
Storage (shipping)	-20 to +60	-25 to +60	-20 to +60	-20 to +60

## LCD Inverter

Item	Specification
Vendor & model name	Darfon/V189-301GP
Brightness conditions	N/A
Input voltage (V)	9~21
Input current (mA)	2.56 (max)
Output voltage (V, rms)	780V (2000V for kick off)
Output current (mA, rms)	6.5 (max)
Output voltage frequency (k Hz)	65K Hz (max)

## AC Adapter

Item	Specification
Input rating	90V AC to 264V AC, 47Hz to 63Hz
Maximum input AC current	1.7A
Inrush current	220A@115VAC 220A@230VAC
Efficiency	82% min. @115VAC input full load

## System Power Management

ACPI mode	Power Management
Mech. Off (G3)	All devices in the system are turned off completely.
Soft Off (G2/S5)	OS initiated shutdown. All devices in the system are turned off completely.
Working (G0/S0)	Individual devices such as the CPU and hard disc may be power managed in this state.
Suspend to RAM (S3)	CPU set power down VGA Suspend PCMCIA Suspend Audio Power Down Hard Disk Power Down CD-ROM Power Down Super I/O Low Power mode
Save to Disk (S4)	Also called Hibernation Mode. System saves all system states and data onto the disc prior to power off the whole system.

## System Utilities

### BIOS Setup Utility

The BIOS Setup Utility is a hardware configuration program built into your computer's BIOS (Basic Input/Output System).

Your computer is already properly configured and optimized, and you do not need to run this utility. However, if you encounter configuration problems, you may need to run Setup. Please also refer to Chapter 4 Troubleshooting when problem arises.

To activate the BIOS Utility, press **m** during POST (when "Press <F2> to enter Setup" message is prompted on the bottom of screen).

Press **m** to enter setup. The default parameter of F12 Boot Menu is set to "disabled". If you want to change boot device without entering BIOS Setup Utility, please set the parameter to "enabled".

Press <F12> during POST to enter multi-boot menu. In this menu, user can change boot device without entering BIOS SETUP Utility.

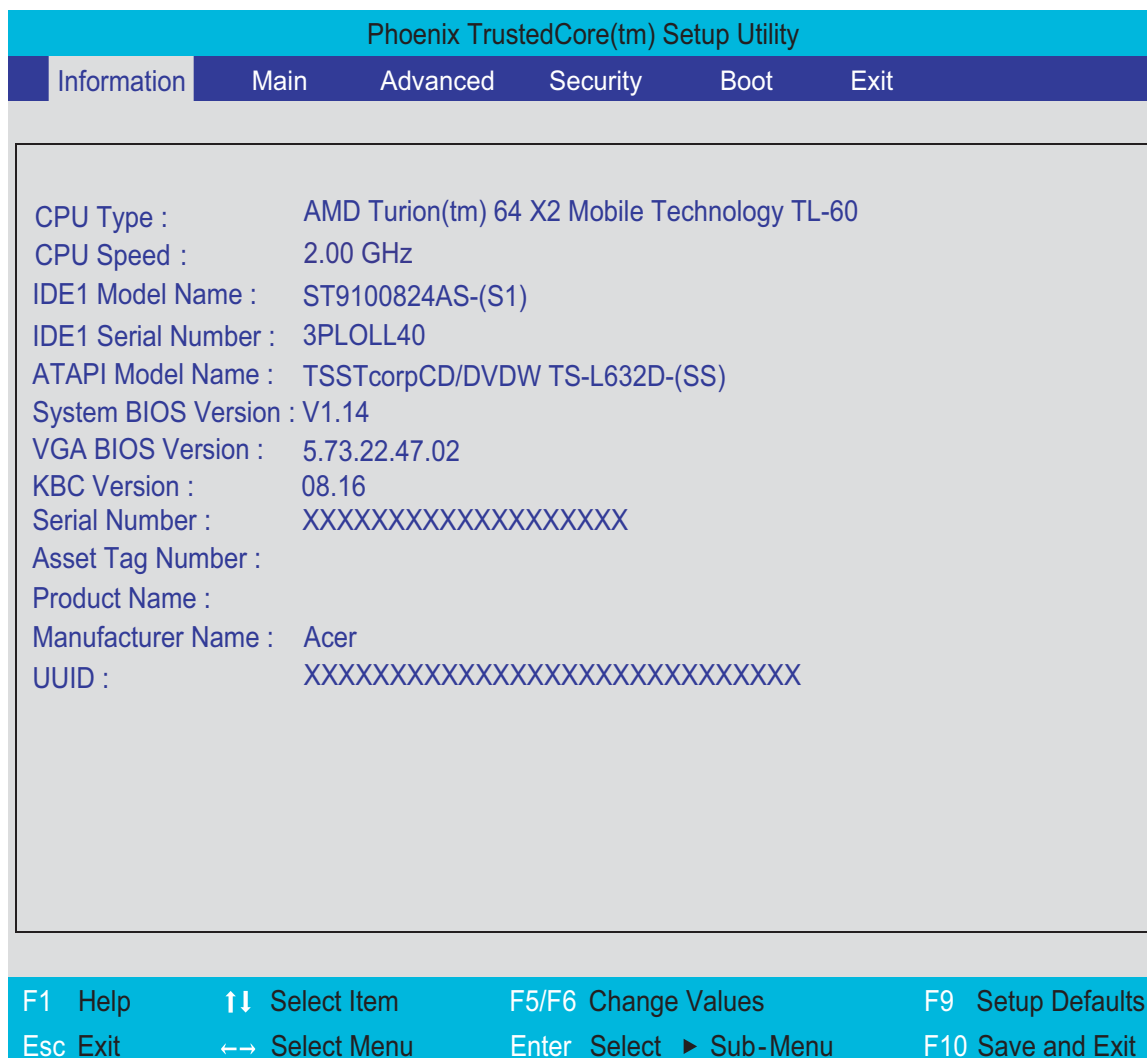

---

## Navigating the BIOS Utility

For the AS7220 model, there are six menu options: Information, Main, Advanced, Security, Boot, and Exit.

For the AS7250/G model, there are five menu options: Information, Main, Security, Boot, and Exit.

Follow these instructions:

- q To choose a menu, use the cursor left/right keys (zx).
- q To choose a parameter, use the cursor up/down keys (wy).
- q To change the value of a parameter, press p or q.
- q A plus sign (+) indicates the item has sub-items. Press e to expand this item.
- q Press ^ while you are in any of the menu options to go to the Exit menu.
- q In any menu, you can load default settings by pressing t. You can also press u to save any changes made and exit the BIOS Setup Utility.

**NOTE:** You can change the value of a parameter if it is enclosed in square brackets. Navigation keys for a particular menu are shown on the bottom of the screen. Help for parameters are found in the Item Specific Help part of the screen. Read this carefully when making changes to parameter values. **Please note that system information is subject to different models.**



# AS7220 Model BIOS Screens

See the following sections for descriptions of the BIOS screens on the AS7220 model laptops.

## Information

The screenshot displays the Phoenix TrustedCore(tm) Setup Utility interface. At the top, a blue header bar contains the title "Phoenix TrustedCore(tm) Setup Utility". Below this, a dark blue navigation bar features several menu options: "Information" (highlighted in white), "Main", "Advanced", "Security", "Boot", and "Exit". The main content area is a light gray box with a black border, containing the following system information:

- CPU Type : AMD Turion(tm) 64 X2 Mobile Technology TL-60
- CPU Speed : 2.00 GHz
- IDE1 Model Name : ST9100824AS-(S1)
- IDE1 Serial Number : 3PLOLL40
- ATAPI Model Name : TSSTcorpCD/DVDW TS-L632D-(SS)
- System BIOS Version : V1.14
- VGA BIOS Version : 5.73.22.47.02
- KBC Version : 08.16
- Serial Number : XXXXXXXXXXXXXXXXXXXXXXX
- Asset Tag Number :
- Product Name :
- Manufacturer Name : Acer
- UUID : XXXXXXXXXXXXXXXXXXXXXXXXXXXXXXX

At the bottom of the screen, a blue bar contains navigation instructions:

- F1 Help
- ↑↓ Select Item
- F5/F6 Change Values
- F9 Setup Defaults
- Esc Exit
- ↔ Select Menu
- Enter Select ▶ Sub-Menu
- F10 Save and Exit

**NOTE:** The system information is subject to different models

The table below describes the parameters in this screen. .

Parameter	Description
CPU Type / CPU Speed	This field shows the CPU type and speed of the system.
IDE1 Model Name	This field shows the model name of HDD installed on the primary IDE master.
IDE1 Serial Number	This field displays the serial number of HDD installed on the primary IDE master.
ATAPI Model Name	This field shows the model name of devices installed on the secondary IDE master. The hard disk drive or optical drive model name is automatically detected by the system.
System BIOS Version	Displays the system BIOS version.
VGA BIOS Version	This field displays the VGA firmware version of the system.
KBC Version	This field displays the KBC version of the system.
Serial Number	This field displays the serial number of this unit.
Asset Tag Number	This field displays the asset tag number of the system.
Product Name	This field shows product name of the system.
Manufacturer Name	This field displays the manufacturer of this system.
UUID	This will be visible only when an internal LAN device is present. UUID=32bytes

# Main

The Main screen displays a summary of your computer hardware information, and also includes basic setup parameters. It allows the user to specify standard IBM PC AT system parameters.

Phoenix TrustedCore(tm) Setup Utility					
Information	Main	Advanced	Security	Boot	Exit
System Time : [19:03:49] System Date : [10/17/2007]  System Memory : 633 KB Extended Memory : 1022 MB VGA Memory : 256 MB  Quiet Boot : [Enabled] Power on Display : [Auto] Network Boot : [Enabled] F12 Boot Menu : [Disabled] D2D Recovery : [Enabled]					Item Specific Help <Tab>, <Shift-Tab>, or <Enter> selects field.
					Shows system base memory size Shows extended memory size
F1 Help	↑↓ Select Item	F5/F6 Change Values		F9 Setup Defaults	
Esc Exit	←→ Select Menu	Enter Select ► Sub-Menu		F10 Save and Exit	

**NOTE:** The screen above is for your reference only. Actual values may differ.

The table below describes the parameters in this screen. Settings in **boldface** are the default and suggested parameter settings.

Parameter	Description	Format/Option
System Time	Sets the system time. The hours are displayed with 24-hour format.	Format: HH:MM:SS (hour:minute:second) System Time
System Date	Sets the system date.	Format MM/DD/YYYY (month/day/year) System Date
System Memory	This field reports the memory size of the system. Memory size is fixed to 633KB.	
Extended Memory	This field reports the total memory size in the system.	
VGA Memory	Shows the VGA memory size.	
Quiet Boot	Determines if Customer Logo will be displayed or not; shows Summary Screen is disabled or enabled.  Enabled: Customer Logo is displayed, and Summary Screen is disabled.  Disabled: Customer Logo is not displayed, and Summary Screen is enabled.	Option: <b>Enabled</b> or Disabled
Power on Display	Auto: During power process, the system will detect if any display device is connected on external video port. If any external display device is connected, the power on display will be in CRT (or projector) only mode. Otherwise it will be in LCD only mode.  Both: Simultaneously enable both the integrated LCD screen and the system's external video port (for an external CRT or projector).	Option: <b>Auto</b> or Both
Network Boot	Enables, disables the system boot from LAN (remote server).	Option: <b>Enabled</b> or Disabled
F12 Boot Menu	Enables, disables Boot Menu during POST.	Option: <b>Disabled</b> or Enabled
D2D Recovery	Enables, disables D2D Recovery function. The function allows the user to create a hidden partition on hard disc drive to store operation system and restore the system to factory defaults.	Option: <b>Enabled</b> or Disabled

**NOTE:** The sub-items under each device will not be shown if the device control is set to disable or auto. This is because the user is not allowed to control the settings in these cases.

# Advanced

The Advanced screen displays advanced settings in BIOS.

Phoenix TrustedCore(tm) Setup Utility

Information
Main
Advanced
Security
Boot
Exit

▶ Infrared Port (FIR): **[Enabled]**

Item Specific Help

Configure Infrared Port using options:

[Disabled]  
No configuration

[Enabled]  
User configuration

[Auto]  
BIOS or OS chooses configuration

(OS Controlled)  
Displayed when controlled by OS

F1 Help
↑↓ Select Item
F5/F6 Change Values
F9 Setup Defaults

Esc Exit
←→ Select Menu
Enter Select ▶ Sub-Menu
F10 Save and Exit

The table below describes the parameters in this screen. Settings in **boldface** are the default and suggested parameter settings.

Parameter	Description	Option
Infrared Port (FIR)	Enables, disables the Infrared port. Enabled: User controls port configuration. Auto: BIOS or OS controls port configuration. OS Controlled: This is displayed when port configuration is controlled by the OS.	<b>Enabled</b> , Disabled, Auto or OS Controlled

# Security

The Security screen contains parameters that help safeguard and protect your computer from unauthorized use.

Phoenix TrustedCore(tm) Setup Utility			
Information	Main	Advanced	Security
Boot	Exit		
Supervisor Password is : Clear User Password is : Clear SATA HDD Password is: Clear  Set Supervisor Password: [Enter] Set User Password: [Enter] Set SATA HDD Password [Enter]  Password on Boot : [Disabled]			<b>Item Specific Help</b>  Supervisor Password controls access of the whole setup utility. It can be used to boot up when Password on boot is enabled.
F1 Help	↑↓ Select Item	F5/F6 Change Values	F9 Setup Defaults
Esc Exit	←→ Select Menu	Enter Select ▶ Sub-Menu	F10 Save and Exit

The table below describes the parameters in this screen. Settings in **boldface** are the default and suggested parameter settings.

Parameter	Description	Option
Supervisor Password is	Shows the setting of the Supervisor password	<b>Clear</b> or Set
User Password is	Shows the setting of the user password.	<b>Clear</b> or Set
HDD Password	Shows the setting of the hard disk password.	<b>Clear</b> or Set
Set Supervisor Password	Press Enter to set the supervisor password. When set, this password protects the BIOS Setup Utility from unauthorized access. The user can not either enter the Setup menu nor change the value of parameters.	
Set User Password	Press Enter to set the user password. When user password is set, this password protects the BIOS Setup Utility from unauthorized access. The user can enter Setup menu only and does not have right to change the value of parameters.	
Set SATA HDD Password	Press Enter to set the hard disk password. When set, this password protects the BIOS Setup Utility from unauthorized access. The user can not either enter the Setup menu nor change the value of parameters.	
Password on Boot	Defines whether a password is required or not while the events defined in this group happened. The following sub-options are all requires the Supervisor password for changes and should be grayed out if the user password was used to enter setup.	<b>Disabled</b> or Enabled

**NOTE:** When you are prompted to enter a password, you have three tries before the system halts. Don't forget your password. If you forget your password, you may have to return your notebook computer to your dealer to reset it.

## Setting a Password

Follow these steps as you set the supervisor, user, or hard disk password:

1. Use the **w** and **y** keys to highlight the Set Supervisor Password parameter and press the **e** key. The Set Supervisor Password box appears:

Set Supervisor Password

Enter New Password [                    ]

Confirm New Password [                    ]

2. Type a password in the "Enter New Password" field. The password length can not exceed 8 alphanumeric characters (A-Z, a-z, 0-9, not case sensitive). Retype the password in the "Confirm New Password" field.

**IMPORTANT:** Be very careful when typing your password because the characters do not appear on the screen.

3. Press **e**. After setting the password, the computer sets the Supervisor Password parameter to "Set".
4. If desired, you can opt to enable the Password on boot parameter.
5. When you are done, press **u** to save the changes and exit the BIOS Setup Utility.

---

## Removing a Password

Follow these steps:

1. Use the **w** and **y** keys to highlight the Set Supervisor Password parameter and press the **e** key. The Set Supervisor Password box appears:

Set Supervisor Password		
Enter current password	[	]
Enter New Password	[	]
Confirm New Password	[	]

2. Type the current password in the Enter Current Password field and press **e**.
3. Press **e** twice **without** typing anything in the Enter New Password and Confirm New Password fields. The computer then sets the Supervisor Password parameter to "Clear".
4. When you have changed the settings, press **u** to save the changes and exit the BIOS Setup Utility.

## Changing a Password

1. Use the **w** and **y** keys to highlight the Set Supervisor Password parameter and press the **e** key. The Set Supervisor Password box appears:

Set Supervisor Password		
Enter current password	[	]
Enter New Password	[	]
Confirm New Password	[	]

2. Type the current password in the Enter Current Password field and press **e**.
3. Type a password in the Enter New Password field. Retype the password in the Confirm New Password field.
4. Press **e**. After setting the password, the computer sets the Supervisor Password parameter to "Set".
5. If desired, you can enable the Password on boot parameter.
6. When you are done, press **u** to save the changes and exit the BIOS Setup Utility.

If the verification is OK, the screen will display as following.

Setup Notice
Changes have been saved.
[ continue]

The password setting is complete after the user presses **u**.



---

If the current password entered does not match the actual current password, the screen will show you the Setup Warning.

Setup Warning  
Invalid password  
Re-enter Password  
[ continue]

If the new password and confirm new password strings do not match, the screen will display the following message.

Setup Warning  
Password do not match  
Re-enter Password

# Boot

This menu allows the user to decide the order of boot devices to load the operating system. Bootable devices includes the diskette drive in module bay, the onboard hard disk drive, and the CD-ROM in module bay.

Phoenix TrustedCore(tm) Setup Utility					
Information	Main	Advanced	Security	Boot	Exit
<p>Boot priority order:</p> <ul style="list-style-type: none"><li>1: IDE CDROM : TSSTcorpCD/DVDW TS-L632D-(</li><li>2: IDE HDD: ST9100824AS-(S1)</li><li>4: PCI LAN : NVIDIA Boot Agent 232.0529</li><li>4: USB HDD :</li><li>5: USB CDROM :</li><li>6: USB FDC :</li><li>7: USB KEY :</li></ul>				<p>Item Specific Help</p> <p>Use &lt;↑&gt; or &lt;↓&gt; to select a device, then press &lt;F6&gt; to move it up the list, or &lt;F5&gt; to move it down the list. Press &lt;Esc&gt; to escape the menu.</p>	
F1 Help	↑↓ Select Item	F5/F6 Change Values	F9 Setup Defaults		
Esc Exit	←→ Select Menu	Enter Select ▶ Sub-Menu	F10 Save and Exit		

# Exit

The Exit screen contains parameters that help safeguard and protect your computer from unauthorized use.

Phoenix TrustedCore(tm) setup Utility					
Information	Main	Advanced	Security	Boot	Exit
Exit Saving Changes Exit Discarding Changes Load Setup Defaults Discard Changes Save Changes					Item Specific Help  Exit System Setup and save your changes to CMOS.
F1 Help	↑↓ Select Item	F5/F6 Change Values	F9 Setup Defaults		
Esc Exit	←→ Select Menu	Enter Execute Command	F10 Save and Exit		

The table below describes the parameters in this screen.

Parameter	Description
Exit Saving Changes	Exit System Setup and save your changes to CMOS.
Exit Discarding Changes	Exit utility without saving setup data to CMOS.
Load Setup Defaults	Load default values for all SETUP item.
Discard Changes	Load previous values from CMOS for all SETUP items.
Save Changes	Save Setup Data to CMOS.

# AS7250/G Model BIOS Screens

See the following sections for descriptions of the BIOS screens on the AS7250 and AS7250G model laptops.

## Information

The screenshot displays the Phoenix TrustedCore(tm) Setup Utility interface. At the top, there is a title bar with the text "Phoenix TrustedCore(tm) Setup Utility". Below this is a navigation menu with six options: "Information", "Main", "Advanced", "Security", "Boot", and "Exit". The "Information" option is currently selected. The main area of the screen shows the following system information:

- CPU Type : AMD Turion(tm) 64 X2 Mobile Technology TL-60
- CPU Speed : 2.00 GHz
- IDE1 Model Name : ST9100824AS-(S1)
- IDE1 Serial Number : 3PLOLL40
- ATAPI Model Name : TSSTcorpCD/DVDW TS-L632D-(SS)
- System BIOS Version : V1.14
- VGA BIOS Version : 5.73.22.47.02
- KBC Version : 08.16
- Serial Number : XXXXXXXXXXXXXXXXXXXXXXX
- Asset Tag Number :
- Product Name :
- Manufacturer Name : Acer
- UUID : XXXXXXXXXXXXXXXXXXXXXXXXXXXXXXX

At the bottom of the screen, there is a legend for navigation keys:

- F1 Help
- ↑↓ Select Item
- F5/F6 Change Values
- F9 Setup Defaults
- Esc Exit
- ←→ Select Menu
- Enter Select ► Sub-Menu
- F10 Save and Exit

**NOTE:** The system information is subject to different models

The table below describes the parameters in this screen. .

Parameter	Description
CPU Type / CPU Speed	This field shows the CPU type and speed of the system.
HDD Model Name (PM)	This field shows the model name of HDD installed on the primary IDE master.
HDD Serial Number	This field displays the serial number of HDD installed on the primary IDE master.
HDD Model Name (PS)	This field shows the model name of HDD installed on the primary IDE slave.
HDD Serial Number	This field displays the serial number of HDD installed on the primary IDE slave.
ATAPI Model Name	This field shows the model name of devices installed on the secondary IDE master. The hard disk drive or optical drive model name is automatically detected by the system.
ATAPI Serial Number	This field shows the serial number of devices installed on the secondary IDE master. The hard disk drive or optical drive model name is automatically detected by the system.
System BIOS Version	Displays the system BIOS version.
VGA BIOS Version	This field displays the VGA firmware version of the system.
Serial Number	This field displays the serial number of this unit.
Asset Tag Number	This field displays the asset tag number of the system.
Product Name	This field shows product name of the system.
Manufacturer Name	This field displays the manufacturer of this system.
UUID	This will be visible only when an internal LAN device is present. UUID=32bytes

# Main

The Main screen displays a summary of your computer hardware information, and also includes basic setup parameters. It allows the user to specify standard IBM PC AT system parameters.

Phoenix TrustedCore(tm) Setup Utility					
Information	Main	Advanced	Security	Boot	Exit
System Time : [19:03:49] System Date : [10/17/2007]  System Memory : 633 KB Extended Memory : 1022 MB VGA Memory : 256 MB  Quiet Boot : [Enabled] Power on Display : [Auto] Network Boot : [Enabled] F12 Boot Menu : [Disabled] D2D Recovery : [Enabled]					Item Specific Help <Tab>, <Shift-Tab>, or <Enter> selects field.
Shows system base memory size Shows extended memory size					
F1 Help	↑↓ Select Item	F5/F6 Change Values		F9 Setup Defaults	
Esc Exit	←→ Select Menu	Enter Select ► Sub-Menu		F10 Save and Exit	

**NOTE:** The screen above is for your reference only. Actual values may differ.

The table below describes the parameters in this screen. Settings in **boldface** are the default and suggested parameter settings.

Parameter	Description	Format/Option
System Time	Sets the system time. The hours are displayed with 24-hour format.	Format: HH:MM:SS (hour:minute:second) System Time
System Date	Sets the system date.	Format MM/DD/YYYY (month/day/year) System Date
System Memory	This field reports the memory size of the system. Memory size is fixed to 634KB.	
Extended Memory	This field reports the total memory size in the system.	
Video Memory	Shows the video memory size.	
Quiet Boot	Determines if Customer Logo will be displayed or not; shows Summary Screen is disabled or enabled.  Enabled: Customer Logo is displayed, and Summary Screen is disabled.  Disabled: Customer Logo is not displayed, and Summary Screen is enabled.	Option: <b>Enabled</b> or Disabled
Network Boot	Enables, disables the system boot from LAN (remote server).	Option: <b>Enabled</b> or Disabled
F12 Boot Menu	Enables, disables Boot Menu during POST.	Option: <b>Disabled</b> or Enabled
D2D Recovery	Enables, disables D2D Recovery function. The function allows the user to create a hidden partition on hard disc drive to store operation system and restore the system to factory defaults.	Option: <b>Enabled</b> or Disabled

**NOTE:** The sub-items under each device will not be shown if the device control is set to disable or auto. This is because the user is not allowed to control the settings in these cases.

# Security

The Security screen contains parameters that help safeguard and protect your computer from unauthorized use.

Phoenix TrustedCore(tm) Setup Utility					
Information	Main	Advanced	Security	Boot	Exit
Supervisor Password is : Clear User Password is : Clear SATA HDD Password is: Clear  Set Supervisor Password: [Enter] Set User Password: [Enter] Set SATA HDD Password [Enter]  Password on Boot : [Disabled]					<b>Item Specific Help</b>  Supervisor Password controls access of the whole setup utility. It can be used to boot up when Password on boot is enabled.
F1 Help	↑↓	Select Item	F5/F6	Change Values	F9 Setup Defaults
Esc Exit	←→	Select Menu	Enter	Select ► Sub-Menu	F10 Save and Exit



The table below describes the parameters in this screen. Settings in **boldface** are the default and suggested parameter settings.

Parameter	Description	Option
Supervisor Password is	Shows the setting of the Supervisor password	<b>Clear</b> or Set
User Password is	Shows the setting of the user password.	<b>Clear</b> or Set
HDD 0 Password	Shows the setting of the hard disk 0 password.	<b>Clear</b> or Set
HDD 1 Password	Shows the setting of the hard disk 1 password.	<b>Clear</b> or Set
Set Supervisor Password	Press Enter to set the supervisor password. When set, this password protects the BIOS Setup Utility from unauthorized access. The user can not either enter the Setup menu nor change the value of parameters.	
Set User Password	Press Enter to set the user password. When user password is set, this password protects the BIOS Setup Utility from unauthorized access. The user can enter Setup menu only and does not have right to change the value of parameters.	
Set HDD 0 Password	Press Enter to set the hard disk 0 password. When set, this password protects the BIOS Setup Utility from unauthorized access. The user can not either enter the Setup menu nor change the value of parameters.	
Set HDD 1 Password	Press Enter to set the hard disk 1 password. When set, this password protects the BIOS Setup Utility from unauthorized access. The user can not either enter the Setup menu nor change the value of parameters.	
Password on Boot	Defines whether a password is required or not while the events defined in this group happened. The following sub-options are all requires the Supervisor password for changes and should be grayed out if the user password was used to enter setup.	<b>Disabled</b> or Enabled

**NOTE:** When you are prompted to enter a password, you have three tries before the system halts. Don't forget your password. If you forget your password, you may have to return your notebook computer to your dealer to reset it.

## Setting a Password

Follow these steps as you set the supervisor, user, or hard disk password:

1. Use the **w** and **y** keys to highlight the Set Supervisor Password parameter and press the **e** key. The Set Supervisor Password box appears:

Set Supervisor Password

Enter New Password    [                    ]

Confirm New Password    [                    ]

2. Type a password in the "Enter New Password" field. The password length can not exceed 8 alphanumeric characters (A-Z, a-z, 0-9, not case sensitive). Retype the password in the "Confirm New Password" field.

---

**IMPORTANT:** Be very careful when typing your password because the characters do not appear on the screen.

3. Press **e**. After setting the password, the computer sets the Supervisor Password parameter to “Set”.
4. If desired, you can opt to enable the Password on boot parameter.
5. When you are done, press **u** to save the changes and exit the BIOS Setup Utility.

## Removing a Password

Follow these steps:

1. Use the **w** and **y** keys to highlight the Set Supervisor Password parameter and press the **e** key. The Set Supervisor Password box appears:

Set Supervisor Password		
Enter current password	[	]
Enter New Password	[	]
Confirm New Password	[	]

2. Type the current password in the Enter Current Password field and press **e**.
3. Press **e** twice **without** typing anything in the Enter New Password and Confirm New Password fields. The computer then sets the Supervisor Password parameter to “Clear”.
4. When you have changed the settings, press **u** to save the changes and exit the BIOS Setup Utility.

## Changing a Password

1. Use the **w** and **y** keys to highlight the Set Supervisor Password parameter and press the **e** key. The Set Supervisor Password box appears:

Set Supervisor Password		
Enter current password	[	]
Enter New Password	[	]
Confirm New Password	[	]

2. Type the current password in the Enter Current Password field and press **e**.
3. Type a password in the Enter New Password field. Retype the password in the Confirm New Password field.
4. Press **e**. After setting the password, the computer sets the Supervisor Password parameter to “Set”.
5. If desired, you can enable the Password on boot parameter.
6. When you are done, press **u** to save the changes and exit the BIOS Setup Utility.

---

If the verification is OK, the screen will display as following.

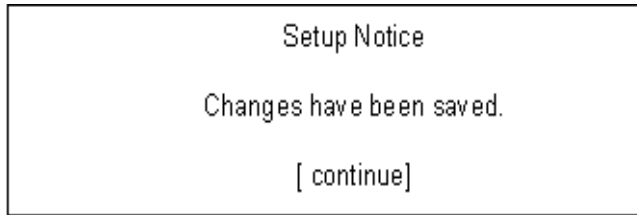

The password setting is complete after the user presses u.

If the current password entered does not match the actual current password, the screen will show you the Setup Warning.

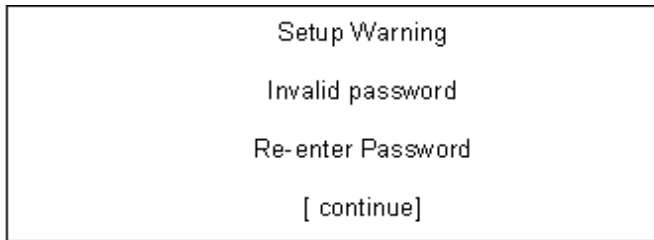

If the new password and confirm new password strings do not match, the screen will display the following message.

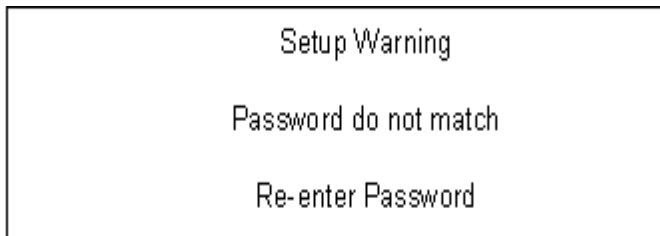

# Boot

This menu allows the user to decide the order of boot devices to load the operating system. Bootable devices includes the diskette drive in module bay, the onboard hard disk drive, and the CD-ROM in module bay.

<p>Boot priority order:</p> <ul style="list-style-type: none"><li>1: IDE CDROM : TSSTcorpCD/DVDW TS-L632D-(</li><li>2: IDE HDD: ST9100824AS-(S1)</li><li>4: PCI LAN : NVIDIA Boot Agent 232.0529</li><li>4: USB HDD :</li><li>5: USB CDROM :</li><li>6: USB FDC :</li><li>7: USB KEY :</li></ul>	<p>Item Specific Help</p> <p>Use &lt;↑&gt; or &lt;↓&gt; to select a device, then press &lt;F6&gt; to move it up the list, or &lt;F5&gt; to move it down the list. Press &lt;Esc&gt; to escape the menu.</p>
<p>F1 Help      ↑↓ Select Item      F5/F6 Change Values      F9 Setup Defaults Esc Exit      ↔ Select Menu      Enter Select ▶ Sub-Menu      F10 Save and Exit</p>	

# Exit

The Exit screen contains parameters that help safeguard and protect your computer from unauthorized use.

<p>Exit Saving Changes  Exit Discarding Changes  Load Setup Defaults  Discard Changes  Save Changes</p>	<p>Item Specific Help</p>
	<p>Exit System Setup and save your changes to CMOS.</p>
<p>F1 Help      ↑↓ Select Item      F5/F6 Change Values      F9 Setup Defaults  Esc Exit      ←→ Select Menu      Enter Execute Command      F10 Save and Exit</p>	

The table below describes the parameters in this screen.

Parameter	Description
Exit Saving Changes	Press Enter to exit the utility and save your changes to CMOS.
Exit Discarding Changes	Press Enter to exit the utility without saving setup data to CMOS.
Load Setup Defaults	Press Enter to load default values for all setup parameters.
Discard Changes	Press Enter to load previous values from CMOS for setup parameters.
Save Changes	Press Enter to save setup data to CMOS.



# Machine Disassembly and Replacement

---

This chapter contains step-by-step procedures on how to disassemble the notebook computer for maintenance and troubleshooting.

To disassemble the computer, you need the following tools:

- q Wrist grounding strap and conductive mat for preventing electrostatic discharge
- q Small Philips screw driver
- q Philips screwdriver
- q Plastic flat head screw driver
- q Tweezers

**NOTE:** The screws for the different components vary in size. During the disassembly process, group the screws with the corresponding components to avoid mismatch when putting back the components. When you remove the stripe cover, please be careful not to scrape the cover.

---

## General Information

### Before You Begin

Before proceeding with the disassembly procedure, make sure that you do the following:

1. Turn off the power to the system and all peripherals.
2. Unplug the AC adapter and all power and signal cables from the system.
3. Remove the battery pack.



# Disassembly Procedure Flowchart

The flowchart on the succeeding page gives you a graphic representation on the entire disassembly sequence and instructs you on the components that need to be removed during servicing. For example, if you want to remove the system board, you must first remove the keyboard, then disassemble the inside assembly frame in that order.

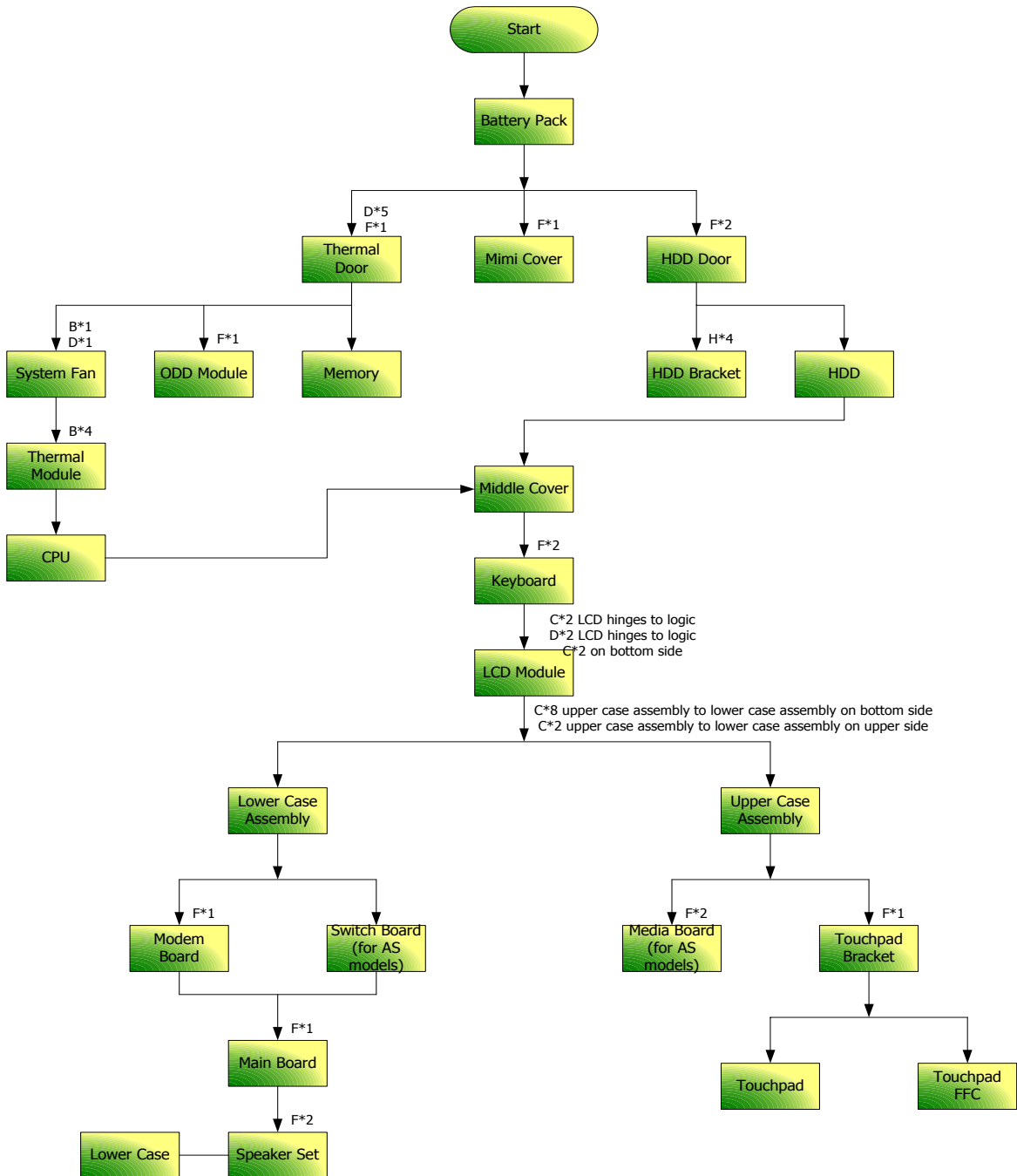

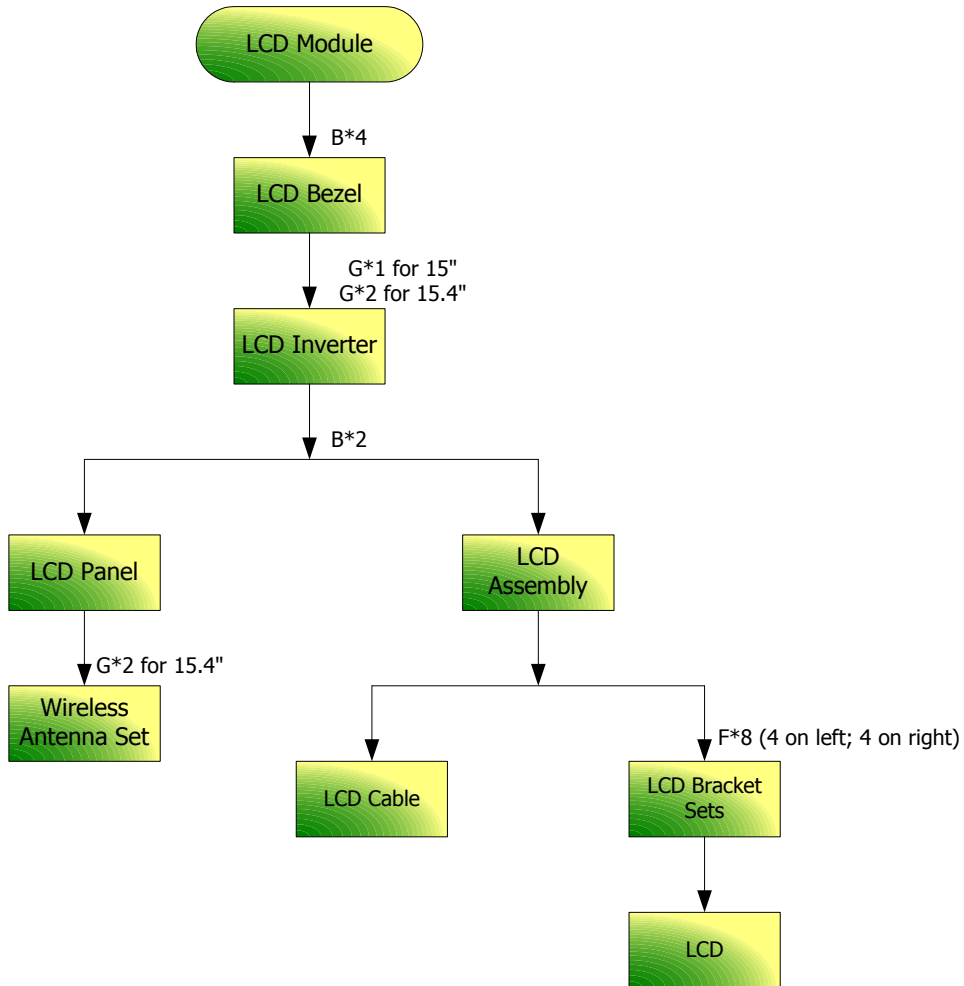

**Screw List**

Item	Description	Part Number
A	SCREW M2.5*3(NL)	MA000006AG0
B	SCREW M2.5*4(NL)	MA0000061G0
B	SCREW M2.5*6(NL)	MA0000062G0
D	SCREW M2.5*12(NL)	MMCK25120G0
E	SCREW M2*2.2	MA000006UG0
F	SCREW M2*3(NL)	MA0000060G0
G	SCREW M2*5(Ni-NL)	MA0000012G0
H	SCREW M M 3.0D 3.0L K	MAAA03032G0
I	SCREW M 2.5D 4.15L K 5.5D ZK NL	MA0000005G0
J	SCREW M 2.5D 3.2L K 6D NI +	MA000006C00
K	SCREW ICW50_CPU_T HERMAL_SCR	AM010000300
L	SCREW M M 2.0D 3L K 5D	MA0000096G0
M	SCREW F 4# 5L K 4.5D ZK NL +	MA000002NG0

---

## Removing the Battery Pack

1. Unlock the battery lock (move the battery lock to the unlock position as shown).
2. Slide the battery release latch then remove the battery.



---

# Removing the HDD Module/Memory/Wireless LAN Card/Modem Card/System Fan/Thermal Modules/VGA Board/CPU/Keyboard and the LCD Module

## Removing the HDD Module

1. Remove the two screws fastening the HDD cover.
2. Detach the HDD cover from the main unit.
3. Remove the screw fastening the HDD module bracket.
4. Pull the tab to remove the HDD module in the direction of the arrow.

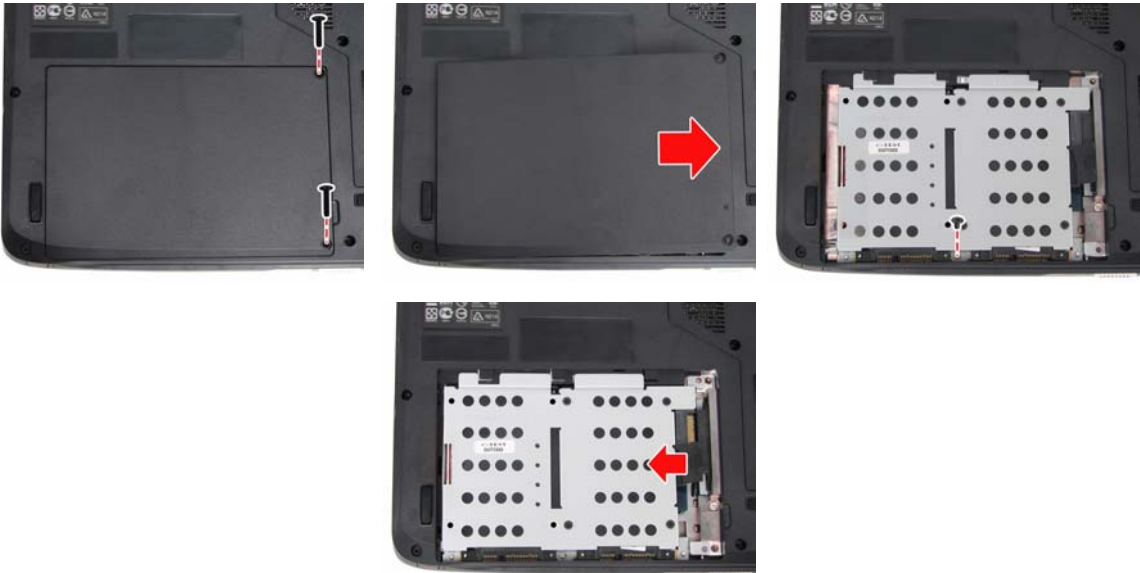

## Removing the Memory

1. Remove the four screws holding the thermal cover.
2. Detach the thermal cover from the main unit.
3. Pop out the memory from the DIMM socket then remove it (If the notebook has two memory, then repeat this step).



---

## Removing the Wireless LAN Card/Modem Card and TV Tuner Card

1. Disconnect the two antennae from the wireless LAN card.
2. Remove the two screws fastening the wireless LAN card.
3. Then take out the wireless LAN card from the main unit.



4. Remove the two screws fastening the modem card and detach the modem card from the main board.
5. Then remove the modem card from the main unit.

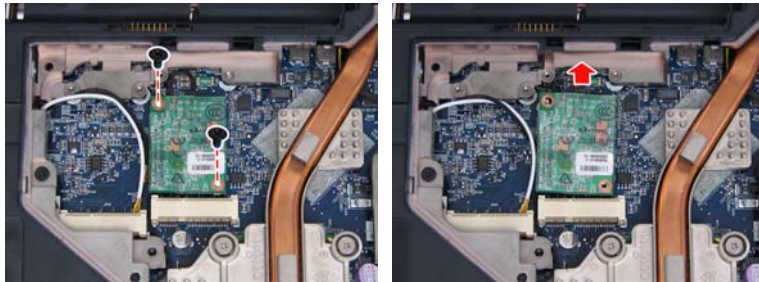

---

## Removing the System Fan/Thermal Modules/VGA Board and CPU

1. Disconnect the fan cable from the main board.
2. Remove the three screws holding the system fan.



3. Remove the four spring screws holding the CPU thermal module.
4. Then detach the CPU thermal module as shown.



5. Use a flat screwdriver to release the CPU lock (Turn counter clock-wise).
6. Remove the CPU from the CPU socket carefully.

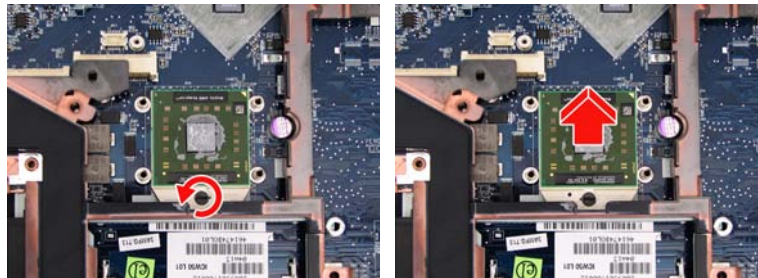



---

## Removing the Keyboard and LCD Module

1. Turn the notebook over.
2. Remove the two screws securing the strip cover from the bottom of the notebook.
3. Detach the strip cover from the front side and remove it.
4. Gently pull up the keyboard to release it from the four snaps as shown.



5. Turn over the keyboard as the image shows. Then disconnect the keyboard cable from the main board.
6. Remove the keyboard from the main unit.
7. Disconnect the LCD cable and microphone cable from the main board.

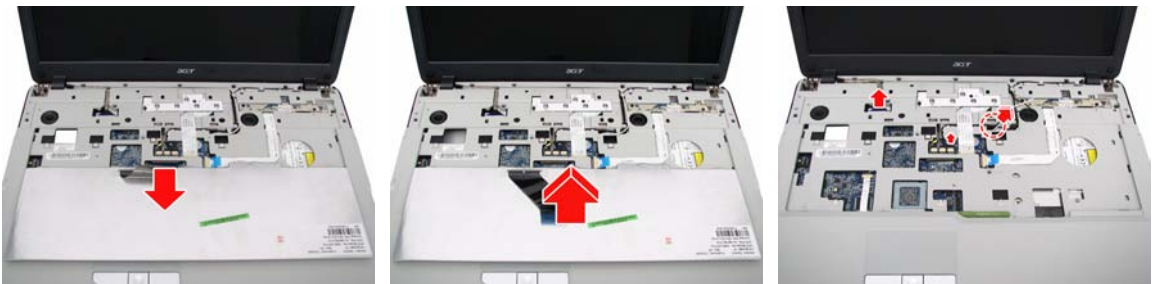

8. Pull out the wireless LAN antennas free from the main unit as shown.
9. Remove the four screws securing the hinges.
10. Detach the LCD module from the main unit.



---

## Disassembling the Main Unit

### Separate the Main Unit Into the Upper and the Lower Case Assembly

1. Remove the screw fastening the ODD from the bottom of the notebook.
2. Push the ODD module outwards and gently pull it out as shown.



3. Press and release the PC dummy card from the PC slot as shown.



4. Then press the release the memory dummy card from the 5-in-1 card reader slot as shown.



5. Remove the nine screws fastening the upper case and the lower case assembly on the bottom.
6. Remove the eight screws fastening the upper case assembly and the lower case assembly on the front side.





7. Disconnect the touchpad FFC, left speaker cable, button board FFC, and LED board FFC from the main board.
8. Carefully detach the upper case assembly from the lower case assembly.



### Disassembling the Lower Case Assembly

1. Remove the two screws fastening the audio board to the lower case.
2. Detach the audio board cable from the main board.
3. Remove the audio board from the main unit.



1. Disconnect the USB cable from the main board.
2. Remove the screw fastening the USB board and take out the board and its cable from the lower case.
3. Then detach the USB cable from the USB board.

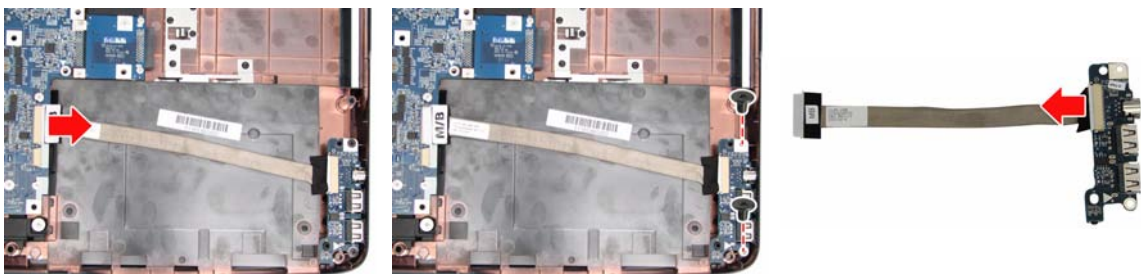

4. Pull the RF board cable free from the main unit.
5. Remove the screw fastening the RF board to the lower case assembly.

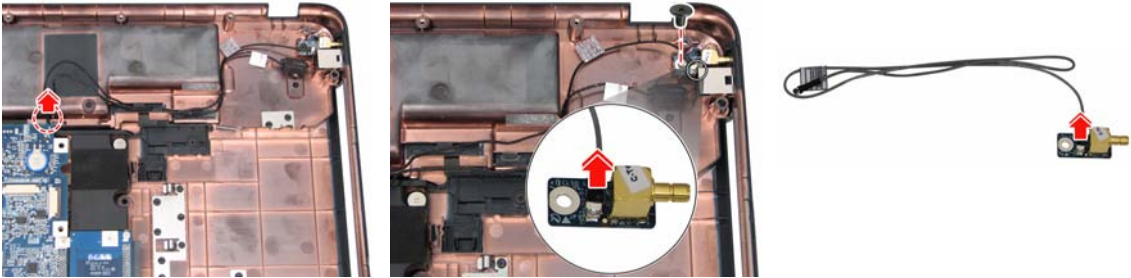

6. Remove the four screws fastening the ODD board to the main board.
7. Take out the ODD board as shown.

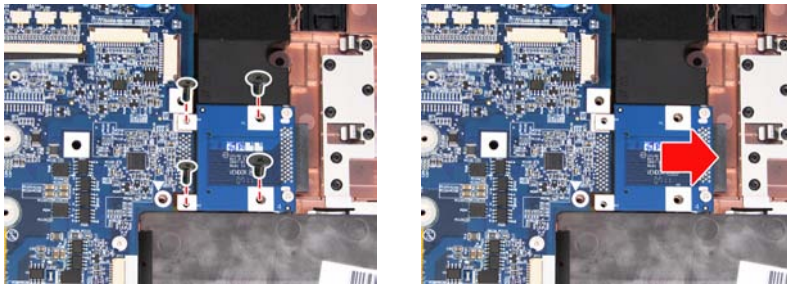

8. Remove the four screws fastening the main board to the lower case.
9. Detach the main board from the lower case as shown.
10. Turn the main board over, then remove the DC-in connector from the board as shown.

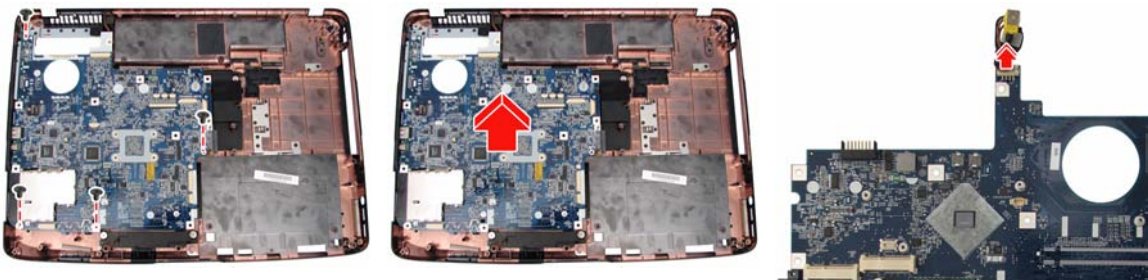

11. Remove the three screws fastening the subwoofer to the lower case.
12. Remove the subwoofer as shown.



---

## Disassembling the Upper Case Assembly

1. Turn the upper case over.
2. Remove the two screws fastening the button board.
3. Detach the button board with FFC from the upper case as shown.

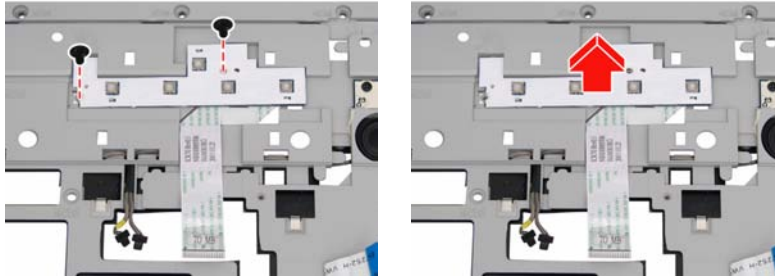

4. Remove the two screws fastening the LED board.
5. Detach the LED board with FFC from the upper case as shown.

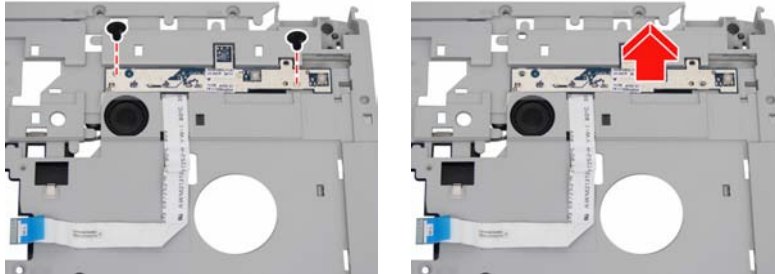

6. Remove the four screws fastening the speakers.
7. Remove the speakers from the upper case as shown.

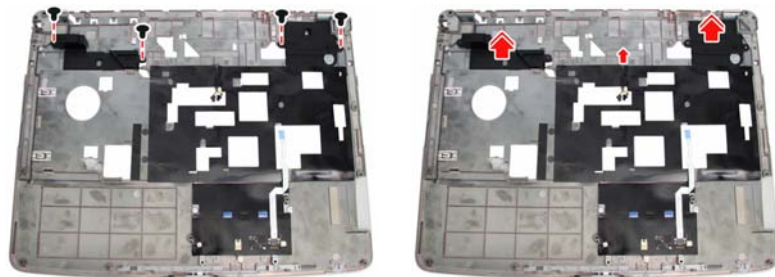

---

## Disassembling the LCD Module

1. Remove the four screw rubbers as shown.
2. Then remove the four screws fastening the LCD bezel.
3. Detach the LCD bezel from the LCD module carefully.



4. Remove the four screws holding the LCD to the LCD panel.
5. Detach the CCD cable connector from the CCD board.
6. Take out the CCD module from the LCD panel.



7. Remove the screw fastening the CCD board to the CCD bracket.
8. Lift out the LCD from the LCD panel as shown.
9. Detach the two inverter cable connectors from the inverter board.

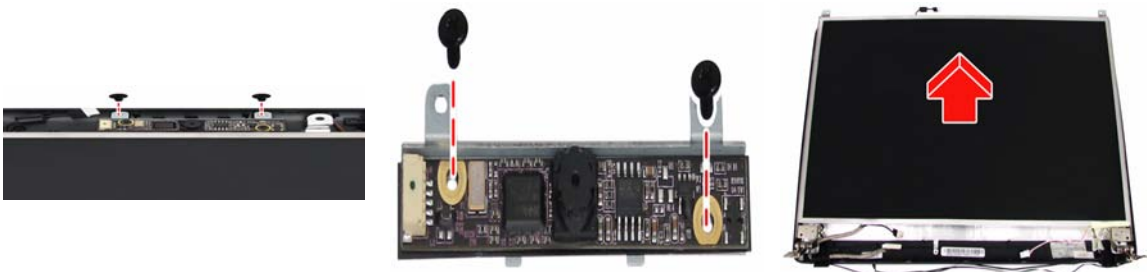

- 
10. Remove the four screws fastening the left LCD bracket and detach it.
  11. Remove the four screws fastening the right LCD bracket and detach it.
  12. Disconnect the LCD cable from the rear side of the LCD.

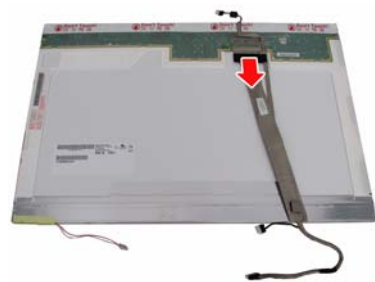
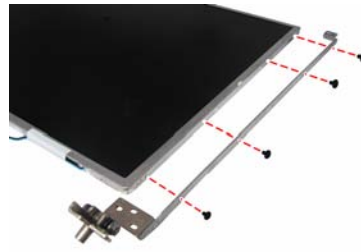
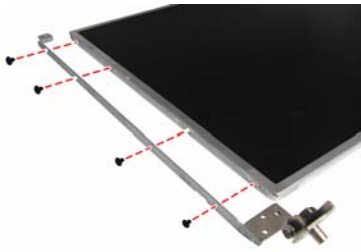



---

## Disassembling the External Modules

### Disassembling the HDD Module

1. Remove the four screws holding the HDD (hard disk drive) case; two on each side.
2. Carefully slide out the hard disk drive from the HDD case.



### Disassembling the ODD Module

1. Remove the three screws holding the optical bracket.
2. Then remove the optical bracket from the optical disk drive.







# Troubleshooting

Use the following procedure as a guide for computer problems.

**NOTE:** The diagnostic tests are intended to test only Acer products. Non-Acer products, prototype cards, or modified options can give false errors and invalid system responses.

1. Obtain the failing symptoms in as much detail as possible.
2. Verify the symptoms by attempting to re-create the failure by running the diagnostic test or by repeating the same operation.
3. Use the following table with the verified symptom to determine which page to go to.

Symptoms (Verified)	Go To
Power failure (The power indicator does not go on or stay on).	"Power System Check" on page 77
POST does not complete. No beep or error codes are indicated.	"Power-On Self-Test (POST) Error Message" on page 80 "Undetermined Problems" on page 92
POST detects an error and displayed messages on screen.	"Error Message List" on page 81
Other symptoms (i.e. LCD display problems or others).	"Power-On Self-Test (POST) Error Message" on page 80
Symptoms cannot be re-created (intermittent problems).	Use the customer-reported symptoms and go to "Power-On Self-Test (POST) Error Message" on page 80 "Intermittent Problems" on page 91 "Undetermined Problems" on page 92

---

# System Check Procedures

## External Diskette Drive Check

Do the following to isolate the problem to a controller, driver, or diskette. A write-enabled, diagnostic diskette is required.

**NOTE:** Make sure that the diskette does not have more than one label attached to it. Multiple labels can cause damage to the drive or cause the drive to fail.

Do the following to select the test device:

1. Boot from the diagnostics diskette and start the diagnostics program.
2. See if FDD Test is passed as the program runs to FDD Test.
3. Follow the instructions in the message window.

If an error occurs with the internal diskette drive, reconnect the diskette connector on the system board.

If the error still remains:

1. Reconnect the external diskette drive/DVD-ROM module.
2. Replace the external diskette drive/CD-ROM module.
3. Replace the main board.

## External CD-ROM Drive Check

Do the following to isolate the problem to a controller, drive, or CD-ROM. Make sure that the CD-ROM does not have any label attached to it. The label can cause damage to the drive or can cause the drive to fail.

Do the following to select the test device:

1. Boot from the diagnostics diskette and start the diagnostics program.
2. See if CD-ROM Test is passed when the program runs to CD-ROM Test.
3. Follow the instructions in the message window.

If an error occurs, reconnect the connector on the System board. If the error still remains:

1. Reconnect the external diskette drive/CD-ROM module.
2. Replace the external diskette drive/CD-ROM module.
3. Replace the main board.

## Keyboard or Auxiliary Input Device Check

Remove the external keyboard if the internal keyboard is to be tested.

If the internal keyboard does not work or an unexpected character appears, make sure that the flexible cable extending from the keyboard is correctly seated in the connector on the system board.

If the keyboard cable connection is correct, run the Keyboard Test.

If the tests detect a keyboard problem, do the following one at a time to correct the problem. Do not replace a non-defective FRU:

1. Reconnect the keyboard cables.
2. Replace the keyboard.
3. Replace the main board.

The following auxiliary input devices are supported by this computer:

- q Numeric keypad
- q External keyboard

---

If any of these devices do not work, reconnect the cable connector and repeat the failing operation.

## Memory check

Memory errors might stop system operations, show error messages on the screen, or hang the system.

1. Boot from the diagnostics diskette and start the doagmpstotics program (please refer to main board).
2. Go to the diagnostic memory in the test items.
3. Press F2 in the test items.
4. Follow the instructions in the message window.

**NOTE:** Make sure that the DIMM is fully installed into the connector. A loose connection can cause an error.

## Power System Check

To verify the symptom of the problem, power on the computer using each of the following power sources:

1. Remove the battery pack.
2. Connect the power adapter and check that power is supplied.
3. Disconnect the power adapter and install the charged battery pack; then check that power is supplied by the battery pack.

If you suspect a power problem, see the appropriate power supply check in the following list:

- q “Check the Power Adapter” on page 78
- q “Check the Battery Pack” on page 79

---

## Check the Power Adapter

Unplug the power adapter cable from the computer and measure the output voltage at the plug of the power adapter cable. See the following figure:

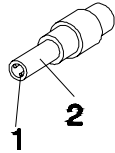

Pin 1: +19 to +20.5V  
Pin 2: 0V, Ground

1. If the voltage is not correct, replace the power adapter.
2. If the voltage is within the range, do the following:
  - q Replace the System board.
  - q If the problem is not corrected, see “Undetermined Problems” on page 92.
  - q If the voltage is not correct, go to the next step.

**NOTE:** An audible noise from the power adapter does not always indicate a defect.

3. If the power-on indicator does not light up, check the power cord of the power adapter for correct continuity and installation.
4. If the operational charge does not work, see “Check the Battery Pack” on page 79.

---

## Check the Battery Pack

To check the battery pack, do the following:

From Software:

1. Check out the Power Management in Control Panel
2. In Power Meter, confirm that if the parameters shown in the screen for Current Power Source and Total Battery Power Remaining are correct.
3. Repeat the steps 1 and 2, for both battery and adapter.
4. This helps you identify first the problem is on recharging or discharging.

From Hardware:

1. Power off the computer.
2. Remove the battery pack and measure the voltage between battery terminals 1(+) and 6(ground). See the following figure

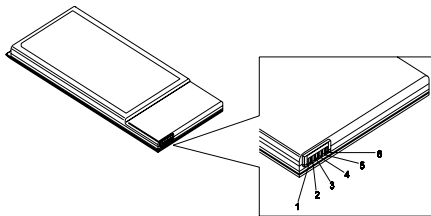

3. If the voltage is still less than 7.5 Vdc after recharging, replace the battery.

To check the battery charge operation, use a discharged battery pack or a battery pack that has less than 50% of the total power remaining when installed in the computer.

If the battery status indicator does not light up, remove the battery pack and let it return to room temperature. Re-install the battery pack.

If the charge indicator still does not light up, replace the battery pack. If the charge indicator still does not light up, replace the DC/DC charger board.

## Touchpad Check

If the touchpad doesn't work, do the following actions one at a time to correct the problem. Do not replace a non-defective FRU:

1. Reconnect the touchpad cables.
2. Replace the touchpad.
3. Replace the system board.

After you use the touchpad, the pointer drifts on the screen for a short time. This self-acting pointer movement can occur when a slight, steady pressure is applied to the touchpad pointer. This symptom is not a hardware problem. No service actions are necessary if the pointer movement stops in a short period of time.

---

# Power-On Self-Test (POST) Error Message

The POST error message index lists the error message and their possible causes. The most likely cause is listed first.

**NOTE:** Perform the FRU replacement or actions in the sequence shown in FRU/Action column, if the FRU replacement does not solve the problem, put the original part back in the computer. Do not replace a non-defective FRU.

This index can also help you determine the next possible FRU to be replaced when servicing a computer.

If the symptom is not listed, see “Undetermined Problems” on page 92.

The following lists the error messages that the BIOS displays on the screen and the error symptoms classified by function.

**NOTE:** Most of the error messages occur during POST. Some of them display information about a hardware device, e.g., the amount of memory installed. Others may indicate a problem with a device, such as the way it has been configured.

**NOTE:** If the system fails after you make changes in the BIOS Setup Utility menus, reset the computer, enter Setup and install Setup defaults or correct the error.

# Index of Error Messages

## Error Code List

Error Codes	Error Messages
006	Equipment Configuration Error Causes: 1. CPU BIOS Update Code Mismatch 2. IDE Primary Channel Master Drive Error (The causes will be shown before "Equipment Configuration Error")
010	Memory Error at xxxx:xxxx:xxxxh (R:xxxxh, W:xxxxh)
070	Real Time Clock Error
071	CMOS Battery Bad
072	CMOS Checksum Error
110	System disabled. Incorrect password is specified.
<No error code>	Battery critical LOW In this situation BIOS will issue 4 short beeps then shut down system, no message will show.
<No error code>	Thermal critical High In this situation BIOS will shut down system, not show message.

## Error Message List

Error Messages	FRU/Action in Sequence
Failure Fixed Disk	Reconnect hard disk drive connector. "Load Default Settings" in BIOS Setup Utility. Hard disk drive System board
Stuck Key	see "Keyboard or Auxiliary Input Device Check" on page 76.
Keyboard error	see "Keyboard or Auxiliary Input Device Check" on page 76.
Keyboard Controller Failed	see "Keyboard or Auxiliary Input Device Check" on page 76.
Keyboard locked - Unlock key switch	Unlock external keyboard
Monitor type does not match CMOS - Run Setup	Run "Load Default Settings" in BIOS Setup Utility.
Shadow RAM Failed at offset: nnnn	BIOS ROM System board
System RAM Failed at offset: nnnn	DIMM System board
Extended RAM Failed at offset: nnnn	DIMM System board
System battery is dead - Replace and run Setup	Replace RTC battery and Run BIOS Setup Utility to reconfigure system time, then reboot system.
System CMOS checksum bad - Default configuration used	RTC battery Run BIOS Setup Utility to reconfigure system time, then reboot system.
System timer error	RTC battery Run BIOS Setup Utility to reconfigure system time, then reboot system. System board

## Error Message List

Error Messages	FRU/Action in Sequence
Real time clock error	RTC battery Run BIOS Setup Utility to reconfigure system time, then reboot system. System board
Previous boot incomplete - Default configuration used	Run "Load Default Settings" in BIOS Setup Utility. RTC battery System board
Memory size found by POST differed from CMOS	Run "Load Default Settings" in BIOS Setup Utility. DIMM System board
Diskette drive A error	Check the drive is defined with the proper diskette type in BIOS Setup Utility See "External Diskette Drive Check" on page 76.
Incorrect Drive A type - run SETUP	Check the drive is defined with the proper diskette type in BIOS Setup Utility
System cache error - Cache disabled	System board
CPU ID:	System board
DMA Test Failed	DIMM System board
Software NMI Failed	DIMM System board
Fail-Safe Timer NMI Failed	DIMM System board
Device Address Conflict	Run "Load Default Settings" in BIOS Setup Utility. RTC battery System board
Allocation Error for device	Run "Load Default Settings" in BIOS Setup Utility. RTC battery System board
Failing Bits: nnnn	DIMM BIOS ROM System board
Fixed Disk n	None
Invalid System Configuration Data	BIOS ROM System board
I/O device IRQ conflict	Run "Load Default Settings" in BIOS Setup Utility. RTC battery System board
Operating system not found	Enter Setup and see if fixed disk and drive A: are properly identified. Diskette drive Hard disk drive System board



## Error Message List

No beep Error Messages	FRU/Action in Sequence
No beep, power-on indicator turns off and LCD is blank.	Power source (battery pack and power adapter). See "Power System Check" on page 77.. Ensure every connector is connected tightly and correctly. Reconnect the DIMM. LED board. System board.
No beep, power-on indicator turns on and LCD is blank.	Power source (battery pack and power adapter). See "Power System Check" on page 77.. Reconnect the LCD connector Hard disk drive LCD inverter ID LCD cable LCD Inverter LCD System board
No beep, power-on indicator turns on and LCD is blank. But you can see POST on an external CRT.	Reconnect the LCD connectors. LCD inverter ID LCD cable LCD inverter LCD System board
No beep, power-on indicator turns on and a blinking cursor shown on LCD during POST.	Ensure every connector is connected tightly and correctly. System board
No beep during POST but system runs correctly.	Speaker System board

# Phoenix BIOS Beep Codes

Code	Beeps	POST Routine Description
02h		Verify Real Mode
03h		Disable Non-Maskable Interrupt (NMI)
04h		Get CPU type
06h		Initialize system hardware
08h		Initialize chipset with initial POST values
09h		Set IN POST flag
0Ah		Initialize CPU registers
0Bh		Enable CPU cache
0Ch		Initialize caches to initial POST values
0Eh		Initialize I/O component
0Fh		Initialize the local bus IDE
10h		Initialize Power Management
11h		Load alternate registers with initial POST values
12h		Restore CPU control word during warm boot
13h		Initialize PCI Bus Mastering devices
14h		Initialize keyboard controller
16h	1-2-2-3	BIOS ROM checksum
17h		Initialize cache before memory autosize
18h		8254 timer initialization
1Ah		8237 DMA controller initialization
1Ch		Reset Programmable Interrupt Controller
20h	1-3-1-1	Test DRAM refresh
22h	1-3-1-3	Test 8742 Keyboard Controller
24h		Set ES segment register to 4 GB
26h		Enable A20 line
28h		Autosize DRAM
29h		Initialize POST Memory Manager
2Ah		Clear 215 KB base RAM
2Ch	1-3-4-1	RAM failure on address line xxxx
2Eh	1-3-4-3	RAM failure on data bits xxxx of low byte of memory bus
2Fh		Enable cache before system BIOS shadow
30h	1-4-1-1	RAM failure on data bits xxxx of high byte of memory bus
32h		Test CPU bus-clock frequency
33h		Initialize Phoenix Dispatch Manager
36h		Warm start shut down
38h		Shadow system BIOS ROM
3Ah		Autosize cache
3Ch		Advanced configuration of chipset registers
3Dh		Load alternate registers with CMOS values
42h		Initialize interrupt vectors
45h		POST device initialization

Code	Beeps	POST Routine Description
46h	2-1-2-3	Check ROM copyright notice
48h		Check video configuration against CMOS
49h		Initialize PCI bus and devices
4Ah		Initialize all video adapters in system
4Bh		QuietBoot start (optional)
4Ch		Shadow video BIOS ROM
4Eh		Display BIOS copyright notice
50h		Display CPU type and speed
51h		Initialize EISA board
52h		Test keyboard
54h		Set key click if enabled
58h	2-2-3-1	Test for unexpected interrupts
59h		Initialize POST display service
5Ah		Display prompt "Press F2 to enter SETUP"
5Bh		Disable CPU cache
5Ch		Test RAM between 512 and 640 KB
60h		Test extended memory
62h		Test extended memory address lines
64h		Jump to User Patch1
66h		Configure advanced cache registers
67h		Initialize Multi Processor APIC
68h		Enable external and CPU caches
69h		Setup System Management Mode (SMM) area
6Ah		Display external L2 cache size
6Bh		Load custom defaults (optional)
6Ch		Display shadow-area message
6Eh		Display possible high address for UMB recovery
70h		Display error messages
72h		Check for configuration errors
76h		Check for keyboard errors
7Ch		Set up hardware interrupt vectors
7Eh		Initialize coprocessor if present
80h		Disable onboard Super I/O ports and IRQs
81h		Late POST device initialization
82h		Detect and install external RS232 ports
83h		Configure non-MCD IDE controllers
84h		Detect and install external parallel ports
85h		Initialize PC-compatible PnP ISA devices
86h		Re-initialize onboard I/O ports
87h		Configure Motherboard Configurable Devices (optional)
88h		Initialize BIOS Area
89h		Enable Non-Maskable Interrupts (NMIs)
8Ah		Initialize Extended BIOS Data Area
8Bh		Test and initialize PS/2 mouse

Code	Beeps	POST Routine Description
8Ch		Initialize floppy controller
8Fh		Determine number of ATA drives (optional)
90h		Initialize hard-disk controllers
91h		Initialize local-bus hard-disk controllers
92h		Jump to UserPatch2
93h		Build MPTABLE for multi-processor boards
95h		Install CD ROM for boot
96h		Clear huge ES segment register
97h		Fixup Multi Processor table
98h	1-2	Search for option ROMs. One long, two short beeps on checksum failure.
99h		Check for SMART drive (optional)
9Ah		Shadow option ROMs
9Ch		Set up Power Management
9Dh		Initialize security engine (optional)
9Eh		Enable hardware interrupts
9Fh		Determine number of ATA and SCSI drives
A0h		Set time of day
A2h		Check key lock
A4h		Initialize Typematic rate
A8h		Erase F2 prompt
AAh		Scan for F2 key stroke
ACh		Enter SETUP
A Eh		Clear Boot flag
B0h		Check for errors
B2h		POST done- prepare to boot operating system
B4h	1	One short beep before boot
B5h		Terminate QuietBoot (optional)
B6h		Check password (optional)
B9h		Prepare Boot
BAh		Initialize DMI parameters
BBh		Initialize PnP Option ROMs
BCh		Clear parity checkers
BDh		Display MultiBoot menu
BEh		Clear screen (optional)
BFh		Check virus and backup reminders
C0h		Try to boot with INT 19
C1h		Initialize POST Error Manager (PEM)
C2h		Initialize error logging
C3h		Initialize error display function
C4h		Initialize system error handler
C5h		PnPnd dual CMOS (optional)
C6h		Initialize notebook docking (optional)
C7h		Initialize notebook docking late
C8h		Force check (optional)
C9h		Extended checksum (optional)

Code	Beeps	POST Routine Description
D2h		Unknown interrupt

Code	Beeps	POST Routine Description
E0h		Initialize the chipset
E1h		Initialize the bridge
E2h		Initialize the CPU
E3h		Initialize the system timer
E4h		Initialize system I/O
E5h		Check force recovery boot
E6h		Checksum BIOS ROM
E7h		Go to BIOS
E8h		Set Huge Segment
E9h		Initialize Multi Processor
EAh		Initialize OEM special code
EBh		Initialize PIC and DMA
ECh		Initialize Memory type
EDh		Initialize Memory size
EEh		Shadow Boot Block
EFh		System memory test
F0h		Initialize interrupt vectors
F1h		Initialize Run Time Clock
F2h		Initialize video
F3h		Initialize System Management Mode
F4h	1	Output one beep before boot
F5h		Boot to Mini DOS
F6h		Clear Huge Segment
F7h		Boot to Full DOS

# Index of Symptom-to-FRU Error Message

## LCD-Related Symptoms

Symptom / Error	Action in Sequence
LCD backlight doesn't work LCD is too dark LCD brightness cannot be adjusted LCD contrast cannot be adjusted	Enter BIOS Utility to execute "Load Setup Default Settings", then reboot system. Reconnect the LCD connectors. Keyboard (if contrast and brightness function key doesn't work). LCD inverter ID LCD cable LCD inverter LCD System board
Unreadable LCD screen Missing pels in characters Abnormal screen Wrong color displayed	Reconnect the LCD connector LCD inverter ID LCD cable LCD inverter LCD System board
LCD has extra horizontal or vertical lines displayed.	LCD inverter ID LCD inverter LCD cable LCD System board

## Indicator-Related Symptoms

Symptom / Error	Action in Sequence
Indicator incorrectly remains off or on, but system runs correctly	Reconnect the inverter board Inverter board System board

## Power-Related Symptoms

Symptom / Error	Action in Sequence
Power shuts down during operation	Power source (battery pack and power adapter). See "Power System Check" on page 77. Battery pack Power adapter Hard drive & battery connection board System board
The system doesn't power-on.	Power source (battery pack and power adapter). See "Power System Check" on page 77. Battery pack Power adapter Hard drive & battery connection board System board
The system doesn't power-off.	Power source (battery pack and power adapter). See "Power System Check" on page 77. Hold and press the power switch for more than 4 seconds. System board

### Power-Related Symptoms

Symptom / Error	Action in Sequence
Battery can't be charged	See "Check the Battery Pack" on page 79. Battery pack System board

### PCMCIA-Related Symptoms

Symptom / Error	Action in Sequence
System cannot detect the PC Card (PCMCIA)	PCMCIA slot assembly System board
PCMCIA slot pin is damaged.	PCMCIA slot assembly

### Memory-Related Symptoms

Symptom / Error	Action in Sequence
Memory count (size) appears different from actual size.	Enter BIOS Setup Utility to execute "Load Default Settings, then reboot system. DIMM System board

### Speaker-Related Symptoms

Symptom / Error	Action in Sequence
In Windows, multimedia programs, no sound comes from the computer.	Audio driver Speaker System board
Internal speakers make noise or emit no sound.	Speaker System board

### Power Management-Related Symptoms

Symptom / Error	Action in Sequence
The system will not enter hibernation	See "Save to Disk (S4)" on page 45. Keyboard (if control is from the keyboard) Hard disk drive System board
The system doesn't enter hibernation mode and four short beeps every minute.	Press Fn+ <b>0</b> and see if the computer enters hibernation mode. Touchpad Keyboard Hard disk connection board Hard disk drive System board
The system doesn't enter standby mode after closing the LCD	See "Save to Disk (S4)" on page 45. LCD cover switch System board
The system doesn't resume from hibernation mode.	See "Save to Disk (S4)" on page 45. Hard disk connection board Hard disk drive System board
The system doesn't resume from standby mode after opening the LCD.	See "Save to Disk (S4)" on page 45. LCD cover switch System board

### Power Management-Related Symptoms

Symptom / Error	Action in Sequence
Battery fuel gauge in Windows doesn't go higher than 90%.	Remove battery pack and let it cool for 2 hours. Refresh battery (continue use battery until power off, then charge battery). Battery pack System board
System hangs intermittently.	Reconnect hard disk/CD-ROM drives. Hard disk connection board System board

### Peripheral-Related Symptoms

Symptom / Error	Action in Sequence
System configuration does not match the installed devices.	Enter BIOS Setup Utility to execute "Load Default Settings", then reboot system. Reconnect hard disk/CD-ROM/diskette drives.
External display does not work correctly.	Press Fn+F5, LCD/CRT/Both display switching System board
USB does not work correctly	System board
Print problems.	Ensure the "Parallel Port" in the "Onboard Devices Configuration" of BIOS Setup Utility is set to Enabled. Onboard Devices Configuration Run printer self-test. Printer driver Printer cable Printer System Board
Serial or parallel port device problems.	Ensure the "Serial Port" in the Devices Configuration" of BIOS Setup Utility is set to Enabled. Device driver Device cable Device System board

### Keyboard/Touchpad-Related Symptoms

Symptom / Error	Action in Sequence
Keyboard (one or more keys) does not work.	Reconnect the keyboard cable. Keyboard System board
Touchpad does not work.	Reconnect touchpad cable. Touchpad board System board

### Modem-Related Symptoms

Symptom / Error	Action in Sequence
Internal modem does not work correctly.	Modem phone port modem combo board System board

**NOTE:** If you cannot find a symptom or an error in this list and the problem remains, see "Undetermined Problems" on page 92.



---

# Intermittent Problems

Intermittent system hang problems can be caused by a variety of reasons that have nothing to do with a hardware defect, such as: cosmic radiation, electrostatic discharge, or software errors. FRU replacement should be considered only when a recurring problem exists.

When analyzing an intermittent problem, do the following:

1. Run the advanced diagnostic test for the system board in loop mode at least 10 times.
2. If no error is detected, do not replace any FRU.
3. If any error is detected, replace the FRU. Rerun the test to verify that there are no more errors.

---

# Undetermined Problems

The diagnostic problems does not identify which adapter or device failed, which installed devices are incorrect, whether a short circuit is suspected, or whether the system is inoperative.

Follow these procedures to isolate the failing FRU (do not isolate non-defective FRU).

**NOTE:** Verify that all attached devices are supported by the computer.

**NOTE:** Verify that the power supply being used at the time of the failure is operating correctly. (See "Power System Check" on page 77.):

1. Power-off the computer.
2. Visually check them for damage. If any problems are found, replace the FRU.
3. Remove or disconnect all of the following devices:
  - q Non-Acer devices
  - q Printer, mouse, and other external devices
  - q Battery pack
  - q Hard disk drive
  - q DIMM
  - q CD-ROM/Diskette drive Module
  - q PC Cards
4. Power-on the computer.
5. Determine if the problem has changed.
6. If the problem does not recur, reconnect the removed devices one at a time until you find the failing FRU.
7. If the problem remains, replace the following FRU one at a time. Do not replace a non-defective FRU:
  - q System board
  - q LCD assembly

# Jumper and Connector Locations

## Top View

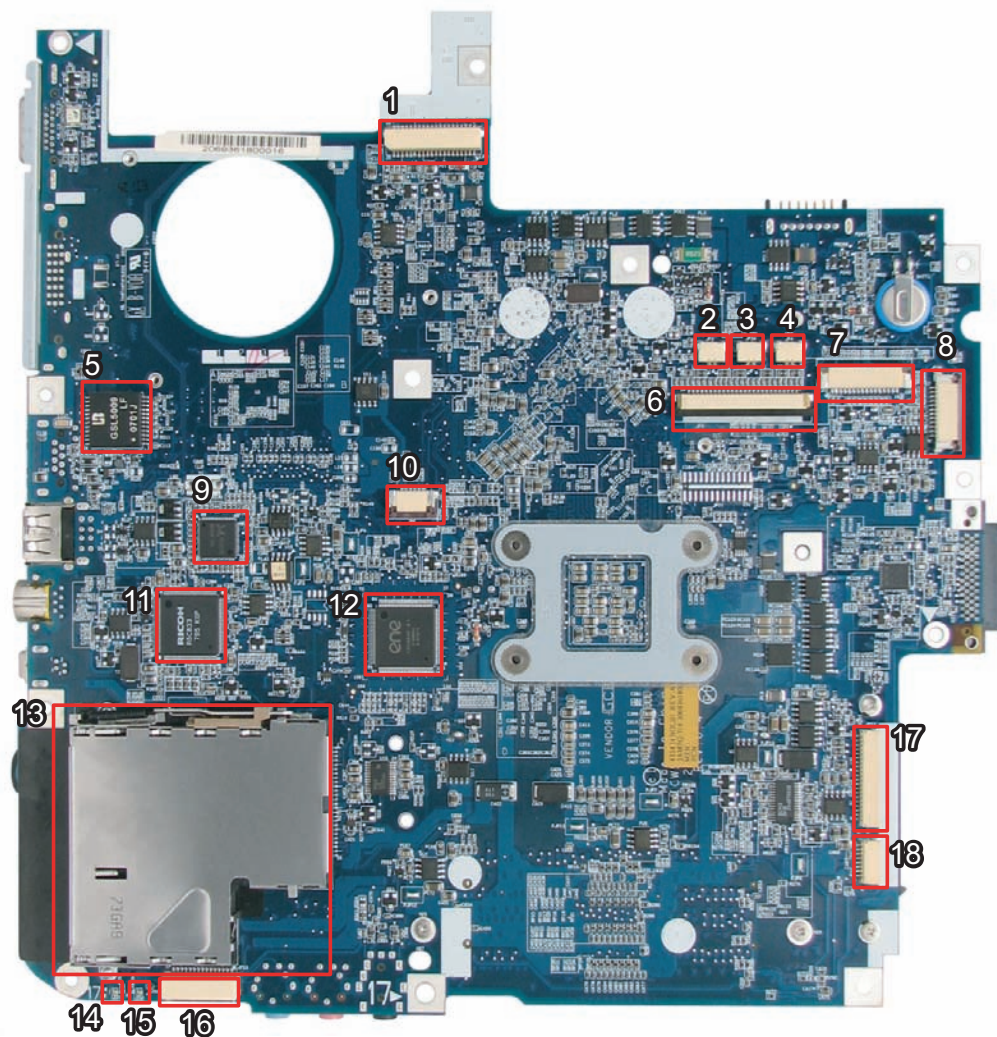

1	JP1	LVDS Connector	10	JP6	Touchpad Connector
2	JP3	Speaker (Left) Connector	11	U14	R5C833 Chip
3	JP34	Speaker (Right) Connector	12	U15	Keyboard Controller
4	JP4	Microphone Connector	13	JP9	PCI Express Card Socket
5	T1		14	LED1	Power/Suspend LED
6	JP5	Keyboard Connector	15	LED2	Battery Charge/Discharge LED
7	JP2	Button Board Connector	16	JP13	Mainboard to Audio Board Connector
8	JP36	LED Board Connector	17	JP11	Mainboard to USB & TV Board Connector
9		PHY RTL&11B Chip	18	JP12	Bluetooth Module Connector

## Bottom View

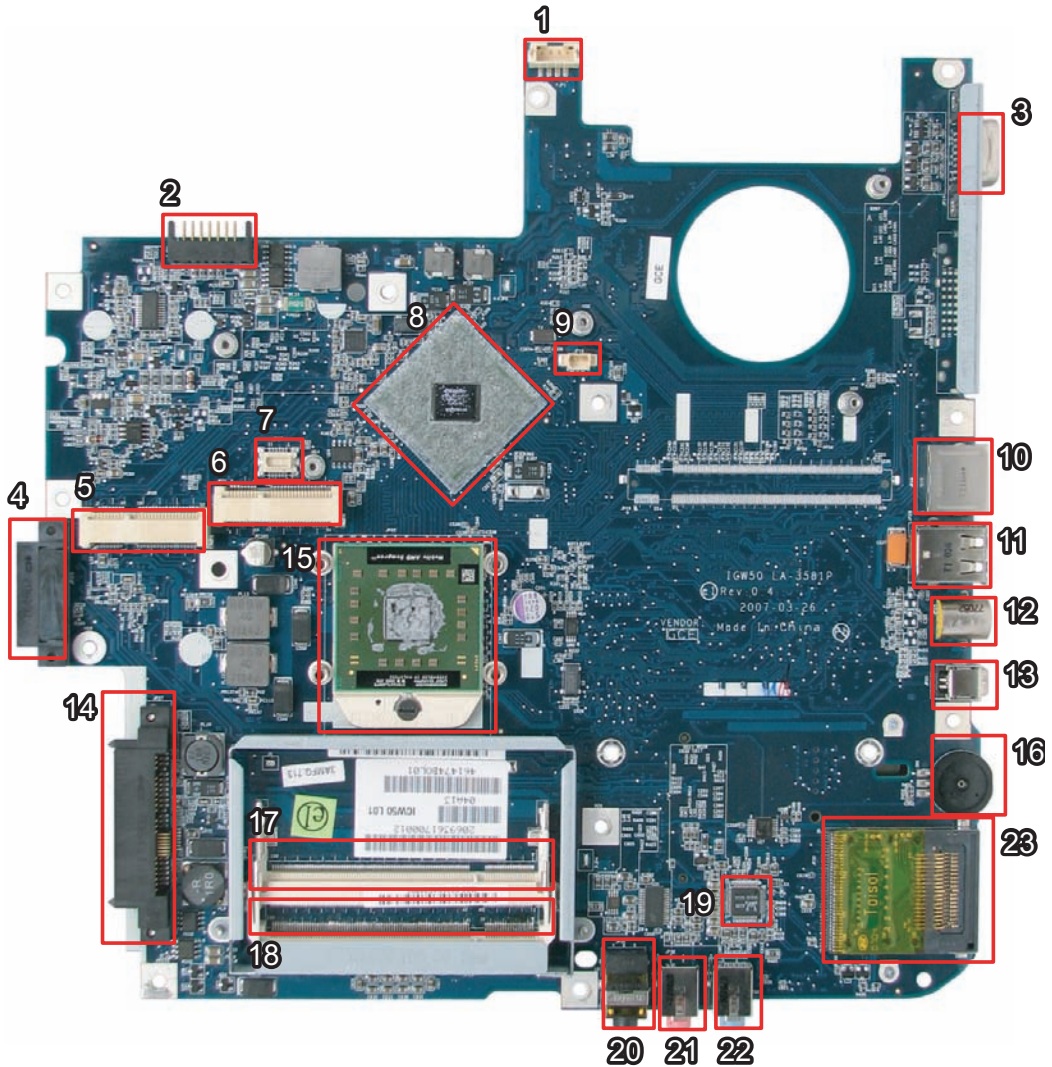

1	PJP1	DC-in Power Jack	13	JP26	IEEE1394 Connector
2	PJP2	Battery Connector	14	JP27	SATA HDD Connector
3	JP14	D-Sub CRT Connector	15	JP22	CPU Socket
4	JP25	ODD Connector	16	SW1	Volume Control
5	JP20	Mini Card (TV-Tuner) Connector	17	JP28	DDRII Memory Socket
6	JP20	Mini Card (WLAN) Connector	18	JP29	DDRII Memory Socket
7	JP21	Mini Card (TV-Tuner) Socket	19	U29	Audio Codec Controller
8	U23	North Bridge	20	JP31	Line-Out/Headphone/SPDIF Jackt
9	JP16	Internal Fan Connector	21	JP32	Mic-in Jack
10	JP18	RJ45 (LAN) Connector	22	JP33	Line-in Jack
11	JP23	USB (Dual) Connectors	23	JP33	Memory Card Reader
12	JP24	TV-out Connector			

## FRU (Field Replaceable Unit) List

---

This chapter gives you the FRU (Field Replaceable Unit) listing in global configurations of Aspire 7520/7220. Refer to this chapter whenever ordering for parts to repair or for RMA (Return Merchandise Authorization).

Please note that WHEN ORDERING FRU PARTS, you should check the most up-to-date information available on your regional web or channel. For whatever reasons a part number change is made, it will not be noted on the printed Service Guide. For ACER AUTHORIZED SERVICE PROVIDERS, your Acer office may have a DIFFERENT part number code from those given in the FRU list of this printed Service Guide. You MUST use the local FRU list provided by your regional Acer office to order FRU parts for repair and service of customer machines.

**NOTE:** To scrap or to return the defective parts, you should follow the local government ordinance or regulations on how to dispose it properly, or follow the rules set by your regional Acer office on how to return it.

## Aspire 7520/7220 FRU List

Category	No.	Part Name and Description	Acer Part No.
<b>ADAPTER</b>			
		ADAPTER 65W 3PIN DELTA SADP-65KB DBFF	AP.06501.009
		ADAPTER 65W 3PIN DELTA SADP-65KB DFA	AP.06501.013
		ADAPTER 65W 3PIN LITEON PA-1650-02LR	AP.06503.012
		ADAPTER 65W 3PIN LITEON PA-1650-02AC	AP.06503.016
		ADAPTER 90W 3PIN LITEON PA-1900-24AR	AP.09003.011
		ADAPTER 90W 3PIN LITEON PA-1900-04 LR	AP.09003.006
		ADAPTER 90W 3PIN LI SHIN SLS0202C19A20LF 90W	AP.09001.003
		ADAPTER 90W 3PIN DELTA ADP-90SB BBEA 90W 3P	AP.09001.013
<b>BATTERY</b>			
		BATTERY LI-ION 6CELLS 4KMAH PANASONIC PA 3S2P 4.0AH 7 01K 0FA	BT.00605.015
		BATTERY LI-ION 6CELLS 4KMAH SANYO SA 3S2P 4AH 7 01K 0FA	BT.00603.033
		BATTERY LI-ION 6CELLS 4KMAH SIMPLO SP PA 3S2P 4.0AH 7 01K 0FA	BT.00607.010
		BATTERY LI-ION 6CELLS 4KMAH SONY SY 3S2P 4.0AH 7 01K 0FA	BT.00604.018
		BATTERY LI-ION 8CELLS 4.8MAH PANASONIC PA 4S2P 4.8AH 7 01K 0FA	BT.00805.011
		BATTERY LI-ION 8CELLS 4.8MAH SANYO SA 4S2P 4.8AH 7 01K 0FA	BT.00803.024
		BATTERY LI-ION 8CELLS 4.8MAH SIMPLO SP PA 4S2P 4.8AH 7 01K 0FA	BT.00807.014
		BATTERY LI-ION 8CELLS 4.8MAH SONY SY 4S2P 4.8AH 7 01K 0FA	BT.00804.020
<b>BOARD</b>			
		MODEM BOARD	FX.22500.009
		BLUETOOTH BOARD	54.AJ802.001
		MINI WLAN/B 802.11 B/G FOXCONN Atheros	NI.23600.007
		MINI WLAN/B 802.11 B/G FOXCONN BROADCOM	NI.23600.011
		MINI WLAN/B 802.11 A/G/N BCM4321 Foxconn (Broadcom)	TBD

Category	No.	Part Name and Description	Acer Part No.
		TV TUNER AVERMEDIA 01K A310 DVB-T	TU.23100.010
		BUTTON BOARD W/CABLE 17	55.AK602.001
		HDD BOARD 17	55.AK602.002
		LED BOARD W/CABLE 17	55.AK602.003
		ODD BOARD 17	55.AK602.004
		AUDIO BOARD 17	55.AK602.005
		RF BOARD	55.AJ802.005
		USB BOARD FOR TV	55.AJ802.003
		USB BOARD FOR W/O TV	55.AJ802.004
		VGA BOARD-512MB NB8P-SE	55.ALX02.001
		VGA BOARD-128MB NB8M-SE	VG.8MS02.001
		VGA BOARD-256MB NB8M-SE	55.AK602.006
<b>CABLE</b>			
		RJ11 CABLE 17"	50.AK602.001
		T/P FFC 17"	50.AK602.002
		BLUETOOTH CABLE 17	50.AK602.003
		USB CABLE 17	50.AK602.005





Category	No.	Part Name and Description	Acer Part No.
		RF CABLE 17	50.AK602.001
		PAL TO NTSC CONNECTOR	20.ABD02.001
		SMB JACK	50.AJV02.001
		DVB-T ANT	50.ABD02.003
		DC-IN CABLE (65W) UMA	50.AHE02.009
		DC-IN CABLE (90W) UMA/DIS	50.AJE02.001
		POWER CORD US 3 PIN	27.TAVV5.001
		POWER CORD EU 3 PIN	27.TAVV5.002
		POWER CORD AUS 3 PIN	27.TAVV5.003
		POWER CORD UK 3 PIN	27.TAVV5.004
		POWER CORD CHINA 3 PIN	27.TAVV5.005
		POWER CORD SWISS 3 PIN	27.TAVV5.006
		POWER CORD ITALIAN 3 PIN	27.TAVV5.007
		POWER CORD DENMARK 3 PIN	27.TAVV5.008
		POWER CORD JP 3 PIN	27.TAVV5.009
		POWER CORD SOUTH AFRICA 3 PIN	27.TAVV5.010
		POWER CORD KOREA 3 PIN	27.TAVV5.011
		POWER CORD ISRAEL 3 PIN	27.TAVV5.012
		POWER CORD INDIA 3 PIN	27.TAVV5.013
		POWER CORD TWN 3 PIN	27.TAVV5.014
CASE/COVER/BRACKET ASSEMBLY			
		MIDDLE COVER 17	42.AK602.001
		UPPER CASE ASSY 17 W/TP TP BRACKET FFC	60.AK602.001
		LOWER CASE ASSY DIS W/O TV-17	60.AK602.002
		LOWER CASE ASSY DIS W/TV-17	60.AK602.003
		LOWER CASE ASSY UMA W/O TV-17	60.AKG02.001
		LOWER CASE ASSY UMA W/TV-17	60.AKG02.002
		THERMAL DOOR 17 DIS	42.AK602.002
		THERMAL DOOR 17 UMA	42.AKG02.001
CPU/PROCESSOR			









Category	No.	Part Name and Description	Acer Part No.
		CPU AMD SEMPRON 512K 1.8G SMS3500HAX4CM	KC.S3502.25F
		CPU AMD Turion 64 512K+512K 1.6G TMDTL52HAX5CT	KC.TTL02.520
		CPU AMD Turion 64 512K+512K 1.8G TMDTL56HAX5CT	KC.TTL02.560
		CPU AMD Turion 64 512K+512K 2.0G TMDTL60HAX5CT	KC.TTL02.600
		CPU AMD Turion 64 512K+512K 2.0G TMDTL60HAX5DC	KC.TTL02.60G
		CPU AMD Turion 64 512K+512K 2.1G TMDTL62HAX5DM (TL62 Rev G2)	KC.TTL02.62M
		CPU AMD Turion 64 512K+512K 1.8G TMDTL56HAX5DC	KC.TTL02.56G
		CPU AMD Turion 64 1.9G TMDTL58HAX5DC	KC.TTL02.58G
		CPU AMD Turion 64 1.9G TMDTL58HAX5DM (TL58 Rev G2)	KC.TTL02.58M
		CPU AMD Turion 64 2.2G TMDTL64HAX5CT	KC.TTL02.640
		CPU AMD Turion 64 2.2G TMDTL64HAX5DC	KC.TTL02.64G
		CPU AMD Turion 64 2.3G TMDTL66HAX5DC	KC.TTL02.66G
		CPU AMD Turion 64 2.2G TMDMK38HAX4CM	KC.TMK02.380
		CPU AMD SEMPRON 2.2G SMD3800HAX3CM	KC.S3802.25F
		CPU AMD SEMPRON 2.0G SMS3600HAX3CM	KC.S3602.25F
		CPU AMD SEMPRON 2.0G SMS3600HAX3DN (Rev G2)	KC.S3602.25N
		CPU AMD SEMPRON 2.2G SMD3800HAX3DN (Rev G2)	KC.S3802.25N
		CPU AMD Turion 64 2.0G TMDMK36HAX4CM	KC.TMK02.360
		CPU AMD Turion 64 1.7G ATHLON AMDTK53HAX4DC (Athlon64X2 TK53 ouPGA 1.7G 2x256K 800 638 31W G-1)	KC.ATK02.530
		CPU AMD Turion 64 1.8G AMDTK55HAX4DC (TK55 Rev G1)	KC.ATK02.550
<b>COMBO MODULE</b>			
		DVD/CDRW 24X COMBO MODULE	6M.AK602.001
		DVD/CDRW COMBO DRIVE SONY CRX880A VISTA	KO.0240E.005
		DVD/CDRW COMBO DRIVE PANASONIC UJDA-780 GB LF	KO.02407.028
		DVD/CDRW COMBO DRIVE HLDS GCC-T10N VISTA	KO.0240D.005

Category	No.	Part Name and Description	Acer Part No.
		ODD BEZEL-COMBO	42.AJ802.004
		ODD BRACKET 17	33.AK602.001
DVD-RW DRIVE			
		DVD SUPER MULTI MODULE TRAY IN	6M.AK602.002
		DVD SUPER MULTI DRIVE PIONEER FW:1.00 Tray DL 8X DVR-K17RS LF PATA GBASE	KU.00805.038
		DVD SUPER MULTI DRIVE PIONEER FW:1.01 Tray DL 8X DVR-K17RS LF W/ O bezel PATA GBASE	KU.00805.042
		DVD SUPER MULTI DRIVE HLDS 12.7mm Tray DL 8X GSA-T20N LF	KU.0080D.027
		DVD SUPER MULTI DRIVE PHILIPS 12.7mm Tray DL 8X PHILIPS DS-8A1P , LF , Gbase	KU.00809.010
		DVD SUPER MULTI DRIVE SONY 12.7mm Tray DL 8X AD-7530A LF W/O bezel EY01 PATA	KU.0080E.002
		DVD SUPER MULTI DRIVE SONY 12.7mm Tray DL 8X AD-7560A	KU.0080E.005
		ODD BEZEL-SUPER MULTI	42.AJ802.005
		ODD BRACKET 17	33.AK602.001
		HD-DVD MODULE	N/A
		HD-DVD DRIVE TOSHIBA 1X HD DVD ROM TOSHIBA TS-L802A,LF ,GBASE	KV.00101.002
		ODD BEZEL-HD DVD	42.AJE02.002
		ODD BRACKET 17	33.AK602.001
HDD/HARD DISK DRIVE			
		HDD SATA 80G 5400 RPM HGST SATA HTS541680J9SA00 SURUGA-B LF F/ W: C70P	KH.08007.021
		HDD SATA 80G 5400 RPM SEAGATE ST980811AS SATA 8MB LF 3.ALD	KH.08001.030
		HDD SATA 80G 5400 RPM TOSHIBA MK8037GSX Gemini BS SATA LF F/ W:DL230J	KH.08004.010
		HDD SATA 80G 5400 RPM WD WD800BEVS-22RST0 ML80 SATA LF F/ W:04.01G04	KH.08008.033

Category	No.	Part Name and Description	Acer Part No.
		HDD SATA 120G 5400 RPM HGST SATA HTS541612J9SA00 SURUGA-B LF F/W: C70P	KH.12007.010
		HDD SATA 120G 5400 RPM SEAGATE ST9120822AS Venus SATA LF 3.ALD	KH.12001.031
		HDD SATA 120G 5400RPM TOSHIBA MK1237GSX Gemini BS SATA LF F/ W:DL130J	KH.12004.006
		HDD SATA 120G 5400RPM WD WD1200BEVS-22RST0 ML80 SATA LF F/W:04.01G04	KH.12008.018
		HDD SATA 160G 5400RPM HGST HTS541616J9SA00 SURUGA-B LF F/ W: C70P	KH.16007.011
		HDD SATA 160G 5400RPM SEAGATE ST9160821AS SATA 8MB LF 3.ALD	KH.16001.026
		HDD SATA 160G 5400RPM TOSHIBA MK1637GSX Gemini BS SATA LF F/W: DL030J	KH.16004.001
		HDD SATA 160G 5400RPM WD WD1600BEVS-22RST0 ML80 SATA LF F/W:04.01G04	KH.16008.019
		HDD SATA 200G 4200RPM TOSHIBA MK2035GSS Gemini SATA LF F/ W:DK022A	KH.20004.001
		HDD DOOR 17	42.AK602.003
		HDD BRACKET 17	33.AK602.002
<b>KEYBOARD</b>			
		KEYBOARD 17KB-FV2 105KS WHITE US INTERNATIONAL	KB.INT00.138
		KEYBOARD 17KB-FV2 105KS WHITE ARABIC/ENGLISH	KB.INT00.170
		KEYBOARD 17KB-FV2 106KS WHITE BELGIUM	KB.INT00.169
		KEYBOARD 17KB-FV2 106KS WHITE BRAZILIAN PORTUGUESE	KB.INT00.168
		KEYBOARD 17KB-FV2 106KS WHITE CANADIAN FRENCH	KB.INT00.167
		KEYBOARD 17KB-FV2 105KS WHITE TRADITIONAL CHINESE	KB.INT00.166
		KEYBOARD 17KB-FV2 106KS WHITE DANISH	KB.INT00.164
		KEYBOARD 17KB-FV2 106KS WHITE DUTCH	KB.INT00.163
		KEYBOARD 17KB-FV2 106KS WHITE FRENCH	KB.INT00.161
		KEYBOARD 17KB-FV2 106KS WHITE GERMAN	KB.INT00.160

Category	No.	Part Name and Description	Acer Part No.
		KEYBOARD 17KB-FV2 105KS WHITE GREEK	KB.INT00.159
		KEYBOARD 17KB-FV2 106KS WHITE HUNGARIAN	KB.INT00.158
		KEYBOARD 17KB-FV2 106KS WHITE ITALIAN	KB.INT00.155
		KEYBOARD 17KB-FV2 105KS WHITE KOREAN	KB.INT00.154
		KEYBOARD 17KB-FV2 106KS WHITE NORWEGIAN	KB.INT00.152
		KEYBOARD 17KB-FV2 106KS WHITE PORTUGUESE	KB.INT00.150
		KEYBOARD 17KB-FV2 105KS WHITE RUSSIAN	KB.INT00.149
		KEYBOARD 17KB-FV2 106KS WHITE SLO/CRO	KB.INT00.146
		KEYBOARD 17KB-FV2 106KS WHITE SLOVAK	KB.INT00.147
		KEYBOARD 17KB-FV2 106KS WHITE SPANISH	KB.INT00.145
		KEYBOARD 17KB-FV2 106KS WHITE SWEDISH	KB.INT00.144
		KEYBOARD 17KB-FV2 106KS WHITE SWISS/G	KB.INT00.143
		KEYBOARD 17KB-FV2 105KS WHITE THAILAND	KB.INT00.142
		KEYBOARD 17KB-FV2 106KS WHITE TURKISH	KB.INT00.141
		KEYBOARD 17KB-FV2 106KS WHITE UK	KB.INT00.140
		KEYBOARD 17KB-FV2 105KS WHITE US INTERNATIONAL HEBREW	KB.INT00.139
	KEYBOARD 17 JP	TBD	
<b>LCD</b>			
		ASSY LCD MODULE 17 WXGA GLARE W/ANTENNA & CCD	6M.AK602.003
		ASSY LCD MODULE 17" WXGA IMR GLARE W/ANTENNA & CCD	6M.AM402.001
		ASSY LCD MODULE 17 IN. WXGA GLARE W/ANTENNA W/O CCD	6M.AKN02.001
		LCD 17 WXGA GLARE AUO B170PW03 V4 200nits 16ms	LK.17105.005
		LCD 17 WXGA GLARE CMO N170C2-L02 10ms 200nits	LK.1700D.009
		LCD 17 WXGA GLARE LPL LP171WP4-TLB1 16ms 200nits	LK.17008.025
		LCD 17 WXGA GLARE SAMSUNG LTN170X2-L02-H 16ms 200nits PMMA	LK.17006.024
		INVERTER BOARD 17	19.AK602.001

Category	No.	Part Name and Description	Acer Part No.
		LCD WIRESET 17	50.AK602.007
		LCD COVER ASSY 17 LOGO W/MIC W/ ANTENNA	60.AK602.004
		LCD COVER ASSY 17 IMR LOGO W/ MIC W/ANTENNA	60.AM402.001
		LCD BEZEL ASSY 17 FOR CCD	60.AK602.005
		LCD BEZEL ASSY 17 WHITE FOR CCD	60.AM402.002
		LCD BRACKET SET R&L-17	33.AK602.003
		CCD MODULE 0.3M	57.AJ802.001
		CCD BRACKET 17	33.AK602.004
		LCD SCREW PAD 17	47.AK602.002
		LCD SIDE RUBBER 17	47.AK602.003
		LCD FRONT RUBBER 17	47.AK602.004
		LCD SCREW PAD WHITE 17	47.AM402.001
		LCD SIDE RUBBER WHITE 17	47.AM402.002
		LCD FRONT RUBBERWHITE 17	47.AM402.003
<b>MAINBOARD</b>			
		MAINBOARB MCP67 UMA 10/100 LAN W/CARD READER_EXPRESS CARD W/O CPU MEMORY	MB.AJ702.001
		MAINBOARB MCP67 UMA W/CARD READER_EXPRESS CARD W/O CPU MEMORY 3rd CUT SSIC GLAN W/ REWORK	MB.AJ702.002
		MAINBOARB MCP67 UMA W/CARD READER_EXPRESS CARD W/O CPU MEMORY 3rd CUT SSIC GLAN NEW PCB	MB.AJ702.003
		MAINBOARB MCP67 DISCRETE 10/100 LAN W/CARD READER_EXPRESS CARD W/O CPU MEMORY	MB.AK302.001
		MAINBOARB MCP67 DISCRETE W/ CARD READER_EXPRESS CARD W/O CPU MEMORY 3rd CUT SSIC GLAN W/ REWORK	MB.AK302.002
		MAINBOARB MCP67 DISCRETE W/ CARD READER_EXPRESS CARD W/O CPU MEMORY 3rd CUT SSIC GLAN NEW PCB	MB.AK302.003

Category	No.	Part Name and Description	Acer Part No.
<b>MEMORY</b>			
		MEMORY 512MB DDRII 667 NANYA NT512T64UH8B0FN-3C	KN.51203.032
		MEMORY 512MB DDRII 667 SAMSUNG M470T6554EZ3-CE6	KN.5120B.023
		MEMORY 512MB DDRII 667 HYNIX HYMP564S64CP6-Y5	KN.5120G.019
		MEMORY 1GB DDRII 667 NANYA NT1GT64U8HB0BN-3C	KN.1GB03.014
		MEMORY 1GB DDRII 667 SAMSUNG M470T2953EZ3-CE6	KN.1GB0B.011
		MEMORY 1GB DDRII 667 HYNIX HYMP512S64CP8-Y5	KN.1GB0G.006
<b>FAN</b>			
		FAN	23.AJ802.001
<b>HEATSINK</b>			
		CPU THERMAL MODULE	60.AJ802.006
		VGA THERMAL(NB8P)-DIS	60.AK602.007
		VGA THERMAL(NB8M)-DIS	60.AK602.008
<b>SPEAKER</b>			
		SPEAKER R&L 17	23.AK602.001
		SUB WOOFER	23.AK602.002
<b>ANTENNAS</b>			
		ANTENNA R 17	50.AK602.008
		ANTENNA L-17	50.AK602.009
		MIC SET-17	23.AK602.003
<b>ACCESSORY</b>			
		REMOTE CONTROLLER EU	LZ.20400.004
		REMOTE CONTROLLER TS	LZ.20400.005
		REMOTE CONTROLLER SC	LZ.20400.006
		REMOTE CONTROLLER EN	LZ.20400.007
<b>MISCELLANEOUS</b>			
		RUBBER FOOT B	47.AK602.005
		RUBBER FOOT C	47.AK602.006
		THERMAL RUBBER FOOT	47.AK602.007

Category	No.	Part Name and Description	Acer Part No.
		THERMAL PAD-MOSFET	47.AJ802.008
		NAME PLATE-AS7220	40.AKN02.001
		NAME PLATE-AS7520	40.AK602.001
SCREW			
		SCREW,M2.5*12 (NL)	86.AHE02.003
		SCREW,M2.5*4	86.AHJ02.001
		SCREW,M2.5*6 (NL)	86.AHE02.002
		SCREW,M2*3 (NL)	86.AHE02.005
		SCREW,M2*2.2	86.AHE02.004
		SCREW,M2*4 (NL)	86.AHJ02.002
		SCREW,M3*4 (NL)	86.AHJ02.003
		SCREW, F 4# 5L K 4.5D ZK NL + CR3+	86.AHJ02.004
		SCREW,M M 2D 3.0L K 8.0D NI +	86.AHJ02.005
		CPU THERMAL SCREW ASSY	86.AHJ02.006
		SCREW,M M 2.0D 3L K 5D NI +	86.AHE02.008

