



IBM Systems - iSeries
Networking
APPC, APPN, and HPR

Version 5 Release 4





IBM Systems - iSeries
Networking
APPC, APPN, and HPR

Version 5 Release 4

Note

Before using this information and the product it supports, be sure to read the information in "Notices" on page 105.

Ninth Edition (February 2006)

This edition applies to version 5, release 4, modification 0 of i5/OS (product number 5722-SS1) and to all subsequent releases and modifications until otherwise indicated in new editions. This version does not run on all reduced instruction set computer (RISC) models nor does it run on CISC models.

© Copyright International Business Machines Corporation 1998, 2006. All rights reserved.

US Government Users Restricted Rights – Use, duplication or disclosure restricted by GSA ADP Schedule Contract with IBM Corp.

Contents

APPC, APPN, and HPR	1		
What's new for V5R4	1		
Printable PDF	2		
Plan your APPN and HPR network.	2		
Select your APPC networking protocol	2		
Design an APPN and HPR network to optimize communications performance.	3		
Configure APPC, APPN, and HPR	4		
Automatic configuration on LANs	4		
Manual configuration for APPN and HPR	7		
Configure Branch Extender support	11		
Connection network support.	11		
Configuration considerations used to optimize error recovery performance	13		
Connect a PC to iSeries using Personal Communications	23		
Configure APPC with VTAM	23		
Examples: APPC, APPN, and HPR configuration	24		
APPN configuration examples	24		
Examples: Configure HPR	79		
Optimize APPN and HPR communication performance	80		
Performance considerations for APPN and HPR	81		
Optimize communications using high-performance routing	82		
APPN virtual controllers and communications performance	83		
			Fine-tune configuration parameters for APPC performance 84
			APPC, APPN, and HPR security 86
			Session-level security for APPN and HPR 87
			Protect your system in an APPN and HPR environment 87
			Troubleshooting APPN and HPR 90
			Solve remote communication problems using STRPASTHR 91
			Solve communication problems using DSPAPPNINF 91
			Solve communication problems using WRKAPPNSTS 92
			Solve communications problems using communications trace 92
			Solve communication problems using session activity 92
			Finding Systems Network Architecture sense codes 92
			APPN error log data 93
			Code license disclaimer information 104
			 Notices 105
			Programming Interface Information 107
			Trademarks 107
			Terms and conditions. 107

APPC, APPN, and HPR

There are so many different networking schemes, possibilities, and protocols, so it might be difficult to decide on the best setup for you and your business.

Systems Network Architecture (SNA) includes the layered logical structure, formats, protocols, and operational sequences that are used for transmitting information units through networks. One example of implementing SNA to connect the i5/OS™ or iSeries™ server with other systems, to connect remote controllers and to maintain a high-level of security on your system, is through the use of APPC, APPN, and HPR.

- | Enterprise Extender is a networking architecture that allows Systems Network Architecture (SNA) applications to run over Internet Protocol (IP) networks using High Performance Routing (HPR). This is the preferred way to run SNA applications over IP networks with communications input/output adapters (IOAs), such as Gigabit Ethernet, since these IOAs do not require an input/output processor (IOP).
- | Gigabit Ethernet adapters do not automatically support SNA traffic. Enterprise Extender (or AnyNet®) is required to allow SNA data to flow over a Gigabit adapter. IBM® recommends that Enterprise Extender be used in place of AnyNet. For more information, see Migration from AnyNet to Enterprise Extender.

If using APPC, APPN, and HPR sounds like a possibility, review the following pages:

What's new for V5R4

Highlights the changes and improvements made to APPC, APPN, and HPR.

Printable PDF

Print this topic to view a hardcopy of APPC, APPN, and HPR.

Planning your APPN and HPR network

Steps you should take before setting up and configuring your APPN and HPR network.

Configuring APPC, APPN, and HPR

Information about automatically or manually setting up your network.

Examples: APPC, APPN, and HPR configuration

Examples of network configurations to help you set up your own network.

Optimizing APPN and HPR communication performance

Ways to achieve optimal performance with your particular communications environment.

APPC, APPN, and HPR security

Information to help keep your APPN environment secure.

Troubleshooting APPN and HPR

Find solutions to communications problems.

- | If you would like more Information about APPC, see APPC Programming. 

- | **Note:** By using the code examples, you agree to the terms of the "Code license disclaimer information" on page 104.

What's new for V5R4

- | Enterprise Extender is a networking architecture that allows Systems Network Architecture (SNA) applications to run over Internet Protocol (IP) networks using High Performance Routing (HPR). This is the preferred way to run SNA applications over IP networks with communications input/output adapters (IOAs), such as Gigabit Ethernet, since these IOAs do not require an input/output processor (IOP).

Communications adapters that do not use an IOP do not support SNA, therefore, Enterprise Extender is required to run SNA over these adapters. IBM recommends that Enterprise Extender be used in place of AnyNet.

Communications trace is improved to capture HPR data running over IP networks, allowing you to troubleshoot Enterprise Extender communications problems.

Printable PDF

To view or download the PDF version, select APPC, APPN, and HPR (about 1270 KB).

Saving PDF files

To save a PDF file on your workstation for viewing or printing:

1. Right-click the PDF file in your browser (right-click the link above).
2. Click the option that saves the PDF locally.
3. Navigate to the directory in which you want to save the PDF file.
4. Click **Save**.

Downloading Adobe Reader

You need Adobe Reader installed on your system to view or print these PDFs. You can download a free copy from the Adobe Web site (www.adobe.com/products/acrobat/readstep.html) .

Plan your APPN and HPR network

After you have decided to set up APPN and HPR for your network, there are a some things you may want to keep in mind before setting up and configuring. For more information, see the following:

- Selecting your APPC networking protocol
This topic gives you some operational characteristics to think about when choosing your protocol.
- Designing an APPN and HPR network
This topic discusses some design theories to consider for optimal communication performance.

Select your APPC networking protocol

When choosing the advanced program-to-program communications (APPC) networking protocol for your business, you should understand some of the operational characteristics for APPN and HPR. These operational characteristics may affect communication performance on your system.

Note: While you can run APPC without using APPN or HPR, it may be advantageous to use APPN or HPR since they require less configuration than running pure APPC for your applications.

To help you choose your APPC networking protocol, consider the following:

- HPR provides a significant enhancement over APPN in terms of network availability by establishing and maintaining end-to-end connections and the ability to switch paths transparently. For HPR, segmentation and reassembly are accomplished in the central processing unit (CPU). For APPN, the segmentation and reassembly happen in the input/output processor (IOP). This HPR capability of being able to transparently switch paths comes with additional central processing (CPU) usage as compared to APPN.
- Enterprise Extender is a networking architecture that allows Systems Network Architecture (SNA) applications to run over Internet Protocol (IP) networks using High Performance Routing (HPR). This is the preferred way to run SNA applications over IP networks with communications input/output adapters (IOAs), such as Gigabit Ethernet, since these IOAs do not require an input/output processor (IOP). Communications adapters that do not use an IOP do not support SNA, therefore, Enterprise

- | Extender is required to run SNA over these adapters. IBM recommends that Enterprise Extender be used in place of AnyNet. For more information, see Migration from AnyNet to Enterprise Extender.
- | • The choice of which protocol to use really comes down to deciding whether the high availability features of HPR are desirable in your environment. When determining whether to use APPN or HPR, you should consider the following:
 - The high-availability feature of HPR
 - The feasibility of higher CPU usage for your environment with HPR
 - | – The requirement to use HPR with Enterprise Extender

You can control the selection of APPN or HPR easily by manipulating the network attributes. It is just as simple to change from HPR to APPN as it is to change from APPN to HPR. The best way to determine the affect of using HPR and APPN in your environment would be to perform some of your own benchmarks.

Design an APPN and HPR network to optimize communications performance

The following list is a selection of tasks that are aimed at getting better performance from a network.

To optimize performance when designing your network, consider the following:

- **Avoid mesh connectivity**

The number of control program-to-control program (CP-CP) sessions that are configured for each network node (NN) has a direct impact on the performance of a network. Network control information such as topology updates and location searches flow over CP-CP sessions. A consequence of too many CP-CP sessions is that information is sent out to more nodes and the same node multiple times. This increases the network processing that is done. In a mesh-connected network, every NN has a CP-CP session with every other NN, increasing the number of CP sessions in this network. The number of CP-CP sessions in the network should be kept to a minimum while still providing necessary connectivity.

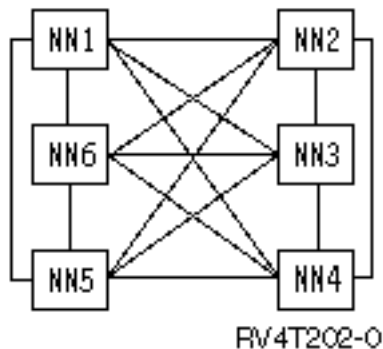

- **Consider backup CP-CP sessions where appropriate**

A CP-CP spanning tree is a term that is used to describe the contiguous path of CP-CP sessions between nodes throughout the network. CP-CP sessions carry necessary control information and are required between NNs in order to participate in the APPN network. Careful analysis to determine the minimal set of links, that support CP-CP sessions, is important. Once these links are identified, it is recommended that back-up links providing alternate CP-CP sessions are added to the network. These backup links ensure availability of the CP-CP spanning tree and are needed if the critical links fail.

- **Consider using border nodes**

APPN architecture does not allow two adjacent APPN NNs to connect and establish CP-CP sessions when they do not share the same network identifier (NETID). Border nodes overcome this restriction. Border nodes enable NNs with different NETIDs to connect and allow session establishment between logical units (LU) in different NETID subnetworks. Border nodes prevent topology information from

flowing across different NETID subnetworks. Use border nodes to subdivide a large APPN network into smaller and more manageable subnetworks. iSeries provides this border node capability for only adjacent networks.

- **Processing reduction for an EN and low-entry networking (LEN) node**

The amount of processing is reduced when the iSeries is an end node or LEN node, as opposed to an NN for the following reasons:

- All network topology, and directory search information flows to every attached network node.
- End nodes and LEN nodes do not receive most of these information flows.

The network nodes (NN) perform route calculation for themselves and other ENs and LEN nodes. (This function flows from the EN or LEN node to the NN.)

- **Reduction of network flows resulting from fewer network nodes**

In addition, topology information about ENs and LEN nodes does not flow through the network. NN topology does flow to the entire network that causes the other network nodes to process information about every other network node.

- **Use Branch Extender**

Branch Extender is an extension to the APPN network architecture. It appears as a network node (NN) to the Local Area Network (LAN), and as an end node (EN) to the Wide Area Network (WAN). This reduces topology flows about resources in the LAN from being disconnected from the WAN. The only topology flows necessary are for network management that identify the types of links.

For more information about setting up Branch Extender, see the page Changing network attributes.

For help in getting optimal performance from you network, see the page Optimizing APPN and HPR communication performance.

Configure APPC, APPN, and HPR

You can configure APPC, APPN, and HPR on your system automatically or manually. The following topics discuss configuration options for your network:

- Automatic configuration on LANs
Understand how APPN and HPR automatically configure controller descriptions on a LAN.
- | • Manual configuration
Find Information about manual configuration.
- | • Configuring Branch Extender support
Find Information about how to configure and take advantage of this feature.
- Connection network support
See this topic for details about connection networks.
- Configuration considerations used to optimize error recovery performance
The way your system is configured makes a significant difference in its performance during communications error recovery.
- Connecting a PC to iSeries using Personal Communications
Find information about connecting personal computers to the iSeries server.
- | • Configuring APPC with VTAM®
Helpful Information about coordinating Virtual Telecommunications Access Method (VTAM) and advanced program-to-program communication (APPC) configuration objects.

Note: Read the code disclaimer information for important legal information.

Automatic configuration on LANs

Automatic configuration support for LANs allows the iSeries server to accept incoming calls from node type 2.1 systems (for example, iSeries servers and personal computers). This can only be supported if a controller description is not varied on that has a matching LAN address of the calling system. The system can be told which parameters to use for the controller descriptions that get automatically created and

varied on. If the line has been defined to allow automatic creation of controller descriptions, then the system creates and varies on an APPC controller description that specifies APPN(*YES). This support allows for automatic creation, automatic vary on, automatic vary off, and deletion of these APPC controller descriptions, and their attached device descriptions.

Notes:

1. An operator may vary on, vary off, or delete automatically created controller descriptions.
2. Only APPC controller descriptions automatically configure on a LAN.

If you are using model controller descriptions see the page, Communication considerations using model controllers.

For more information, see Controlling automatic configuration.

Determine parameters during automatic configuration

The system can be told which parameters should be used for the controller descriptions that get automatically created and varied on. If a model controller description does not exist for a line that supports automatic configuration, then the automatically created, or varied on controller descriptions use the system-supplied defaults for the various parameters. There are two types of parameters that are specified in the automatically configured controller descriptions:

- Those found during the automatic configuration
- Those specified in the model controller or in the system-supplied defaults

Those found during automatic configuration do not use the values that are specified in the model controller or any system values. They are found when the adjacent system on the LAN calls the iSeries system and participates in a swapping of exchange station IDs (XID). A description of these parameters are as follows:

RMTNETID

Remote network identifier.

RMTCPNAME

Remote control-point name.

ADPTADR

LAN adapter address of the remote system.

SSAP Source service access point for the connection.

DSAP Destination service access point for the connection.

NODETYPE

Set to *LENNODE if the remote system does not supply a control-point name on its XID. Otherwise, it is set to *CALC.

TMSGRPNBR

Set to *CALC since the system negotiates this value with the adjacent node.

CPSSN

Set to *NO if the NODETYPE parameter in the automatically configured controller gets set to *LENNODE. Otherwise, it is set to *YES. The system determines if it needs to establish a CP-CP session with the adjacent node. This is determined based on the network server list (if the local system is an end node), or the adjacent system's request for CP session services.

SWTLINLST

Set to the token ring, Ethernet, DDI, or WLS line the call was received on. For automatically configured controller descriptions, there is only one line that is listed in the SWTLINLST. The system may change this parameter for automatically configured controllers that already exist.

The other parameters in the automatically created controller descriptions are copied from the model controller description (if the model controller associated with the line that the call was received on is varied on), or are system-supplied defaults. An exception to using system-supplied defaults is the ONLINE parameter. It is set to *NO for automatically configured controller descriptions since various systems may be automatically configured (such as personal computers, iSeries systems, and System/36s), and you may not want all systems varied on at initial program load (IPL).

APPC controllers that are automatically created on a LAN have the CTLOWN (control owner) parameter set to *SYS since the system controls that controller description. If an operator wishes to change any parameters in a controller that was created automatically, the CTLOWN parameter needs to be set to *USER. By setting this parameter to *USER, the system does not automatically vary on, change, or delete this controller description. The operator now owns this controller description.

Automatic creation and vary on of the controller description

When APPN support determines that it needs a controller description automatically varied on, it determines if there are any existing controller descriptions that follow the naming convention for automatically created APPC controllers.

Naming convention for controller descriptions:

- The first controller description created has the same name as the CP name of the adjacent system
- Additional controller descriptions created use the following conventions:

CPNAMExx

Where CPNAME is the adjacent system's control-point name and xx is some value from 00-FF.

If the adjacent system does not send a control-point name, then the local system creates a name that is based on the adjacent system's EXCHID value. The format of the name is:

CIIIIxx

Where C is a constant value, IIII is the exchange identifier (that is not including the three-digit block number), and xx is some value from '00-FF'.

For an existing controller description to be considered a possible candidate for being automatically varied on, it must:

- Satisfy the naming convention
- Be an APPC controller description
- Be in a varied off status
- Have RMTCPNAME and RMTNETID parameters that match the incoming XID parameter
- Have LINKTYPE parameter specified as *LAN.

If no controllers are found that meet these initial requirements for automatic vary on, then the system creates a new controller. The name of this controller will be the first available name that follows the naming convention for this remote control-point name, and the controller description will indicate that the controller owner is the system (CTLOWN(*SYS)).

Automatic vary off and deletion of controller descriptions

The automatic vary off and delete function is controlled by the AUTODLTCTL parameter in the line description. When a controller description that specifies CTLOWN(*SYS) is varied on manually or automatically:

- The system copies the current value of the AUTODLTCTL parameter associated with the controller description.
- When a controller goes to a vary on pending status, a timer based on the AUTODLTCTL parameter is started. If this controller remains in a vary on pending status, and it is not varied off manually by the operator for the entire time specified by the AUTODLTCTL parameter, then the system automatically varies off and deletes the controller description and all of its attached APPN device descriptions.

| For more Information about this page, see Considerations for the automatic deletion of APPC controller
| descriptions on the LAN.

Communication considerations using model controllers

When MDLCTL(*YES) is specified, it is treated differently than other APPC controller descriptions.

The following are some considerations for model controller descriptions:

- Device descriptions cannot be attached to model controllers.
- Model controllers only go to a status of varied on.

- A model controller can be associated with only one line description at a time. This configuration is done using the SWTLINLST parameter in the model controller.
- The RMTNETID, RMTCPNAME, and ADPTADR parameters are optional parameters when MDLCTL(*YES) is specified.

Note: When a communications session is requested and the local system is an end node, the adjacent system must be specified in the NETSERVER parameter of the CHGNETA command in order for the local system to establish CP-CP sessions with the adjacent system.

- Since model controller descriptions do not represent an actual connection, they are not associated with a line description when using the Work with Configuration Status (WRKCFGSTS) command.

To configure a model controller description, specify MDLCTL(*YES) in an APPC controller description.

Control automatic configuration

You control automatic configuration by the AUTOCTRL parameter in the token ring, Ethernet, DDI, or WLS line descriptions. This parameter can be changed at any time. It is not necessary to vary off controllers that are attached to these line descriptions before changing the AUTOCTRL parameter to *YES or *NO.

Automatic configuration is controlled on a line-by-line basis. That is, one line may specify AUTOCTRL(*YES) and another line may specify AUTOCTRL(*NO). The automatic configuration support for LANs is not related to the QAUTOCFG system value. The setting of QAUTOCFG has no effect on this support.

Note: When you are running APPC over TCP/IP, there is no line that is directly associated with the APPC controller. Therefore, the APPC over TCP/IP controllers LINKTYPE (*ANYNW) must be manually created.

Manual configuration for APPN and HPR

Network attributes describe the local system name, the default local location name, the default control point name, the local network identifier, and the network node type. They also determine whether the system uses HPR, or whether you want to use virtual controllers for APPN. Assuming you have already properly configured an advanced program-to-program communications (APPC) environment, changing network attributes would be your first step in configuring APPN and HPR.

The following are some other steps you may need to perform during your configuration process:

- Define lines with line descriptions. Depending on your hardware, the lines may be attached to a network server, or a network interface.
- Define controllers with controller descriptions. Controller descriptions are attached to lines.
- Define devices or locations with device descriptions. Device descriptions are attached to controllers.
- “Create APPN location lists” on page 10
- “Create mode descriptions” on page 10
- “Create a class-of-service description” on page 11

Change network attributes

Network attributes describe the local system name, the default local location name, the default control point name, the local network identifier, and the network node type. If the machine is an end-node, the attributes also contain the names of the network servers that are used by this iSeries system. Network attributes also determine whether the system uses HPR, or whether you want to use virtual controllers for APPN.

To change the network attributes, do the following:

1. Vary off all APPC and host controllers. The easiest way to do this is to use:

```
VRYCFG CFGOBJ(*APPN) CFGTYPE(*CTL)
STATUS(*OFF) RANGE(*NET)
```

Note: When using automatic creation of controllers on LANs and you vary off the controllers, you have approximately 2 minutes before the iSeries automatically varies on the controllers again. If you have many configuration objects, temporarily turn off APPN auto-creation on the LAN line by using the command CHGLINxxx AUTOCRTCTL(*NO), where xxx is TRN, ETH, DDI, or WLS. When you have changed the necessary network attribute, use the command CHGLINxxx AUTOCRTCTL(*YES) to resume normal APPN function.

2. Type the Change Network Attributes (CHGNETA) command on any iSeries command line and press F4.
3. Use the online help information to complete the parameter values.
4. Press the Enter key. The network attributes are changed.
5. Vary on all the controllers that were varied off in the first step. Use:

```
VRYCFG CFGOBJ(*PRVCFGTYPE) CFGTYPE(*CTL)
        STATUS(*ON) RANGE(*NET)
```

Note: The VRYCFG of *APPN will find **all** APPN controllers and devices on the system and will try to vary them off. The VRYCFG with *PRVCFGTYPE will then try to vary them **all** on.

Configuring APPN virtual controllers

On the iSeries, local applications that need to establish LU 6.2 sessions to other locations in the APPN network require an APPC device description that specifies APPN(*YES). For simplicity, these devices are referred to as APPN devices. Multiple device descriptions can be created and used simultaneously to communicate between the same local location and the remote location pair. After a session is established, the controller description continues to use the same APPN device description for the life of that session.

To configure virtual controllers, do the following:

- Set the ALWVRTAPPN network attribute to (*YES)

After this is done, existing APPN device descriptions (attached to a real controller description) will no longer be used.

If you do not want to use virtual APPN support:

1. Vary off the attached controller
2. Change the ALWVRTAPPN network attribute
3. Vary the controller back on

The APPN device can now be varied on.

Note: This does not affect HPR since it always uses virtual APPN support.

If you are using the HPR tower option (RTP):

1. Vary off all APPN controllers. Use:

```
VRYCFG CFGOBJ(*APPN) CFGTYPE(*CTL)
        STATUS(*OFF) RANGE(*NET)
```
2. Set the Allow HPR transport tower support (ALWHPRTWR) parameter to (*YES)
3. Vary on all your APPN controllers. Use:

```
VRYCFG CFGOBJ(*PRVCFGTYPE) CFGTYPE(*CTL)
        STATUS(*ON) RANGE(*NET)
```

Configuring APPN using Branch Extender

To use Branch Extender, see the page Configuring Branch Extender support.

For more information about Branch Extender, see the page Designing an APPN and HPR network to optimize communications performance.

Considerations for system names

Use caution when you use names with the special characters # ('X'7B'), \$ ('5B'), and @ ('7C'). These special characters might not be on the keyboard of the remote system. These special characters are not supported for APPC over TCP/IP (network IDs and location names only). The use of these symbols should be limited to migration of the operating system. Do not use these characters for newly created names.

If you are using a national language keyboard that does not have the #, \$, or @ symbols, see the appendix on national language keyboard types and the appendix on code pages in the national language keyboard types topic in the Information Center.

The names that may be exchanged with remote systems include the following:

- Network IDs
- Location names
- Mode names
- Class-of-service names
- Control-point names
- Connection network names

Create an APPC controller description

A controller description defines the adjacent systems in the network.

- The use of Advanced Peer-to-Peer Networking[®] (APPN) support is indicated by specifying APPN(*YES) when creating the controller description.
- The use of high-performance routing (HPR) support is indicated by specifying HPR(*YES) when creating the controller description.

To create controller descriptions, do the following:

1. Type one of these commands on any iSeries command line for the type of controller you need to define and press F4.
 - Create Controller Description (APPC) (CRTCTLAPPC)
 - Create Controller Description (Systems Network Architecture (SNA) HOST) (CRTCTLHOST)
2. Use the online help information to choose the correct parameter values.
3. Press Enter. The controller description is created.

| To specify AnyNet support, you must specify *ANYNW on the LINKTYPE parameter of the
| CRTCTLAPPC command. To specify Enterprise Extender support (SNA over IP using HPR), you must
| specify *HPRIP on the LINKTYPE parameter of the CRTCTLAPPC command. Use the online help
| information to choose the correct parameter values.

Note: An APPC controller description is automatically created when the following is true:

- The AUTOCRTCTL parameter on a token-ring, Ethernet, wireless, or distributed data interface (DDI) line description is set to *YES.
- The system receives a session start request over the line from a system without an existing controller.

Create device descriptions for APPC connections

A device description for APPC connections describes the characteristics of the physical or program device that is to communicate with the local system. Device descriptions can describe a physical device (such as an Advanced Function Printing[™] device) or logically represent a communications session or a program running on another system.

| **Note:** The device description is typically created after the controller description. Device descriptions for
| Advanced Peer-to-Peer Networking (APPN), Transmission Control Protocol/Internet Protocol
| (TCP/IP), Internetwork Packet Exchange (IPX), and user-defined communications are typically
| created automatically. When the Create Device Description (APPC) command is used to create
| APPN devices, the APPN parameter must be set to *YES.

The system automatically creates devices for APPN communications. However, other device types are valid for APPC and APPN.

If you need to create a device description, do the following:

1. Type one of these commands on the iSeries command line for the type of device you are creating and press F4:
 - Create Device Description (APPC) (CRTDEVAPPC)
 - Create Device Description (Display) (CRTDEVDSP)
 - Create Device Description (Host) (CRTDEVHOST)
 - Create Device Description (Printer) (CRTDEVPRT)
 - Create Device Description (SNA Pass-through) (SNPT)) (CRTDEVSNPT)
 - Create Device Description (SNA upline facility (SNUF)) (CRTDEVSNUF)
2. Use the online help information to choose the parameter values.
3. Press Enter. The device description is created.

Create APPN location lists

APPN locations define special characteristics of remote locations for APPN. Special characteristics of remote locations include whether the remote location is in a different network from the local location and security requirements for both. If special characteristics of remote locations exist, an APPN remote location list is required.

One local location name is the control point name that is specified in the network attributes. If you need additional locations for the iSeries system, an APPN local location list is required.

Note: QAPPNSSN and QAPPNDIR are two special configuration lists that can be manually configured to —+make your system secure.

To create APPN location lists, do the following:

1. Type the Create Configuration List (CRTCFGL) command on any iSeries command line and Press F4.
2. Specify *APPNLCL for the configuration list type (Type parameter).
3. Use the online help information to choose the correct parameter values.
4. Press Enter. The APPN location list is created.

Create mode descriptions

Mode descriptions describe the session characteristics (including the number of sessions) that are used to negotiate the allowable values between the local and remote locations. The iSeries mode descriptions are used only by APPC, APPN, and HPR support.

Note: The system ships with several mode descriptions. You probably will not need to create one. You can use the Work with Mode Descriptions (WRKMODD) command to find out which mode descriptions already exist on your system.

The mode description also specifies a Class-of-Server Description (COSD) that is used if and when this mode is used to cross an APPN network.

If you need to create a mode description, do the following:

1. Type the Create Mode Description (CRTMODD) command on any iSeries command line and press F4.
2. Use the online help information to choose the parameter values.
3. Press Enter. The mode description is created.

In order for APPN and HPR to choose an optimal route at any given point in time, the pre-established sessions and locally controlled parameters should be set to **zero**.

Notes:

1. If pre-established sessions are not set to zero, the first time the mode is started (through session establishment or by using the STRMOD command) APPN and HPR will establish the number of sessions specified. These sessions remain up even if conversations are not active.

2. If locally controlled sessions are not set to zero, (through session establishment, or by using the STRMOD command) APPN and HPR establish one session that will not be taken down at conversation end.

Create a class-of-service description

A class-of-service description tells the system which network nodes and transmission groups are acceptable and, of those acceptable, which are preferred during route selection. The descriptions can include information such as transmission priority, link speed, cost-per-connection time, and security. Class-of-service descriptions are used only by APPN and HPR.

To create a Class-of-service description, do the following:

1. Type the Create Class-of-Service Description (CRTCOSD) command on any iSeries command line and press F4.
2. Use the online help information to choose the parameter values.
3. Press Enter. The class-of-service description is created.

Configure Branch Extender support

Branch Extender is an extension to the APPN network architecture that appears as a network node (NN) to the Local Area Network (LAN), and as an end node (EN) to the Wide Area Network (WAN). This reduces topology flows about resources in the LAN from being disconnected from the WAN. The only topology flows necessary are for network management identifying the types of links.

To configure Branch Extender:

1. Set the NODETYPE parameter in the network attribute to *BEXNODE
2. Set the BEXROLE controller parameter. This specifies the role of the local system in an APPN network for the remote controller being configured. The two options for BEXROLE are:
 - *NETNODE: The local system takes the role of a network node for the remote controller.
 - *ENDNODE: The local system takes the role of an end node for the remote controller.

Connection network support

A connection network allows APPN support to find addressing information about another system on a LAN when a connection needs to be established. The connection network is an enhancement of automatic configuration since the iSeries system determines addressing information for outgoing calls and automatically creates the associated controller description. Without connection network support, one of the two systems making a connection would be required to have the other system's LAN address and other controller information manually configured. The main benefits for using connection network support are:

- It requires less manual definition of controller descriptions.
- It provides direct, any-to-any connectivity with other systems that are defined to the same connection network instead of using intermediate routing.
- It reduces the amount of information in the APPN topology database and decreases the number of topology updates sent to other systems.

| For Information about how to take part in a connection network see Requirements to participate in a
| connection network. The page, Connection network configuration considerations gives you some points
| to keep in mind when configuring your connection network.

Requirements for an APPN connection network

To participate in an APPN connection network, a system needs to have a CP-CP session established with a network node and a model controller description configured. Other points to consider:

- A System/36™ does not support connection networks, so an iSeries end node that wants to participate in a connection network must not have a System/36 listed as a possible server in its network server list. Requirements to define this connection network are:

- Supply the connection network identifier (CNNNETID) and connection network control-point name (CNNCPNAME) in the model controller description that is associated with the token ring, or Ethernet line description.
- All systems connected to the same LAN (that want to participate in the connection network) must specify the same value for their CNNNETID and CNNCPNAME parameters.
- For a connection network defined on a LAN, the local address that is used is a combination of the LAN adapter address (taken from the token ring or Ethernet line description) and the source service access point (SSAP) (taken from the model controller description that describes the connection network).
- Network nodes have the ability to establish CP-CP sessions that are initiated by other nodes on the LAN. The destination systems with which CP-CP sessions need to be established can be supplied in the model controller description by specifying the RMTNETID, RMTCPNAME, and ADPTADR parameters.

Connection network configuration considerations

Following are two examples showing incorrect configuration of a connection network. The correct configuration of the same example follows:

- Parallel TGs to the same connection network are not allowed. Only one LAN line description may be associated with a connection name.

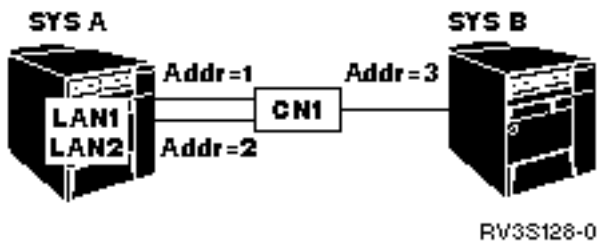

Figure 1. Incorrect configuration showing parallel TGs to a connection network

- There can be only one connection network name that is associated with a LAN line description at any given time.
- One iSeries system (SYS A) has two LAN line descriptions (with a separate connection network that is defined on each), and another iSeries system (SYS B) has two connection network names defined on one LAN line. If SYS A were to request multiple sessions to SYS B, the first session may go over CN1. Another session initiation request might choose CN2. However, the destination address is the same, so the second controller description can not be varied on.

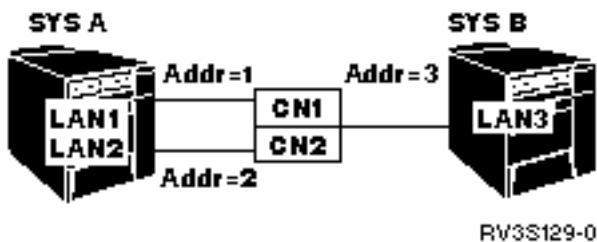

Figure 2. Incorrect configuration showing two connection networks on the same line

- Multiple connection networks (that have different connection network names) may be defined on separate LAN lines.

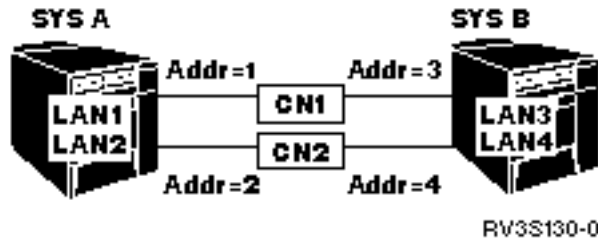

Figure 3. Correct configuration showing two connection networks and two LAN lines

Note: The name of a virtual node cannot be the same as the control-point name of any network node, or end node. That is, the CNNNETID and CNNCPNAME parameters cannot be the same as the RMTNETID and RMTCPNAME parameters in any controller descriptions in the entire APPN network.



Configuration considerations used to optimize error recovery performance

How your system is configured makes a significant difference in the performance of it during communications error recovery.

The following are links to communications configuration considerations that may have a significant effect on error recovery.

- “General configuration considerations for improved error recovery performance”
- “Considerations for communications-related system values” on page 14
- “Considerations for network attributes that can affect APPC error recovery” on page 15
- “Considerations for line configuration settings that can affect error recovery” on page 15
- “Considerations for controller configuration descriptions that can affect error recovery” on page 17
- “Considerations for modes that can affect error recovery” on page 20
- “Considerations for jobs that can affect error recovery” on page 20

See the following references for more detail:

- For advanced configuration pages, see the Communications Configuration  book.
- For more information about iSeries communications, see the Communications Management  book.

General configuration considerations for improved error recovery performance

Careful use of the ONLINE general configuration parameter is necessary to avoid unnecessary communications error recovery. Most communications configuration objects are created with the ONLINE parameter default set to *YES (except for PPP lines, the ONLINE parameter is set to *NO). Consider the setting of the ONLINE parameter in any of the following:



- CRTCTLxxx commands
- CRTDEVxxx commands
- CRTLINxxx commands
- CRTNWIxxx commands
- CRTNWS command

Note: For the network server (NWS) command, you should set the ONLINE parameter value to *NO. If network server descriptions are brought online during the system initial program load (IPL), important system jobs might be held up and unavailable for other work.

When choosing how to set the ONLINE parameter, consider the following:

- Limit the configuration objects that vary on during IPL with the ONLINE parameter set to *YES. These objects should be only those like tape drives, CD-ROM drives, and selected local workstations that are critical to getting your applications up and available for general system use.
- Place critical users in a subsystem group, and vary on configuration objects for this group by using the ONLINE parameter that is set to *YES. This allows critical users to get back online sooner.
- For noncritical users, vary on configuration objects at a later point by setting the ONLINE parameter to *NO. Use a CL program or change the system startup program to manage vary on of the remaining configuration objects.
- For controllers on local area networks (LAN), set the auto-configuration parameter (AUTOCRTCTL) to *YES on the appropriate LAN controller descriptions. Let the system vary these controller descriptions on as needed.
- Whenever possible, avoid varying on any configuration that would fail in attempts to connect to remote systems. For example, avoid varying on controllers with a link type of *LAN that have an initial connection of *DIAL, when remote systems are not available. Personal computers on local area networks (LANs) typically do not respond to connection attempts.

See the following references for more detail:

- For advanced configuration pages, see the Communications Configuration  book.
- For more information about iSeries communications, see the Communications Management  book.

Considerations for communications-related system values

System values, such as system date and library list, control information for the operation of certain parts of the system. You can change the system value to define your working environment.

The following information explains more about each of the system values for communications error recovery.

- **QCMNARB** (communications arbiters): controls the number of communication arbiter system jobs that are available to process communications functions.
 - Do not set this value to zero unless directed by software service. If this system value is set to zero, the work is performed in the QSYSARB and QLUS system jobs as opposed to being performed by the communication arbiters.
 - The QCMNARB system value supports the following values: *CALC, 0-99.
 - *CALC is the default setting for this system value. The system determines the number of jobs based on the system's HW configuration.
 - Consider having more than one QCMNARB job if there is an excessive amount of these system activities.
 - A change to this value requires an initial program load (IPL) of the system for it to take affect.
- **QPASTHRSVR** (pass-through servers): controls how many pass-through server jobs are available for processing display station pass-through requests.
 - The default setting of this system value is calculated based on the hardware configuration of your system.
 - Consider multiple pass-through server jobs in error recovery situations to make the system quicker.

Note: Setting the QPASTHRSVR value to 0 is not recommended. The QPASTHRSVR value of 0 is intended for use in migrating from the use of communications jobs for the 5250 target display station pass-through function to use the pass-through server jobs.

- **QCMNRCYLMT** (communications recovery limit): controls the number of automatic recovery attempts to make. It also controls when an inquiry message is sent to the system operator when the specified number of recovery attempts has been reached.
 - If the CMNRCYLMT parameter value is specified as *SYSVAL for a network interface description, a line description, or a controller description, then the QCMNRCYLMT value is also used. These parameter values also contain a count limit and time interval.

The count limit can be 0 (no recovery attempted) to 99. The time interval can be 0, or a value from 1 to 120 (minutes). A count limit of 0, and a time interval of more than 0 effectively disables automatic

second-level error recovery. This may cause the devices and controllers to go into recovery pending (RCYPND) state, and require operator intervention. A count limit of more than 0, and a time interval of 0 allows automatic second-level error recovery continuously. However, this is not recommended.

Note: To avoid looping recovery, keep the number of retries small; you do not want time to expire before the number of retries are exceeded. Otherwise, you will end up in infinite recovery.

- **QDEVRACYACN** (device I/O recovery action): Controls the recovery action to take for the job when a device error is encountered on a reading and writing operation on the *REQUESTER device for interactive jobs.
- For more information about iSeries communications, see the Communications Management and Work Management  books.

- l • For more Information about pass-through server jobs, see the Remote Work Station Support  book.

Considerations for network attributes that can affect APPC error recovery

Network attributes control information about the communications environment. Allow APPN virtual controller support (ALWVRTAPPN), and virtual controller autcreate APPC device limit (VRTAUTODEV) are network attributes that play a role when a communications error occurs.

The following information explains more about each network attribute and how the attribute affects system performance during error recovery.

- Allow APPN virtual controller support (ALWVRTAPPN) controls whether APPN devices should be attached to real APPN controllers, or to a virtual controller.
 - The default value is *NO.
 - Use virtual APPN controllers to limit the number of devices that go into error recovery when a failure occurs.
 - May be used to eliminate multiple device descriptions that can get created when multiple routes through the APPN network exist.
- Virtual controller autcreate APPC device limit (VRTAUTODEV) indicates the maximum number of automatically created APPC devices for each virtual controller when the following is true:
 - The Allow APPN Virtual Controller (ALWVRTAPPN) network attribute is *YES.
 - The Allow HPR Transport Tower (ALWHPRTWR) network attribute is *YES.

The VRTAUTODEV network attribute specifies the upper limit for the number of automatically created APPC devices on virtual controllers. The more APPC devices created, the longer it takes the system to do error recovery processing on the controller. The default value on this network attribute is 100. For every 100 new APPN locations that your system communicates, a new virtual APPN controller is created.

Note: Manually created devices may still be created if the VRTAUTODEV parameter value is less than the limit of 254.

For more information about these system values, see the following books:

- For more information about iSeries communications, see the Communications Management and Work Management  books.

Considerations for line configuration settings that can affect error recovery

The following line configuration options can affect system performance during error recovery.

- AUTOCRTCTL(*NO, *YES), see “Considerations for the automatic creation of APPC controller descriptions on the LAN” on page 16
- AUTODLTCTL(1440), see “Considerations for the automatic deletion of APPC controller descriptions on the LAN” on page 16
- Link-level timers and retries

The configuration of link-level timers and retries can have a significant affect on network performance. For a complete list of link-level timers and retries, see the appropriate protocol-specific publication.

Considerations for the automatic creation of APPC controller descriptions on the LAN: The automatic creation of advanced program-to-program communications (APPC) controller and device descriptions is done in the communications arbiters (QCMNARBxx) jobs. Consider changing these default parameters based on your environment and potential error recovery considerations.

When the APPC controller is automatically configured by default, the system sets these values in the APPC controller description:

- Set the ONLINE parameter to *NO.
- Set the INLCNN parameter to *DIAL.
- Set the DIALINIT parameter to *LINKTYPE.
- Set the APPN parameter to *YES.
- Set the SWTDSC parameter to *YES.
- Set the MINSWTSTS parameter to *VRYONPND.
- Set the AUTODLTDEV parameter to 1440.



Note: The default settings above may not be desirable for your network. If this is the case, consider using a model controller and change these parameter values if you find unnecessary recovery attempts.

When configuring your LAN, use the AUTOCRTCTL parameter on the following commands:

- CHGLINDDI
- CHGLINETH
- CHGLINTRN
- CHGLINWLS
- CRTLINDDI
- CRTLINETH
- CRTLINTRN
- CRTLINWLS

Note: The AUTOCRTCTL function finds and varies on existing APPN controller descriptions if a matching one is found. Thus, you can use the AUTOCRTCTL function to eliminate the need to vary on the configuration objects at initial program load (IPL) time. The system varies them on as needed.

See the following references for more detail:

- For advanced configuration pages, see the Communications Configuration  book.
- For more information about iSeries communications, see the Communications Management  book.
- For more information about model controllers see Communication considerations using model controllers.

Considerations for the automatic deletion of APPC controller descriptions on the LAN: The system is set to automatically delete APPC controllers and devices that were automatically created. The time interval to delete APPC controller is set to 1440 minutes or 24 hours. For virtual APPN controllers, the default is 10,000 minutes. The automatic delete controller (AUTODLTCTL) parameter is on the CRTLINxxx and CHGLINxxx commands for local area network (LAN) lines. LAN lines include token ring, Ethernet, wireless, and distributed data interface (DDI).



To configure your LAN line to allow automatic deletion of the APPC controller descriptions, use the following information:

- Consider what time of the day would be the best for all users on the system. If automatic deletion occurred over the weekend, on monday morning all devices would be re-created and increase the system workload.
- Consider when weekends and holidays occur and increase the value of this parameter to take into account the most common working environment.

Note: For personal computers on local area networks, consider using a large value for this parameter (for example, 5 days) to prevent deletions if someone goes on vacation.

- The AUTODLTCTL parameter can help manage the number of objects that are on the system. Multiple routes through the network can lead to multiple sets of configuration objects. This parameter can be used to automate the cleanup of these objects.

See the following references for more detail:

- For advanced configuration pages, see the Communications Configuration  book.
- For more information about iSeries communications, see the page Communications Management  book.

Considerations for controller configuration descriptions that can affect error recovery

The following controller configuration options and device configuration options effect system performance during error recovery.

- AUTODLTDEV(1440), see “Considerations for automatic delete device (AUTODLTDEV) parameter for error recovery”
- INLCNN(*DIAL or *ANS), see “Considerations for the INLCNN parameter that can affect error recovery”
- Switched disconnect, see “Considerations for the SWTDSC parameter that can affect error recovery” on page 18
- APPN minimum switch status, see “Considerations for the MINSWTSTS parameter that can affect error recovery” on page 18
- APPC controller recovery summary, see “APPC controller recovery summary” on page 19
- Disconnect timer, see “Considerations for disconnect timer (DSCTMR) parameter for error recovery” on page 20

Additional controller considerations can be found under “Considerations for the automatic deletion of APPC controller descriptions on the LAN” on page 16.

Considerations for automatic delete device (AUTODLTDEV) parameter for error recovery: Device descriptions that are automatically created by the system also may be automatically deleted by the system. The default is to delete devices that were automatically created after 1440 minutes (24 hours) if they have not been used in that time period.

Specifying the default has the potential side-effect of having device descriptions deleted over the weekend. This can cause a system slow-down. For example, when users reconnect on monday morning (after a 48-hour period of system inactivity), they may discover that they need to re-create their device descriptions.

You may want to have the AUTODLTDEV parameter default to a value larger than 24 hours; 72 hours may be more appropriate to cover weekends. Use a model controller to change this value for an autocreated controller description.

The default value for devices that are attached to automatically created APPN virtual controllers is 10,000 minutes.

Note: Using HPR, or turning on the ALWVRTAPPN network attribute can also solve the problem of having multiple sets of configuration objects because HPR prevents multiple objects from being configured.

Considerations for the INLCNN parameter that can affect error recovery: During error recovery, the actions you take to recover the controller depend on whether the controller description was created with

*DIAL or *ANS specified for the initial connection (INLCNN) parameter. You may need to change this parameter for error recovery. The INLCNN parameter is on the CHGCTLxxx command or the CRTCTLxxx commands.

To configure the INLCNN parameter, consider the following:



- Use the INLCNN parameter that is set to *DIAL for iSeries-to-iSeries connections when either system may initiate a connection with the other.

Note: Whether the system actually attempts to DIAL depends on the setting of the Advanced Peer-to-Peer Networking (APPN), DIALIMMED, MINSWTSTS, and CTLOWN parameters along with the INLCNN parameter.

- Use the INLCNN parameter set to *ANS for iSeries-to-PC connections to avoid unnecessary recovery attempts when the personal computer shuts down.

Note: If the remote system never answers the dial attempt, consider changing the configuration to *ANS to avoid dial failures.

See the following references for more detail:

- For advanced configuration pages, see the Communications Configuration  book.
- For more information about iSeries communications, see the Communications Management  book.



Considerations for the SWTDSC parameter that can affect error recovery: By default, the value for the switched disconnect (SWTDSC) parameter is set to *YES for advanced program-to-program communications (APPC). This setting is the best for switched connections. It allows a switched line to be disconnected when the application is no longer using the line. You may want to consider changing the parameter value for error recovery to eliminate unnecessary disconnections. These unnecessary disconnections cause the iSeries server to do more work to disconnect then later reconnect. A common environment where this occurs is with personal computers on local area networks (LAN) that use the Client Access for Windows® or iSeries Access for Windows licensed program. The SWTDSC parameter is on the CHGCTLxxx or CRTCTLxxx command.

To change the SWTDSC parameter, consider the following:

- For personal computers that are connected to a local area network, set the SWTDSC parameter to *NO. Connections between personal computers with V installed, and the iSeries server may be automatically disconnected if the following conditions exist:
 - The V router is started
 - An application such as a 5250 emulation session or a network drive is *not* running over the connection
 - The application does not start within the time limit that is specified by the disconnect timer (DSCTMR) parameter

Note: If you have a switched line that incurs charges, you should continue to use SWTDSC(*YES).

See the following references for more detail:

- For advanced configuration pages, see the Communications Configuration  book.
- For more information about iSeries communications, see the Communications Management  book.



Considerations for the MINSWTSTS parameter that can affect error recovery: The default value for the Advanced Peer-to-Peer Networking (APPN) minimum switched status (MINSWTSTS) parameter is set to *VRYONPND. Specifying this parameter makes APPN controllers in vary on pending status available

for APPN route selection. You may need to change this parameter value for error recovery. The MINSWTSTS parameter is on the CHGCTLAPPC, the CHGCTLHOST, the CRTCTLAPPC, or the CRTCTLHOST commands.

To change the MINSWTSTS parameter, consider the following:

- Set the MINSWTSTS parameter to *VRYON to limit the routes that APPN recognizes as available. This prevents APPN from selecting routes that have a controller in varied on pending status on one system, but varied off or inoperative on an adjacent system.
- The switched disconnect (SWTDSC) parameter must be set to *NO when using the MINSWTSTS parameter that is set to *VRYON. This makes the connection appear like a leased connection. If you have a switched line, do not use MINSWTSTS(*VRTON).

See the following references for more detail:

- For advanced configuration pages, see the Communications Configuration  book.
- For more information about iSeries communications, see the Communications Management  book.

APPC controller recovery summary: The action the system takes when advanced program-to-program communications (APPC) controller descriptions go into recovery depends on the setting of many parameters. The following tables can help you understand and select the appropriate configuration parameters to best optimize system behavior when APPC controllers representing personal computer clients go into error recovery.

Table 1. When does the iSeries attempt to connect the remote system?

MINSWTSTS	INLCNN	APPN	CTLOWN	Power PC® Off (recovery)	Manual Vary On
*VRYONPND	*DIAL	*YES	*SYS	Dial is attempted	Dial is attempted
*VRYONPND	*DIAL	*YES	*USER	Dial not attempted	Dial is attempted
*VRYONPND	*DIAL	*NO	*SYS	Configuration not allowed	
N/A	*DIAL	*NO	*USER	Dial not attempted	Dial is attempted
*VRYONPND	*ANS	*YES	*SYS	Dial not attempted	Dial not attempted
*VRYONPND	*ANS	*YES	*USER	Dial not attempted	Dial not attempted
*VRYONPND	*ANS	*NO	*SYS	Configuration not allowed	
N/A	*ANS	*NO	*USER	Dial not attempted	Dial not attempted

*Table 2. MINSWTSTS(*VRYON) affects on iSeries attempts to connect to the remote system*

APPN	INLCNN	CTLOWN	SWTDSC	Power PC Off (recovery)	Manual Vary On
*YES	*DIAL	*SYS	*YES	Configuration not allowed	
*YES	*DIAL	*SYS	*NO	Dial is attempted	Dial is attempted
*YES	*DIAL	*USER	*YES	Configuration not allowed	
*YES	*DIAL	*USER	*NO	Dial is attempted	Dial is attempted

Note: In all cases when a dial is attempted, when the remote system is using a PC with Client Access for Windows or iSeries Access for Windows installed, that dial attempt fails with the following message:

CPA57EF to QSYSOPR (Controller contact not successful)

For related information, see:

“Considerations for controller configuration descriptions that can affect error recovery” on page 17

Considerations for disconnect timer (DSCTMR) parameter for error recovery: The disconnect timer (DSCTMR) parameter controls the time before a connection without activity is dropped, or the amount of time to delay the automatic disconnection. The default value is 170 seconds. The range is 0 - 65536 seconds.

The DSCTMR parameter is on the CHGCTLxxx and CRTCTLxxx commands.

For related information, see:

- “Considerations for controller configuration descriptions that can affect error recovery” on page 17

Considerations for modes that can affect error recovery

A **mode description** is a system object that is created for communications devices to describe the session limits and the characteristics of the session. These characteristics can be any of the following:

- The maximum number of sessions allowed
- The maximum number of conversations allowed
- The pacing value for incoming request
- The maximum size of request units
- Other controlling information for the session

You can view, create, change, and work with mode descriptions using the Work with Mode Descriptions (WRKMODD) command.

The QPCSUPP (PC support) mode and QSERVER (server) modes are used by the Client Access for Windows or iSeries Access for Windows licensed program.

Considerations for jobs that can affect error recovery

When a line or controller fails, and the application programs are notified, often you must end those jobs that were running over the line and controller. Those jobs must be started again after the communications resource is recovered. Jobs ending (particularly abnormal job ending) should be considered from a performance perspective as an extremely complex transaction. Use the following links to help you recover from an abnormal job ending.

- Device recovery, see “Considerations for the CMNRCYLMT parameter that can affect error recovery” on page 21
- Prestart jobs, see “Change prestart job entries that can affect APPC error recovery” on page 21
- Joblog generation, see “Joblog considerations that can affect communications error recovery” on page 22
- Using the Change System Job (CHGSYSJOB) commands

The CHGSYSJOB command allows you to change the run priority of a system job. The following are system jobs of interest for communications recovery:

- QCMNARB01 through QCMNARB99
- QSYSCOMM1

In general, these system jobs should be allowed to run at their default, system-provided priority. However, if one of these jobs begins using large amounts of CPU, and is affecting other work on the system, it is possible to lower its priority. Note that this may result in queued-up work for that job.

- Device Wait Timeout

The device wait (DEVWAIT) timeout is used to limit the amount of time a subsystem waits for workstation input/output to complete.

Considerations for the CMNRCYLMT parameter that can affect error recovery: The QCMNRCYLMT system value or the recovery limits (CMNRCYLMT) parameter on the configuration object controls automatic communications error recovery. The CMNRCYLMT parameter is on the CHGCTLxxx, CHGLINxxx, CHGNWIxxx, CRTCTLxxx, CRTLINxxx, or CRTNWIxxx commands. These parameter values contain two related numbers that you can set:

- The number of second-level recovery attempts automatically performed by the system (count limit)
- The length of time (time interval) in which the specified number of second-level recoveries can occur.

The default value on CMNRCYLMT on lines and controllers is two retries within 5 minutes (2 5).

To configure the CMNRCYLMT parameter, consider the following:

- If automatic communication fails for personal computers on a local area network (LAN); and the iSeries attempts to recover the connection, this places unnecessary work on the system.



Note: If automatic communications error recovery is not used, manual recovery is necessary, that requires operator intervention. A good compromise is to set the automatic recovery limits to just one retry.

- Use a count limit 0 and a time interval of more than 0 to turn off second-level error recovery. Turning off second-level recovery may cause the devices and controllers to go into recovery pending (RCYPND) state. A message is sent to QSYSOPR, or the configured message queue, that requires operator intervention. Use manual recovery to either respond to the message in QSYSOPR, or the configured message queue, or vary the objects off and back on.

Note: First-level error recovery is still done. On a LAN, the Inactivity Timer is used to determine if the remote system is still available. Once the inactivity time expires, first-level error recovery is driven by the LANFRMRTY parameter and the LANRSPTMR parameter.

- Write applications that can determine if a failure has occurred, and then handle the errors.
 - Monitor the error messages in QSYSOPR, or the configured message queue, when they occur and handle the condition.
 - Monitor the status of the configuration objects by using Retrieve Configuration Status (QDCRCFGS) and List Configuration Descriptions (QDCLCFGD) application programming interfaces (API).

See the following references for more detail:

- For advanced configuration pages, see the Communications Configuration book. 
- For more information about iSeries communications, see the Communications Management  book.

For related information, see:

- “Considerations for the SWTDSC parameter that can affect error recovery” on page 18
- “Considerations for communications-related system values” on page 14

Change prestart job entries that can affect APPC error recovery: Using prestart jobs greatly reduces startup time of the connection. Jobs are reused rather than ended. After an error, users are able to reconnect more quickly. Prestart job entries are shipped with the system for QCMN, QBASE, and QSERVER for these server jobs. You may want to change the prestart job entries. The prestart job entries depend on the usage of your system and the servers during error recovery situations.

Change the prestart jobs entries as appropriate for your environment.



- Consider the following parameters and their values:
 - STRJOBS(*YES and *NO)
 - INLJOBS
 - THRESHOLD
 - ADLJOBS
 - MAXJOBS
- Use the INLJOB parameter to make a larger number of jobs available for the following reasons:
 - You have many users who will connect to the system.

- The connect processing is to be done as quickly as possible.
- Make sure that the THRESHOLD value is higher than the total number of active users.
- Make sure that the ADLJOBS value is higher than the number of jobs that is used.

Note: As user applications are developed, consider using prestart jobs to reduce program start request startup processing.

Tip: Change prestart job entries for APPC error recovery: To display the inactive prestart jobs, press F14 on the WRKACTJOB display. This display can be used to include jobs that are typically not shown on the WRKACTJOB displays. Inactive prestart jobs show a status of PSRW (program start request wait).

See the following references for more detail:

- For advanced configuration pages, see the Communications Configuration  book.
- For more information about iSeries communications, see the Communications Management  book.
- For more server considerations, see iSeries Access Express.

For related information, see:

- “Joblog considerations that can affect communications error recovery”
- “Work entries”

Joblog considerations that can affect communications error recovery: You should consider whether to generate job logs when an error condition occurs and the active jobs are ended. Producing job logs can use considerable system resources, especially during error recovery in which many jobs end at one time. In this case, it may be better to not generate job logs. If you do not produce job logs, you will not have any data for analysis if something goes wrong. There is a trade-off to be made.

To configure your system so that job logs are not generated, do the following:



- Set the DEVRCYACN parameter to *ENDJOBNOLOG. There is also a QDEVRCYACN system value for ease of configuration.

Note: The QDSCJOBITV system value determines when the unused disconnected jobs are ended.

- Change the job description (or the job itself through an initial program for the user profile) to LOGLVL(4 0 *NOLIST). With this description, the job logs are not generated if jobs end normally, but are generated if jobs end abnormally.

Note: Disconnected jobs also use resources. The System Work Control Block Table can grow, which has other side effects. Do not disconnect from jobs to which you will never reconnect.

If some of your users reconnect after a failure, however, the disconnect options can offer increased performance for them.

- For advanced configuration pages, see the Communications Configuration  book.
- For more information about iSeries communications, see the Communications Management  book.
- For system management pages, see the Work Management  book.

For related information, see:

- “Considerations for jobs that can affect error recovery” on page 20
- “Considerations for communications-related system values” on page 14

Work entries: In a subsystem description, work entries are defined to identify the sources from which jobs can be started in that subsystem. The types of work entries are as follows:

Autostart job entry

Specifies a job that is automatically started when the subsystem is started.

Workstation entry

Specifies one or a group of workstations from which interactive jobs can be started.

Job queue entry

Specifies one of the job queues from which the subsystem can select batch jobs. A batch job is a job that can run independently of a user at a workstation.

Communications entry

Specifies one or a group of communications device descriptions from which communications batch jobs may be started. Communications batch jobs do not use job queues.

Prestart job entry

Identifies an application program to be started to wait for incoming allocation requests.

Connect a PC to iSeries using Personal Communications

To obtain greater benefits from having an iSeries in the workplace, personal computers should be able to connect with the iSeries. This means you can have an iSeries display station anywhere there is a personal computer. Personal Communications is one way to do this.

To configure a Personal Communications session to use SNA communications over a local area network (LAN), do the following:

1. From the **Start** menu, choose **Programs >IBM Personal Communications >Start/Configure Session**.
2. In the Session Manager dialog box, click **New Session**.
3. In the Customize Communication dialog box, select the following:
 - For **Type of host**, select **AS/400**.
 - For **Interface**, select **LAN**.
 - For **Attachment**, select **LAN via IEEE 802.2**.
4. Click **Session parameters**.
5. Enter the session parameters (Screen Size, Session Type, Host Code-Page, and so on) or use the default parameters. If you want to be automatically logged on to the server, click **Configure User Profile** and enter your logon information. For the Workstation ID, use a name. A common choice is to use the location name that is added to the end.
6. Click **OK**.
7. In the Customize Communication dialog box, click **Link Parameters**.
8. In the Configure Local System dialog box, specify the following:
 - Fill in the PC Location name as appropriate for your PC. Click **Next**.
 - Enter the **Net ID** name and the **Partner LU name** . (You can find these names with the Display Network Attributes (DSPNETA) command on the iSeries you want to connect to.) Click **Next**.
9. Accept the defaults in the LAN Device Connection dialog box by clicking **Next**.
10. In the Configure LAN Connection dialog box, fill in the destination address with the LAN adapter address of your iSeries. Typically, SAP and PIU sizes can be set by the default.
11. Click **Next** and then click **Finish**.

Configure APPC with VTAM

You need to coordinate the following Virtual Telecommunications Access Method (VTAM) and advanced program-to-program communication (APPC) configuration objects when configuring APPC with VTAM.

1. The controller description is equivalent to the IBM Network Control Program and Virtual Telecommunications Access Method (NCP/VTAM) PU macros. You can find the information in a controller description in the Extended Services[®] Communication Manager Partner LU profile.
2. The device description is equivalent to the NCP/VTAM logical unit (LU) macro. You can find the information of a device description in Extended Services Communications Manager Partner LU and LU profiles.
3. The mode description is equivalent to the NCP/VTAM mode tables. You can find the information in a mode description in the Extended Services Communications Manager Transmission Service Mode profile and Initial Session Limits profile.

Examples: APPC, APPN, and HPR configuration

The following topics contain examples that illustrate configurations of APPC, APPN, and HPR. HPR is the evolution of Advanced Peer-to-Peer Networking (APPN). HPR enhances APPN data routing performance and reliability, especially when using higher-speed, lower error links. For more information, see the following:

- APPN configuration examples
- HPR configuration examples

This disclaimer information pertains to code examples.

APPN configuration examples

See the following examples for a variety of ways to configure APPN:

- “Example: Two iSeries systems as end nodes using APPN”
- “Example: Two iSeries systems as network nodes using APPN” on page 28
- “Example: Three iSeries systems using APPN” on page 34
- “Example: Two APPN networks with different network IDs linked together” on page 41
- “Example: Multiple iSeries systems using APPN” on page 51

Notes:

1. In all of the examples, default values are used for all parameters not explicitly defined.
2. The name assigned to each description that is created is the same as the name of the destination that is being defined in that description. For example, the line description configured in New York for the connection to Los Angeles is LOSANGEL.
3. Names (such as location names), telephone numbers, exchange identifiers, and other values that shown in the examples are for illustration only. The values you assign to your configuration are dependent on your network requirements.

Note: Read the code disclaimer information for important legal information.

Example: Two iSeries systems as end nodes using APPN

In Figure 4, systems A and B are both configured as end nodes in the network attributes. The only APPN-specific parameter that must be configured is the remote control-point name in the controller description. A device description is not a requirement for an APPN configuration.

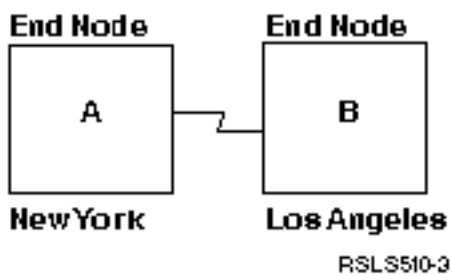

Figure 4. Two-system APPN network

Each list below represents a city within the network in Figure 4 above. See the links in each list to determine the configuration requirements for each system.

New York

- “Example: Configure system A (New York) as an end node” on page 25
- “Change the network attributes (New York) in two-system network” on page 25
- “Create the line description (New York) in two-system network” on page 25
- “Create the controller description (New York) in two-system network” on page 26

Los Angeles

- “Configure system B (Los Angeles) as end node” on page 26
- “Change the network attributes (Los Angeles) in two-system network” on page 27
- “Create the line description (Los Angeles) in two-system network” on page 27
- “Create the controller description (Los Angeles) in two-system network” on page 27

Example: Configure system A (New York) as an end node: The following CL commands are used to define the configuration for the system that is NEWYORK. The example shows the commands as used within a CL program; the configuration can also be performed using the configuration menus.

Note: Read the code disclaimer information for important legal information.

```
/******  
/*  
/* MODULE: NYLAAPPN LIBRARY: PUBSCFGS */  
/*  
/* LANGUAGE: CL */  
/*  
/* FUNCTION: CONFIGURES APPN ENDNODES AS FOLLOWS: */  
/*  
/* NEWYORK /-----\ LOSANGEL */  
/* \-----/ */  
/*  
/* (THIS IS NEWYORK TO LOSANGEL) */  
/******  
PGM  
/******  
/* NEWYORK TO LOSANGEL */  
/******  
/* Change network attributes for NEWYORK */  
CHGNETA LCLNETID(APPN) LCLCPNAME(NEWYORK)  
LCLLOCNAME(NEWYORK) NODETYPE(*ENDNODE)  
/* Create line description for NEWYORK to LOSANGEL */  
CRTLINS DLC LIND(LOSANGEL) RSRCPNAME(LIN011)  
/* Create controller description for NEWYORK to  
LOSANGEL */  
CRTCTLAPPC CTLD(LOSANGEL) LINKTYPE(*SDLC) LINE(LOSANGEL)  
RMTNETID(APPN) RMTCPNAME(LOSANGEL)  
STNADR(01) NODETYPE(*CALC)  
ENDPGM
```

Change the network attributes (New York) in two-system network: Use the Change Network Attributes (CHGNETA) command to set the attributes for the system within the network. The following attributes are for NEWYORK:

LCLNETID(APPN)

Specifies that the name of the local network is APPN. The remote location (LOSANGEL) must specify this name as the remote network identifier (RMTNETID) on the CRTCTLAPPC command.

LCLCPNAME(NEWYORK)

Specifies that the name assigned to the local control point is NEWYORK. The remote system specifies this name as the remote control point name (RMTCPNAME) on the CRTCTLAPPC command.

LCLLOCNAME(NEWYORK)

The default local location name is NEWYORK. This name will be for the device description that is created by the APPN support.

NODETYPE(*ENDNODE)

Specifies that the local system (NEWYORK) is an APPN end node.

Create the line description (New York) in two-system network: The line used in this example is an SDLC nonswitched line. The command used to create the line is Create Line Description (SDLC) (CRTLINS DLC). The parameters specified are:

LIND(LOSANGEL)

The name assigned to the line description is LOSANGEL.

RSRCNAME(LIN011)

Specifies that the physical communications port named LIN011.

Create the controller description (New York) in two-system network: Because this is an APPN environment (iSeries system to iSeries system), the controller is an APPC controller, and the CRTCTLAPPC command defines the attributes of the controller. The example command defines the following attributes:

CTLD(LOSANGEL)

The name assigned to the controller description is LOSANGEL.

LINKTYPE(*SDLC)

Because this controller is attached through an SDLC communications line, the value specified is *SDLC. This value must correspond to the type of line in use defined by a create line description command.

LINE(LOSANGEL)

Specifies the name (LOSANGEL) of the line description to which this controller is attached. This value must match a name that is specified by the LIND parameter in a line description.

RMTNETID(APPN)

The name of the network in which the remote control point resides is APPN.

RMTCPNAME(LOSANGEL)

Specifies that the remote control-point name is LOSANGEL. The name specified here must match the name that is specified at the remote system for the local control-point name. In the example, the LCLCPNAME parameter of the CHGNETA command specifies the name at the remote system (LOSANGEL) by:

STNADR(01)

The address assigned to the remote controller is hex 01.

NODETYPE(*CALC)

Specifies that the local system must determine, during exchange identifier processing, the node type of the remote system.

Configure system B (Los Angeles) as end node: The following CL commands define the configuration for the system that is identified as LOSANGEL (System B). The example shows the commands as used within a CL program; the configuration can also be performed using the configuration menus.

Note: Read the code disclaimer information for important legal information.

```
/******  
/*  
/* MODULE: LANYAPPN LIBRARY: PUBSCFGS */  
/*  
/* LANGUAGE: CL */  
/*  
/* FUNCTION: CONFIGURES APPN ENDNODES AS FOLLOWS: */  
/**  
/* NEWYORK /_____\  
/* \_____/ LOSANGEL  
/*  
/* (THIS IS LOSANGEL TO NEWYORK) */  
/*  
/******  
PGM  
/******  
/* LOSANGEL TO NEWYORK */  
/******  
/* Change network attributes for LOSANGEL */
```



```

CHGNETA    LCLNETID(APPN) LCLCPNAME(LOSANGEL)
           LCLLOCNAME(LOSANGEL) NODETYPE(*ENDNODE)
/* Create line description for LOSANGEL to NEWYORK */
CRTLINS DLC LIND(NEWYORK) RSRNAME(LIN012)
/* Create controller description for LOSANGEL to
           NEWYORK */
CRTCTLAPPC CTLD(NEWYORK) LINKTYPE(*SDLC) LINE(NEWYORK)
           RMTNETID(APPN) RMTCPNAME(NEWYORK)
           STNADR(01) NODETYPE(*CALC)

```

ENDPGM

Change the network attributes (Los Angeles) in two-system network: Use the Change Network Attributes (CHGNETA) command to set the attributes for the system within the network. The following attributes are for LOSANGEL:

LCLNETID(APPN)

Specifies that the name of the local network is APPN. The remote location (NEWYORK in the example) must specify this name as the remote network identifier (RMTNETID) on the CRTCTLAPPC command.

LCLCPNAME(LOSANGEL)

Specifies that the name assigned to the local control point is LOSANGEL. The remote system specifies this name as the remote control point name (RMTCPNAME) on the CRTCTLAPPC command.

LCLLOCNAME(LOSANGEL)

The default local location name is LOSANGEL. This name is for the device description that is created by the APPN support.

NODETYPE(*ENDNODE)

Specifies that the local system (LOSANGEL) is an APPN end node.

Create the line description (Los Angeles) in two-system network: The line used in this example is an SDLC nonswitched line. The command used to create the line is CRTLINS DLC. The parameters specified are:

LIND(NEWYORK)

The name assigned to the line description is NEWYORK.

RSRNAME(LIN012)

Specifies that the physical communications port named LIN012.

Create the controller description (Los Angeles) in two-system network: Because this is an APPN environment (iSeries system to iSeries system), the controller is an APPC controller and the CRTCTLAPPC command defines the attributes of the controller. The example command defines the following attributes:

CTLD(NEWYORK)

The name assigned to the controller description is NEWYORK.

LINKTYPE(*SDLC)

Because this controller is attached through an SDLC communications line, the value specified is *SDLC. This value must correspond to the type of line in use as defined by a create line description command.

LINE(NEWYORK)

Specifies the name (NEWYORK) of the line description to which this controller is attached. This value must match a name that is specified by the LIND parameter in a line description.

RMTNETID(APPN)

The name of the network in which the remote control point resides is APPN.

RMTCPNAME(NEWYORK)

Specifies that the remote control-point name is NEWYORK. The name specified here must match the

name that is specified at the remote system for the local control-point name. In the example, the LCLCPNAME parameter of the CHGNETA command specifies the name at the remote system (NEWYORK).

STNADR(01)

The address assigned to the remote controller is hex 01.

NODETYPE(*CALC)

Specifies that the local system must determine, during exchange identifier processing, the node type of the remote system.

Example: Two iSeries systems as network nodes using APPN

In Figure 5, both systems are configured as network nodes in the network attributes. This example shows an APPN configuration using a switched line and a nonswitched line.

Configuring Network Node 1 (Chicago)

The following example program shows the CL commands that are used to define the configuration for the system that is identified as CHICAGO (NN1). The example shows the commands as used within a CL program; the configuration can also be performed using the configuration menus.

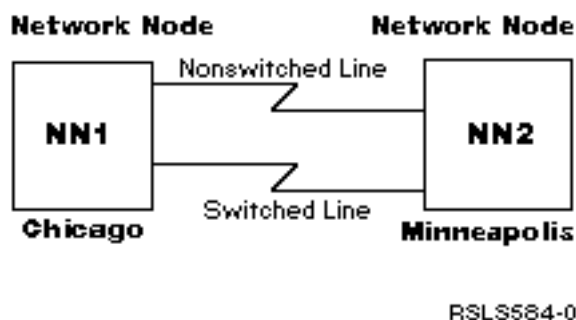

Figure 5. APPN two-system network

Each list below represents a city within the network in Figure 5 above. See the links in each list to determine the configuration requirements for each system.

Chicago

- “Example: Change the network attributes (Chicago) in two-system network” on page 29
- “Create the line description (Chicago to Minneapolis, nonswitched)” on page 30
- “Create the controller description (Chicago to Minneapolis, nonswitched)” on page 30
- “Create the line description (Chicago to Minneapolis, switched)” on page 30
- “Create the controller description (Chicago to Minneapolis, switched)” on page 31

Minneapolis

- “Example: Configure network node 2 (Minneapolis)” on page 31
- “Change the network attributes (Minneapolis) as a network node” on page 32
- “Create the line description (Minneapolis to Chicago, nonswitched)” on page 32
- “Create controller description A (Minneapolis to Chicago)” on page 32
- “Create the line description (Minneapolis to Chicago, switched)” on page 33
- “Create controller description B (Minneapolis to Chicago)” on page 33

Example: Change the network attributes (Chicago) in two-system network: Use the Change Network Attributes (CHGNETA) command to set the attributes for the system within the network. The following attributes are defined for the CHICAGO system, and these attributes apply to all connections in the network for this network node.

Note: Read the code disclaimer information for important legal information.

```

/*****/
/*
/* MODULE: CHICAGO LIBRARY: PUBSCFGS */
/*
/* LANGUAGE: CL */
/*
/* FUNCTION: CONFIGURES APPN NETWORK: */
/*
/* THIS IS: CHICAGO TO MPLS (nonswitched) */
/* CHICAGO TO MPLS (switched) */
/*
/*
/*
/*
/*
/*****/
PGM
        /* Change network attributes for CHICAGO */
        CHGNETA LCLNETID(APPN) LCLCPNAME(CHICAGO) +
                LCLLOCNAME(CHICAGO) NODETYPE(*NETNODE)
/*****/
/* CHICAGO TO MPLS (nonswitched) */
/*****/
        /* Create nonswitched line description for CHICAGO to MPLS */
        CRTLINS DLC LIND(MPLSL) RSRNAME(LIN021)
        /* Create controller description for CHICAGO to MPLS */
        CRTCTLAPPC CTLD(MPLSL) LINKTYPE(*SDLC) LINE(MPLSL) +
                RMTNETID(APPN) RMTCPNAME(MPLS) +
                STNADR(01) NODETYPE(*NETNODE)
/*****/
/* CHICAGO TO MPLS (switched) */
/*****/
        /* Create switched line description for CHICAGO to MPLS */
        CRTLINS DLC LIND(MPLSS) RSRNAME(LIN022) CNN(*SWTPP) +
                AUTOANS(*NO) STNADR(01)
        /* Create controller description for CHICAGO to MPLS */
        CRTCTLAPPC CTLD(MPLSS) LINKTYPE(*SDLC) SWITCHED(*YES) +
                SWTLINLST(MPLSS) RMTNETID(APPN) +
                RMTCPNAME(MPLS) INLCNN(*DIAL) +
                CNNBR(6125551111) STNADR(01) +
                TMSGRPNBR(3) NODETYPE(*NETNODE)
ENDPGM

```

LCLNETID(APPN)

The name of the local network is APPN. The remote system (MPLS in the example program, NN2 in Figure 5 on page 28) must specify this name as the remote network identifier (RMTNETID) on the CRTCTLAPPC command.

LCLCPNAME(CHICAGO)

The name assigned to the local control point is CHICAGO. The remote systems specify this name as the remote control point name (RMTCPNAME) on the CRTCTLAPPC command.

LCLLOCNAME(CHICAGO)

The default local location name is CHICAGO. This name will be used for the device description that is created by the APPN support.

NODETYPE(*NETNODE)

The local system (CHICAGO) is an APPN network node.

Create the line description (Chicago to Minneapolis, nonswitched): The line used in this example is an SDLC nonswitched line. The command used to create the line is CRTLINS DLC. The parameters specified are:

LIND(MPLSL)

The name assigned to the line description is MPLSL.

RSRCNAME(LIN021)

The physical communications port named LIN021.

Create the controller description (Chicago to Minneapolis, nonswitched): Because this is an APPN environment (iSeries system to iSeries system), the controller is an APPC controller, and the CRTCTLAPPC command defines the attributes of the controller. The example command defines the following attributes:

CTLD(MPLSL)

The name assigned to the controller description is MPLSL.

LINKTYPE(*SDLC)

Because this controller is attached through an SDLC communications line, the value specified is *SDLC. This value must correspond to the type of line that is defined by a create line description command.

LINE(MPLSL)

The name of the line description to which this controller is attached is MPLSL. This value must match a name that is specified by the LIND parameter in a line description.

RMTNETID(APPN)

The name of the network in which the remote control point resides is APPN.

RMTCPNAME(MPLS)

The remote control-point name is MPLS. The name specified here must match the name that is specified at the remote system for the local control-point name. In the example, the LCLCPNAME parameter on the Change Network Attributes (CHGNETA) command specifies the name at the remote system (NEWYORK).

STNADR(01)

The address assigned to the remote controller is hex 01.

NODETYPE(*NETNODE)

The remote system (MPLS) is an APPN network node.

Create the line description (Chicago to Minneapolis, switched): The line used in this example is an SDLC switched line. The command used to create the line is CRTLINS DLC. The parameters specified are:

LIND(MPLSS)

The name assigned to the line description is MPLSS.

RSRCNAME(LIN022)

The physical communications port that is named LIN022.

CNN(*SWTPP)

This is a switched line connection.

AUTOANS(*NO)

This system will not automatically answer an incoming call.

STNADR(01)

The address assigned to the local system is hex 01.

Create the controller description (Chicago to Minneapolis, switched): Because this is an APPN environment (iSeries system to iSeries system), the controller is an APPC controller, and the CRTCTLAPPC command defines the attributes of the controller. The example command defines the following attributes:

CTLD(MPLSS)

The name assigned to the controller description is MPLSS.

LINKTYPE(*SDLC)

Because this controller is attached through an SDLC communications line, the value specified is *SDLC. This value must correspond to the type of line that is defined by a create line description command.

SWITCHED(*YES)

This controller attaches to a switched SDLC line.

SWTLINLST(MPLSS)

The name of the line description (for switched lines) to which this controller can be attached is MPLSS. In the example, there is only one line (MPLSS). This value must match a name that is specified by the LIND parameter in a line description.

RMTNETID(APPN)

The name of the network in which the remote control point resides is APPN.

RMTCPNAME(MPLS)

The remote control-point name is MPLS. The name specified here must match the name that is specified at the remote system for the local control-point name. In the example, the LCLCPNAME parameter on the CHGNETA (Change Network Attributes) command specifies the name at the remote system.

INLCNN(*DIAL)

The iSeries system makes the initial connection by either answering an incoming call or placing a call.

CNNNBR(6125551111)

The connection (telephone) number for the remote controller is 6125551111.

STNADR(01)

The address assigned to the remote controller is hex 01.

TMSGRPNBR(3)

APPN support use the value (3) for transmission group negotiation with the remote system.

The remote system must specify the same value for the transmission group.

NODETYPE(*NETNODE)

The remote system (MPLS) is an APPN network node.

Example: Configure network node 2 (Minneapolis): The following example program shows the CL commands that are used to define the configuration for the system that is identified as MPLS (NN2 in Figure 5 on page 28). The example shows these commands as used within a CL program; the configuration can also be performed using the configuration menus.

Note: Read the code disclaimer information for important legal information.

```
/******  
/*  
/* MODULE:  MPLS                LIBRARY:  PUBSCFGS          */  
/*  
/* LANGUAGE:  CL                */  
/*  
/* FUNCTION:  CONFIGURES APPN NETWORK:                    */  
/*  
/*           THIS IS: MPLS TO CHICAGO   (nonswitched)     */  
/*           MPLS TO CHICAGO   (switched)                 */  
/*
```

```

/*                                                                    */
/*****                                                                    */
PGM
    /* Change network attributes for MPLS */
    CHGNETA    LCLNETID(APPN) LCLCPNAME(MPLS) +
              LCLLOCNAME(MPLS) NODETYPE(*NETNODE)
/*****                                                                    */
/*                                                                    */
/*****                                                                    */
    /* Create line description for MPLS to CHICAGO */
    CRTLINS DLC LIND(CHICAGOL) RSRNAME(LIN022)
    /* Create controller description for MPLS to CHICAGO */
    CRTCTLAPPC CTLD(CHICAGOL) LINKTYPE(*SDLC) LINE(CHICAGOL) +
              RMTNETID(APPN) RMTCPNAME(CHICAGO) +
              STNADR(01) NODETYPE(*NETNODE)
/*****                                                                    */
/*                                                                    */
/*****                                                                    */
    /* Create switched line description for MPLS to CHICAGO */
    CRTLINS DLC LIND(CHICAGOS) RSRNAME(LIN031) CNN(*SWTPP) +
              AUTOANS(*NO) STNADR(01)
    /* Create controller description for MPLS TO CHICAGO */
    CRTCTLAPPC CTLD(CHICAGOS) LINKTYPE(*SDLC) SWITCHED(*YES) +
              SWTLINLST(CHICAGOS) RMTNETID(APPN) +
              RMTCPNAME(CHICAGO) INLCNN(*ANS) +
              CNNNBR(312551111) STNADR(01) TMSGRPNBR(3) +
              NODETYPE(*NETNODE)
ENDPGM

```

Change the network attributes (Minneapolis) as a network node: The Change Network Attributes (CHGNETA) command sets the attributes for the system within the network. The following attributes are defined for the MPLS system, and these attributes apply to all connections in the network for this network node:

LCLNETID(APPN)

The name of the local network is APPN. The remote systems (CHICAGO in the example program, NN1 in Figure 5 on page 28) must specify this name as the remote network identifier (RMTNETID) on the CRTCTLAPPC command.

LCLCPNAME(MPLS)

The name assigned to the local control point is MPLS. The remote system specifies this name as the remote control point name (RMTCPNAME) on the CRTCTLAPPC command.

LCLLOCNAME(MPLS)

The default local location name is MPLS. This name is for the device description that is created by the APPN support.

NODETYPE(*NETNODE)

The local system (MPLS) is an APPN network node.

Create the line description (Minneapolis to Chicago, nonswitched): The line used in this example is an SDLC nonswitched line. The command used to create the line is CRTLINS DLC. The parameters specified are:

LIND(CHICAGOL)

The name assigned to the line description is CHICAGOL.

RSRNAME(LIN022)

The physical communications port named LIN022.

Create controller description A (Minneapolis to Chicago): Because this is an APPN environment (iSeries system to iSeries system), the controller is an APPC controller, and the CRTCTLAPPC command defines the attributes of the controller. The example command defines the following attributes:

CTLD(CHICAGOL)

The name assigned to the controller description is CHICAGOL.

LINKTYPE(*SDLC)

Because this controller is attached through an SDLC communications line, the value specified is *SDLC. This value must correspond to the type of line that is defined by a create line description command.

LINE(CHICAGOL)

The name of the line description to which this controller is attached is CHICAGOL. This value must match a name that is specified by the LIND parameter in a line description.

RMTNETID(APPN)

The name of the network in which the remote system resides is APPN.

RMTCPNAME(CHICAGO)

The remote control-point name is CHICAGO. The name specified here must match the name that is specified at the remote system for the local control-point name. In the example, the LCLCPNAME parameter on the Change Network Attributes (CHGNETA) command specifies the name at the remote system (CHICAGO).

STNADR(01)

The address assigned to the remote controller is hex 01.

NODETYPE(*NETNODE)

The remote system (CHICAGO) is an APPN network node.

Create the line description (Minneapolis to Chicago, switched): The line used in this example is an SDLC switched line. The command used to create the line is CRTLINS DLC. The parameters specified are:

LIND(CHICAGOS)

The name assigned to the line description is CHICAGOS.

RSRCNAME(LIN031)

The physical communications port named LIN031.

CNN(*SWTPP)

This is a switched line connection.

AUTOANS(*NO)

This system will not automatically answer an incoming call.

STNADR(01)

The address assigned to the local system is hex 01.

Create controller description B (Minneapolis to Chicago): Because this is an APPN environment (iSeries system to iSeries system), the controller is an APPC controller, and the CRTCTLAPPC command defines the attributes of the controller. The example command defines the following attributes:

CTLD(CHICAGOS)

The name assigned to the controller description is CHICAGOS.

LINKTYPE(*SDLC)

Because this controller is attached through an SDLC communications line, the value specified is *SDLC. This value must correspond to the type of line that is defined by a create line description command.

SWITCHED(*YES)

This controller is attached to a switched SDLC line.

SWTLINLST(CHICAGOS)

The name of the line description (for switched lines) to which this controller can be attached is CHICAGOS. In the example, there is only one line (CHICAGO). This value must match a name that is specified by the LIND parameter in a line description.

RMTNETID(APPN)

The name of the network in which the remote control point resides is APPN.

RMTCPNAME(CHICAGO)

The remote control-point name is CHICAGO. The name specified here must match the name that is specified at the remote system for the local control-point name. In the example, the LCLCPNAME parameter on the Change Network Attributes (CHGNETA) command specifies the name at the remote system (CHICAGO).

INLCNN(*ANS)

The iSeries system makes the initial connection by answering an incoming call.

CNNNBR(3125551111)

The connection (telephone) number for the remote controller is 3125551111.

STNADR(01)

The address assigned to the remote controller is hex 01.

TMSGRPNBR(3)

APPN support uses the value (3) for transmission group negotiation with the remote system.

The remote system must specify the same value for the transmission group.

NODETYPE(*NETNODE)

The remote system (CHICAGO) is an APPN network node.

Example: Three iSeries systems using APPN

In Figure 6, A and B are end nodes. The network node must configure its network attributes to reflect that it is a network node. Each system must configure the remote control-point name in the controller description that represents the adjacent system. Also, A and B must indicate in the controller description for the network node that it can be a network node. A and B must add the network node to the server list in network attributes so that the network node might act as a network server for both end nodes.

Note: Neither end node needs to configure any information about the other end node.

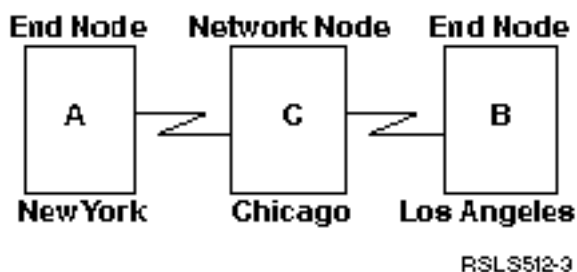

Figure 6. Three-system APPN network

Each list below represents a city within the network in Figure 6 above. See the links in each list to determine the configuration requirements for each system.

New York

- “Example: Configure system A (New York)” on page 35
- “Change the network attributes (New York) in three-system network” on page 36
- “Create the remote location configuration list (New York) in three-system network” on page 36
- “Create the line description (SDLC nonswitched - New York)” on page 36
- “Create the controller description in three-system network (New York)” on page 36

Los Angeles

- “Example: Configure system B (Los Angeles)” on page 37
- “Change the network attributes (Los Angeles) in three-system network” on page 38
- “Create the remote location configuration list (Los Angeles)” on page 38
- “Create the line description (Los Angeles)” on page 38
- “Create the controller description (Los Angeles)” on page 39

Chicago

- “Example: Configure system C (Chicago)” on page 39
- “Change the network attributes (Chicago) in three-system network” on page 40
- “Create the line description (Chicago to New York) in three-system network” on page 40
- “Create the controller description (Chicago to New York) in three-system network” on page 40
- “Create the line description (Chicago to Los Angeles)” on page 41
- “Create the controller description (Chicago to Los Angeles)” on page 41

Example: Configure system A (New York): The following CL commands defines the configuration for the system that is identified as NEWYORK (system A in Figure 6 on page 34). The examples show these commands as used within a CL program; the configuration can also be performed using the configuration menus.

Note: Read the code disclaimer information for important legal information.

```

/*****/
/*
/* MODULE: NYCHENNN                LIBRARY: PUBSCFGS          */
/*
/* LANGUAGE: CL                    */
/*
/* FUNCTION: CONFIGURES APPN EN-NN-EN AS FOLLOWS:           */
/*
/*
/*          NEWYORK /-----\ CHICAGO /-----\ LOSANGEL
/*          \-----/                \-----/
/*
/*          (THIS IS NEWYORK TO CHICAGO)
/*
/*
/*
/*
/*****/
PGM
/*****/
/*          NEWYORK TO CHICAGO          */
/*****/
/* Change network attributes for NEWYORK */
CHGNETA  LCLNETID(APPN) LCLCPNAME(NEWYORK)
          LCLLOCNAME(NEWYORK) NODETYPE(*ENDNODE)
          NETSERVER((APPN CHICAGO))
/* Create remote configuration list for NEWYORK */
CRTCFGL  TYPE(*APPNRMT) APPNRMTE((LOSANGEL APPN
          NEWYORK LOSANGEL APPN 3BD29F *YES *NO *NO *NO
          'RMT LOC of NEWYORK'))
/* Create line description for NEWYORK to CHICAGO */
CRTLINS DLC LIND(CHICAGO) RSRNAME(LIN011)
/* Create controller description for NEWYORK to
          CHICAGO */
CRTCTLAPPC CTLD(CHICAGO) LINKTYPE(*SDLC) LINE(CHICAGO)
          RMTNETID(APPN) RMTCPNAME(CHICAGO)
          STNADR(01) NODETYPE(*NETNODE)
ENDPGM

```

Change the network attributes (New York) in three-system network: The Change Network Attributes (CHGNETA) command is used to set the attributes for the system within the network. The following attributes for NEWYORK:

LCLNETID(APPN)

Specifies that the name of the local network is APPN. The remote location (CHICAGO in the example, system B in Figure 6 on page 34), must specify this name as the remote network identifier (RMTNETID) on the CRTCTLAPPC command.

LCLCPNAME(NEWYORK)

Specifies that the name assigned to the local control point is NEWYORK. The remote system specifies this name as the remote control point name (RMTCPNAME) on the CRTCTLAPPC command.

LCLLOCNAME(NEWYORK)

The default local location name of this location is NEWYORK. This name will be used for the device description that is created by the APPN support.

NODETYPE(*ENDNODE)

Specifies that the local system (NEWYORK) is an end node in the APPN network.

NETSERVER((APPN CHICAGO))

Specifies the name of the network node (CHICAGO) and the name of the network (APPN) that serves this end node. These names are defined at the remote system on the CHGNETA command.

Create the remote location configuration list (New York) in three-system network: The Create Configuration List (CRTCFGL) command is also used to define the remote locations with special characteristics to the APPN support. In this example, location security is being used, and the following is defined at NEWYORK:

TYPE(*APPNRMT)

Specifies that the entries being defined are remote locations.

APPNRMTE((LOSANGEL APPN NEWYORK LOSANGEL APPN 3BD29F *YES *NO *NO *NO 'RMT LOC of NEWYORK'))

Specifies the remote location with which the local location can be paired.

- The remote location name is LOSANGEL
- The remote network ID is APPN
- The associated local location name is NEWYORK
- The remote control-point name is LOSANGEL
- The remote control-point network ID is also APPN
- The password is 3BD29F
- It is a secure location
- It is not a single session location (the last two entries, locally controlled sessions and pre-established sessions, are *NO because this is not a single session location)

Create the line description (SDLC nonswitched - New York): The line used in this example is an SDLC nonswitched line. The command used to create the line is CRTLINS DLC. The parameters specified are:

LIND(CHICAGO)

The name assigned to the line description is CHICAGO.

RSRCNAME(LIN011)

Specifies that the physical communications port named LIN011 is being defined.

Create the controller description in three-system network (New York): Because this is an APPN environment (iSeries system to iSeries system), the controller is an APPC controller and the CRTCTLAPPC command is used to define the attributes of the controller. The following attributes are defined by the example command:

CTLD(CHICAGO)

The name assigned to the controller description is CHICAGO.

LINKTYPE(*SDLC)

Because this controller is attached through an SDLC communications line, the value specified is *SDLC. This value must correspond to the type of line being used as defined by a create line description command.

LINE(CHICAGO)

Specifies the name (CHICAGO) of the line description to which this controller is attached. This value must match a name that is specified by the LIND parameter in a line description.

RMTNETID(APPN)

The name of the network in which the remote control point resides is APPN.

RMTCPNAME(CHICAGO)

Specifies that the remote control-point name is CHICAGO. The name specified here must match the name that is specified at the remote system for the local control-point name. In this example, the LCLCPNAME parameter specifies the name on the CHGNETA command.

STNADR(01)

The address assigned to the remote controller is hex 01.

NODETYPE(*NETNODE)

Specifies that the remote location (CHICAGO) is an APPN networking node.

Example: Configure system B (Los Angeles): The following CL commands are used to define the configuration for the system that is identified as LOSANGEL (system B in Figure 6 on page 34). The examples show these commands as used within a CL program; You can also perform the configuration using the configuration menus.

Note: Read the code disclaimer information for important legal information.

```
/******  
/*  
/* MODULE: LACHENNN LIBRARY: PUBSCFGS */  
/*  
/* LANGUAGE: CL */  
/*  
/* FUNCTION: CONFIGURES APPN EN-NN-EN AS FOLLOWS: */  
/*  
/* NEWYORK /-----\ CHICAGO /-----\ LOSANGEL */  
/* \-----/ \-----/ */  
/*  
/* (THIS IS LOSANGEL TO CHICAGO) */  
/*  
/*  
/*  
/******  
PGM  
/******  
/* LOSANGEL TO CHICAGO */  
/******  
/* Change network attributes for LOSANGEL */  
CHGNETA LCLNETID(APPN) LCLCPNAME(LOSANGEL)  
LCLLOCNAME(LOSANGEL) NODETYPE(*ENDNODE)  
NETSERVER((APPN CHICAGO))  
/* Create remote configuration list for LOSANGEL to  
New York */  
CRTCFGL TYPE(*APPNRMT) APPNRMTE((NEWYORK APPN  
LOSANGEL NEWYORK APPN 3BD29F *YES *NO *NO *NO  
'RMT LOC of LOSANGEL'))  
/* Create line description for LOSANGEL to CHICAGO */  
CRTLINS DLC LIND(CHICAGO) RSRNAME(LIN041)
```

```

/* Create controller description for LOSANGEL to
                                     CHICAGO */
CRTCTLAPPC CTLD(CHICAGO) LINKTYPE(*SDLC) LINE(CHICAGO)
          RMTNETID(APPN) RMTCPNAME(CHICAGO)
          STNADR(01) NODETYPE(*NETNODE)
ENDPGM

```

Change the network attributes (Los Angeles) in three-system network: The Change Network Attributes (CHGNETA) command sets the attributes for the system within the network. The following attributes are for NEWYORK:

LCLNETID(APPN)

Specifies that the name of the local network is APPN. The remote location (CHICAGO in the example) must specify this name as the remote network identifier (RMTNETID) on the CRTCTLAPPC command.

LCLCPNAME(LOSANGEL)

Specifies that the name assigned to the local control point is LOSANGEL. The remote system specifies this name as the remote control point name (RMTCPNAME) on the CRTCTLAPPC command.

LCLLOCNAME(LOSANGEL)

The default local location name of this location is LOSANGEL. This name will be used for the device description that is created by the APPN support.

NODETYPE(*ENDNODE)

Specifies that the local system (LOSANGEL) is an end node in the APPN network.

NETSERVER((APPN CHICAGO))

Specifies the name of the network node (CHICAGO) and the name of the network (APPN) that serves this end node. These names are defined at the remote system on the CHGNETA command.

Create the remote location configuration list (Los Angeles): You can also use the Create Configuration List (CRTCFGL) command to define the remote locations with special characteristics to the APPN support. In this example, location security is being used, and the following is defined at LOSANGEL:

TYPE(*APPNRMT)

Specifies that the entries being defined are remote locations.

APPNRMTE((NEWYORK APPN LOSANGEL NEWYORK APPN 3BD29F *YES *NO *NO *NO 'RMT LOC of LOSANGEL'))

Specifies the remote location with which the local location can be paired.

- The remote location name is NEWYORK
- The remote network ID is APPN
- The associated local location name is LOSANGEL
- The remote control-point name is NEWYORK
- The remote control-point network ID is also APPN
- The password is 3BD29F
- It is a secure location
- The last two entries, locally controlled sessions and pre-established sessions, are *NO because this is not a single session location

Create the line description (Los Angeles): The line used in this example is an SDLC nonswitched line. The command used to create the line is CRTLINS DLC. The parameters specified are:

LIND(CHICAGO)

The name assigned to the line description is CHICAGO.

RSRCNAME(LIN041)

Specifies that the physical communications port named LIN041.

Create the controller description (Los Angeles): Because this is an APPN environment (iSeries system to iSeries system), the controller is an APPC controller, and the CRTCTLAPPC command defines the attributes of the controller. The example command defines the following attributes:

CTLDD(CHICAGO)

The name assigned to the controller description is CHICAGO.

LINKTYPE(*SDLC)

Because this controller is attached through an SDLC communications line, the value specified is *SDLC. This value must correspond to the type of line being used as defined by a create line description command.

LINE(CHICAGO)

Specifies the name (CHICAGO) of the line description to which this controller is attached. This value must match a name that is specified by the LIND parameter in a line description.

RMTNETID(APPN)

The name of the network in which the remote control point resides is APPN.

RMTCPNAME(CHICAGO)

Specifies that the remote control-point name is CHICAGO. The name specified here must match the name that is specified at the remote system for the local control-point name. In the example, the LCLCPNAME parameter on the CHGNETA command specifies the name at the remote system (CHICAGO).

STNADR(01)

The address assigned to the remote controller is hex 01.

NODETYPE(*NETNODE)

Specifies that the remote system (CHICAGO) is an APPN networking node.

Example: Configure system C (Chicago): The following CL commands define the configuration for the system that is identified as CHICAGO (system C in Figure 6 on page 34). The example shows the commands as used within a CL program; the configuration can also be performed using the configuration menus.

Note: Read the code disclaimer information for important legal information.

```

/*****/
/*
/* MODULE:  CHNYCHLA             LIBRARY:  PUBSCFGS             */
/*
/* LANGUAGE:  CL                 */
/*
/* FUNCTION:  CONFIGURES APPN NETWORK:             */
/*
/*
/*          NEWYORK  /_____\  CHICAGO  /_____\  LOSANGEL
/*                  \_____/          \_____/
/*
/*          (THIS IS CHICAGO TO NEWYORK AND LOSANGEL)
/*
/*
/*
/*
/*****/
PGM

          /* Change network attributes for CHICAGO */
          CHGNETA  LCLNETID(APPN) LCLCPNAME(CHICAGO)
                  LCLLOCNAME(CHICAGO) NODETYPE(*NETNODE)
/*****/
/*          CHICAGO TO NEWYORK             */
/*****/
          /* Create line description for CHICAGO to NEWYORK */
          CRTLINS DLC LIND(NEWYORK) RSRNAME(LIN012)
          /* Create controller description for CHICAGO to

```

```

                                NEWYORK */
    CRTCTLAPPC CTLD(NEWYORK) LINKTYPE(*SDLC) LINE(NEWYORK)
                                RMTNETID(APPN) RMTCPNAME(NEWYORK)
                                STNADR(01) NODETYPE(*ENDNODE)
/*****
/*                                CHICAGO TO LOSANGEL                                */
/*****
/* Create line description for CHICAGO to LOSANGEL */
    CRTLINS DLC LIND(LOSANGEL) RSRCPNAME(LIN031)
/* Create controller description for CHICAGO to
                                LOSANGEL */
    CRTCTLAPPC CTLD(LOSANGEL) LINKTYPE(*SDLC) LINE(LOSANGEL)
                                RMTNETID(APPN) RMTCPNAME(LOSANGEL)
                                STNADR(01) NODETYPE(*ENDNODE)
ENDPGM

```

Change the network attributes (Chicago) in three-system network: The Change Network Attributes (CHGNETA) command sets the attributes for the system within the network. The following attributes are defined for CHICAGO:

LCLNETID(APPN)

Specifies that the name of the local network is APPN. The remote locations (NEWYORK and LOSANGEL in the example, systems A and B in Figure 6 on page 34) must specify this name as the remote network identifier (RMTNETID).

LCLCPNAME(CHICAGO)

Specifies that the name assigned to the local control point is CHICAGO. The remote system specifies this name as the remote control point name (RMTCPNAME) on the CRTCTLAPPC command.

LCLLOCNAME(CHICAGO)

The name of this location is CHICAGO. This name will be used for the device description that is created by the APPN support.

NODETYPE(*NETNODE)

Specifies that the local system (CHICAGO) is a networking node in the APPN network.

Create the line description (Chicago to New York) in three-system network: The line used in this example is an SDLC nonswitched line. The command used to create the line description is CRTLINS DLC. The parameters specified are:

LIND(NEWYORK)

The name assigned to the line description is NEWYORK.

RSRCPNAME(LIN012)

Specifies the physical communications port named LIN012.

Create the controller description (Chicago to New York) in three-system network: Because this is an APPN environment (iSeries system to iSeries system), the controller is an APPC controller, and the CRTCTLAPPC command defines the attributes of the controller. The example command defines the following attributes:

CTLD(NEWYORK)

The name assigned to the controller description is NEWYORK.

LINKTYPE(*SDLC)

Because this controller is attached through an SDLC communications line, the value specified is *SDLC. This value must correspond to the type of line being used as defined by a create line description command.

LINE(NEWYORK)

Specifies the name (NEWYORK) of the line description to which this controller is attached. This value must match a name that is specified by the LIND parameter in a line description.

RMTNETID(APPN)

The name of the network in which the remote control point resides is APPN.

RMTCPNAME(NEWYORK)

Specifies that the remote control-point name (at NEWYORK) is NEWYORK. The name specified here must match the name that is specified at the remote system for the local control-point name. In the example, the LCLCPNAME parameter on the CHGNETA command specifies the name at the remote system (NEWYORK).

STNADR(01)

The address assigned to the remote controller is hex 01.

NODETYPE(*ENDNODE)

Specifies that the remote system (NEWYORK) is an APPN end node.

Create the line description (Chicago to Los Angeles): The line used in this example is an SDLC nonswitched line. The Create Line Description (SDLC) (CRTLINS DLC) is command that is used to create the line. The parameters specified are:

LIND(LOSANGEL)

The name assigned to the line description is LOSANGEL.

RSRCNAME(LIN031)

Specifies the physical communications port named LIN031.

Create the controller description (Chicago to Los Angeles): Because this is an APPN environment (iSeries system to iSeries system), the controller is an APPC controller, and the CRTCTLAPPC command defines the attributes of the controller. The example command defines the following attributes:

CTLD(LOSANGEL)

The name assigned to the controller description is LOSANGEL.

LINKTYPE(*SDLC)

Because this controller is attached through an SDLC communications line, the value specified is *SDLC. This value must correspond to the type of line being used as defined by a create line description command.

LINE(LOSANGEL)

Specifies the name (LOSANGEL) of the line description to which this controller is attached. This value must match a name that is specified by the LIND parameter in a line description.

RMTNETID(APPN)

The name of the network in which the remote control point resides is APPN.

RMTCPNAME(LOSANGEL)

Specifies that the remote control-point name (at LOSANGEL) is LOSANGEL. The name specified here must match the name that is specified at the remote system for the local control-point name. In the example, the LCLCPNAME parameter of the Change Network Attributes (CHGNETA) command specifies the name at the remote system (LOSANGEL).

STNADR(01)

The address assigned to the remote controller is hex 01.

NODETYPE(*ENDNODE)

Specifies that the remote system (LOSANGEL) is an APPN end node.

Example: Two APPN networks with different network IDs linked together

Figure 7 shows two APPN networks that are linked together by network nodes.

- | The network with the LCLNETID of NEWNET is a simple connection of one end node to one network
- | node. Network node B might act as a network server providing routing services for node A. Although
- | there are no other nodes in the NEWNET network, there is a need for nodes A and B to communicate

l with the nodes in network APPN. To accomplish this, network node B is connected to network node
 l NN1 in the APPN network. Node B must have a line description and a controller description created to
 l identify node A, and a line description and a controller description to identify node NN1.

The network with the LCLNETID of APPN is similar to NEWNET; with the exception that NN2 is a network node instead of an end node. In order for NN1 and NN2 to communicate with the nodes in NEWNET, NN1 must have two line descriptions, and two controller descriptions created. These identify both node B and node NN2.

After node B and node NN1 are identified to each other as adjacent nodes, all nodes in either network can communicate through nodes B and NN1.

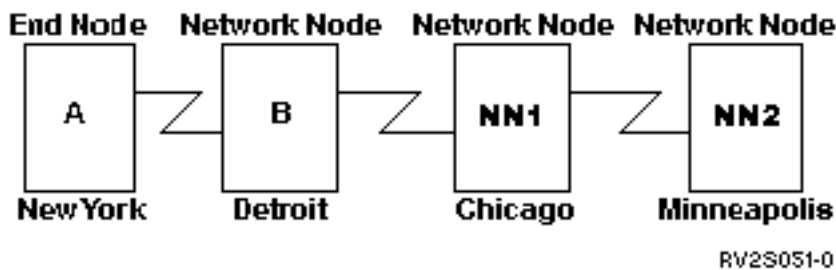

Figure 7. Two APPN networks linked by network nodes

Each list below represents a city within the network in Figure 7 above. See the links in each list to determine the configuration requirements for each system.

New York

- “Example: Configure system: New York” on page 43
- “Change the network attributes (New York) for two APPN networks with different IDs” on page 43
- “Create the line description (New York)” on page 44
- “Create the controller description (New York) for two-system network with different IDs” on page 44

Detroit

- “Example: Configure system B (Detroit)” on page 44
- “Change the network attributes (Detroit)” on page 45
- “Create the line description (Detroit to New York)” on page 45
- “Create the controller description (Detroit to New York)” on page 46
- “Create the line description (Detroit to Chicago)” on page 46
- “Create the controller description (Detroit to Chicago)” on page 46

Chicago

- “Example: Configure system NN1 (Chicago)” on page 47
- “Change the network attributes (Chicago) for two-system APPN network with different IDs” on page 47
- “Create the line description (Chicago to Minneapolis) for two-system APPN network with different IDs” on page 48
- “Create the controller description (Chicago to Minneapolis) for two-system APPN network with different IDs” on page 48
- “Create the line description (Chicago to Detroit)” on page 48
- “Create the controller description (Chicago to Detroit)” on page 49

Minneapolis

- “Example: Configure NN2 (Minneapolis)” on page 49
- “Change the network attributes (Minneapolis) for two networks with different ID’s” on page 50
- “Create the line description (Minneapolis to Chicago)” on page 50
- “Create the controller description (Minneapolis to Chicago)” on page 50

Example: Configure system: New York: The following CL commands are used to define the configuration for the system identified as NEWYORK (system A in Figure 7 on page 42). The examples show these commands as used within a CL program; the configuration can also be performed using the configuration menus.

Note: Read the code disclaimer information for important legal information.

```
/******  
/*  
/* MODULE: NYCINT LIBRARY: PUBSCFGS */  
/*  
/* LANGUAGE: CL */  
/*  
/* FUNCTION: CONFIGURES APPN EN-NN AS FOLLOWS: */  
/*  
/* NEWYORK / _____ \ DETROIT */  
/* \ _____ / */  
/*  
/* (THIS IS NEWYORK TO DETROIT) */  
/*  
/*  
/*  
/*  
/******  
PGM  
/******  
/* NEWYORK TO DETROIT */  
/******  
/* Change network attributes for NEWYORK */  
CHGNETA LCLNETID(NEWNET) LCLCPNAME(NEWYORK)  
LCLLOCNAME(NEWYORK) NODETYPE(*ENDNODE)  
NETSERVER((NEWNET DETROIT))  
/* Create line description for NEWYORK to DETROIT */  
CRTLINS DLC LIND(DETROIT) RSRCPNAME(LIN011)  
/* Create controller description for NEWYORK to  
DETROIT */  
CRTCTLAPPC CTLD(DETROIT) LINKTYPE(*SDLC) LINE(DETROIT)  
RMTNETID(NEWNET) RMTCPNAME(DETROIT)  
STNADR(01) NODETYPE(*NETNODE)  
ENDPGM
```

Change the network attributes (New York) for two APPN networks with different IDs: The Change Network Attributes (CHGNETA) command set the attributes for the system within the network. The following attributes are defined for NEWYORK:

LCLNETID(NEWNET)

Specifies that the name of the local network is NEWNET. The remote location (DETROIT in the example, system B in Figure 7 on page 42), must specify this name as the remote network identifier (RMTNETID) on the CRTCTLAPPC command.

LCLCPNAME(NEWYORK)

Specifies that the name assigned to the local control point is NEWYORK. The remote system specifies this name as the remote control-point name (RMTCPNAME) on the CRTCTLAPPC command.

LCLLOCNAME(NEWYORK)

The default local location name of this location is NEWYORK. This name is used for the device description that is created by the APPN support.

NODETYPE(*ENDNODE)

Specifies that the local system (NEWYORK) is an end node in the NEWNET network.

NETSERVER((NEWNET DETROIT))

Specifies the name of the network node (DETROIT) and the name of the network (NEWNET) that serves this end node. These names are defined at the remote system on the CHGNETA command.

Create the line description (New York): The line used in this example is an SDLC nonswitched line. The command used to create the line is CRTLINS DLC. The parameters specified are:

LIND(DETROIT)

The name assigned to the line description is DETROIT.

RSRCNAME(LIN011)

Specifies the physical communications port named LIN011.

Create the controller description (New York) for two-system network with different IDs: Because this is an APPN environment (iSeries system to iSeries system), the controller is an APPC controller, and the CRTCTLAPPC command defines the attributes of the controller. The example command defines the following attributes:

CTLD(DETROIT)

The name assigned to the controller description is DETROIT.

LINKTYPE(*SDLC)

Because this controller is attached through an SDLC communications line, the value specified is *SDLC. This value must correspond to the type of line being used as defined by a create line description command.

LINE(DETROIT)

Specifies the name (DETROIT) of the line description to which this controller is attached. This value must match a name that is specified by the LIND parameter in a line description.

RMTNETID(NEWNET)

The name of the network in which the remote control point resides is NEWNET.

RMTCPNAME(DETROIT)

Specifies that the remote control-point name is DETROIT. The name specified here must match the name that is specified at the remote system for the local control-point name. In the example, the LCLCPNAME parameter on the CHGNETA command specifies the name at the remote system (DETROIT).

STNADR(01)

The address assigned to the remote controller is hex 01.

NODETYPE(*NETNODE)

Specifies that the remote location (DETROIT) is an APPN networking node.

Example: Configure system B (Detroit): The following CL commands define the configuration for the system that is identified as DETROIT (system B in Figure 7 on page 42). The example shows the commands as used within a CL program; the configuration can also be performed using the configuration menus.

Note: Read the code disclaimer information for important legal information.

```

/*****/
/*
/* MODULE:  DETRINT                LIBRARY:  PUBSCFGS          */
/*
/* LANGUAGE:  CL                    */
/*
/* FUNCTION:  CONFIGURES APPN NETWORK:
/*

```

```

/*
/*      NEWYORK  /-----\  DETROIT  /-----\  CHICAGO      */
/*      \-----/      \-----/      */
/*
/*      (THIS IS DETROIT TO NEWYORK AND CHICAGO)      */
/*
/*
/*
/*
/*****/
PGM
/* Change network attributes for DETROIT */
CHGNETA   LCLNETID(NEWNET) LCLCPNAME(DETROI
          LCLLOCNAME(DETROI) NODETYPE(*NETNODE)
/*****/
/*      DETROIT TO NEWYORK      */
/*****/
/* Create line description for DETROIT to NEWYORK */
CRTLINS DLC LIND(NEWYORK) RSRNAME(LIN012)
/* Create controller description for DETROIT to
          NEWYORK */
CRTCTLAPPC CTLD(NEWYORK) LINKTYPE(*SDLC) LINE(NEWYORK)
          RMTNETID(NEWNET) RMTCPNAME(NEWYORK)
          STNADR(01) NODETYPE(*ENDNODE)
/*****/
/*      DETROIT TO CHICAGO      */
/*****/
/* Create line description for DETROIT to CHICAGO */
CRTLINS DLC LIND(CHICAGO) RSRNAME(LIN031)
/* Create controller description for DETROIT to
          CHICAGO */
CRTCTLAPPC CTLD(CHICAGO) LINKTYPE(*SDLC) LINE(CHICAGO)
          RMTNETID(APPN) RMTCPNAME(CHICAGO)
          STNADR(01) NODETYPE(*NETNODE)
ENDPGM

```

Change the network attributes (Detroit): The Change Network Attributes (CHGNETA) command sets the attributes for the system within the network. The following attributes are defined for DETROIT:

LCLNETID(NEWNET)

Specifies that the name of the local network is NEWNET. The remote locations (NEWYORK and CHICAGO in the example program, systems A and NN1 in Figure 7 on page 42) must specify this name as the remote network identifier (RMTNETID).

LCLCPNAME(DETROI)

Specifies that the name assigned to the local control point is DETROI. The remote system specifies this name as the remote control-point name (RMTCPNAME) on the CRTCTLAPPC command.

LCLLOCNAME(DETROI)

The name of this location is DETROI. This name is used for the device description that is created by the APPN support.

NODETYPE(*NETNODE)

Specifies that the local system (DETROI) is a networking node in the NEWNET network.

Create the line description (Detroit to New York): The line used in this example is an SDLC nonswitched line. The command used to create the line description is CRTLINS DLC. The parameters specified are:

LIND(NEWYORK)

The name assigned to the line description is NEWYORK.

RSRNAME(LIN012)

Specifies the physical communications port named LIN012.

Create the controller description (Detroit to New York): Because this is an APPN environment (iSeries system to iSeries system), the controller is an APPC controller, and the CRTCTLAPPC command defines the attributes of the controller. The example command defines the following attributes:

CTLD(NEWYORK)

The name assigned to the controller description is NEWYORK.

LINKTYPE(*SDLC)

Because this controller is attached through an SDLC communications line, the value specified is *SDLC. This value must correspond to the type of line being used as defined by a create line description command.

LINE(NEWYORK)

Specifies the name (NEWYORK) of the line description to which this controller is attached. This value must match a name that is specified by the LIND parameter in a line description.

RMTNETID(NEWNET)

The name of the network in which the remote control point resides is NEWNET.

RMTCPNAME(NEWYORK)

Specifies that the remote control-point name is NEWYORK. The name specified here must match the name that is specified at the remote system for the local control-point name. In the example, the LCLCPNAME parameter on the CHGNETA command specifies the name at the remote system (NEWYORK).

STNADR(01)

The address assigned to the remote controller is hex 01.

NODETYPE(*ENDNODE)

Specifies that the remote system (NEWYORK) is an APPN end node.

Create the line description (Detroit to Chicago): The line used in this example is an SDLC nonswitched line. The Create Line Description (SDLC) (CRTLINS DLC) command is used to create the line. The parameters specified are:

LIND(CHICAGO)

The name assigned to the line description is CHICAGO.

RSRCNAME(LIN031)

Specifies the physical communications port named LIN031.

Create the controller description (Detroit to Chicago): Because this is an APPN environment (iSeries system to iSeries system), the controller is an APPC controller and the CRTCTLAPPC command defines the attributes of the controller. The example command defines the following attributes:

CTLD(CHICAGO)

The name assigned to the controller description is CHICAGO.

LINKTYPE(*SDLC)

Because this controller is attached through an SDLC communications line, the value specified is *SDLC. This value must correspond to the type of line being used as defined by a create line description command.

LINE(CHICAGO)

Specifies the name (CHICAGO) of the line description to which this controller is attached. This value must match a name that is specified by the LIND parameter in a line description.

RMTNETID(APPN)

The name of the network in which the remote control point resides is APPN.

RMTCPNAME(CHICAGO)

Specifies that the remote control-point name is CHICAGO. The name specified here must match the

name that is specified at the remote system for the local control-point name. In the example, the LCLCPNAME parameter of the Change Network Attributes (CHGNETA) command specifies the name at the remote system (CHICAGO).

STNADR(01)

The address assigned to the remote controller is hex 01.

NODETYPE(*NETNODE)

Specifies that the remote system (CHICAGO) is an APPN network node.

Example: Configure system NN1 (Chicago): The following CL commands are used to define the configuration for the system that is identified as CHICAGO (system NN1 in Figure 7 on page 42). The examples show these commands as used within a CL program; the configuration can also be performed using the configuration menus.

Note: Read the code disclaimer information for important legal information.

```

/*****
/*
/* MODULE:  CHICINT                LIBRARY:  PUBSCFGS          */
/*
/* LANGUAGE:  CL                    */
/*
/* FUNCTION:  CONFIGURES APPN NETWORK:                */
/*
/*           THIS IS:  CHICAGO TO MPLS                */
/*                   CHICAGO TO DETROIT              */
/*
/*
/*
/*
/*
/*****
PGM
           /* Change network attributes for CHICAGO */
CHGNETA  LCLNETID(APPN) LCLCPNAME(CHICAGO) +
           LCLLOCNAME(CHICAGO) NODETYPE(*NETNODE)
/*****
/*                   CHICAGO TO MPLS                */
/*****
           /* Create nonswitched line description for CHICAGO to MPLS */
CRTLINS DLC LIND(MPLSL) RSRNAME(LIN021)
           /* Create controller description for CHICAGO to MPLS */
CRTCTLAPPC CTLD(MPLSL) LINKTYPE(*SDLC) LINE(MPLSL) +
           RMTNETID(APPN) RMTCPNAME(MPLS) +
           STNADR(01) NODETYPE(*NETNODE)
/*****
/*                   CHICAGO TO DETROIT              */
/*****
           /* Create nonswitched line description for CHICAGO to
           DETROIT */
CRTLINS DLC LIND(DETROI) RSRNAME(LIN021)
           /* Create controller description for CHICAGO to
           DETROIT */
CRTCTLAPPC CTLD(DETROI) LINKTYPE(*SDLC) LINE(DETROI) +
           RMTNETID(NEWNET) RMTCPNAME(DETROI) +
           STNADR(01) NODETYPE(*NETNODE)
ENDPGM

```

Change the network attributes (Chicago) for two-system APPN network with different IDs: The Change Network Attributes (CHGNETA) command is used to set the attributes for the system within the network. The following attributes are defined for the CHICAGO system.

LCLNETID(APPN)

The name of the local network is APPN. The remote system (MPLS in the example program, NN2 in Figure 7 on page 42) must specify this name as the remote network identifier (RMTNETID) on the CRTCTLAPPC command.

LCLCPNAME(CHICAGO)

The name assigned to the local control point is CHICAGO. The remote systems specify this name as the remote control-point name (RMTCPNAME) on the CRTCTLAPPC command.

LCLLOCNAME(CHICAGO)

The default local location name is CHICAGO. This name is used for the device description that is created by the APPN support.

NODETYPE(*NETNODE)

The local system (CHICAGO) is an APPN network node.

Create the line description (Chicago to Minneapolis) for two-system APPN network with different IDs: The line used in this example is an SDLC nonswitched line. The command used to create the line is CRTLINS DLC. The parameters specified are:

LIND(MPLSL)

The name assigned to the line description is MPLSL.

RSRCNAME(LIN021)

The physical communications port named LIN021 is defined.

Create the controller description (Chicago to Minneapolis) for two-system APPN network with different IDs: Because this is an APPN environment (iSeries system to iSeries system), the controller is an APPC controller, and the CRTCTLAPPC command is used to define the attributes of the controller. The example command defines the following attributes:

CTLD(MPLSL)

The name assigned to the controller description is MPLSL.

LINKTYPE(*SDLC)

Because this controller is attached through an SDLC communications line, the value specified is *SDLC. This value must correspond to the type of line that is defined by a create line description command.

LINE(MPLSL)

The name of the line description to which this controller is attached is MPLSL. This value must match a name that is specified by the LIND parameter in a line description.

RMTNETID(APPN)

The name of the network in which the remote control point resides is APPN.

RMTCPNAME(MPLS)

The remote control-point name is MPLS. The name specified here must match the name that is specified at the remote system for the local control-point name. In the example, the name is specified at the remote system (MPLS) by the LCLCPNAME parameter on the Change Network Attributes (CHGNETA) command.

STNADR(01)

The address assigned to the remote controller is hex 01.

NODETYPE(*NETNODE)

The remote system (MPLS) is an APPN network node.

Create the line description (Chicago to Detroit): The line used in this example is an SDLC nonswitched line. The command used to create the line is CRTLINS DLC. The parameters specified are:

LIND(DETROI T)

The name assigned to the line description is DETROI T.

RSRCNAME(LIN021)

The physical communications port named LIN021 is defined.

Create the controller description (Chicago to Detroit): Because this is an APPN environment (iSeries system to iSeries system), the controller is an APPC controller, and the CRTCTLAPPC command is used to define the attributes of the controller. The example command defines the following attributes:

CTLD(DETROIIT)

The name assigned to the controller description is DETROIIT.

LINKTYPE(*SDLC)

Because this controller is attached through an SDLC communications line, the value specified is *SDLC. This value must correspond to the type of line that is defined by a create line description command.

LINE(DETROIIT)

The name of the line description to which this controller is attached is DETROIIT. This value must match a name that is specified by the LIND parameter in a line description.

RMTNETID(NEWNET)

The name of the network in which the remote control point resides is NEWNET.

RMTCPNAME(DETROIIT)

The remote control-point name is DETROIIT. The name specified here must match the name that is specified at the remote system for the local control-point name. In the example, the name is specified at the remote system (DETROIIT) by the LCLCPNAME parameter on the Change Network Attributes (CHGNETA) command.

STNADR(01)

The address assigned to the remote controller is hex 01.

NODETYPE(*NETNODE)

The remote system (DETROIIT) is an APPN network node.

Example: Configure NN2 (Minneapolis): The following example program shows the CL commands used to define the configuration for the system that is identified as MPLS (NN2 in Figure 7 on page 42). The example shows these commands used within a CL program; the configuration can also be performed using the configuration menus.

Note: Read the code disclaimer information for important legal information.

```
/* **** */
/*
/* MODULE: MPLSINT LIBRARY: PUBSCFGS */
/*
/* LANGUAGE: CL */
/*
/* FUNCTION: CONFIGURES APPN NETWORK: */
/*
/* THIS IS: MPLS TO CHICAGO (nonswitched) */
/*
/*
/* **** */
PGM
    /* Change network attributes for MPLS */
    CHGNETA LCLNETID(APPN) LCLCPNAME(MPLS) +
            LCLLOCNAME(MPLS) NODETYPE(*NETNODE)
/* **** */
/* MPLS TO CHICAGO */
/* **** */
    /* Create line description for MPLS to CHICAGO */
    CRTLINS DLC LIND(CHICAGO) RSRCNAME(LIN022)
    /* Create controller description for MPLS to CHICAGO */
```

```
CRTCTLAPPC CTLD(CHICAGO) LINKTYPE(*SDLC) LINE(CHICAGO) +
          RMTNETID(APPN) RMTCPNAME(CHICAGO) +
          STNADR(01) NODETYPE(*NETNODE)
```

ENDPGM

Change the network attributes (Minneapolis) for two networks with different ID's: The Change Network Attributes (CHGNETA) command is used to set the attributes for the system within the network. The following attributes are defined for the MPLS system, and these attributes apply to all connections in the network for this network node:

LCLNETID(APPN)

The name of the local network is APPN. The remote systems (CHICAGO in the example program, NN1 in Figure 7 on page 42) must specify this name as the remote network identifier (RMTNETID) on the CRTCTLAPPC command.

LCLCPNAME(MPLS)

The name assigned to the local control point is MPLS. The remote system specifies this name as the remote control-point name (RMTCPNAME) on the CRTCTLAPPC command.

LCLLOCNAME(MPLS)

The default local location name is MPLS. This name is used for the device description that is created by the APPN support.

NODETYPE(*NETNODE)

The local system (MPLS) is an APPN network node.

Create the line description (Minneapolis to Chicago): The line used in this example is an SDLC nonswitched line. The command used to create the line is CRTLINS DLC. The parameters specified are:

LIND(CHICAGO)

The name assigned to the line description is CHICAGO.

RSRCNAME(LIN022)

The physical communications port named LIN022.

Create the controller description (Minneapolis to Chicago): Because this is an APPN environment (iSeries system to iSeries system), the controller is an APPC controller, and the CRTCTLAPPC command is used to define the attributes of the controller. The example command defines the following attributes:

CTLD(CHICAGO)

The name assigned to the controller description is CHICAGO.

LINKTYPE(*SDLC)

Because this controller is attached through an SDLC communications line, the value specified is *SDLC. This value must correspond to the type of line that is defined by a create line description command.

LINE(CHICAGO)

The name of the line description to which this controller is attached is CHICAGO. This value must match a name that is specified by the LIND parameter in a line description.

RMTNETID(APPN)

The name of the network in which the remote control point resides is APPN.

RMTCPNAME(CHICAGO)

The remote control-point name is CHICAGO. The name specified here must match the name that is specified at the remote system for the local control-point name. In the example, the name is specified at the remote system (CHICAGO) by the LCLCPNAME parameter on the Change Network Attributes (CHGNETA) command.

STNADR(01)

The address assigned to the remote controller is hex 01.

NODETYPE(*NETNODE)

The remote system (CHICAGO) is an APPN network node.

Example: Multiple iSeries systems using APPN

The following sections describe configuration for the network that is shown in Figure 8. In this network, seven iSeries systems are configured to communicate, using the APPN functions. Network attributes, line descriptions, APPC controller descriptions, and APPC device descriptions are created, either automatically or manually, to set up this network.

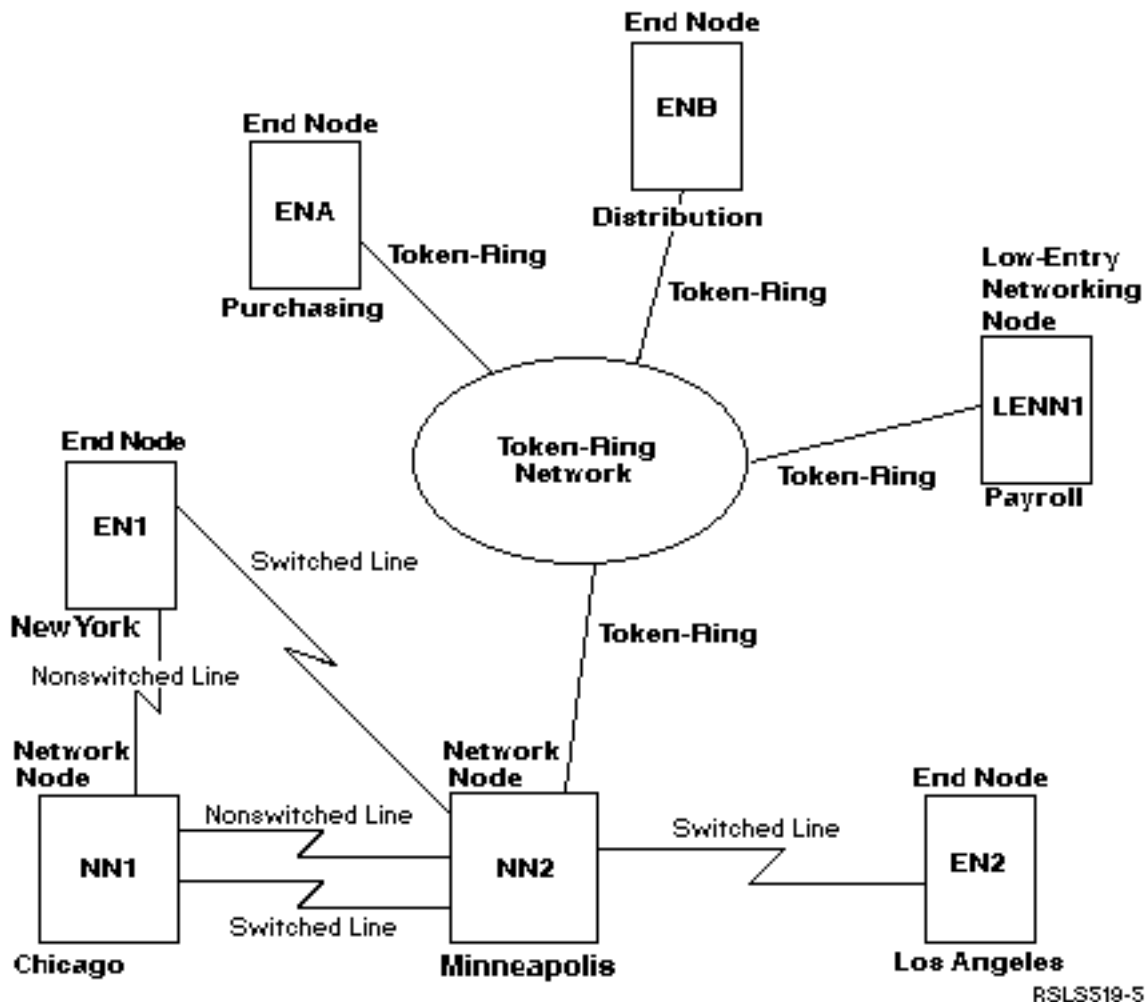

Figure 8. Multiple iSeries systems using APPN

Each list below represents a city within the network in Figure 8 above. See the links in each list to determine the configuration requirements for each system.

New York

- “Example: Configure end node 1 (New York)” on page 53
- “Change the network attributes (New York) in multiple-system network” on page 54
- “Create the remote location configuration list (New York)” on page 54
- “Create the line description (New York to Chicago)” on page 54
- “Create the controller description (New York to Chicago)” on page 54
- “Create the line description (New York to Minneapolis)” on page 55
- “Create the controller description (New York to Minneapolis)” on page 55

Chicago

- “Example: Configure network node 1 (Chicago)” on page 56
- “Change the network attributes (Chicago) in multiple-system network” on page 57
- “Create the line description (Chicago to New York)” on page 57
- “Create the controller description (Chicago to New York)” on page 58
- “Create the line description (Chicago to Minneapolis) in multiple-system network” on page 58
- “Create the controller description (Chicago to Minneapolis) in multiple-system network” on page 58
- “Create line description B (Chicago to Minneapolis) in multiple-system network” on page 59
- “Create controller description B (Chicago to Minneapolis) in multiple-system network” on page 59

Minneapolis

- “Example: Configure network node 2 (Minneapolis) in multiple-system network” on page 60
- “Change the network attributes (Minneapolis) in multiple-system network” on page 61
- “Create the line description (Minneapolis to New York, switched)” on page 62
- “Create the controller description (Minneapolis to New York, switched)” on page 62
- “Create the line description A (Minneapolis to Chicago)” on page 63
- “Create the controller description (Minneapolis to Chicago, nonswitched)” on page 63
- “Create the line description B (Minneapolis to Chicago)” on page 63
- “Create the controller description (Minneapolis to Chicago, switched)” on page 64
- “Create the line description (Minneapolis to Los Angeles, switched)” on page 65
- “Create the controller description (Minneapolis to Los Angeles, switched)” on page 65
- “Create the line description (Minneapolis to token-ring network)” on page 66
- “Create the controller description (Minneapolis to Purchasing, token-ring network)” on page 66
- “Create the controller description (Minneapolis to Distribution, token-ring network)” on page 67
- “Create the controller description (Minneapolis to Payroll, token-ring network)” on page 67

Los Angeles

- “Example: Configure end node 2 (Los Angeles)” on page 68
- “Change the network attributes (Los Angeles) in multiple-system network” on page 69
- “Create the line description (Los Angeles to Minneapolis)” on page 69
- “Create the controller description (Los Angeles to Minneapolis)” on page 69

Purchasing

- “Example: Configure end node A (Purchasing)” on page 70
- “Change the network attributes (Purchasing)” on page 71
- “Create the remote location configuration list (Purchasing)” on page 71
- “Create the line description (Purchasing to token-ring network)” on page 72
- “Create the controller description (Purchasing to Minneapolis, token-ring network)” on page 72
- “Create the controller description (Purchasing to Distribution, token-ring network)” on page 73

Distribution

- “Example: Configure end node B (Distribution)” on page 73
- “Change the network attributes (Distribution)” on page 74
- “Create the line description (Distribution to token-ring network)” on page 74
- “Create the controller description (Distribution to Minneapolis, token-ring network)” on page 75
- “Create the controller description (Distribution to Purchasing, token-ring network)” on page 75

Payroll

- “Example: Configure low entry networking end node 1 (Payroll)” on page 76
- “Create the line description (Payroll to token-ring network)” on page 77
- “Create the controller description (Payroll to token-ring network)” on page 77
- “Create the APPC device (Payroll to New York)” on page 78
- “Create the APPC device (Payroll to Los Angeles)” on page 78
- “Create the APPC device (Payroll to Minneapolis)” on page 79

Example: Configure end node 1 (New York): The following CL commands are used to define the configuration for the system that is identified as NEWYORK. The example shows the commands used within a CL program; the configuration can also be performed using the configuration menus.

Note: Read the code disclaimer information for important legal information.

```
/******  
/*  
/* MODULE: NEWYORK LIBRARY: PUBSCFGS */  
/*  
/* LANGUAGE: CL */  
/*  
/* FUNCTION: CONFIGURES APPN NETWORK: */  
/*  
/* THIS IS: NEWYORK TO CHICAGO (nonswitched) */  
/* NEWYORK TO MPLS (switched) */  
/*  
/*  
/*  
/******  
PGM  
/******  
/* NEWYORK TO CHICAGO (nonswitched) */  
/******  
/* Change network attributes for NEWYORK */  
CHGNETA LCLNETID(APPN) LCLCPNAME(NEWYORK)  
LCLLOCNAME(NEWYORK) NODETYPE(*ENDNODE)  
NETSERVER((APPN CHICAGO) (APPN MPLS))  
/* Create remote configuration list for NEWYORK to  
Los Angeles */  
CRTCFGL TYPE(*APPNRM) APPNRMTE((LOSANGEL APPN  
NEWYORK LOSANGEL APPN 3BD29F *YES *NO *NO *NO  
'RMT LOC of NEWYORK'))  
/* Create nonswitched line description for NEWYORK to */  
CHICAGO CRTLINS DLC LIND(CHICAGOL) RSRNAME(LIN011)  
/* Create controller description for NEWYORK to  
CHICAGO */  
CRTCTLAPPC CTLD(CHICAGOL) LINKTYPE(*SDLC) LINE(CHICAGOL)  
RMTNETID(APPN) RMTCPNAME(CHICAGO)  
STNADR(01) NODETYPE(*NETNODE)  
/******  
/* NEWYORK TO MPLS (switched) */  
/******  
/* Create switched line description NEWYORK to MPLS */  
CRTLINS DLC LIND(MPLSS) RSRNAME(LIN012) CNN(*SWTP)  
AUTOANS(*NO) STNADR(01) COSTCNN(128)  
COSTBYTE(128)  
/* Create controller description for NEWYORK to MPLS */  
CRTCTLAPPC CTLD(MPLSS) LINKTYPE(*SDLC) SWITCHED(*YES)  
SWTLINLST(MPLSS) RMTNETID(APPN)  
RMTCPNAME(MPLS) INLCNN(*ANS)  
CNNNBR(6125551234) STNADR(01)  
CPSSN(*NO) NODETYPE(*NETNODE)  
ENDPGM
```

Change the network attributes (New York) in multiple-system network: The Change Network Attributes (CHGNETA) command is used to set the attributes for the system within the network. The following attributes are defined for NEWYORK, and these attributes apply to all connections in the network for this end node:

LCLNETID(APPN)

Specifies that the name of the local network is APPN. The remote location (MINNEAPOLIS in the example, NN2 in the Figure 8 on page 51) must specify this name as the remote network identifier (RMTNETID) on the CRTCTLAPPC command.

LCLCPNAME(NEWYORK)

Specifies that the name assigned to the local control point is NEWYORK. The remote systems specify this name as the remote control point name (RMTCPNAME) on the CRTCTLAPPC command.

LCLLOCNAME(NEWYORK)

The default local location name is NEWYORK. This name will be used for the device description that is created by the APPN support.

NODETYPE(*ENDNODE)

Specifies that the local system (NEWYORK) is an APPN end node.

NETSERVER((APPN CHICAGO)

Specifies that network nodes CHICAGO (NN1) and MPLS (NN2) are both potential network node servers for this end point. Both network node servers are in the same (APPN) network.

Create the remote location configuration list (New York): The Create Configuration List (CRTCFGL) command is also used to define the remote locations with special characteristics to the APPN support. In this example, location security is being used, and the following is defined at NEWYORK:

TYPE(*APPNRMT)

Specifies that the entries being defined are remote locations.

APPNRMTE((LOSANGEL APPN NEWYORK LOSANGEL APPN 3BD29F *YES *NO *NO *NO 'RMT LOC of NEWYORK')

Specifies the remote location with which the local location can be paired.

- The remote location name is LOSANGEL
- The remote network ID is APPN
- The associated local location name is NEWYORK
- The remote control-point name is LOSANGEL
- The remote control point network ID is also APPN
- The password is 3BD29F
- It is a secure location
- It is not a single session location. The last two entries, locally controlled sessions and pre-established sessions, are *NO because this is not a single session location.

Create the line description (New York to Chicago): The line used in this example is an SDLC nonswitched line. The command used to create the line is CRTLINS DLC. The parameters specified are:

LIND(CHICAGOL)

The name assigned to the line description is CHICAGOL.

RSRCNAME(LIN011)

Specifies that the physical communications port named LIN011 is being defined.

Create the controller description (New York to Chicago): Because this is an APPN environment (iSeries system to iSeries system), the controller is an APPC controller and the CRTCTLAPPC command is used to define the attributes of the controller. The example command defines the following attributes:

CTLD(CHICAGOL)

The name assigned to the controller description is CHICAGOL.

LINKTYPE(*SDLC)

Because this controller is attached through an SDLC communications line, the value specified is *SDLC. This value must correspond to the type of line being used as defined by a create line description command.

LINE(CHICAGOL)

Specifies the name (CHICAGOL) of the line description to which this controller is attached. This value must match a name that is specified by the LIND parameter in a line description.

RMTNETID(APPN)

The name of the network in which the remote control point resides is APPN.

RMTCPPNAME(CHICAGO)

Specifies that the remote control-point name is CHICAGO. The name specified here must match the name that is specified at the remote system for the local control-point name. In the example, the name is specified at the remote system (CHICAGO) by the LCLCPNAME parameter of the Change Network Attributes (CHGNETA) command.

STNADR(01)

The address assigned to the remote controller is hex 01.

NODETYPE(*NETNODE)

Specifies that the remote location (CHICAGO) is an APPN networking node.

Create the line description (New York to Minneapolis): The line used in this example is an SDLC switched line. The command used to create the line is CRTLINSDLC. The parameters specified are:

LIND(MPLSS)

The name assigned to the line description is MPLSS.

RSRCNAME(LIN012)

Specifies that the physical communications port named LIN012 is being defined.

CNN(*SWTPP)

Specifies that this is a switched line connection.

AUTOANS(*NO)

Specifies that this system will not automatically answer an incoming call.

STNADR(01)

The address assigned to the remote controller is hex 01.

COSTCNN(128)

The relative cost of being connected to this line is 128, with 0 being the lowest cost and 255 the highest. The class of service use this for route selection.

COSTBYTE(128)

The relative cost of transferring a byte of data across this line is 128, with 0 being the lowest cost and 255 the highest. This is used for route selection by the class of service.

Create the controller description (New York to Minneapolis): Because this is an APPN environment (iSeries system to iSeries system), the controller is an APPC controller and the CRTCTLAPPC command is used to define the attributes of the controller. The following attributes are defined by the example command:

CTLD(MPLSS)

The name assigned to the controller description is MPLSS.

LINKTYPE(*SDLC)

Because this controller is attached through an SDLC communications line, the value specified is *SDLC. This value must correspond to the type of line being used as defined by a create line description command.

SWITCHED(*YES)

Specifies that this controller is attached to a switched SDLC line.

SWTLINLST(MPLSS)

Specifies the name (MPLSS) of the line description (for switched lines) that this controller can be attached to. In the example, there is only one line (MPLSS). This value must match a name that is specified by the LIND parameter in a line description.

RMTNETID(APPN)

The name of the network in which the remote location resides is APPN.

RMTCPNAME(MPLS)

Specifies that the remote control-point name is MPLS. The name specified here must match the name that is specified at the remote system for the local control-point name. In the example, the name is specified at the remote system (MPLSS) by the LCLCPNAME parameter of the Change Network Attributes (CHGNETA) command.

INLCNN(*ANS)

Specifies that the initial connection is made by the iSeries system answering an incoming call.

CNNNBR(6125551234)

The connection (telephone) number for the remote controller is 6125551234.

STNADR(01)

The address assigned to the remote controller is hex 01.

CPSSN(*NO)

Control point sessions are not supported with this node.

NODETYPE(*NETNODE)

Specifies that the remote location (MPLS) is an APPN networking node.

Example: Configure network node 1 (Chicago): The following CL commands are used to define the configuration for the system named as CHICAGO (NN1). The example shows the commands as used within a CL program; the configuration can also be done using the configuration menus.

Note: Read the code disclaimer information for important legal information.

```
/******  
/*  
/* MODULE: CHICAGO LIBRARY: PUBSCFGS */  
/*  
/* LANGUAGE: CL */  
/*  
/* FUNCTION: CONFIGURES APPN NETWORK: */  
/*  
/* THIS IS: CHICAGO TO NEWYORK (nonswitched) */  
/* CHICAGO TO MPLS (nonswitched) */  
/* CHICAGO TO MPLS (switched) */  
/*  
/*  
/*  
/*  
/******  
PGM  
/* Change network attributes for CHICAGO */  
CHGNETA LCLNETID(APPN) LCLCPNAME(CHICAGO)  
LCLLOCNAME(CHICAGO) NODETYPE(*NETNODE)  
/******  
/* CHICAGO TO NEWYORK */
```

```

/*****/
/* Create line description for CHICAGO to NEWYORK */
CRTLINS DLC LIND(NEWYORK) RSRNAME(LIN012)
/* Create controller description for CHICAGO to
NEWYORK */
CRTCTLAPPC CTLD(NEWYORK) LINKTYPE(*SDLC) LINE(NEWYORK)
RMTNETID(APPN) RMTCPNAME(NEWYORK)
STNADR(01) NODETYPE(*ENDNODE)
/*****/
/*
CHICAGO TO MPLS (nonswitched) */
/*****/
/* Create nonswitched line description for CHICAGO to MPLS */
CRTLINS DLC LIND(MPLSL) RSRNAME(LIN021)
/* Create controller description for CHICAGO to MPLS */
CRTCTLAPPC CTLD(MPLSL) LINKTYPE(*SDLC) LINE(MPLSL)
RMTNETID(APPN) RMTCPNAME(MPLS)
STNADR(01) NODETYPE(*NETNODE)
/*****/
/*
CHICAGO TO MPLS (switched) */
/*****/
/* Create switched line description for CHICAGO to MPLS */
CRTLINS DLC LIND(MPLSS) RSRNAME(LIN022) CNN(*SWTPP)
STNADR(01) AUTOANS(*NO) COSTCNN(128)
COSTBYTE(128)
/* Create controller description for CHICAGO to MPLS */
CRTCTLAPPC CTLD(MPLSS) LINKTYPE(*SDLC) SWITCHED(*YES)
SWTLINLST(MPLSS) RMTNETID(APPN)
RMTCPNAME(MPLS) INLCNN(*DIAL)
CNNNBR(6125551111) STNADR(01)
TMSGRPNBR(3) NODETYPE(*NETNODE)

ENDPGM

```

Change the network attributes (Chicago) in multiple-system network: The Change Network Attributes (CHGNETA) command is used to set the attributes for the system within the network. The following attributes are defined for CHICAGO and these attributes apply to all connections in the network for this network node.

LCLNETID(APPN)

Specifies that the name of the local network is APPN. The remote location (MPLS in the example, NN2 in the figure, and NEWYORK, EN1 in the figure) must specify this name as the remote network identifier (RMTNETID) on the CRTCTLAPPC command.

LCLCPNAME(CHICAGO)

Specifies that the name assigned to the local control point is CHICAGO. The remote systems specify this name as the remote control point name (RMTCPNAME) on the CRTCTLAPPC command.

LCLLOCNAME(CHICAGO)

The default local location name is CHICAGO. This name will be used for the device description that is created by the APPN support.

NODETYPE(*NETNODE)

Specifies that the local system (CHICAGO) is an APPN network node.

Create the line description (Chicago to New York): The line used in this example is an SDLC nonswitched line. The command used to create the line is CRTLINS DLC. The parameters specified are:

LIND(NEWYORK)

The name assigned to the line description is NEWYORK.

RSRNAME(LIN012)

Specifies that the physical communications port named LIN012 is being defined.

Create the controller description (Chicago to New York): Because this is an APPN environment (iSeries system to iSeries system), the controller is an APPC controller and the CRTCTLAPPC command is used to define the attributes of the controller. The following attributes are defined by the example command:

CTLD(NEWYORK)

The name assigned to the controller description is NEWYORK.

LINKTYPE(*SDLC)

Because this controller is attached through an SDLC communications line, the value specified is *SDLC. This value must correspond to the type of line being used as defined by a create line description command.

LINE(NEWYORK)

Specifies the name (NEWYORK) of the line description to which this controller is attached. This value must match a name that is specified by the LIND parameter in a line description.

RMTNETID(APPN)

The name of the network in which the remote control point resides is APPN.

RMTCPPNAME(NEWYORK)

Specifies that the remote control-point name is NEWYORK. The name specified here must match the name that is specified at the remote system for the local control-point name. In the example, the name is specified at the remote system (NEWYORK) by the LCLCPNAME parameter of the Change Network Attributes (CHGNETA) command.

STNADR(01)

The address assigned to the remote controller is hex 01.

NODETYPE(*ENDNODE)

Specifies that the remote location (NEWYORK) is an APPN end node.

Create the line description (Chicago to Minneapolis) in multiple-system network: The line used in this example is an SDLC nonswitched line. The command used to create the line is CRTLINS DLC. The parameters specified are:

LIND(MPLSL)

The name assigned to the line description is MPLSL.

RSRCNAME(LIN021)

Specifies that the physical communications port named LIN021 is being defined.

Create the controller description (Chicago to Minneapolis) in multiple-system network: Because this is an APPN environment (iSeries system to iSeries system), the controller is an APPC controller and the CRTCTLAPPC command is used to define the attributes of the controller. The following attributes are defined by the example command:

CTLD(MPLSL)

The name assigned to the controller description is MPLSL.

LINKTYPE(*SDLC)

Because this controller is attached through an SDLC communications line, the value specified is *SDLC. This value must correspond to the type of line being used as defined by a create line description command.

LINE(MPLSL)

Specifies the name (MPLSL) of the line description to which this controller is attached. This value must match a name that is specified by the LIND parameter in a line description.

RMTNETID(APPN)

The name of the network in which the remote control point resides is APPN.

RMTCPPNAME(MPLS)

Specifies that the remote control-point name is MPLS. The name specified here must match the name

that is specified at the remote system for the local control-point name. In the example, the name is specified at the remote system (NEWYORK) by the LCLCPNAME parameter on the Change Network Attributes (CHGNETA) command.

STNADR(01)

The address assigned to the remote controller is hex 01.

NODETYPE(*NETNODE)

Specifies that the remote location (MPLS) is an APPN networking node.

Create line description B (Chicago to Minneapolis) in multiple-system network: The line used in this example is an SDLC switched line. The command used to create the line is CRTLINSDLC. The parameters specified are:

LIND(MPLSS)

The name assigned to the line description is MPLSS.

RSRCNAME(LIN022)

Specifies that the physical communications port named LIN022 is being defined.

CNN(*SWTPP)

Specifies that this is a switched line connection.

STNADR(01)

The address assigned to the local system is hex 01.

AUTOANS(*NO)

Specifies that this system will not automatically answer an incoming call.

COSTCNN(128)

The relative cost of being connected to this line is 128, with 0 being the lowest cost and 255 the highest. The class of service use this for route selection.

COSTBYTE(128)

The relative cost of transferring a byte of data across this line is 128, with 0 being the lowest cost and 255 the highest. This is used for route selection by the class of service.

Create controller description B (Chicago to Minneapolis) in multiple-system network: Because this is an APPN environment (iSeries system to iSeries system), the controller is an APPC controller and the CRTCTLAPPC command is used to define the attributes of the controller. The following attributes are defined by the example command:

CTLD(MPLSS)

The name assigned to the controller description is MPLSS.

LINKTYPE(*SDLC)

Because this controller is attached through an SDLC communications line, the value specified is *SDLC. This value must correspond to the type of line being used as defined by a create line description command.

SWITCHED(*YES)

Specifies that this controller is attached to a switched SDLC line.

SWTLINLST(MPLSS)

Specifies the name (MPLSS) of the line description (for switched lines) that this controller can be attached to. In the example, there is only one line (MPLSS). This value must match a name that is specified by the LIND parameter in a line description.

RMTNETID(APPN)

The name of the network in which the remote control point resides is APPN.

RMTCPNAME(MPLS)

Specifies that the remote control-point name is MPLS. The name specified here must match the name

that is specified at the remote system for the local control-point name. In the example, the name is specified at the remote system by the LCLCPNAME parameter on the CHGNETA (Change Network Attributes) command.

INLCNN(*DIAL)

Specifies that the initial connection is made by the iSeries system either answering an incoming call or placing a call.

CNNNBR(6125551111)

The connection (telephone) number for the remote controller is 6125551111.

STNADR(01)

The address assigned to the remote controller is hex 01.

TMSGRPNBR(3)

Specifies the value (3) is to be used by the APPN support for transmission group negotiation with the remote system.

The remote system must specify the same value for the transmission group.

NODETYPE(*NETNODE)

Specifies that the remote location (MPLS) is an APPN networking node.

Example: Configure network node 2 (Minneapolis) in multiple-system network: The following CL commands are used to define the configuration for the system that is identified as MPLS (NN2 in Figure 8 on page 51). The example shows these commands as used within a CL program; the configuration can also be performed using the configuration menus.

Note: Read the code disclaimer information for important legal information.

```

/*****/
/*
/* MODULE:  MPLS                LIBRARY:  PUBSCFGS          */
/*
/* LANGUAGE:  CL                */
/*
/* FUNCTION:  CONFIGURES APPN NETWORK:                    */
/*
/*           THIS IS: MPLS TO NEWYORK   (switched)        */
/*           MPLS TO CHICAGO   (nonswitched)              */
/*           MPLS TO CHICAGO   (switched)                 */
/*           MPLS TO LOSANGEL  (switched)                 */
/*           MPLS TO PURCH     (LAN)                      */
/*           MPLS TO DISTRIB   (LAN)                      */
/*           MPLS TO PAYROLL   (LAN)                      */
/*
/*
/*
/*****/
PGM

      /* Change network attributes for MPLS */
      CHGNETA  LCLNETID(APPN) LCLCPNAME(MPLS)
              LCLLOCNAME(MPLS) NODETYPE(*NETNODE)
/*****/
/*
/*           MPLS TO NEWYORK (switched) */
/*****/
      /* Create switched line description for MPLS to NEWYORK */
      CRTLINS DLC LIND(NEWYORK) RSRNAME(LIN021) CNN(*SWTPP)
              AUTOANS(*NO) STNADR(01) COSTCNN(128)
              COSTBYTE(128)
      /* Create controller description for MPLS to NEWYORK */
      CRTCTLAPPC CTLD(NEWYORK) LINKTYPE(*SDLC) SWITCHED(*YES)
              SWTLINLST(NEWYORK) RMTNETID(APPN)
              RMTCPNAME(NEWYORK) INLCNN(*DIAL)
              CNNNBR(2125551234) STNADR(01)
              NODETYPE(*ENDNODE) CPSSN(*NO)
/*****/

```

```

/*                               MPLS TO CHICAGO (nonswitched)          */
/*****/
/* Create line description for MPLS to CHICAGO */
CRTLINS DLC LIND(CHICAGOL) RSRNAME(LIN022)
/* Create controller description for MPLS to CHICAGO */
CRTCTLAPPC CTLD(CHICAGOL) LINKTYPE(*SDLC) LINE(CHICAGOL)
RMTNETID(APPN) RMTCPNAME(CHICAGO)
STNADR(01) NODETYPE(*NETNODE)
/*****/
/*                               MPLS TO CHICAGO (switched)          */
/*****/
/* Create switched line description for MPLS to CHICAGO */
CRTLINS DLC LIND(CHICAGOS) RSRNAME(LIN031) CNN(*SWTPP)
AUTOANS(*NO) STNADR(01) COSTCNN(128)
COSTBYTE(128)
/* Create controller description for MPLS TO CHICAGO */
CRTCTLAPPC CTLD(CHICAGOS) LINKTYPE(*SDLC) SWITCHED(*YES)
SWTLINLST(CHICAGOS) RMTNETID(APPN)
RMTCPNAME(CHICAGO) INLCNN(*ANS)
CNNNBR(3125551111) STNADR(01) TMSGRPNBR(3)
NODETYPE(*NETNODE)

/*****/
/*                               MPLS TO LOSANGEL (switched)        */
/*****/
/* Create switched line description for MPLS TO LOSANGEL*/
CRTLINS DLC LIND(LOSANGEL) RSRNAME(LIN032) CNN(*SWTPP)
AUTOANS(*NO) STNADR(01) COSTCNN(128)
COSTBYTE(128)
/* Create controller description for MPLS TO LOSANGEL */
CRTCTLAPPC CTLD(LOSANGEL) LINKTYPE(*SDLC) SWITCHED(*YES)
SWTLINLST(LOSANGEL) RMTNETID(APPN)
RMTCPNAME(LOSANGEL) INLCNN(*DIAL)
CNNNBR(2135553333) STNADR(01) CPSSN(*NO)
/*****/
/*                               MPLS TO LAN (LAN)                  */
/*****/
/* Create LAN line description for MPLS to LAN */
CRTLINTRN LIND(MPLSTRN) RSRNAME(LIN011)
ADPTADR(400000000002)
/* Create controller description for MPLS to PURCH */
CRTCTLAPPC CTLD(PURCH) LINKTYPE(*LAN) SWITCHED(*YES)
SWTLINLST(MPLSTRN) RMTNETID(APPN)
RMTCPNAME(PURCH) ADPTADR(400000000003)
MINSWTSTS(*VRYON) SWTDSC(*NO)
/* Create controller description for MPLS to DISTRIB */
CRTCTLAPPC CTLD(DISTRIB) LINKTYPE(*LAN) SWITCHED(*YES)
SWTLINLST(MPLSTRN) RMTNETID(APPN)
RMTCPNAME(DISTRIB) ADPTADR(400000000004)
MINSWTSTS(*VRYON) SWTDSC(*NO)
/* Create controller description for MPLS to PAYROLL */
CRTCTLAPPC CTLD(PAYROLL) LINKTYPE(*LAN) SWITCHED(*YES)
SWTLINLST(MPLSTRN) ADPTADR(400000000005)
RMTNETID(*NONE) RMTCPNAME(PAYROLL)
NODETYPE(*LENODE)

```

ENDPGM

Change the network attributes (Minneapolis) in multiple-system network: The Change Network Attributes (CHGNETA) command is used to set the attributes for the system within the network. The following attributes are defined for MPLS and these attributes apply to all connections in the network for this network node:

LCLNETID(APPN)

Specifies that the name of the local network is APPN. The remote locations (CHICAGO in the example, NN1 in the figure, LOSANGEL in the example, EN1 in figure, NEWYORK, EN1 in the

figure), and all systems (PURCH, DISTRIB, PAYROLL) on the token-ring local area network, must specify this name as the remote network identifier (RMTNETID) on the CRTCTLAPPC command.

LCLCPNAME(MPLS)

Specifies that the name assigned to the local control point is MPLS. The remote systems specify this name as the remote control point name (RMTCPNAME) on the CRTCTLAPPC command.

LCLOCNAME(MPLS)

The default local location name is MPLS. This name will be used for the device description that is created by the APPN support.

NODETYPE(*NETNODE)

Specifies that the local system (MPLS) is an APPN network node.

Create the line description (Minneapolis to New York, switched): The line used in this example is an SDLC switched line. The command used to create the line is CRTLINS DLC. The parameters specified are:

LIND(NEWYORK)

The name assigned to the line description is NEWYORK.

RSRCNAME(LIN021)

Specifies that the physical communications port named LIN021 is being defined.

CNN(*SWTPP)

Specifies that this is a switched line connection.

AUTOANS(*NO)

Specifies that this system will not automatically answer an incoming call.

STNADR(01)

The address assigned to the local system is hex 01.

COSTCNN(128)

The relative cost of being connected to this line is 128; with 0 being the lowest cost and 255 the highest. This is used for route selection by the class of service.

COSTBYTE(128)

The relative cost of transferring a byte of data across this line is 128; with 0 being the lowest cost and 255 the highest. This is used for route selection by the class of service.

Create the controller description (Minneapolis to New York, switched): Because this is an APPN environment (iSeries system to iSeries system), the controller is an APPC controller and the CRTCTLAPPC command is used to define the attributes of the controller. The following attributes are defined by the example command:

CTLD(NEWYORK)

The name assigned to the controller description is NEWYORK.

LINKTYPE(*SDLC)

Because this controller is attached through an SDLC communications line, the value specified is *SDLC. This value must correspond to the type of line being used as defined by a create line description command.

SWITCHED(*YES)

Specifies that this controller is attached to a switched SDLC line.

SWTLINLST(NEWYORK)

Specifies the name (NEWYORK) of the line descriptions (for switched lines) that this controller can be attached to. In the example, there is only one line (NEWYORK). This value must match a name that is specified by the LIND parameter in a line description.

RMTNETID(APPN)

The name of the network in which the remote control point resides is APPN.

RMTCPNAME(NEWYORK)

Specifies that the remote control-point name is NEWYORK. The name specified here must match the name that is specified at the remote system for the local control-point name. In the example, the name is specified at the remote system (NEWYORK) by the LCLCPNAME parameter on the Change Network Attributes (CHGNETA) command.

INLCNN(*DIAL)

Specifies that the initial connection is made by the iSeries system either answering an incoming call or placing a call.

CNNNBR(2125551234)

The connection (telephone) number for the remote controller is 2125551234.

STNADR(01)

The address assigned to the remote controller is hex 01.

Create the line description A (Minneapolis to Chicago): The line used in this example is an SDLC nonswitched line. The command used to create the line is CRTLINS DLC. The parameters specified are:

LIND(CHICAGOL)

The name assigned to the line description is CHICAGOL.

RSRCNAME(LIN022)

Specifies that the physical communications port named LIN022 is being defined.

Create the controller description (Minneapolis to Chicago, nonswitched): Because this is an APPN environment (iSeries system to iSeries system), the controller is an APPC controller and the CRTCTLAPPC command is used to define the attributes of the controller. The example command defines the following attributes:

CTLD(CHICAGOL)

The name assigned to the controller description is CHICAGOL.

LINKTYPE(*SDLC)

Because this controller is attached through an SDLC communications line, the value specified is *SDLC. This value must correspond to the type of line being used as defined by a create line description command.

LINE(CHICAGOL)

Specifies the name (CHICAGOL) of the line description to which this controller is attached. This value must match a name that is specified by the LIND parameter in a line description.

RMTNETID(APPN)

The name of the network in which the remote control point resides is APPN.

RMTCPNAME(CHICAGO)

Specifies that the remote control-point name is CHICAGO. The name specified here must match the name that is specified at the remote system for the local control-point name. In the example, the name is specified at the remote system (CHICAGO) by the LCLCPNAME parameter on the Change Network Attributes (CHGNETA) command.

STNADR(01)

The address assigned to the remote controller is hex 01.

NODETYPE(*NETNODE)

Specifies that the remote location (CHICAGO) is an APPN networking node.

Create the line description B (Minneapolis to Chicago): The line used in this example is an SDLC switched line. The command used to create the line is CRTLINS DLC. The parameters specified are:

LIND(CHICAGOS)

The name assigned to the line description is CHICAGOS.

RSRCNAME(LIN031)

Specifies that the physical communications port named LIN031 is being defined.

CNN(*SWTPP)

Specifies that this is a switched line connection.

AUTOANS(*NO)

Specifies that this system will not automatically answer an incoming call.

STNADR(01)

The address assigned to the local system is hex 01.

COSTCNN(128)

The relative cost of being connected to this line is 128; with 0 being the lowest cost and 255 the highest. This is used for route selection by the class of service.

COSTBYTE(128)

The relative cost of transferring a byte of data across this line is 128; with 0 being the lowest cost and 255 the highest. This is used for route selection by the class of service.

Create the controller description (Minneapolis to Chicago, switched): Because this is an APPN environment (iSeries system to iSeries system), the controller is an APPC controller and the CRTCTLAPPC command is used to define the attributes of the controller. The example command defines the following attributes:

CTLD(CHICAGOS)

The name assigned to the controller description is CHICAGOS.

LINKTYPE(*SDLC)

Because this controller is attached through an SDLC communications line, the value specified is *SDLC. This value must correspond to the type of line being used as defined by a create line description command.

SWITCHED(*YES)

Specifies that this controller is attached to a switched SDLC line.

SWTLINLST(CHICAGOS)

Specifies the name (CHICAGOS) of the line descriptions (for switched lines) that this controller can be attached to. In the example, there is only one line (CHICAGOS). This value must match a name that is specified by the LIND parameter in a line description.

RMTNETID(APPN)

The name of the network in which the remote control point resides is APPN.

RMTCPPNAME(CHICAGO)

Specifies that the remote control-point name is CHICAGO. The name specified here must match the name that is specified at the remote system for the local control-point name. In the example, the name is specified at the remote system (CHICAGO) by the LCLCPNAME parameter on the Change Network Attributes (CHGNETA) command.

INLCNN(*ANS)

Specifies that the initial connection is made by the iSeries system answering an incoming call.

CNNNBR(3125551111)

The connection (telephone) number for the remote controller is 3125551111.

STNADR(01)

The address assigned to the remote controller is hex 01.

TMSGPNBR(3)

Specify the value (3) to be used by the APPN support for transmission group negotiation with the remote system.

The remote system must specify the same value for the transmission group.

NODETYPE(*NETNODE)

Specifies that the remote location (CHICAGO) is an APPN networking node.

Create the line description (Minneapolis to Los Angeles, switched): The line used in this example is an SDLC switched line. The command used to create the line is CRTLINS DLC. The parameters specified are:

LIND(LOSANGEL)

The name assigned to the line description is LOSANGEL.

RSRCNAME(LIN032)

Specifies that the physical communications port named LIN032 is being defined.

CNN(*SWTPP)

Specifies that this is a switched line connection.

AUTOANS(*NO)

Specifies that this system will not automatically answer an incoming call.

STNADR(01)

The address assigned to the local system is hex 01.

COSTCNN(128)

The relative cost of being connected to this line is 128; with 0 being the lowest cost and 255 the highest. This is used for route selection by the class of service.

COSTBYTE(128)

The relative cost of transferring a byte of data across this line is 128; with 0 being the lowest cost and 255 the highest. This is used for route selection by the class of service.

Create the controller description (Minneapolis to Los Angeles, switched): Because this is an APPN environment (iSeries system to iSeries system), the controller is an APPC controller and the CRTCTLAPPC command is used to define the attributes of the controller. The following attributes are defined by the example command:

CTLD(LOSANGEL)

The name assigned to the controller description is LOSANGEL.

LINKTYPE(*SDLC)

Because this controller is attached through an SDLC communications line, the value specified is *SDLC. This value must correspond to the type of line being used as defined by a create line description command.

SWITCHED(*YES)

Specifies that this controller is attached to a switched SDLC line.

SWTLINLST(LOSANGEL)

Specifies the name (LOSANGEL) of the line descriptions (for switched lines) that this controller can be attached to. In the example, there is only one line (LOSANGEL). This value must match a name that is specified by the LIND parameter in a line description.

RMTNETID(APPN)

The name of the network in which the remote control point resides is APPN.

RMTCPNAME(LOSANGEL)

Specifies that the remote control-point name is LOSANGEL. The name specified here must match the name that is specified at the remote system for the local control-point name. In the example, the name is specified at the remote system (LOSANGEL) by the LCLCPNAME parameter of the Change Network Attributes (CHGNETA) command.

INLCNN(*DIAL)

Specifies that the initial connection is made by the iSeries system either answering an incoming call or placing a call.

CNNNBR(2135553333)

The connection (telephone) number for the remote controller is 2135553333.

STNADR(01)

The address assigned to the remote controller is hex 01.

CPSSN(*NO)

Control point sessions are not supported with this node.

Create the line description (Minneapolis to token-ring network): The line used in this example is a token-ring network. The command used to create the line is CRTLINTRN and the parameters specified are:

LIND(MPLSTRN)

The name assigned to the line description is MPLSTRN.

RSRCNAME(LIN011)

Specifies that the physical communications port named LIN011 is being defined.

ADPTADR(400000000002)

Specifies the LAN adapter address for the local system.

Create the controller description (Minneapolis to Purchasing, token-ring network): Because this is an APPN environment (iSeries system to iSeries system), the controller is an APPC controller and the CRTCTLAPPC command is used to define the attributes of the controller. The following attributes are defined by the example command:

CTLD(PURCH)

The name assigned to the controller description is PURCH.

LINKTYPE(*LAN)

Because this controller is attached through a token-ring network communications line, the value specified is *LAN. This value must correspond to the type of line being used as defined by a create line description command.

SWITCHED(*YES)

Always specified as *YES for token-ring network connections.

SWTLINLST(MPLSTRN)

Specifies the name (MPLSTRN) of the line descriptions (in this case, a token-ring local area network line) that this controller can be attached to. In the example, there is only one line (MPLSTRN). This value must match a name that is specified by the LIND parameter in a line description.

RMTNETID(APPN)

The name of the network in which the remote control point resides is APPN.

RMTCPNAME(PURCH)

Specifies that the remote control-point name is PURCH. The name specified here must match the name that is specified at the remote system for the local control-point name. In the example, the name is specified at the remote system (PURCH) by the LCLCPNAME parameter of the Change Network Attributes (CHGNETA) command.

ADPTADR(400000000003)

Specifies the LAN adapter address of the remote controller. This must match the value specified at the remote controller (PURCH) in the associated line description.

MINSWTSTS(*VRYON)

Specifies that CP-CP sessions are established over this connection only when the status of the controller is varied on or active. This connection is to be treated as logically nonswitched for purposes of APPN routing.

SWTDSC(*NO)

Specifies that the switched connection is not disconnected when the last session is unbound. This must be specified because MINSWTSTS(*VRYON) is specified.

Create the controller description (Minneapolis to Distribution, token-ring network): Because this is an APPN environment (iSeries system to iSeries system), the controller is an APPC controller and the CRTCTLAPPC command is used to define the attributes of the controller. The following attributes are defined by the example command:

CTLD(DISTRIB)

The name assigned to the controller description is DISTRIB.

LINKTYPE(*LAN)

Because this controller is attached through a token-ring network communications line, the value specified is *LAN. This value must correspond to the type of line being used as defined by a create line description command.

SWITCHED(*YES)

Always specified as *YES for token-ring network connections.

SWTLINLST(MPLSTRN)

Specifies the name (MPLSTRN) of the line descriptions (in this case, a token-ring network line) that this controller can be attached to. In the example, there is only one line (MPLSTRN). This value must match a name that is specified by the LIND parameter in a line description.

RMTNETID(APPN)

The name of the network in which the remote control point resides is APPN.

RMTCPCNAME(DISTRIB)

Specifies that the remote control-point name is DISTRIB. The name specified here must match the name that is specified at the remote system for the local control-point name. In the example, the name is specified at the remote system (DISTRIB) by the LCLCPNAME parameter on the Change Network Attributes (CHGNETA) command.

ADPTADR(400000000004)

Specifies the LAN adapter address of the remote controller. This must match the value that is specified at the remote controller (DISTRIB) in the associated line description.

MINSWTSTS(*VRYON)

Specifies that CP-CP sessions are established over this connection only when the status of the controller is varied on or active. This connection is to be treated as logically nonswitched for purposes of APPN routing.

SWTDSC(*NO)

Specifies that the switched connection is not disconnected when the last session is unbound. This must be specified because MINSWTSTS(*VRYON) is specified.

Create the controller description (Minneapolis to Payroll, token-ring network): Because this is an APPN environment (iSeries system to iSeries system), the controller is an APPC controller and the CRTCTLAPPC command is used to define the attributes of the controller. The following attributes are defined by the example command:

CTLD(PAYROLL)

The name assigned to the controller description is PAYROLL.

LINKTYPE(*LAN)

Because this controller is attached through a token-ring network communications line, the value specified is *LAN. This value must correspond to the type of line being used as defined by a create line description command.

SWITCHED(*YES)

Always specified as *YES for token-ring network connections.

SWTLINLST(MPLSTRN)

Specifies the name (MPLSTRN) of the line descriptions (in this case, a token-ring local area network line) that this controller can be attached to. In the example, there is only one line (MPLSTRN). This value must match a name that is specified by the LIND parameter in a line description.

ADPTADR(400000000005)

Specifies the LAN adapter address of the remote controller. This must match the value that is specified at the remote controller (PAYROLL) in the associated line description.

RMTNETID(*NONE)

The PAYROLL controller is a low entry networking node and does not use a network ID.

RMTCPNAME(PAYROLL)

Specifies that the remote control-point name is PAYROLL. The name specified here must match the name that is specified at the remote system for the local control-point name. In the example, the name is specified at the remote system (PAYROLL) by the LCLCPNAME parameter on the Change Network Attributes (CHGNETA) command.

NODETYPE(*LENNODE)

Specifies that the remote location (PAYROLL) is a low-entry networking node in an APPN network.

Example: Configure end node 2 (Los Angeles): The following CL commands are used to define the configuration for the system that is identified as LOSANGEL (EN2 in the figure). The example shows these commands as used within a CL program; the configuration can also be performed using the configuration menus.

Note: Read the code disclaimer information for important legal information.

```
/******  
/*  
/* MODULE:  LOSANGEL          LIBRARY:  PUBSCFGS          */  
/*  
/* LANGUAGE:  CL          */  
/*  
/* FUNCTION:  CONFIGURES APPN NETWORK:          */  
/*  
/*          THIS IS: LOSANGEL TO MPLS   (switched)          */  
/*  
/*  
/*  
/*  
/******  
PGM  
          /* Change network attributes for LOSANGEL */  
          CHGNETA  LCLNETID(APPN) LCLCPNAME(LOSANGEL)  
                  LCLLOCNAME(LOSANGEL) NODETYPE(*ENDNODE)  
/******  
/*          LOSANGEL TO MPLS (switched)          */  
/******  
          /* Create switched line description for LOSANGEL TO MPLS */  
          CRTLINS DLC LIND(MPLS) RSRNAME(LIN041) CNN(*SWTPP)  
                  AUTOANS(*NO) STNADR(01) COSTCNN(128)  
                  COSTBYTE(128)  
          /* Create controller description for LOSANGEL TO MPLS */  
          CRTCTLAPPC CTLD(MPLS) LINKTYPE(*SDLC) SWITCHED(*YES)  
                  SWTLINLST(MPLS) RMTNETID(APPN)  
                  RMTCPNAME(MPLS) INLCNN(*DIAL)  
                  CNNNBR(6125553333) STNADR(01) CPSSN(*NO)  
                  NODETYPE(*NETNODE)  
ENDPGM
```

Change the network attributes (Los Angeles) in multiple-system network: The Change Network Attributes (CHGNETA) command is used to set the attributes for the system within the network. The following attributes are defined for LOSANGEL and these attributes apply to all connections in the network for this end node:

LCLNETID(APPN)

Specifies that the name of the local network is APPN. The remote locations (MPLS in the example, NN2 in the figure) must specify this name as the remote network identifier (RMTNETID) on the CRTCTLAPPC command.

LCLCPNAME(LOSANGEL)

Specifies that the name assigned to the local control point is LOSANGEL. The remote systems specify this name as the remote control point name (RMTCPNAME) on the CRTCTLAPPC command.

LCLLOCNAME(LOSANGEL)

The default local location name is LOSANGEL. This name will be used for the device description that is created by the APPN support.

NODETYPE(*ENDNODE)

Specifies that the local system (LOSANGEL) is an APPN end node.

Create the line description (Los Angeles to Minneapolis): The line used in this example is an SDLC switched line. The command used to create the line is CRTLINS DLC. The parameters specified are:

LIND(MPLS)

The name assigned to the line description is MPLS.

RSRCNAME(LIN041)

Specifies that the physical communications port named LIN041 is being defined.

CNN(*SWTPP)

Specifies that this is a switched line connection.

AUTOANS(*NO)

Specifies that this system will not automatically answer an incoming call.

STNADR(01)

The address assigned to the local system is hex 01.

COSTCNN(128)

The relative cost of being connected to this line is 128, with 0 being the lowest cost and 255 the highest. This is used for route selection by the class of service.

COSTBYTE(128)

The relative cost of transferring a byte of data across this line is 128, with 0 being the lowest cost and 255 the highest. This is used for route selection by the class of service.

Create the controller description (Los Angeles to Minneapolis): Because this is an APPN environment (iSeries system to iSeries system), the controller is an APPC controller and the CRTCTLAPPC command is used to define the attributes of the controller. The example command defines the following attributes:

CTLD(MPLS)

The name assigned to the controller description is MPLS.

LINKTYPE(*SDLC)

Because this controller is attached through an SDLC communications line, the value specified is *SDLC. This value must correspond to the type of line being used as defined by a create line description command.

SWITCHED(*YES)

Specifies that this controller is attached to a switched SDLC line.

SWTLINLST(MPLS)

Specifies the name (MPLS) of the line description (for switched lines) that this controller can be

attached to. In the example, there is only one line (MPLS). This value must match a name that is specified by the LIND parameter in a line description.

RMTNETID(APPN)

The name of the network in which the remote control point resides is APPN.

RMTCPNAME(MPLS)

Specifies that the remote control-point name is MPLS. The name specified here must match the name that is specified at the remote system for the local control-point name. In the example, the name is specified at the remote system (MPLS) by the LCLCPNAME parameter of the Change Network Attributes (CHGNETA) command.

INLCNN(*DIAL)

Specifies that the initial connection is made by the iSeries system either answering an incoming call or placing a call.

CNNNBR(6125553333)

The connection (telephone) number for the remote controller is 6125553333.

STNADR(01)

The address assigned to the remote controller is hex 01.

CPSSN(*NO)

Control point sessions are not supported with this node.

NODETYPE(*NETNODE)

Specifies that the remote location (MPLS) is an APPN networking node.

Example: Configure end node A (Purchasing): The following CL commands are used to define the configuration for the system identified as PURCH (ENA in the figure). The example shows these commands as used within a CL program; the configuration can also be performed using the configuration menus.

Note: Read the code disclaimer information for important legal information.

```
/******  
/*  
/* MODULE: PURCH LIBRARY: PUBSCFGS */  
/*  
/* LANGUAGE: CL */  
/*  
/* FUNCTION: CONFIGURES APPN NETWORK: */  
/*  
/* THIS IS: PURCH TO MPLS (LAN) */  
/* PURCH TO DISTRIB (LAN) */  
/*  
/*  
/******  
PGM  
/******  
/* Change network attributes for PURCH */  
CHGNETA LCLNETID(APPN) LCLCPNAME(PURCH)  
LCLLOCNAME(PURCH) NODETYPE(*ENDNODE)  
NETSERVER((APPN MPLS))  
/* Create remote configuration list for PURCH */  
CRTCFG L TYPE(*APPNRMT) APPNRMT((NEWYORK APPN  
PURCH NEWYORK APPN 3BD29F *YES *NO *NO *NO  
'RMT LOC OF PURCH')  
(LOSANGEL APPN  
PURCH LOSANGEL APPN 3BD29F *YES *NO *NO *NO  
'RMT LOC OF PURCH'))  
/* Create LAN line description for PURCH to LAN */  
CRTLINTRN LIND(MPLSTRN) RSRNAME(LIN031)  
ADPTADR(400000000003)  
/* Create controller description for PURCH to MPLS */
```

```

CRTCTLAPPC CTLD(MPLS) LINKTYPE(*LAN) SWITCHED(*YES)
          SWTLINLST(MPLSTRN) RMTNETID(APPN)
          RMTCPNAME(MPLS) ADPTADR(400000000002)
          MINSWTSTS(*VRYON) SWTDSC(*NO)
          NODETYPE(*NETNODE)
/* Create controller description for PURCH to DISTRIB */
CRTCTLAPPC CTLD(DISTRIB) LINKTYPE(*LAN) SWITCHED(*YES)
          SWTLINLST(MPLSTRN) RMTNETID(APPN)
          RMTCPNAME(DISTRIB) ADPTADR(400000000004)
          MINSWTSTS(*VRYON) SWTDSC(*NO)

```

ENDPGM

Change the network attributes (Purchasing): The Change Network Attributes (CHGNETA) command is used to set the attributes for the system within the network. The following attributes are defined for PURCH and these attributes apply to all connections in the network for this end node:

LCLNETID(APPN)

Specifies that the name of the local network is APPN. The remote locations (MPLS in the example, NN2 in the figure) must specify this name as the remote network identifier (RMTNETID) on the CRTCTLAPPC command.

LCLCPNAME(PURCH)

Specifies that the name assigned to the local control point is PURCH. The remote systems specify this name as the remote control point name (RMTCPNAME) on the CRTCTLAPPC command.

LCLLOCNAME(PURCH)

The default local location name is PURCH. This name will be used for the device description that is created by the APPN support.

NODETYPE(*ENDNODE)

Specifies that the local system (PURCH) is an APPN end node.

NETSERVER((APPN MPLS))

Specifies that network node MPLS (NN2 in the figure) is the network node server for this end point. The MPLS node is in the same (APPN) network.

Create the remote location configuration list (Purchasing): The Create Configuration List (CRTCFGL) command is used to define the remote locations with special characteristics to the APPN support. In this example, location security is being used and the following is defined at PURCH:

TYPE(*APPNRMT)

Specifies that the entries being defined are remote locations.

```

APPNRMTE((NEWYORK APPN PURCH NEWYORK APPN 3BD29F *YES *NO *NO *NO 'RMT LOC
of PURCH') (LOSANGEL APPN PURCH LOSANGEL APPN 3BD29F *YES *NO *NO *NO 'RMT LOC
of PURCH'))

```

Specifies the remote locations with which the local location can be paired. Two entries are defined:

- For the first entry:
 - The remote location name is NEWYORK
 - The remote network ID is APPN
 - The associated local location name is PURCH (defined by the default local location name);
 - The control-point name is NEWYORK and the remote control point network ID is also APPN
 - The password is 3BD29F
 - It is a secure location
 - It is not a single session location. The last two entries locally controlled sessions and pre-established sessions, are *NO because this is not a single session location.
- For the second entry:
 - The remote location name is LOSANGEL
 - The remote network ID is APPN

- The associated local location name is PURCH (defined by the local location list)
- The control-point name is LOSANGEL the control point network ID is also APPN
- The password is 3BD29F
- It is a secure location
- It is not a single session location. The last two entries locally controlled sessions and preestablished sessions, are *NO because this is not a single session location.

Create the line description (Purchasing to token-ring network): The line used in this example is a token-ring network. The command used to create the line is CRTLINTRN and the parameters specified are:

LIND(MPLSTRN)

The name assigned to the line description is MPLSTRN.

RSRCNAME(LIN031)

Specifies that the physical communications port named LIN031 is being defined.

ADPTADR(400000000003)

Specifies the LAN adapter address of the local system.

Create the controller description (Purchasing to Minneapolis, token-ring network): Because this is an APPN environment (iSeries system to iSeries system), the controller is an APPC controller and the CRTCTLAPPC command is used to define the attributes of the controller. The following attributes are defined by the example command:

CTLD(MPLS)

The name assigned to the controller description is MPLS.

LINKTYPE(*LAN)

Because this controller is attached through a token-ring network communications line, the value specified is *LAN. This value must correspond to the type of line being used as defined by a create line description command.

SWITCHED(*YES)

Always specified as *YES for token-ring network connections.

SWTLINLST(MPLSTRN)

Specifies the name of the line descriptions (in this case, a token-ring network line) that this controller can be attached to. In the example, there is only one line (MPLSTRN). This value must match a name that is specified by the LIND parameter in a line description.

RMTNETID(APPN)

The name of the network in which the remote control point resides is APPN.

RMTCPNAME(MPLS)

Specifies that the remote control-point name is MPLS. The name specified here must match the name that is specified at the remote system for the local control-point name. In the example, the name is specified at the remote system (MPLS) by the LCLCPNAME parameter on the Change Network Attributes (CHGNETA) command.

ADPTADR(400000000002)

Specifies the LAN adapter address of the remote controller. This must match the value that is specified at the remote controller (MPLS) in the associated line description.

MINSWTSTS(*VRYON)

Specifies that CP-CP sessions are established over this connection only when the status of the controller is varied on or active. This connection is to be treated as logically nonswitched for purposes of APPN routing.

SWTDSC(*NO)

Specifies that the switched connection will not be disconnected when the last device is varied off. This must be specified since MINSWTSTS(*VRYON) is specified.

NODETYPE(*NETNODE)

Specifies that the remote location (MPLS) is an APPN networking node.

Create the controller description (Purchasing to Distribution, token-ring network): Because this is an APPN environment (iSeries system to iSeries system), the controller is an APPC controller and the CRTCTLAPPC command is used to define the attributes of the controller. The example command defines the following attributes:

CTLD(DISTRIB)

The name assigned to the controller description is DISTRIB.

LINKTYPE(*LAN)

Because this controller is attached through a token-ring network communications line, the value specified is *LAN. This value must correspond to the type of line being used as defined by a create line description command.

SWITCHED(*YES)

Always specified as *YES for token-ring network connections.

SWTLINLST(MPLSTRN)

Specifies the name (MPLSTRN) of the line descriptions (in this case, a token-ring network line) that this controller can be attached to. In the example, there is only one line (MPLSTRN). This value must match a name that is specified by the LIND parameter in a line description.

RMTNETID(APPN)

The name of the network in which the remote control point resides is APPN.

RMTCPCNAME(DISTRIB)

Specifies that the remote control-point name is DISTRIB. The name specified here must match the name that is specified at the remote system for the local control-point name. In the example, the name is specified at the remote system (DISTRIB) by the LCLCPNAME parameter of the Change Network Attributes (CHGNETA) command.

ADPTADR(400000000004)

Specifies the LAN adapter address of the remote controller. This must match the value specified at the remote controller (DISTRIB) in the associated line description.

MINSWTSTS(*VRYON)

Specifies that CP-CP sessions are established over this connection only when the status of the controller is varied on or active. This connection is to be treated as logically nonswitched for purposes of APPN routing.

SWTDSC(*NO)

Specifies that the switched connection will not be disconnected when the last device is varied off. This must be specified since MINSWTSTS(*VRYON) is specified.

Example: Configure end node B (Distribution): The following CL commands are used to define the configuration for the system that is identified as DISTRIB (ENB in the figure). The example shows these commands as used within a CL program; the configuration can also be performed using the configuration menus.

Note: Read the code disclaimer information for important legal information.

```
/*
/*
/* MODULE:  DISTRIB                LIBRARY:  PUBSCFGS          */
/*
/* LANGUAGE:  CL                    */
/*
```

```

/* FUNCTION: CONFIGURES APPN NETWORK: */
/* */
/* THIS IS: DISTRIB TO MPLS (LAN) */
/* DISTRIB TO PURCH (LAN) */
/* */
/* */
/*****/
PGM
/*****/
/* Change network attributes for DISTRIB */
CHGNETA LCLNETID(APPN) LCLCPNAME(DISTRIB)
        LCLLOCNAME(DISTRIB) NODETYPE(*ENDNODE)
        NETSERVER((APPN MPLS))
/*****/
/* DISTRIB TO LAN (LAN) */
/*****/
/* Create LAN line description for DISTRIB to LAN */
CRTLINTRN LIND(MPLSTRN) RSRNAME(LIN031)
          ADPTADR(400000000004)
/* Create controller description for DISTRIB to MPLS */
CRTCTLAPPC CTLD(MPLS) LINKTYPE(*LAN) SWITCHED(*YES)
          SWTLINLST(MPLSTRN) RMTNETID(APPN)
          RMTCPNAME(MPLS) ADPTADR(400000000002)
          MINSWTSTS(*VRYON) SWTDSC(*NO)
          NODETYPE(*NETNODE)
/* Create controller description for DISTRIB to PURCH */
CRTCTLAPPC CTLD(PURCH) LINKTYPE(*LAN) SWITCHED(*YES)
          SWTLINLST(MPLSTRN) RMTNETID(APPN)
          RMTCPNAME(PURCH) ADPTADR(400000000003)
          MINSWTSTS(*VRYON) SWTDSC(*NO)

ENDPGM

```

Change the network attributes (Distribution): The Change Network Attributes (CHGNETA) command is used to set the attributes for the system within the network. The following attributes are defined for DISTRIB and these attributes apply to all connections in the network for this end node.

LCLNETID(APPN)

Specifies that the name of the local network is APPN. The remote locations (MPLS in the example, NN2 in Figure 8 on page 51 must specify this name as the remote network identifier (RMTNETID) on the CRTCTLAPPC command.

LCLCPNAME(DISTRIB)

Specifies that the name assigned to the local control point is DISTRIB. The remote systems specify this name as the remote control point name (RMTCPNAME) on the CRTCTLAPPC command.

LCLLOCNAME(DISTRIB)

The default local location name is DISTRIB. This name will be used for the device description that is created by the APPN support.

NODETYPE(*ENDNODE)

Specifies that the local system (DISTRIB) is an APPN end node.

NETSERVER((APPN MPLS))

Specifies that network node MPLS (NN2 in Figure 8 on page 51) is the network node server for this end point. The MPLS node is in the same (APPN) network.

Create the line description (Distribution to token-ring network): The line used in this example is a token-ring local are network. The command used to create the line is CRTLINTRN and the parameters specified are:

LIND(MPLSTRN)

The name assigned to the line description is MPLSTRN.

RSRCNAME(LIN031)

Specifies that the physical communications port named LIN031 is being defined.

ADPTADR(400000000004)

Specifies the LAN adapter address of the local system.

Create the controller description (Distribution to Minneapolis, token-ring network): Because this is an APPN environment (iSeries system to iSeries system), the controller is an APPC controller and the CRTCTLAPPC command is used to define the attributes of the controller. The example command defines the following attributes:

CTLD(MPLS)

The name assigned to the controller description is MPLS.

LINKTYPE(*LAN)

Because this controller is attached through a token-ring network communications line, the value specified is *LAN. This value must correspond to the type of line being used as defined by a create line description command.

SWITCHED(*YES)

Always specified as *YES for token-ring network connections.

SWTLINLST(MPLSTRN)

Specifies the name (MPLSTRN) of the line descriptions (in this case, a token-ring network line) that this controller can be attached to. In the example, there is only one line (MPLSTRN). This value must match a name that is specified by the LIND parameter in a line description.

RMTNETID(APPN)

The name of the network in which the remote control point resides is APPN.

RMTCPNAME(MPLS)

Specifies that the remote control-point name is MPLS. The name specified here must match the name that is specified at the remote system for the local control-point name. In the example, the name is specified at the remote system (MPLS) by the LCLCPNAME parameter of the Change Network Attributes (CHGNETA) command.

ADPTADR(400000000002)

Specifies the LAN adapter address of the remote controller. This must match the value that is specified at the remote controller (MPLS) in the associated line description.

MINSWTSTS(*VRYON)

Specifies that CP-CP sessions are established over this connection only when the status of the controller is varied on or active. This connection is to be treated as logically nonswitched for purposes of APPN routing.

SWTDSC(*NO)

Specifies that the switched connection will not be disconnected when the last device is varied off. This must be specified since MINSWTSTS(*VRYON) is specified.

NODETYPE(*NETNODE)

Specifies that the remote location (MPLS) is an APPN networking node.

Create the controller description (Distribution to Purchasing, token-ring network): Because this is an APPN environment (iSeries system to iSeries system), the controller is an APPC controller and the CRTCTLAPPC command is used to define the attributes of the controller. The example command defines the following attributes:

CTLD(PURCH)

The name assigned to the controller description is PURCH.

LINKTYPE(*LAN)

Because this controller is attached through a token-ring network communications line, the value specified is *LAN. This value must correspond to the type of line being used as defined by a create line description command.

SWITCHED(*YES)

Always specified as *YES for token-ring network connections.

SWTLINLST(MPLSTRN)

Specifies the name (MPLSTRN) of the line descriptions (in this case, a token-ring network line) that this controller can be attached to. In the example, there is only one line (MPLSTRN). This value must match a name that is specified by the LIND parameter in a line description.

RMTNETID(APPN)

The name of the network in which the remote control point resides is APPN.

RMTCPPNAME(PURCH)

Specifies that the remote control-point name is PURCH. The name specified here must match the name that is specified at the remote system for the local control-point name. In the example, the name is specified at the remote system (PURCH) by the LCLCPNAME parameter of the Change Network Attributes (CHGNETA) command.

ADPTADR(400000000003)

Specifies the LAN adapter address of the remote controller. This must match the value that is specified at the remote controller (DISTRIB) in the associated line description.

MINSWTSTS(*VRYON)

Specifies that CP-CP sessions are established over this connection only when the status of the controller is varied on or active. This connection is to be treated as logically nonswitched for purposes of APPN routing.

SWTDSC(*NO)

Specifies that the switched connection will not be disconnected when the last device is varied off. This must be specified since MINSWTSTS(*VRYON) is specified.

Example: Configure low entry networking end node 1 (Payroll): The following CL commands are used to define the configuration for the system identified as PAYROLL (LENN1 in Figure 8 on page 51). The example shows these commands as used within a CL program; the configuration can also be performed using the configuration menus.

Note: Read the code disclaimer information for important legal information.

```
/******  
/*  
/* MODULE: PAYROLL LIBRARY: PUBSCFGS */  
/*  
/* LANGUAGE: CL */  
/*  
/* FUNCTION: CONFIGURES APPN NETWORK: */  
/*  
/* THIS IS: PAYROLL TO MPLS (LAN) */  
/* PAYROLL TO NEWYORK (LAN) */  
/* PAYROLL TO LOSANGEL (LAN) */  
/*  
/******  
PGM  
/******  
/* Create LAN line description for PAYROLL to LAN */  
CRTLINTRN LIND(MPLSTRN) RSRNAME(LIN011)  
ADPTADR(400000000005)  
/* Create controller description for PAYROLL to MPLS */  
CRTCTLAPPC CTLD(MPLS) LINKTYPE(*LAN) SWITCHED(*YES)  
SWTLINLST(MPLSTRN) RMTNETID(APPN)  
RMTCPPNAME(MPLS) ADPTADR(400000000002)  
APPN(*NO)  
/* Create device description for NEWYORK */  
CRTDEVAPPC DEVD(NEWYORK) LOCADR(00) RMTLOCNAME(NEWYORK)  
LCLLOCNAME(PAYROLL) APPN(*NO)  
CTL(MPLS) MODE(BLANK #BATCH)
```

```

/* Create device description for LOSANGEL */
CRTDEVAPPC DEVD(LOSANGEL) LOCADR(00) RMTLOCNAME(LOSANGEL)
          LCLLOCNAME(PAYROLL) APPN(*NO)
          CTL(MPLS) MODE(BLANK #BATCH)
/* Create device description for MPLS */
CRTDEVAPPC DEVD(MPLS) LOCADR(00) RMTLOCNAME(MPLS)
          LCLLOCNAME(PAYROLL) APPN(*NO)
          CTL(MPLS) MODE(BLANK #BATCH)

```

ENDPGM

Create the line description (Payroll to token-ring network): The line used in this example is a token-ring network. The command used to create the line is CRTLINTRN and the parameters specified are:

LIND(MPLSTRN)

The name assigned to the line description is MPLSTRN.

RSRCNAME(LIN011)

Specifies that the physical communications port named LIN011 is being defined.

ADPTADR(400000000005)

Specifies the LAN adapter address of the local system.

Create the controller description (Payroll to token-ring network): Because this is an APPN environment (iSeries system to iSeries system), the controller is an APPC controller and the CRTCTLAPPC command is used to define the attributes of the controller. The following attributes are defined by the example command:

CTLD(MPLS)

The name assigned to the controller description is MPLS.

LINKTYPE(*LAN)

Because this controller is attached through a token-ring network communications line, the value specified is *LAN. This value must correspond to the type of line being used as defined by a create line description command.

SWITCHED(*YES)

Always specified as *YES for token-ring network connections.

SWTLINLST(MPLSTRN)

Specifies the name (MPLSTRN) of the line descriptions (in this case, a token-ring network line) that this controller can be attached to. In the example, there is only one line (MPLSTRN). This value must match a name that is specified by the LIND parameter in a line description.

RMTNETID(APPN)

The name of the network in which the remote control point resides is APPN.

RMTCPNAME(MPLS)

Specifies that the remote control-point name is MPLS. The name specified here must match the name that is specified at the remote system for the local control-point name. In the example, the name is specified at the remote system (MPLS) by the LCLCPNAME parameter on the Change Network Attributes (CHGNETA) command.

ADPTADR(400000000002)

Specifies the LAN adapter address of the remote controller. This must match the value that is specified at the remote controller (MPLS) in the associated line description.

APPN(*NO)

Specifies that this link does not use APPN networking support. All the devices must be specifically defined to the local system using the CRTDEVAPPC command.

Create the APPC device (Payroll to New York): Because this is an APPC/APPN environment, the device is an APPC device and the CRTDEVAPPC command is used to define the attributes of the device. The following attributes are defined by the example command:

DEV(DNEWYORK)

Specifies that the name assigned to the device description is NEWYORK.

LOCADR(00)

The location address should always be specified as hex 00 when the device is associated with an APPC controller.

RMTLOCNAME(NEWYORK)

Specifies that the remote location name associated with this device description is NEWYORK.

This value matches the value that is specified for the LCLLOCNAME parameter at the other system (NEWYORK).

LCLLOCNAME(PAYROLL)

Specifies the name that is assigned to the local location, which is PAYROLL in the example.

This value matches the value that is specified for the RMTLOCNAME parameter at the other system (NEWYORK).

APPN(*NO)

Specifies that the networking support is not used.

CTL(MPLS)

Specifies that this device description is attached to a controller description that is named MPLS.

MODE(BLANK #BATCH)

Specifies that this device will use either of two modes: BLANK, which is a mode name of all blanks (hex 40), or #BATCH. Both these modes are supplied by IBM. Note that the other location must also use one of these modes when communicating with this location.

Create the APPC device (Payroll to Los Angeles): Because this is an APPC/APPN environment, the device is an APPC device and the CRTDEVAPPC command is used to define the attributes of the device. The following attributes are defined by the example command:

DEV(DLOSANGEL)

Specifies that the name assigned to the device description is LOSANGEL.

LOCADR(00)

The location address should always be specified as hex 00 when the device is associated with an APPC controller.

RMTLOCNAME(LOSANGEL)

Specifies that the remote location name associated with this device description is LOSANGEL.

This value matches the value that is specified for the LCLLOCNAME parameter at the other system (LOSANGEL).

LCLLOCNAME(PAYROLL)

Specifies the name that is assigned to the local location, which is PAYROLL in the example.

This value matches the value that is specified for the RMTLOCNAME parameter at the other system (LOSANGEL).

APPN(*NO)

Specifies that the networking support is not used.

CTL(MPLS)

Specifies that this device description is attached to a controller description that is named MPLS.

MODE(BLANK #BATCH)

Specifies that this device will use either of two modes: BLANK, which is a mode name of all blanks

(hex 40), or #BATCH. Both these modes are supplied by IBM. Note that the other location must also use one of these modes when communicating with this location.

Create the APPC device (Payroll to Minneapolis): Because this is an APPC/APPN environment, the device is an APPC device and the CRTDEVAPPC command is used to define the attributes of the device. The following attributes are defined by the example command:

DEV(D(MPLS)

Specifies that the name assigned to the device description is MPLS.

LOCADR(00)

The location address should always be specified as hex 00 when the device is associated with an APPC controller.

RMTLOCNAME(MPLS)

Specifies that the remote location name associated with this device description is MPLS.

This value matches the value that is specified for the LCLLOCNAME parameter at the other system (MPLS).

LCLLOCNAME(PAYROLL)

Specifies the name that is assigned to the local location, which is PAYROLL in the example.

This value matches the value that is specified for the RMTLOCNAME parameter at the other system (MPLS).

APPN(*NO)

Specifies that the networking support is not used.

CTL(MPLS)

Specifies that this device description is attached to a controller description that is named MPLS.

MODE(BLANK #BATCH)

Specifies that this device will use either of two modes: BLANK, which is a mode name of all blanks (hex 40), or #BATCH. IBM supplies both these modes. Note that the other location must also use one of these modes when communicating with this location.

Examples: Configure HPR

See the following examples for a variety of ways to configure HPR:

- “Example: Two iSeries systems as network nodes using HPR”
- “Example: Three iSeries systems using HPR” on page 80

Example: Two iSeries systems as network nodes using HPR

To configure HPR, you must first configure APPN properly. Refer to the page, Two iSeries systems as network nodes using APPN for this configuration setup.

Note: Systems NN1 and NN2, shown below, must have the Allow HPR transport tower support (ALWHPRTWR) parameter set to (*YES).

In Figure 9, both systems are configured as network nodes in the network attributes. This example shows an APPN configuration using a switched line and a nonswitched line.

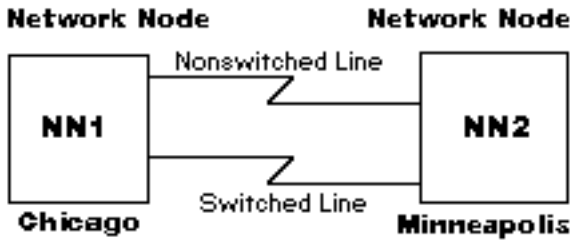

RSL3584-0

Figure 9. HPR two-system network

Example: Three iSeries systems using HPR

To configure HPR, you must first configure APPN properly. To do this refer to the page, Three iSeries systems using APPN.

Notes:

1. Systems A and B, shown below, must have the Allow HPR transport tower support (ALWHPRTWR) parameter set to (*YES). These systems must be V4R2 or greater.
2. The intermediate system must be V3R1 or greater, with the appropriate hardware.

In Figure 10, A and B are end nodes. The network node must configure its network attributes to reflect that it is a network node. Each system must configure the remote control-point name in the controller description that represent the adjacent system. Also, A and B must indicate in the controller description for the network node that it can be a network node. A and B must add the network node to the server list in network attributes so that the network node might act as a network server for both end nodes.

Note: Neither end node needs to configure any information about the other end node.

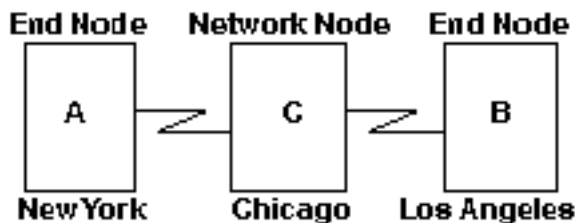

RSL3512-3

Figure 10. Three-system HPR network

Optimize APPN and HPR communication performance

If you are responsible for network administration, then you may be concerned with the speed at which computers throughout that network can exchange data. Fortunately, you can manage the ability of a network to perform work and remain robust. The higher the performance, the more jobs a network can handle. In addition, you must consider the individual components that make up the systems in your network, in relation to the environment in which that system is running. If you have decided to configure an APPN and HPR network, review the following topics:

- “Performance considerations for APPN and HPR” on page 81
- “Optimize communications using high-performance routing” on page 82
- “APPN virtual controllers and communications performance” on page 83

- “Fine-tune configuration parameters for APPC performance” on page 84

Performance considerations for APPN and HPR

The following can affect the performance of the APPN and HPR protocols:

- Transmission priority

When you create a class-of-service description, you can define one of three transmission priorities for each class of service. You can specify, using the transmission priority (TMSPTY) parameter, that the transmission priority for any class of service is high, medium, or low.

The transmission priority you specify is carried in the session activation request at session establishment. The transmission priority allows each logical unit on the session and each routing entry along the session path to store the same transmission priority. By assigning an appropriate mode (which includes a class of service) at session activation time, you can ensure a better response time for the applications that require it. Generally, interactive traffic should have a high priority and batch traffic a low priority.

- Route addition resistance

Route addition resistance (RAR) is a relative value that indicates how desirable one network node is, as compared to other network nodes, for having intermediate sessions routed through it.

Changing this value and working with the different class-of-service descriptions can control route sessions.

The RAR value is defined in the network attributes for the local iSeries system.

- Pacing values: See Pacing (INPACING, OUTPACING, MAXINPACING) parameters for pacing considerations.
- Session activation considerations

When a session is requested to a remote location that matches a network node control-point name, a directory search is not performed by the node that calculates the route. This is true if the session request is being started by a user on the network node, or on an end node that the network node is providing services for. Session start requests for remote locations in end nodes and remote locations in network nodes that do not match the control-point name of the network nodes take longer. These session start requests take longer because the directory search needs to be sent and the replies need to be received.

- Maximum intermediate sessions

The Change Network Attributes (CHGNETA) command specifies the maximum number of intermediate sessions that are allowed on a network node. When the number of intermediate sessions reaches 90% of the maximum value, the node is marked as congested. A node that is congested may or may not be used for intermediate sessions that depend on the class-of-service definition. The node is not congested when the number of intermediate sessions drops below 80% of the configured value. Also, if the maximum number of intermediate sessions is reached (100%), then intermediate sessions will not be allowed through this network node until the value drops. You can limit the effect of intermediate sessions on local processing by setting an appropriate value.

- Segmentation and reassembly

On iSeries, some IOPs that support the local area network protocols, such as token ring and Ethernet, have the ability to perform segmentation and reassembly of SNA Request Units. Performing this function in the IOPs offloads this work from the server CPU. The server CPU is free to perform other tasks.

Note: Communications input/output adapters (IOAs), such as Gigabit Ethernet, do not require an input/output processor (IOP) and therefore perform segmentation in the server CPU. Gigabit Ethernet adapters do not automatically support SNA. Enterprise Extender (or AnyNet) is required to allow SNA data to flow over a Gigabit adapter. IBM recommends that Enterprise Extender be used in place of AnyNet.

With APPN, any network congestion control is handled on a hop-by-hop basis by using pacing values. It is possible to over-drive connections in an APPN environment. A particular system might receive more data over a communications link than it can handle based on buffer space. The system requires

the node that sends the data to retransmit all of the frames that were sent following the last successfully acknowledged frame. This retransmission occurs at the data link control (DLC) layer.

Note: HPR has little IOP assistance. Much of the segmentation and reassembly is done in the server CPU.

- Error recovery

APPN requires link-level error recovery to cause retransmission of lost frames. This link-level error recovery can only survive short and temporary outages (several seconds). If a link outage or node outage occurs, that is of longer duration, APPN has no recovery mechanisms for keeping the affected sessions active. The applications must handle any session recovery.

The following matrix shows how HPR traffic is supported between two systems that are based on their HPR link-level error recovery settings. The HPR link-level error settings are exchanged between the systems:

System 1	System 2		
	No link-level ERP allowed	Link-level ERP required	Prefer no link-level ERP but might run using link-level ERP
No link-level ERP allowed	HPR supported (no ERP)	HPR not used	HPR supported (no ERP)
Link-level ERP required	HPR not used	HPR supported (uses ERP)	HPR supported (uses ERP)
Prefer no link-level ERP but might run using link-level ERP	HPR supported (no ERP)	HPR supported (uses ERP)	HPR supported (no ERP)

For information about high-performance routing, see “Optimize communications using high-performance routing.”

Optimize communications using high-performance routing

High-performance routing (HPR) is the next evolution of Advanced Peer-to-Peer Networking (APPN). HPR is an extension of APPN and has many functional aspects common with APPN. Configuring adjacent stations, search processing, and route computation are the same in APPN and HPR. HPR differs from APPN in the areas of transport, intermediate session routing, congestion control, and error recovery.

The following are the HPR protocol operational characteristics:

HPR supports a key availability enhancement that is called non-disruptive path switching. This function provides the ability to recover from link or node outages without having session failures. This makes the outage transparent to the application. The application may experience a response time delay while data traffic is being rerouted. On iSeries, the amount of time the system takes to establish a new path, or re-establish the original failed route path is configurable. This error recovery feature is the key difference between APPN and HPR.

HPR can support the non-disruptive path switching feature because of an enhanced data transport mechanism that is called Rapid Transport Protocol (RTP). RTP is the data transport protocol that is used between a pair of systems that support the HPR RTP tower. This pair of systems establishes an RTP connection which carries out APPN sessions (multiple APPN sessions can be multiplexed over a single RTP connection). In order to establish an RTP connection between a pair of HPR RTP tower systems, the following must be true:

- The set of nodes must support the HPR intermediate routing function.
- The transmission groups (TGs) that exist between the two HPR RTP tower systems must support the HPR intermediate routing function.

This routing is known as Automatic Network Routing (ANR).

When an RTP node sends packets of data, it must keep those buffers until the RTP node receives acknowledgment that its RTP partner has successfully received the data. Maintaining detailed knowledge of data sent and received is necessary in order to provide the additional value provided by HPR, the non-disruptive path switching function. HPR does not rely on the data link layer to provide data retransmission functions. HPR supports a function that is called selective retransmission. With selective retransmission, only the data which has not been acknowledged gets retransmitted. For example, if an RTP node sends eight packets and all but the fourth packet is successfully acknowledged, then only the fourth would retransmit. This differs from other retransmission algorithms in which the first unsuccessful packet and all the subsequent packets would transmit.

Nodes performing intermediate routing of HPR traffic or ANR, have no session awareness. HPR uses source routing. The nodes performing ANR examine packets as they receive them and determine the next hop of the route. The next hop is based on something that is called the ANR label. All HPR packets contain the ANR label. Any ANR that a network node is performing does **not** count as an APPN intermediate session. The maximum intermediate sessions parameter that is configured by means of the Change Network Attribute (CHGNETA) command has no effect on the ANR capacity of a system. Controlling the amount of ANR that different systems will perform in a network is completely dependent on the route selection phase of APPN session establishment.

When sessions are carried over RTP connections, any segmentation, or reassembly is performed within the iSeries central processing unit (CPU). The communications IOPs do not have the information required to perform the segmentation and reassembly. The IOPs can not maintain the knowledge that is required by HPR to perform the data retransmission and non-disruptive path switching function.

HPR uses a function called Adaptive Rated Based (ARB) congestion control. ARB regulates the flow of traffic by predicting congestion in the network and reducing the sending rate of a node into the network. ARB then attempts to prevent congestion rather than reacting to it after it has occurred. If all of the traffic occurring over a network was HPR, then ARB would be a fair way of sharing the bandwidth of a network. ARB also allows high utilization of the networking resources. When HPR traffic mixes with straight APPN or TCP/IP traffic, the HPR throughput may suffer because the other protocols do not practice similar congestion control techniques.

For more information about configuring HPR, see “Configure APPC, APPN, and HPR” on page 4.

APPN virtual controllers and communications performance

An **APPN virtual controller** is a controller description that Advanced Peer-to-Peer Networking (APPN) can use, and that high-performance routing (HPR) support uses. It can be used to attach and manage advanced program-to-program communications (APPC) device descriptions. This type of controller does not represent a connection to a remote system. On iSeries, local applications that need to establish LU 6.2 sessions to other locations in the APPN network require an APPC device description that specifies APPN(*YES). For simplicity, these devices are referred to as APPN devices.

The Allow APPN virtual support (ALWVRTAPPN) parameter is on the Change Network Attributes (CHGNETA) command. If the ALWVRTAPPN parameter is *YES, any existing APPN devices that are attached to the real APPN controller description will not be allowed to vary on. Message CPDB157 will be issued. If migrating to this new APPN object model, you may want to delete any existing APPN devices because they will no longer be used. You may also want to delete the devices if you have no intention of resetting the ALWVRTAPPN parameter to *NO.

APPN virtual controllers provide the following:

- Virtual controllers can reduce the number of device descriptions

| Prior to supporting APPN virtual controllers, multiple APPN device descriptions can be created and
| used simultaneously to communicate between the same local location and remote location pair. This
| situation was possible because alternate paths exist through the network. The first hop out of the local
| system (that is represented by a controller description) can be different for the two paths. After a

session is established, the same APPN device description is used for the life of that session. With APPN virtual controller support, you can accomplish all communications between the same local location and remote location pair using a single device description. This single device description can be used, even if multiple paths to that remote location exist in the network.

- Virtual controllers bypass 254 device limit

iSeries allows a maximum of 254 devices to attach to a controller description. In some environments, there may be a requirement to access more than 254 different locations (that are each represented by devices) through a single system. For example, an iSeries may attach to a System/390®, connected to hundreds of systems that the local iSeries would like to communicate with (through System/390). Without APPN virtual controller support, this communication requires the definition of parallel transmission groups (multiple controller descriptions) between the local system and System/390. Using multiple real controller descriptions can be costly in regards to both the line costs and managing multiple connections. With APPN virtual controller support, you use one real controller description, but attach more than 254 devices that are spread across more than one virtual controller.

- Error recovery minimized

APPN virtual controller descriptions do not associate with any communication lines or adjacent system. Thus, there are no *communication failures* to associate with these controller descriptions. This situation highlights some key points regarding error recovery:

When APPN virtual controller descriptions are not used, device descriptions attach to APPN controller descriptions that represent connections to adjacent systems. When communication failures occur, applications that are affected by the session outages must be notified. The system also performs error recovery on the controller description and all of the attached device descriptions. In some large environments, device error recovery can take a lot of time.

When APPN virtual controller descriptions are used, the APPN controller descriptions that represent connections to adjacent systems do not have device descriptions attached. When communication fails (for example, a line failure), the applications affected by the session outages are notified. The system recovers errors on the controller description. No error recovery is required on the device descriptions if each of the following are true:

- The device descriptions are attached to the APPN virtual controller description.
- The APPN virtual controller descriptions are not marked as inoperative.

Eliminating error recovery at the device level can help decrease the amount of time iSeries requires to recover errors after some communication failures.

For more information about getting optimal performance from your network, see the page [Designing an APPN and HPR network](#).

Fine-tune configuration parameters for APPC performance

The setting of certain parameters affect the communication performance of the iSeries. To fine-tune your advanced program-to-program communications (APPC) performance, you can change the values for the following parameters:

- “Maximum length request/response unit size (MAXLENRU) parameter”
- “Maximum frame size (MAXFRAME) parameter” on page 85
- “Pacing (INPACING, OUTPACING, MAXINPACING) parameters” on page 85
- “Transmission priority (TMSPTY) parameter” on page 86

For more information about iSeries communications, see [Communications Configuration](#). 

Maximum length request/response unit size (MAXLENRU) parameter

The maximum length of a systems network architecture (SNA) request/response unit (RU) can be specified with the MAXLENRU parameter in a mode description for APPC, APPN, and HPR.

If you select a value of *CALC for the MAXLENRU parameter, the system selects an efficient size that is compatible with the frame size that you choose. (The frame size is on the line description command.) Many newer input/output processors support IOP assist. Changing the RU size to a value other than *CALC may negate this performance feature.

In most situations, the use of the *CALC value for the MAXLENRU parameter gives you the optimal RU size. If *CALC is not used, consider the following situations when deciding on the appropriate value:

- Choose an RU size that is slightly less than the maximum frame size or a multiple of the maximum frame size. This setting ensures that the largest possible frame size transmits all the time.
- For frame relay, use RU sizes that; when combined with your packet size and protocol, minimize communications costs.
- For token-ring, Ethernet, and wireless network users, use a large RU size that is slightly less than a multiple of the frame size.
- For X.25, optimal values are from 241 through 32768. Pacing values must be coordinated when considering performance with the MAXLENRU parameter.
- For synchronous data link control (SDLC), do not change the *CALC value on the MAXLENRU parameter.

For more information about iSeries configuration, see Communications Configuration. 

Maximum frame size (MAXFRAME) parameter

The maximum frame size is specified in the MAXFRAME parameter in the line and controller descriptions. Larger frame sizes generally supply better performance. Large frame sizes may not work well for error-prone lines or networks because longer times are required to transmit large frames when errors are encountered.

For each line type, set these maximum frame sizes in the line description.

To take advantage of these large frame sizes, these values must be configured correctly. The MAXFRAME parameter on the line description and controller description must reflect the maximum value.

Note: For X.25, increase the DFTPFSIZE parameter value and MAXFRAME parameter value to its maximum value.

Having configured a large frame size does not negatively affect performance for small transfers. Note that both the server and the other link station must be configured for large frames. Otherwise, the smaller of the two maximum frame size values are used in transferring data. Bridges may also limit the frame size.

Note: In order to run HPR, MAXFRAME must be set to at least 768.

For more information about iSeries communications, see Communications Configuration. 

Pacing (INPACING, OUTPACING, MAXINPACING) parameters

Pacing is required if there is a possibility of overflowing data buffers internal to the controller or the host system. This typically occurs if the controller or host must pass the data to a device that operates at a slow speed. If the host system receives a pacing response, it sends more data frames up to the window size to the controller.

- | • Pacing determines how many message units (SNA RUs) can be transferred over a session before receiving an acknowledgment from the receiving system. An excessive number of pacing responses may adversely affect network performance. However, the absence of pacing can cause network congestion and unfair utilization of iSeries resources (buffers and central processing units). The values that you can use in negotiating the pacing values with the adjacent system are determined from the INPACING and OUTPACING values on the mode description. The iSeries will not allow these values to be negotiated to a higher value. If necessary, the receive pacing value negotiate to a lower value, matching the INPACING value.

- The pacing value is determined at session establishment time and is not changed for the duration of the session for the following reasons:
 - The adjacent system does not support adaptive pacing
 - The transmission priority is low priority
- If the adjacent system does support adaptive pacing, the minimum pacing value is set at session establishment time using the INPACING and OUTPACING values. The location that starts the session establishment (BIND request) is responsible for setting the values. No negotiation of the values is performed. However, support is provided by the system to change or adapt the pacing values based on the system's buffer resources and traffic patterns in the network. The system can now allocate its session buffers automatically to efficiently use its available resources. The MAXINPACING parameter defines the upper limit on the number of session buffers. The default value of *CALC sets an upper limit of 2 for the INPACING value.
- The iSeries system also has the ability to slow down the transfer of data or even stop receiving at any node of any session. This allows for more equity in the network by dynamically turning the flow of messages on to any hop for any session that may be contributing to congestion problems. In general, the value of the INPACING, OUTPACING, and MAXINPACING parameters on the mode description can affect the data rate, network congestion, buffer utilization, and central processing unit (CPU) utilization.

Transmission priority (TMSPTY) parameter

The transmission priority (TMSPTY) parameter is on the class-of-service (COS) description. When you create a class-of-service description, you can define one of three transmission priorities for each class of service. You can specify, by the transmission priority (TMSPTY) parameter, that the transmission priority for any class of service is high, medium, or low.

The session activation request carries the transmission priority you specify when a session is established. This allows each logical unit on the session and each routing entry along the session path to store the same transmission priority. You can ensure better response time for the applications that require it by assigning an appropriate mode (which includes a class of service) at session activation time.

Note: Generally, interactive traffic should have a high priority and batch traffic a low priority.

APPC, APPN, and HPR security

The following are some aspects of security for iSeries systems communicating with each other using APPC, APPN, and HPR:

- **General security considerations:**

Consider the following measures when securing your network:

Note: The following password considerations only apply if password protection is not active.

1. When application program security is used, specify SECURELOC(*VFYENCPWD). This means that you only get to log on if BOTH your user profile name AND password are the same on both systems.
2. The person responsible for network security ensures that each user has a unique user ID throughout the network.
3. Have your system administrator set a limit on the number of consecutive password attempts that are not valid for a given display device. When this limit is reached, the device is then varied off. Set the limit with the system value QMAXSIGN. This is only true for Display devices, not for APPC devices.
4. Users can sign on to more than one iSeries system with the same profile. To limit the user profile to one sign-on, Set the system value (*SYSVAL) for LMTDEVSSN parameter on either the Create User Profile (CRTUSRPRF) or Change User Profile (CHGUSRPRF) command.

- **Physical security considerations:**

You are responsible for the physical security of your system when you specify *NONE for the location password (LOCPWD) parameter during APPC configuration. In this case, the iSeries system does not validate the identity of a remote system when a session is being established. However, you can still use application-level security if the remote system supports it. For example, if the remote system is an iSeries system with security level 20 or above. Security needs to be consistent across all the systems in a network if intersystem access is to be controlled and yet not unnecessarily restricted.

- | For more Information about security, review the following topics:
- | • “Session-level security for APPN and HPR”
- | • “Protect your system in an APPN and HPR environment”

For a more complete discussion of security considerations, see Plan and set up iSeries security.

Session-level security for APPN and HPR

Session-level security is achieved by specifying a password on the LOCPWD parameter during configuration. The iSeries system uses the password to validate the identity of the remote system during session establishment. The password must match the password specified on the remote system, or the connection is not allowed.

If the remote system does not support session level security (Series/1 RPS version 7.1, CICS/VS release 1.6):

- Specify LOCPWD(*NONE) to establish the connection, and provide the necessary physical security

There is a security concern when you create device descriptions with APPN(*YES), and when APPN automatically creates and varies on a device description with the same remote network ID, location name, and local location name as the APPN remote location configuration list entry. To compensate for remote locations using an independent device description with APPN(*YES):

- Add an entry to the APPN remote location configuration list that includes security information

Note: In order to avoid using security information that cannot be predicted, ensure that all the device descriptions, as described above, contain exactly the same security information.

Protect your system in an APPN and HPR environment

APPN networks provide open connectivity, and require minimal configuration by each system in the network. When a system has a connection into an APPN network, it can establish sessions with other systems that are connected within that APPN network.

APPN reduces the physical, configuration barriers to communications. However, you might want to build some logical barriers between systems in the network for security reasons. This ability to control which systems can connect to yours is often called **firewall support**. Network administrators might use a variety of node types to specify which connections between APPC locations are allowed. For example, you might want to allow SYSTEMB to communicate with SYSTEMA and SYSTEMD, but not with SYSTEMC. For an explanation of this, an example, and more information, see the following topics.

- “APPN filtering support”
- “Create a session endpoint filter” on page 89
- “Class of service (COS) routing” on page 90

APPN filtering support

Before we discuss APPN filtering support, an explanation of node types in an APPN network is needed:

- A **peripheral node** is at the edge of a network. It can participate in the network, but it cannot provide intermediate routing to other systems in the network. A peripheral node can be an **end node (EN)** such as MADISON and PARIS in the figure below. A peripheral node can be a **low-entry networking node (LEN)**, such as CHICPC1 and CHICPC2. A peripheral node can also be a network node in a different network (NETID). From CHICAGO’s perspective, LONDON is a peripheral node.

- A **network node (NN)** provides routing services among systems in the network. In CHICAGO, and ATLANTA are examples of network nodes.
- A **Branch Extender** node is an extension to the APPN network architecture that appears as a network node (NN) to the Local Area Network (LAN), and as an end node (EN) to the Wide Area Network (WAN). This reduces topology flows about resources in the LAN from being disconnected from the WAN.

APPN filtering support provides the ability to create a firewall that is based on APPC location names. You use two different types of filter lists:

- A **session-endpoint filter** controls access to and from a location. For example, in the session endpoint filter on the CHICAGO system in the figure below, it specifies which locations can establish a session with CHICAGO or with PAYROLL. CHICAGO and PAYROLL are two different locations on the CHICAGO system.

Similarly, the session endpoint filter on the MADISON system specifies which locations can establish a session with the MADISON location.

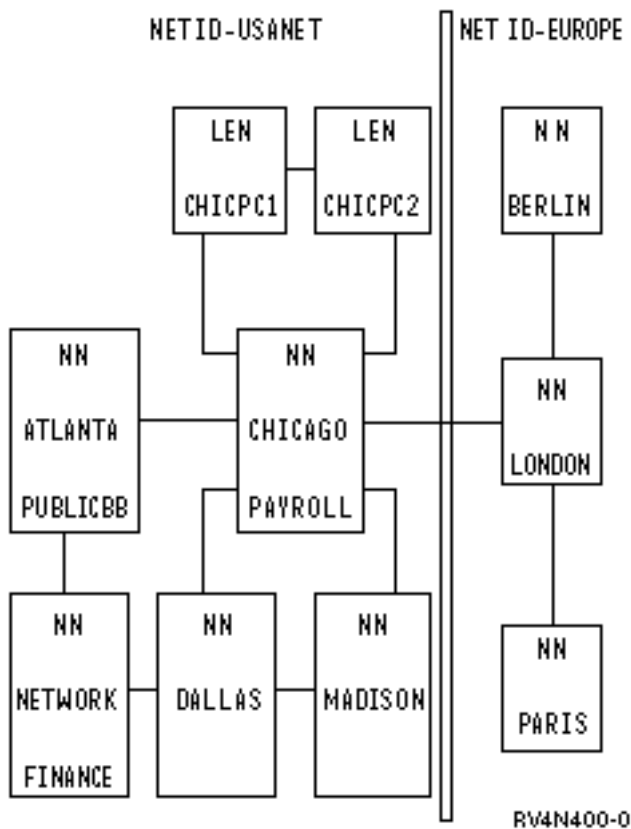

Figure 11. Two connected APPN networks

On iSeries, you can use the new QAPPNSSN configuration list, by itself or in conjunction with the QAPPNRMT configuration list, to create a session endpoint filter.

- A **directory search filter** on a network node determines the following for its associated peripheral nodes:
 - Access **from** the peripheral node (when the peripheral node is the requester). For example, in you can use the directory search filter on LONDON to control the possible destinations for users on the PARIS system. Similarly, you can use the directory search filter on CHICAGO to control the possible destinations for users on CHICPC1 and CHICPC2.
 - Access **to** the peripheral node (when the peripheral node is the destination). In for example, you can use the directory search filter on CHICAGO to determine which locations can access CHICPC1.

Because both CHICAGO and DALLAS provide connections to MADISON, you must set up the directory search filters on both CHICAGO and DALLAS to restrict connections to MADISON.

Similarly, you can use the directory search filter on CHICAGO to specify which USANET locations are permissible destinations for EURONET users.

To create a directory search filter use the QAPPNDIR configuration list.

Create a session endpoint filter

The following are two different methods for creating a session endpoint filter on the CHICAGO system in the figure below. They must satisfy the following requirements:

- Only the FINANCE location can establish a session with the PAYROLL location.
- The CHICAGO location can communicate with any USANET location except PAYROLL.
- The CHICAGO location can communicate with LONDON.

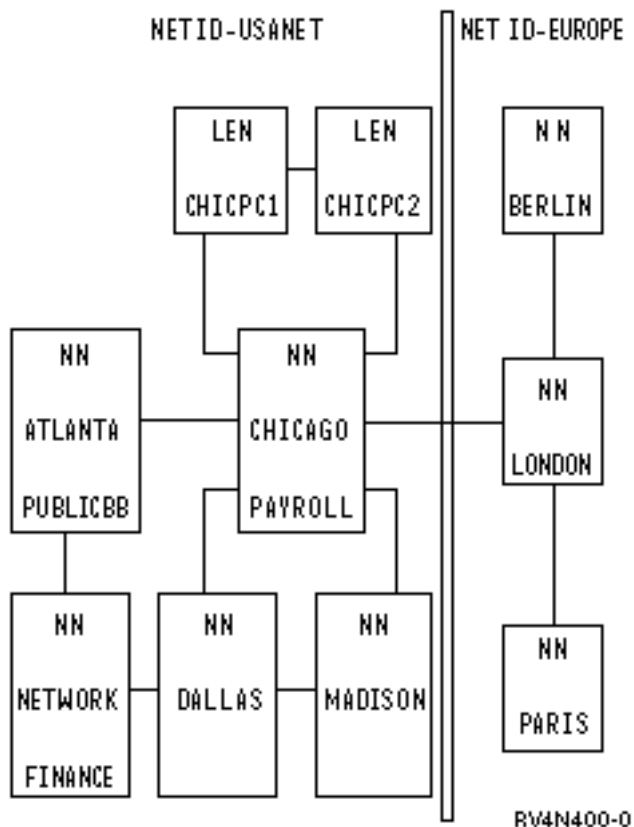

Figure 12. Two connected APPN networks

- **Using the QAPPNSSN and QAPPNRMT configuration lists together:**

The most secure method for creating a session endpoint filter is to use the QAPPNSSN configuration list and the QAPPNRMT configuration list together. The QAPPNRMT configuration list provides password security between systems, which helps to protect from an imposter system (a system or user that is pretending to be another system).

When you use this method, you create the QAPPNSSN configuration list that does not specify any remote locations. It points to the QAPPNRMT configuration list.

The drawback to this method is that you must explicitly define each location pair on the QAPPNRMT configuration list. If you want the CHICAGO location (which is on the same system as the PAYROLL location) to communicate with other locations, you need to add an entry for each pair.

- **Using the QAPPNSSN configuration list by itself:**

When you specify remote locations in the QAPPNSSN configuration list, your configuration task is simpler because you can use generic names and wildcard entries. However, when you use this method, you do not have the protection of password verification between locations. In addition, when you use generic names and wildcards, the system might accept or reject requests in a different way than you intended.

Class of service (COS) routing

Network nodes maintain information about all network nodes and links between network nodes. When a session is requested, a mode is specified. Each node contains a class of service (COS) parameter that specifies the class of service description that will be used to calculate the route the session will take. The class of service also specifies the transmission priority that will govern the rate of data transfer after the session has been established.

The following class-of-service descriptions are shipped with the iSeries system:

- #CONNECT: the default class of service
- #BATCH: a class of service that is tailored for batch communications
- #BATCHSC: is the same as #BATCH except that a data link security level of at least *PKTSWTNWK is required
- #INTER: a class of service that is tailored for interactive communications
- #INTERSC: is the same as #INTER except that a data link security level of at least *PKTSWTNWK is required

If you need to force a particular route to be selected, a user class of service (COSD) can be created. See “Create a class-of-service description” on page 11 for a thorough explanation.

Troubleshooting APPN and HPR

If an error log indicates that the route to the remote location cannot be found, the Start Pass-Through (STRPASTHR) command attempts to make the connection again. The STRPASTHR command has built-in detailed diagnostic capabilities that exceed those provided by other interfaces that use APPN, or HPR networks. These diagnostic capabilities include problem analysis, functions for problem and error logging (including directory services search information), and route calculation information. However, the system records all session initiation errors in the error log.

When a STRPASTHR command fails to contact a remote location in an APPN network, a record is written to the problem log. The record is written if there is an associated problem record for analyzing the data. The Work with Problems (WRKPRB) and Analyze Problem (ANZPRB) commands enable you to examine and interpret the problem log to help you isolate the problem.

The Display APPN Information (DSPAPPNINF) command can help you understand the topology of your network. It displays the names of all known remote control points and their locations, intermediate sessions, and link status information. The Work with APPN Status (WRKAPPNSTS) command provides session-related information for advanced program-to-program communications (APPC) controller descriptions. These controller descriptions represent connections to adjacent systems by using Advanced Peer-to-Peer Networking (APPN), or high-performance routing (HPR).

If no problem record exists for a particular type of error, the system does not record a message in the problem log. However, the system records all errors in the error log. The error log entry may help your service personnel isolate the problem.

If you have a communication problem specifically related to APPN and HPR running over your system, reviewing the following topics might also help in troubleshooting:

- Solve remote communication problems using STRPASTHR
- Solve communication problems using DSPAPPNINF
- Solve communication problems using WRKAPPNSTS

- Solve communications problems using communications trace
- Solve communication problems using session activity
- Finding System Network Architecture sense codes
- APPN error log data

Solve remote communication problems using STRPASTHR

When you encounter problems indicating the route to the remote location cannot be found, you can attempt to make the connection again. Use the Start Pass-Through (STRPASTHR) command to assist in troubleshooting. The STRPASTHR command has built in diagnostic capabilities that exceed those that are provided by other interfaces that utilize APPN networks. These diagnostic capabilities include problem analysis, problem logging, and error logging functions.

When a STRPASTHR command fails to contact a remote location in an APPN network, a record is written to the problem log. This occurs only if there is an associated problem analysis for analyzing the data. The Work with Problems (WRKPRB) and Analyze Problem (ANZPRB) commands enable you to examine and interpret the log to help you isolate the problem.

When a start pass-through attempt has failed, an error log is issued. You can use these error logs to assist in troubleshooting your communication problem. See APPN error log data for more information.

Solve communication problems using DSPAPPNINF

Isolating a routing problem in an Advanced Peer-to-Peer Networking (APPN) network can be challenging. You can view the APPN information to assist you in understanding the topology of network nodes and some of their locations.

To display APPN Information, type the command DSPAPPNINF on a command line and press F4. You can also select option 6 (Display APPN information) on the Network Management menu.

The information the system displays, prints, or stores depends on the options you select. The system displays additional options that are based on previous options that are selected.

See the following scenario for help in using the DSPAPPNINF command:

- Type DSPAPPNINF *TOPOLOGY on System A.
 - Type 5 next to System A to display the Display Link Destination Nodes display.

The Display Link Destination Nodes display identifies how this node's topology database looks. The link Active Column identifies whether APPN will consider the link in route computation. If a link Active column value is No, this indicates the link will not be included in APPN route selection.
 - Next type a 5 to Display Link Characteristics. This information along with the information from the Display Network Attributes (DSPNETA) command identifies the transmission group (TG) values and node values.

With this information, you can determine why a path is taken or why one is not being taken for the class of service (COS).
- If you type, DSPAPPNINF *LCLNODE on System A,

This allows you to determine what locations are known by the local node. It shows locations that are configured on the local node and locations that are found by previous searches.
- If you type, DSPAPPNINF *SSN on System A,

This allows you to look at up to 200 endpoint sessions that were successfully established since the last IPL. You can also see the route that was taken by that session, error data, session start BIND, end time, pacing that is used, and others.
- If you type, DSPAPPNINF *SSN SSNTYPE(*INMSSN) on System A,

This allows you to determine whether active sessions are routed through the local system. You may, for example, want to vary off a controller, but need to know whether it is being used for intermediate sessions. You can also see which controller descriptions are associated with an intermediate sessions.

Solve communication problems using WRKAPPNSTS

The Work with APPN Status (WRKAPPNSTS) command provides session-related information for advanced program-to-program communications (APPC) controller descriptions running Advanced Peer-to-Peer Networking (APPN), or high-performance routing (HPR). The controller descriptions represent connections to adjacent systems. You use the WRKAPPNSTS command to provide the following information about APPN controller descriptions:

- The system shows all the location pairs that have one or more sessions over the controller description. The session activity is not limited to those sessions in which the local system is the source, or target of the session. Information about APPN intermediate sessions and cases when the local system is performing the APPN, or HPR boundary function, are also provided.

Note: Automatic Network Routing (ANR) traffic is not shown.

- You can display session information for the location pairs that are associated with a controller. The session information provides a tie between a particular session and the device description the system uses. For example, a device description attached to the real controller description is shown, or an APPN virtual controller description is shown.
- You can display information about Rapid Transport Protocol (RTP) connections that either originate, or end on the local system. It is also possible to see the location pairs and session information associated with the sessions that are carried over the RTP connection.
- You can display the route that a particular RTP connection has taken through an HPR subnet.
- You can request the system perform some operations against these RTP connections. These operations include requesting the system to perform a non-disruptive path switch, and ending an RTP connection that is currently active. You can issue both of these operations against one of the following:
 - A single RTP connection
 - All of the RTP connections that have the first hop of their route across the controller description being displayed

Solve communications problems using communications trace

Communications trace can capture HPR data running over IP networks, allowing you to troubleshoot Enterprise Extender communications problems. It is a service function that allows the data that flows over a communications line, such as a local area network (LAN) or wide area network (WAN), to be captured for analysis. For more information about communications trace, see Communications trace in the TCP/IP troubleshooting topic.

Solve communication problems using session activity

Viewing session activity, or actual work that occurs between the local system and adjacent systems allows you to view network attributes, mode, class-of-service (COS), and topology information. You might want to see information about the session activity for any of the following reasons:

- Activity occurs over the controller descriptions to adjacent systems
- When certain sessions are established over a connection that the operator did not expect
- The optimal route is no longer operating:

To find another route for the session, you may need to know what location pairs are using for a particular connection. If you have to change the route for any session, you might need to vary off the controller description. Before varying off controller descriptions, you can do the following:

- Determine whether any active sessions are using that connection (so you can notify the affected users of the upcoming outage)
- Delay the varying off of the controller description

For more information about session activity, see “Solve communication problems using WRKAPPNSTS.”

Finding Systems Network Architecture sense codes

Systems Network Architecture (SNA) sense codes contain additional information for the system programmer, and system support personnel about the error, or problem that has occurred on the

network. When you need to find an explanation for any SNA sense codes, see the SNA Formats book (publib.boulder.ibm.com/cgi-bin/bookmgr/BOOKS/D50A5007).

APPN error log data

This page defines the APPN session setup data that is supplied when an error log is issued for a start pass-through failure. This failure results in message CPF8933 (*Route to specified location not found*) being issued to the user's workstation. The following information should be used for error log entries with the reference codes 7100 and 7101.

Note: Use the Work with Problems (WRKPRB) command for error log entries with the reference code 7102.

For a detailed description of APPN error log data, review the following pages:

- Standard APPN diagnostic data
- APPN session setup states
- Optional APPN diagnostic data

Standard APPN diagnostic data

The table below defines the format of APPN error log entries. The information available in the error log depends on how far the session initiation attempt had proceeded when the failure or time-out occurred.

Table 3. APPN Error Log Data

Byte	Bit	Content
Session Setup Control Information		
0-3		Length of entire APPN error log structure
4-15		Reserved
16-17		Reserved
18-19		Time out session setup state (available if session failed due to time-out)
1A-21		Reserved
22		Flag bits
	0	Local system node type (0 = end node and 1 = network node)
	1	Session setup request should no longer be tracked
	2	A final session state has been reached
	3-7	Reserved
Pre-search Phase Data		
23		Pre-search phase data measurements
	0	Pre-search phase data is valid to look at because some of the fields have been filled in
	1-7	Reserved
24-2B		Local location name
2C-33		Remote location name
34-3B		Remote network identifier
3C-43		Mode name
44-4D		Device description name
4E-57		Controller description name
58-71		PCID (procedure correlation identifier)
72-79		Class-of-service name

Table 3. APPN Error Log Data (continued)

Byte	Bit	Content
Common Information During Search Phase		
7A		Common information during search phase
	0	Common information data is valid to look at because some of the fields have been filled in
	1	Wildcard entry was used to satisfy search
	2-7	Reserved
7B-82		Network identifier for the destination node
83-8A		Control-point name for the destination node
8B-92		Network identifier for the network node server of the destination node
93-9A		Control-point name for the network node server of the destination node
9B-9E		Reserved
9F-A6		The network identifier of the remote location that was found using the *ANY directory entry
A7-AE		The control-point name of the remote location that was found using the *ANY directory entry
AF-B6		The network identifier of the network node server of the remote location that was found using the *ANY directory entry
B7-BE		The control-point name of the network node server of the remote location that was found using the *ANY directory entry
Directory Search Summary Information - End Node		
BF		Directory search summary information - end node
	0	End node search information is valid to look at because some of the fields have been filled in
	1	Search type (0 = local only search and 1 = distributed search)
	2	Real indicator supplied by the network node server
	3	Default indicator supplied by the network node server - note that the real and default server-supplied indicators are mutually exclusive
	4-7	Reserved
C0-C7		Network identifier of the network node server for the local system
C8-CF		Control-point name of the network node server for the local system
Directory Search Summary Information - Network Node		
D0		Network node directory steps processed indicators
	0	Network node search information is valid to look at because some of the fields have been filled in
	1	Query topology database for a network node control-point name
	2	Location found in local directory database
	3	One hop search sent to an attached end node
	4	Route selection attempted for a directed search to a network node
	5	Directed search sent to network node
	6	Reserved
	7	Reserved
D1	0	Domain broadcast sent

Table 3. APPN Error Log Data (continued)

Byte	Bit	Content
	1	Broadcast search sent
	2	Reserved
	3	Reserved
	4-7	Reserved
D2-D9		Directed search target network identifier
DA-E1		Directed search target control-point name
E2-E9		Reserved
EA-F1		Reserved
F2-F9		Reserved
FA-101		Reserved
Switched Link Activation		
102	0	Link activation data is valid to look at because some of the fields have been filled in
	1-7	Reserved
103-10A		First hop of the route network identifier (real node)
10B-112		First hop of the route control-point name (real node)
113-11A		First hop of the route network identifier (virtual node)
11B-122		First hop of the route control-point name (virtual node)
123		Transmission group number for first hop of route
124-12D		Line description name
12E-131		Reserved
132-133		Reason code for error
Generic Session Setup Information		
134-137		Sense code returned
138-15D		Past session setup states
15E-15F		Current [®] session setup state
160-17F		Reserved
180		Variable data area (see "Optional APPN diagnostic data" on page 99)

Note: 0=false and 1=true on the bit fields, unless otherwise specified.

APPN session setup states

The following table presents the possible session setup states for APPN while it processes a session initiation request. One of these values always resides in the current session setup state.

Table 4. APPN Session Setup States

State	Reason
1000	Session setup complete. An existing session will be used; therefore, APPN control point functions will not be called.
1015	Session setup request has failed. Refer to sense code for details.
1020	Session setup rejected. The local location name chosen is not defined in either the network attributes or as a local location list entry.
1025	Session setup rejected. Mode name specified is not defined on the system.

Table 4. APPN Session Setup States (continued)

State	Reason
1030	Session setup request has been sent by location manager to resource manager to obtain a device.
1032	Session setup request cannot be satisfied with a non-APPN device or with an existing APPN session. The APPN control point has been called to establish a new session.
1035	Session setup has been pended because of a previous request that is waiting for the request transmission group vectors processing to complete.
1040	Session setup has been pended because of a previous request that is still waiting for the route selection phase (request single hop route - end node) to complete.
1050	Session setup has been pended because of a previous request that is still waiting for the route selection phase (request route - network node) to complete.
1060	Session setup has been pended because of a previous request that is still waiting for the switched link activation phase to complete.
1070	Session setup has been pended because of a previous request that is still waiting for the location search phase to complete.
1080	A request transmission group vectors request is outstanding to topology routing services component.
1082	A request transmission group vectors request is being processed by topology routing services component.
1084	The request transmission group vectors response was returned by the topology routing services component.
1086	The request transmission group vectors request has been received by session services.
1090	Location search phase request is outstanding, but has not yet been received by the local system's directory services function.
End Node Location Search Phase (2000 - 2999) States	
2000	The local system's directory services has received the search request and has begun its processing.
2010	There is a one hop search request outstanding to the local system's network node server.
2020	Location search processing has been completed by the local system's directory services.
2025	Session services has received the locate message response from directory services.
2030	Location search phase has failed. The owning control point for the remote location can not be determined during the search phase. In this case, the search was forwarded to our network node server and the location can not be found.
2040	Location search phase has failed. The owning control point for the remote location can not be determined during the search phase. In this case, the search was not sent out of the local system because of no network node server, and there was no network node that the local system can forward the bind to.
2050	Location search phase has failed. The network node server has sent an SNA negative response indicating that the route selection control vector (RSCV) required is larger than 255 bytes.
2060	Location search phase has failed. The network node server has sent an SNA negative response indicating that the class-of-service is not valid.
2070	Location search phase has failed. The network node server has sent an SNA negative response indicating a route-not-available condition.
Network Node Location Search Phase (3000 - 3999) States	
3000	The local system's directory services has received the search request and has begun its processing.
3010	Query control-point name outstanding. A request to determine if the remote location is the name of a network node control point in the topology database is outstanding.
3012	Query control-point name request is being processed by topology routing services.
3014	Query control-point name response has been sent by topology routing services.

Table 4. APPN Session Setup States (continued)

State	Reason
3016	Query control-point name response has been received by directory services.
3020	One hop search request is outstanding to an attached end node.
3030	A request for a route is outstanding to topology routing services so that a directed search can be sent to another network node.
3032	Request route for directed search is being processed by topology routing services.
3034	Request route response for directed search has been sent by topology routing services.
3036	Request route response for directed search received by directory services.
3040	A directed search request is outstanding to another network node.
3050	A request for a route is outstanding to topology routing services for a remote search.
3052	Request route for a remote search is being processed by topology routing services.
3054	Request route response for a remote search has been sent by topology routing services.
3056	Request route response for a remote search was received by directory services.
3060	A routed search request is outstanding to a network node.
3070	A domain broadcast is currently being run. This involves querying attached end nodes or network nodes in another network to determine if the location is known by that system.
3080	A broadcast search is outstanding to one or more directly attached network nodes (this might involve attached network nodes that have access to multiple networks).
3090™	A request for a route is outstanding to topology routing services to determine if a node that can access multiple networks exists so that it can determine where the remote location exists.
3092	Request route for a node that can access multiple networks is being processed by topology routing services.
3094	Request route response for a node that can access multiple networks has been sent by topology routing services.
3096	Request route response for a node that can access multiple networks was received by directory services.
3100	A search request is outstanding to a node that can access multiple networks.
3110	A request is outstanding to the session services component in order to perform functions necessary to send searches into a different APPN network.
3120	The location search phase has completed and a response has been returned by directory services.
3125	The location search phase has completed and the response has been received by session services.
3130	The location search phase has failed.
Route Selection Phase (4000 - 4999) States	
4000	A request for a single hop route is outstanding to the topology routing services component.
4002	The request for a single hop route is being processed by topology routing services.
4004	The request single hop route response has been returned by topology routing services.
4006	The request single hop route response has been received by session services.
4010	A request single hop route failure has occurred.
4030	A request for a route is outstanding to the topology routing services component.
4032	The request for a route is being processed by topology routing services.
4034	The request route response has been returned by topology routing services.
4036	The request route response has been received by session services.
4040	The request for a route has failed. The class-of-service name being used is not defined on the local system.

Table 4. APPN Session Setup States (continued)

State	Reason
4050	The request for a route has failed. The route selection control vector required to satisfy the end-to-end route is larger than the architected limit (255 bytes).
4060	The request for a route has failed. Route-not-available condition has been detected. No destination network nodes or virtual nodes are available for intermediate routing.
4062	The request for a route has failed. Route-not-available condition has been detected. A route that satisfies the user class-of-service but which uses inactive transmission groups does exist.
4064	The request for a route has failed. Route-not-available condition has been detected. A route that has active transmission groups but which does not meet the class-of-service requirements does exist.
4066	The request for a route has failed. Route-not-available condition has been detected. A route that has active transmission groups but which does not meet the class-of-service requirements does exist. A route that satisfies the user class-of-service but which uses inactive transmission groups also exists.
4068	The request for a route has failed. Route-not-available condition has been detected. Destination intermediate routing nodes exist, but no route of any type can be calculated.
4080	Session setup failure. The controller description that represents the first hop of the route is unknown by the local system.
Switched Link Activation Phase (5000 - 5199) States	
5000	The request to activate the switched link is currently outstanding from session services.
5005	Configuration services has begun processing the activate route request but has not yet completed its processing.
5010	The activate route has completed, but some failure has occurred. Details are based on sense code.
5020	The request to activate the switched link has been pended. A controller description is being created or varied on for establishing a link using the connection network.
5030	The request to activate the switched link has been pended. The controller is not allowed to make a connection in this state. The probable cause is a message outstanding for this controller description.
5040	The request to activate the switched link has been pended. Configuration services is waiting for the operating system to issue the command to activate the switched connection.
5050	The request to activate the switched link has been pended. The attempt to select an eligible line description for this request has failed. The probable cause is a message that is outstanding requiring operator intervention.
5070	The request to activate the switched link has been pended. The system is currently in the process of establishing an outgoing connection.
5080	The request to activate the switched link has been pended. The outgoing connection has been made, but the exchange identification phase is in progress.
5090	The request to activate the switched link has been pended. The outgoing connection or exchange identification phase has failed. The system is waiting for the operator to respond to a message.
5100	The switched link activation has completed successfully.
5110	The session services component has received its response to its switched link activation request.
Non-Switched Link Activation Phase (5200 - 5299) States	
5200	Session services is waiting for configuration services to complete the non-switched link activation.
5210	The non-switched link activation phase has completed successfully.
HPR Route Setup Phase (5300 - 5399) States	
5300	A request to determine whether a session should be carried over an RTP connection is outstanding.
5310	The request to determine if an RTP connection should be used for the session has detected an error.
5315	An HPR Route Setup request is outstanding.
5320	The HPR Route Setup request was returned with a good completion.

Table 4. APPN Session Setup States (continued)

State	Reason
5325	The HPR Route Setup request has failed.
5330	The HPR Route Setup phase has completed successfully.
APPN Virtual Controller Selection Phase (5400 - 5499) States	
5400	The request is outstanding to the virtual controller manager component to find the APPN virtual controller description.
5490	The request to find the APPN virtual controller description has failed.
5495	The request to find the APPN virtual controller description has completed successfully.
Device Selection Phase (6000 - 6999)	
6000	A request is outstanding to the T2 station input/output manager (IOM) task to select a device.
6005	The T2 station input/output manager (IOM) task has begun processing the get device request.
6010	Device selection pended. The device was found, but it is in the process of being automatically varied on.
6020	Device selection pended. No device was found; therefore, a new device is in the process of being created and varied on.
6025	Device selection request pended. A dynamic device creation or vary on is already in progress for a previous get device request or for a received bind request.
6030	The device selection has failed. Refer to the sense data returned for an explanation of this failure.
6040	The device selection phase was completed successfully by the T2 station input/output manager (IOM) task.
6045	The device selection response was received by session manager.
6050	APPN session manager processing is complete.
6060	The session setup has completed successfully.

Optional APPN diagnostic data

The optional APPN diagnostic data is presented in a format similar to the format of a control vector. This data is located after the standard APPN diagnostic data. More than one type of variable data can be present. The type of optional data that is contained in the error log depends on the current session setup state at the time the error or time-out occurred. This data begins at offset X'0312' from the start of the error log entry.

Header information exists at the beginning of each variable data element. This provides the length and key value of the data area element (similar to the way that control vectors are structured).

Search-Sent Elements: This structure defines a search-sent information element. Multiple elements may be supplied. The header information length is used to determine the length of a single element. At times, only specific search types and search results are supplied. These are performed for the session setup state domain broadcast (3070) and broadcast search outstanding (3080). At other times, all the searches that are sent and their results are supplied in the search failure (3130) session setup state.

Table 5. Search-Sent Information Elements

Byte	Hex Value	Content
Header Information for Variable Data		
0		Length of this type of variable data
2	X'01'	Key value for a search-sent element
Variable Data		
3		Network identifier of the system searched

Table 5. Search-Sent Information Elements (continued)

Byte	Hex Value	Content
0B		Control-point name of the system searched
13		Search type
	X'00'	No search sent
	X'01'	Search type is single hop
	X'02'	Search type is directed to a network node control point
	X'03'	Domain broadcast
	X'04'	Network broadcast
	X'05'	Directed for remote search
	X'06'	Directed to a node that can access multiple networks
14		Node type
	X'01'	End node
	X'02'	Network node
	X'03'	Control point resides in a network with a different network identifier
15		Search results
	X'00'	Search response not received
	X'01'	Positive explicit response
	X'02'	Positive *ANY response
	X'03'	Negative response
16		Sense code

Regular Route Selection Control Vector (RSCV) 46: The regular structure is used for an RSCV consisting of X'46' control vectors. It is used in BIND processing.

The route selection control vector (RSCV) is carried in BIND, RSP(BIND), and other RUs. It describes the path through an APPN network that a session is to take or has taken. The RSCV is sent and received by APPN nodes, but not by LEN nodes.

Table 6. Routing Information RSCV 46

Byte	Hex Value	Content
Header Information for Variable Data		
0		Length of this type of variable data
2	X'02'	Key value for routing information (RSCV 46) variable data
Variable Data		
3		RSCV length
4		RSCV key = X'2B'
5		Maximum hop count: the binary number of the transmission group descriptor or network name.
6		Current hop count: the binary index number of the last transmission group descriptor control vector.
7-n		Control vectors
	X'46'	Transmission group descriptor control vector: one for each transmission group on the session path (present when the RSCV is carried on a BIND or RSP(BIND)).

Regular Route Selection Control Vector (RSCV) 0E: The regular structure is used for an RSCV consisting of X'0E' control vectors. It is used in search processing.

This route selection control vector (RSCV) is carried in search requests through an APPN network. APPN network nodes send and receive the RSCV.

Table 7. Routing Information RSCV 0E

Byte	Hex Value	Content
Header Information for Variable Data		
0		Length of this type of variable data
2	X'03'	Key value for routing information (RSCV OE) variable data
Variable Data		
3		RSCV length
4		RSCV key = X'2B'
5		Maximum hop count: the binary number of the transmission group descriptor or network name.
6		Current hop count: the binary index number of the last transmission group descriptor control vector.
7-n		Control vectors
	X'0E'	Control-point name control vector: one for each control point on the search path

Single Hop Route Failure Element: This structure consists of the partner node for the single-hop-route request and an array of 255 entries that represent the status of particular transmission groups. The single hop route element explains why the entries can not be used.

Table 8. Single Hop Route Information

Byte	Bits	Content
Header Information for Variable Data		
0		Length of this type of variable data
2	X'04'	Key value for routing information variable data
Variable Data		
3		Network identifier of the partner node
B		Control-point name of partner node
13		The 255 entries (1 byte each) that represent the state of the transmission group
	X'00'	Transmission group number not defined
	X'01'	Transmission group is active but does not have the correct class-of-service characteristics
	X'02'	Transmission group is inactive but does have correct class-of-service characteristics
	X'03'	Transmission group is inactive and does not have correct class-of-service characteristics

Ineligible Destination Network Nodes Elements: This structure specifies the reason why a particular transmission group returned by an end node is ineligible for providing access to the APPN network.

Note: There may be multiple elements supplied. The header information length should be used to determine when all elements have been processed. This information may be available for state 4060.

Table 9. No Destination Network Nodes Eligible Information

Byte	Hex Value	Content
Header Information for Variable Data		
0		Length of this type of variable data
2	X'05'	Key value for routing information variable data
Variable Data		
3		Network identifier of the ineligible destination network node
B		Control-point name of the ineligible destination network node
13		Transmission group number of ineligible destination node
14		Reason why transmission group is ineligible
	X'00'	Transmission group number not defined
	X'01'	Transmission group is active but does not have the correct class-of-service characteristics
	X'02'	Transmission group is inactive but does have correct class-of-service characteristics
	X'03'	Transmission group is inactive and does not have correct class-of-service characteristics

Destination Node List: This structure contains a single network-qualified control point name that represents one of the possible destinations (network nodes or virtual nodes) that, during route selection, could not reach.

Note: There may be multiple elements supplied. The header information length should be used to determine when all elements have been processed. This information may be available for states 4062, 4064, 4066, and 4068.

Table 10. Destination Node List

Byte	Hex Value	Content
Header Information for Variable Data		
0		Length of this type of variable data
2	X'06'	Key value for routing information variable data
Variable Data		
3		Network identifier of the destination node
B		Control-point name of destination node
13		Node type
	X'02'	Network node
	X'04'	Virtual node

User Class-of-Service with Inactive Transmission Groups RSCV: This structure is used to represent an RSCV that allows inactive transmission groups. It has the same class-of-service characteristics as the class-of-service that is given by the user.

BIND, RSP(BIND), and other RUs carry the route selection control vector (RSCV) . It describes the path through an APPN network that a session is to take or has taken. APPN nodes send and receive the RSCV , but LEN nodes do not.

Table 11. User Class-of-Service with Inactive Transmission Groups

Byte	Hex Value	Content
Header Information for Variable Data		
0		Length of this type of variable data
2	X'07'	Key value for routing information variable data
Variable Data		
3-4		RSCV length
5		RSCV key = X'2B'
6		Maximum hop count: the binary number of the transmission group descriptor or network name
7		Current hop count: the binary index number of transmission group the last descriptor control vector
8-n		Control vectors
	X'46'	Transmission group descriptor control vector: one for each transmission group on the session path
	X'47'	Transmission group characteristics of control vector: one for each transmission group on the session path (present when the RSCV is carried on a BIND or RSP(BIND))

Any Class-of-Service with Active Transmission Groups RSCV: This structure represents an RSCV that allows active transmission groups, but allows any class-of-service characteristics to be acceptable.

BIND, RSP(BIND), and other RUs carry the route selection control vector (RSCV) . It describes the path through an APPN network that a session is to take or has taken. APPN nodes send and receive the RSCV , but LEN nodes do not.

Table 12. User Class-of-Service with Active Transmission Groups

Byte	Hex Value	Content
Header Information for Variable Data		
0		Length of this type of variable data
2	X'08'	Key value for routing information variable data
Variable Data		
3-4		RSCV length
5		RSCV key = X'2B'
6		Maximum hop count: the binary number of the transmission group descriptor or network name
7		Current hop count: the binary index number of the last transmission group descriptor control vector
8-n		Control vectors
	X'46'	Transmission group descriptor control vector: one for each transmission group on the session path
	X'47'	Transmission group characteristics control vector: one for each transmission group on the session path (present when the RSCV is carried on a BIND or RSP(BIND))

Code license disclaimer information

IBM grants you a nonexclusive copyright license to use all programming code examples from which you can generate similar function tailored to your own specific needs.

| SUBJECT TO ANY STATUTORY WARRANTIES WHICH CANNOT BE EXCLUDED, IBM, ITS
| PROGRAM DEVELOPERS AND SUPPLIERS MAKE NO WARRANTIES OR CONDITIONS EITHER
| EXPRESS OR IMPLIED, INCLUDING BUT NOT LIMITED TO, THE IMPLIED WARRANTIES OR
| CONDITIONS OF MERCHANTABILITY, FITNESS FOR A PARTICULAR PURPOSE, AND
| NON-INFRINGEMENT, REGARDING THE PROGRAM OR TECHNICAL SUPPORT, IF ANY.

| UNDER NO CIRCUMSTANCES IS IBM, ITS PROGRAM DEVELOPERS OR SUPPLIERS LIABLE FOR
| ANY OF THE FOLLOWING, EVEN IF INFORMED OF THEIR POSSIBILITY:

- | 1. LOSS OF, OR DAMAGE TO, DATA;
- | 2. DIRECT, SPECIAL, INCIDENTAL, OR INDIRECT DAMAGES, OR FOR ANY ECONOMIC
| CONSEQUENTIAL DAMAGES; OR
- | 3. LOST PROFITS, BUSINESS, REVENUE, GOODWILL, OR ANTICIPATED SAVINGS.

| SOME JURISDICTIONS DO NOT ALLOW THE EXCLUSION OR LIMITATION OF DIRECT,
| INCIDENTAL, OR CONSEQUENTIAL DAMAGES, SO SOME OR ALL OF THE ABOVE LIMITATIONS
| OR EXCLUSIONS MAY NOT APPLY TO YOU.

Notices

This information was developed for products and services offered in the U.S.A.

IBM may not offer the products, services, or features discussed in this document in other countries. Consult your local IBM representative for information on the products and services currently available in your area. Any reference to an IBM product, program, or service is not intended to state or imply that only that IBM product, program, or service may be used. Any functionally equivalent product, program, or service that does not infringe any IBM intellectual property right may be used instead. However, it is the user's responsibility to evaluate and verify the operation of any non-IBM product, program, or service.

IBM may have patents or pending patent applications covering subject matter described in this document. The furnishing of this document does not grant you any license to these patents. You can send license inquiries, in writing, to:

IBM Director of Licensing
IBM Corporation
North Castle Drive
Armonk, NY 10504-1785
U.S.A.

For license inquiries regarding double-byte (DBCS) information, contact the IBM Intellectual Property Department in your country or send inquiries, in writing, to:

IBM World Trade Asia Corporation
Licensing
2-31 Roppongi 3-chome, Minato-ku
Tokyo 106-0032, Japan

The following paragraph does not apply to the United Kingdom or any other country where such provisions are inconsistent with local law: INTERNATIONAL BUSINESS MACHINES CORPORATION PROVIDES THIS PUBLICATION "AS IS" WITHOUT WARRANTY OF ANY KIND, EITHER EXPRESS OR IMPLIED, INCLUDING, BUT NOT LIMITED TO, THE IMPLIED WARRANTIES OF NON-INFRINGEMENT, MERCHANTABILITY OR FITNESS FOR A PARTICULAR PURPOSE. Some states do not allow disclaimer of express or implied warranties in certain transactions, therefore, this statement may not apply to you.

This information could include technical inaccuracies or typographical errors. Changes are periodically made to the information herein; these changes will be incorporated in new editions of the publication. IBM may make improvements and/or changes in the product(s) and/or the program(s) described in this publication at any time without notice.

Any references in this information to non-IBM Web sites are provided for convenience only and do not in any manner serve as an endorsement of those Web sites. The materials at those Web sites are not part of the materials for this IBM product and use of those Web sites is at your own risk.

IBM may use or distribute any of the information you supply in any way it believes appropriate without incurring any obligation to you.

Licensees of this program who wish to have information about it for the purpose of enabling: (i) the exchange of information between independently created programs and other programs (including this one) and (ii) the mutual use of the information which has been exchanged, should contact:

IBM Corporation

| Software Interoperability Coordinator, Department YBWA
| 3605 Highway 52 N
| Rochester, MN 55901
| U.S.A.

| Such information may be available, subject to appropriate terms and conditions, including in some cases,
| payment of a fee.

| The licensed program described in this information and all licensed material available for it are provided
| by IBM under terms of the IBM Customer Agreement, IBM International Program License Agreement,
| IBM License Agreement for Machine Code, or any equivalent agreement between us.

| Any performance data contained herein was determined in a controlled environment. Therefore, the
| results obtained in other operating environments may vary significantly. Some measurements may have
| been made on development-level systems and there is no guarantee that these measurements will be the
| same on generally available systems. Furthermore, some measurements may have been estimated through
| extrapolation. Actual results may vary. Users of this document should verify the applicable data for their
| specific environment.

| Information concerning non-IBM products was obtained from the suppliers of those products, their
| published announcements or other publicly available sources. IBM has not tested those products and
| cannot confirm the accuracy of performance, compatibility or any other claims related to non-IBM
| products. Questions on the capabilities of non-IBM products should be addressed to the suppliers of
| those products.

| All statements regarding IBM's future direction or intent are subject to change or withdrawal without
| notice, and represent goals and objectives only.

| This information is for planning purposes only. The information herein is subject to change before the
| products described become available.

| This information contains examples of data and reports used in daily business operations. To illustrate
| them as completely as possible, the examples include the names of individuals, companies, brands, and
| products. All of these names are fictitious and any similarity to the names and addresses used by an
| actual business enterprise is entirely coincidental.

| COPYRIGHT LICENSE:

| This information contains sample application programs in source language, which illustrate programming
| techniques on various operating platforms. You may copy, modify, and distribute these sample programs
| in any form without payment to IBM, for the purposes of developing, using, marketing or distributing
| application programs conforming to the application programming interface for the operating platform for
| which the sample programs are written. These examples have not been thoroughly tested under all
| conditions. IBM, therefore, cannot guarantee or imply reliability, serviceability, or function of these
| programs.

| Each copy or any portion of these sample programs or any derivative work, must include a copyright
| notice as follows:

| © (your company name) (year). Portions of this code are derived from IBM Corp. Sample Programs. ©
| Copyright IBM Corp. _enter the year or years_. All rights reserved.

| If you are viewing this information softcopy, the photographs and color illustrations may not appear.

Programming Interface Information

This APPC, APPN, and HPR publication documents intended Programming Interfaces that allow the customer to write programs to obtain the services of IBM i5/OS.

Trademarks

The following terms are trademarks of International Business Machines Corporation in the United States, other countries, or both:

- 3090
- Advanced Function Printing
- Advanced Peer-to-Peer Networking
- AnyNet
- AS/400
- Extended Services
- i5/OS
- IBM
- iSeries
- Power PC
- System/36
- System/390
- VTAM

Intel, Intel Inside (logos), MMX, and Pentium are trademarks of Intel Corporation in the United States, other countries, or both.

Microsoft, Windows, Windows NT, and the Windows logo are trademarks of Microsoft Corporation in the United States, other countries, or both.

Java and all Java-based trademarks are trademarks of Sun Microsystems, Inc. in the United States, other countries, or both.

Linux is a trademark of Linus Torvalds in the United States, other countries, or both.

UNIX is a registered trademark of The Open Group in the United States and other countries.

Other company, product, or service names may be trademarks or service marks of others.

Terms and conditions

Permissions for the use of these publications is granted subject to the following terms and conditions.

Personal Use: You may reproduce these publications for your personal, noncommercial use provided that all proprietary notices are preserved. You may not distribute, display or make derivative works of these publications, or any portion thereof, without the express consent of IBM.

Commercial Use: You may reproduce, distribute and display these publications solely within your enterprise provided that all proprietary notices are preserved. You may not make derivative works of these publications, or reproduce, distribute or display these publications or any portion thereof outside your enterprise, without the express consent of IBM.

Except as expressly granted in this permission, no other permissions, licenses or rights are granted, either express or implied, to the publications or any information, data, software or other intellectual property contained therein.

| IBM reserves the right to withdraw the permissions granted herein whenever, in its discretion, the use of
| the publications is detrimental to its interest or, as determined by IBM, the above instructions are not
| being properly followed.

| You may not download, export or re-export this information except in full compliance with all applicable
| laws and regulations, including all United States export laws and regulations.

| IBM MAKES NO GUARANTEE ABOUT THE CONTENT OF THESE PUBLICATIONS. THE
| PUBLICATIONS ARE PROVIDED "AS-IS" AND WITHOUT WARRANTY OF ANY KIND, EITHER
| EXPRESSED OR IMPLIED, INCLUDING BUT NOT LIMITED TO IMPLIED WARRANTIES OF
| MERCHANTABILITY, NON-INFRINGEMENT, AND FITNESS FOR A PARTICULAR PURPOSE.



Printed in USA