



System i

Hardware installation and use

Cabling instructions for eServer iSeries models 270 and
8xx

Version 5 Release 4





System i

Hardware installation and use

Cabling instructions for eServer iSeries models 270 and
8xx

Version 5 Release 4

Note

Before using this information and the product it supports, read the information in "Notices," on page 117.

Fifth Edition (February 2006)

This edition applies to version 5, release 4, modification 0 of IBM i5/OS (product number 5722-SS1) and to all subsequent releases and modifications until otherwise indicated in new editions. This version does not run on all reduced instruction set computer (RISC) models nor does it run on CISC models.

© Copyright International Business Machines Corporation 2002, 2006. All rights reserved.

US Government Users Restricted Rights – Use, duplication or disclosure restricted by GSA ADP Schedule Contract with IBM Corp.

Contents

Cabling your server.	1
Printable PDF	1
Selecting the model 270 cabling instructions	1
Cabling a model 270 and twinaxial console with an expansion unit.	1
Connecting the twinaxial cable	3
Connecting the electronic customer support cable	4
Cabling the expansion unit	4
Connecting the power cords	4
Connecting external cables.	5
Turning on your server	8
Setting up your server	8
Cabling a model 270 and twinaxial console without an expansion unit.	8
Connecting the twinaxial cable	10
Connecting the electronic customer support cable.	11
Connecting the power cords	11
Connecting external cables	11
Turning on your server	14
Setting up your server.	15
Cabling a model 270 and Operations Console with an expansion unit	15
Connecting the Operations Console cable	16
Connecting the electronic customer support cable	17
Cabling the expansion unit	17
Connecting the power cords.	17
Connecting external cables	18
Turning on your server	21
Setting up your server.	21
Cabling a model 270 and Operations Console without an expansion unit	21
Connecting the Operations Console cable	23
Connecting the electronic customer support cable	23
Connecting the power cords.	24
Connecting external cables	24
Turning on your server	27
Setting up your server.	28
Selecting the cabling instructions for a model 800 or model 810	28
Cabling a model 800 or model 810 and twinaxial console with an expansion unit.	28
Connecting the twinaxial cable	29
Connecting the electronic customer support cable	30
Cabling the expansion unit	30
Connecting the power cords.	30
Connecting external cables	31
Turning on your server	34
Setting up your server.	34
Cabling a model 800 or model 810 and twinaxial console without an expansion unit.	35
Connecting the twinaxial cable	36
Connecting the electronic customer support cable	37
Connecting the power cords.	37
Connecting external cables	37
Turning on your server	40
Setting up your server.	41
Cabling a model 800 or model 810 with an expansion unit and Operations Console	41
Connecting the Operations Console cable	43
Connecting the electronic customer support cable	43
Cabling the expansion unit	44
Connecting the power cords.	44
Connecting external cables	44
Turning on your server	47
Setting up your server.	48
Cabling a model 800 or model 810 and Operations Console without an expansion unit	48
Connecting the Operations Console cable	49
Connecting the electronic customer support cable	50
Connecting the power cords.	50
Connecting external cables	50
Turning on your server	54
Setting up your server.	54
Selecting the model 820 cabling instructions	54
Cabling a model 820 and twinaxial console with an expansion unit	54
Connecting the twinaxial cable	56
Connecting the electronic customer support cable	56
Cabling the expansion unit	57
Connecting the power cords.	57
Connecting external cables	57
Turning on your server	60
Setting up your server.	61
Cabling a model 820 and twinaxial console without an expansion unit	61
Connecting the twinaxial cable	63
Connecting the electronic customer support cable	63
Connecting the power cords.	64
Connecting external cables	64
Turning on your server	67
Setting up your server.	68
Cabling a model 820 and Operations Console with an expansion unit	68
Connecting the Operations Console cable	69
Connecting the electronic customer support cable	70
Cabling the expansion unit	70
Connecting the power cords.	70
Connecting external cables	71
Turning on your server	74
Setting up your server.	74

Cabling a model 820 and Operations Console without an expansion unit	74	Connecting the Operations Console cable	95
Connecting the Operations Console cable	76	Connecting the electronic customer support cable	96
Connecting the electronic customer support cable	76	Cabling the expansion unit	96
Connecting the power cords	77	Connecting the power cords	96
Connecting external cables	77	Connecting external cables	97
Turning on your server	80	Turning on your server	100
Setting up your server	81	Setting up your server	100
Selecting the model 825 cabling instructions	81	Cabling a model 825 and Operations Console without an expansion unit	100
Cabling a model 825 and twinaxial console with an expansion unit	81	Connecting the Operations Console cable	102
Connecting the twinaxial cable	82	Connecting the electronic customer support cable	102
Connecting the electronic customer support cable	83	Connecting the power cords	103
Cabling the expansion unit	83	Connecting external cables	103
Connecting the power cords	83	Turning on your server	106
Connecting external cables	84	Setting up your server	107
Turning on your server	87	Cabling a model 890 or model 870 Operations Console	108
Setting up your server	87	Setting up a rack	108
Cabling a model 825 and twinaxial console without an expansion unit	88	Installing the front tip plate	109
Connecting the twinaxial cable	89	Removing the shipping brackets	109
Connecting the electronic customer support cable	90	Cabling your rack	113
Connecting the power cords	90		
Connecting external cables	90	Appendix. Notices	117
Turning on your server	93	Trademarks	119
Setting up your server	94	Terms and conditions	119
Cabling a model 825 and Operations Console with an expansion unit	94		

Cabling your server

This topic collection provides information about how to properly cable your server.

Printable PDF

Use this to view and print a PDF of this information.

To view or download the PDF version of this document, select Cabling your server (about 2906 KB).

Saving PDF files

To save a PDF on your workstation for viewing or printing:

1. Right-click the PDF in your browser (right-click the link above).
2. Click the option that saves the PDF locally.
3. Navigate to the directory in which you want to save the PDF.
4. Click **Save**.

Downloading Adobe Reader

You need Adobe Reader installed on your system to view or print these PDFs. You can download a free copy from the Adobe Web site (www.adobe.com/products/acrobat/readstep.html) .

Selecting the model 270 cabling instructions

Before you connect cables to your server, select the cabling instructions that best match the server you are setting up.

Related tasks

“Cabling your rack” on page 113

To use the cable management arm and fasteners provided with the rack, follow these steps. The rack has a cable management arm and fasteners that help manage excess cabling and secure your cables within the rack. The steps in this topic describe how to use the cable management arm and fasteners provided with the rack.

Cabling a model 270 and twinaxial console with an expansion unit

To connect the cables to your server and the console, follow these instructions.

Print this topic using the Print key.

Note: If you are installing your server in a rack, see Installing System i™ features.

Attach the 8-port Twinaxial cable to the 2746 connector in position C05 or C06.

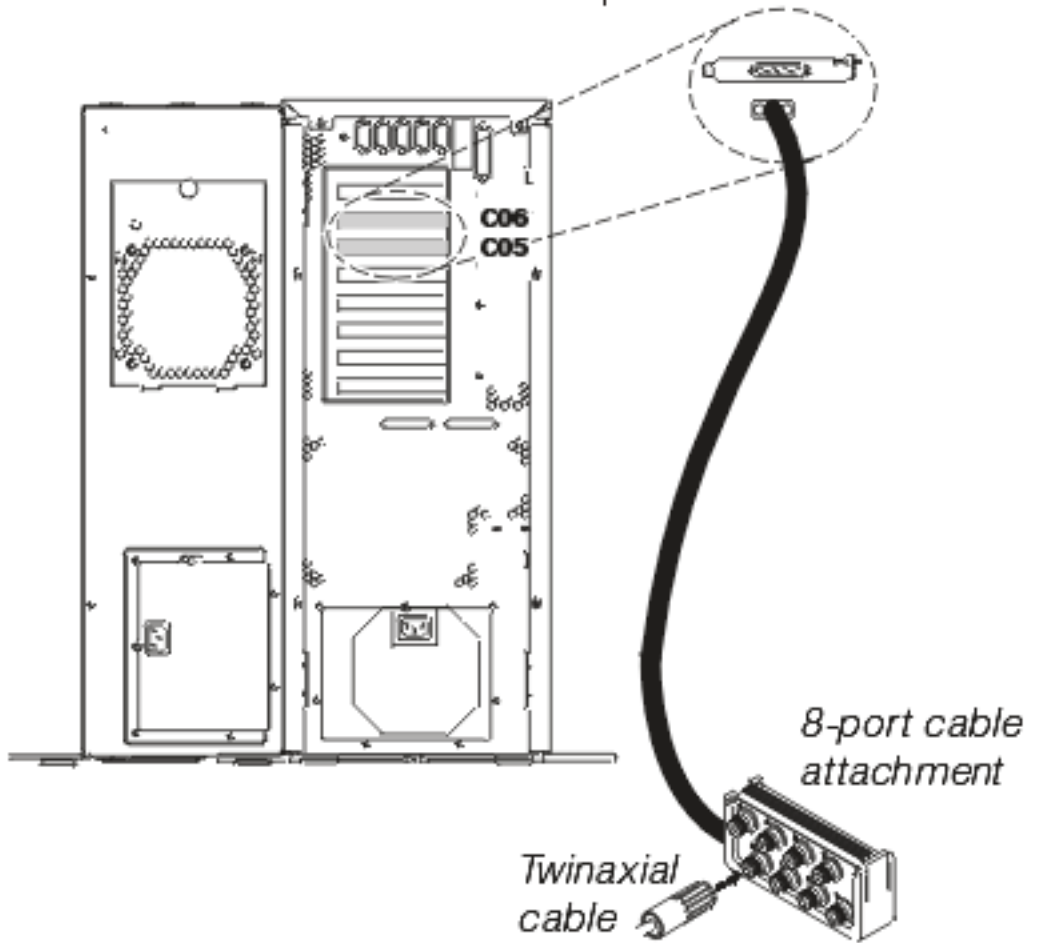

RZAM8610-1

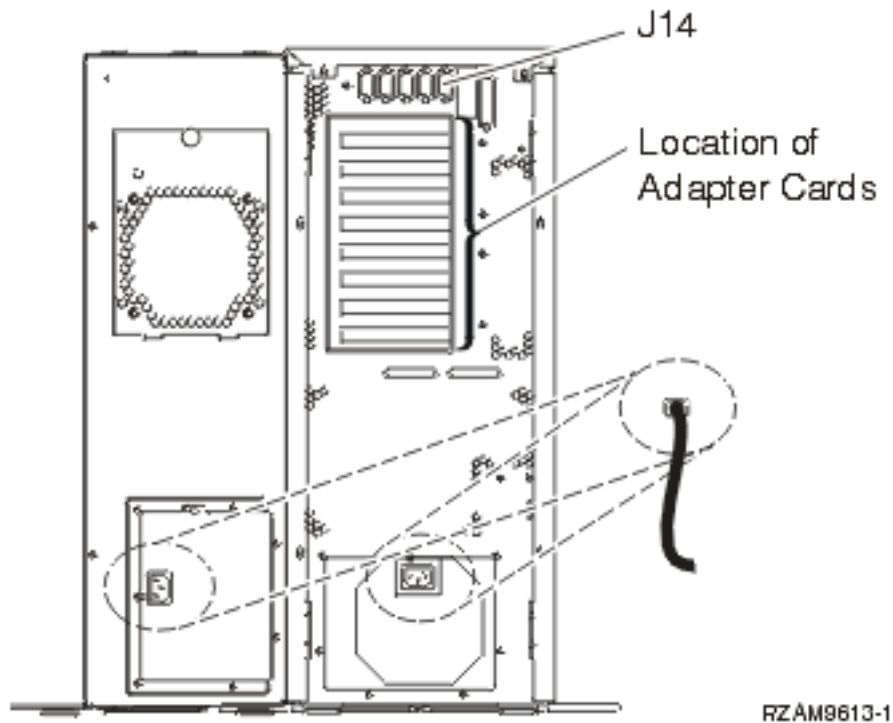
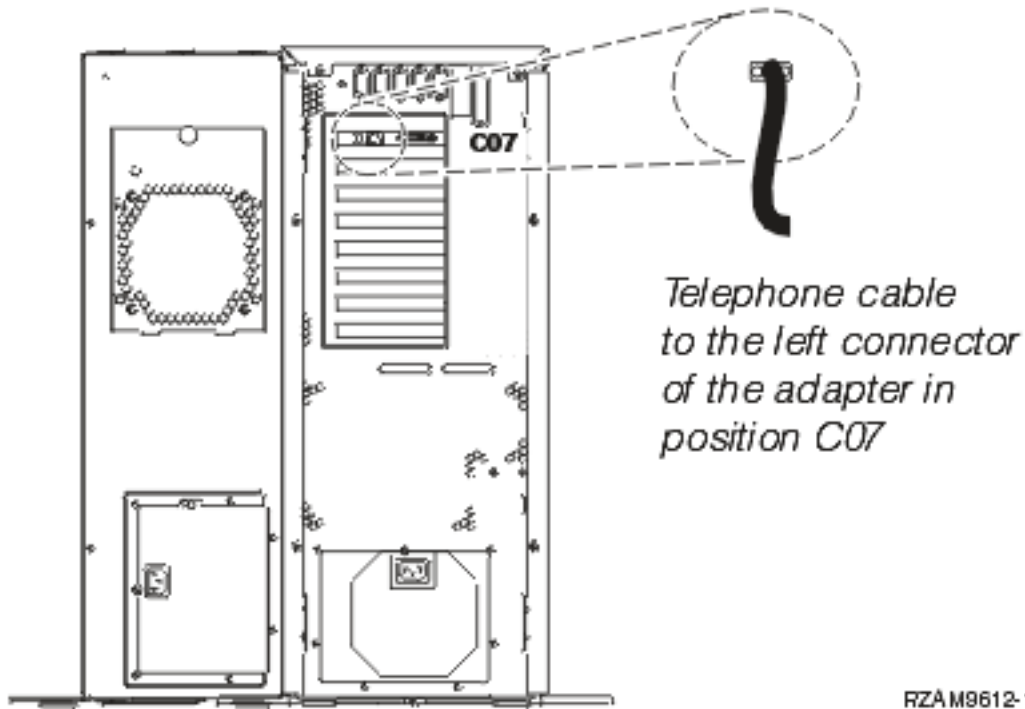

Connecting the twinaxial cable

To connect the twinaxial cable, complete these steps.

1. If installed, lift the back cover and remove it from the server.

2. Look at card positions C05 and C06 on the back of the server. Locate the position that contains card 2746. This is your twinaxial adapter. If both positions contain card 2746, then select the card in position C06.
3. Locate the 8-port twinaxial attachment cable (PN 21F5093). Attach the cable to the connector on the 2746 twinaxial adapter.
4. Connect a twinaxial cable from the workstation that you are using as the system console to port 0 on the 8-port twinaxial attachment cable.

Note: The workstation address of your console must be set to 0. To set the address, refer to the reference material that was included with your workstation.

5. Continue with the next task.

Connecting the electronic customer support cable

To connect the electronic customer support cable, complete these steps.

Are you installing electronic customer support?

- **No:** Continue with the next task.
- **Yes**
 1. Connect a telephone cable to the left connector of the 2771 or 2793 adapter located in position C07.
 2. Connect the other end of the telephone cable to an analog telephone jack.

Electronic customer support helps automate the management of your server and streamline your support. Find out more about electronic customer support by looking at the IBM® System i Technical Support Advantage information included with your server, or go to the Support for IBM

System i  Web site. Electronic customer support can be configured using the *iSeries™ Setup and Operations* CD-ROM that came with your server.

Continue with the next task.

Cabling the expansion unit

To set up your expansion unit, select the appropriate information from this list.

- Setting Up Your 5075 Expansion Unit 
- Setting Up Your 0588, 0595, 5088, 5094, 5095 or 5294 Expansion Unit 

Note: Do not plug the expansion-unit power cord (also known as power cable) into the power outlet as indicated in the *Setting Up Your 5075 Expansion Unit* document. You need to plug the expansion-unit power cable into the power outlet later in this procedure.

After you have set up the expansion unit and replaced the back cover, continue with the next task.

Connecting the power cords

To connect the power cords, follow these instructions.

If you have a 4758 PCI Cryptographic Coprocessor card to install, go to the instructions that came with the card. This card was included in a separate box. Return here after the card is installed.

Are you installing an uninterruptible power supply?

- **No:** Connect the server power cords to the server.

Note: Do not plug the power cord into the power outlet. Do not turn on your server.

Continue with the next task.

- **Yes:** Connect the power control cable for the uninterruptible power supply to J14. Do not plug the power cord of the uninterruptible power supply into the outlet and do not turn on your server. For

instructions to complete the installation of the uninterruptible power supply, go to the Web site Powerware UPS Solutions for IBM (<http://www.oem.powerware.com/ibm-ups/Products/>

9910Solutions/ina.asp)  .

Continue with the next task.

Connecting external cables

To connect external cables, follow these instructions.

If you do not have any external cables to connect to the adapter cards on the back of your server or expansion unit, continue with the next task.

1. Use this table to connect the cables to the matching adapters on the back of your server. You might need to connect more than one cable.

Note: If the cable did not come with your server, then you need to supply it.

Table 1. Cables and adapters







Cables and connectors	Adapter type numbers	Adapters (located on the back of the server)
PCI two-line WAN		
44H7xxx or 97H73xx 	4745/2745/2742	PCI Two-line WAN Input/Output Adapter 
44H7xxx, 97H73xx, or 44H748x  Integrated modem 87G62xx, 21H49xx, or 75G38xx 	2793/2794/2771	PCI Two-line WAN with Modem Input/Output Adapter 
PCI dual WAN		
Integrated modem 87G62xx, 21H49xx, or 75G38xx 	2772/2773	PCI Dual WAN with Modem Input/Output Adapter 
PCI twinaxial		
Part number 12F5093 	4746/9746/2746	PCI Twinaxial Workstation Controller Input/Output Adapter 
PCI token-ring		

Table 1. Cables and adapters (continued)

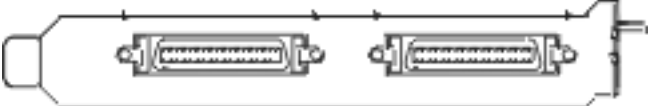

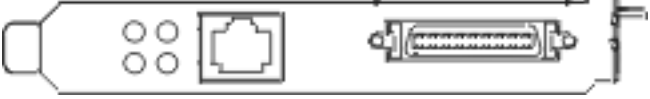

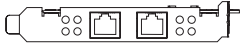

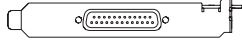

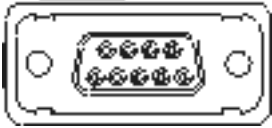

Cables and connectors	Adapter type numbers	Adapters (located on the back of the server)
RJ45 Token-ring  Filter P75G5958 or 75G2865  6339098 	2744/4959	PCI 4/16/100 Mbps Token-Ring Input/Output Adapter 
PCI quad		
	2805/2806	PCI Quad Modem Input/Output Adapter 
	6312	PCI Quad Digital Trunk Adapter 
Ethernet		
RJ45 Ethernet 	2838/2849	PCI 100/10 Mbps Ethernet Input/Output Adapter 
	5700	PCI 1 Gbps Ethernet Input/Output Adapter 
	5701	PCI 1 Gbps Ethernet UTP Input/Output Adapter 
	5706	PCI 1 Gbps Ethernet TX Input/Output Adapter 
	5707	PCI 1 Gbps Ethernet SX Input/Output Adapter 
	5718	PCI 10 Gbps Ethernet Input/Output Adapter 
Server cards		

Table 1. Cables and adapters (continued)

Cables and connectors	Adapter type numbers	Adapters (located on the back of the server)
<p>Part number 45H2433</p> <p>44H8677 connects to cable 45H2433</p>  <p>Video extension cable, 44H8676</p> 	2891/2892	<p>Netfinity® Server Card</p> 
	4810/9710	<p>Integrated xSeries® server card</p> 
	4821/9712	<p>Integrated xSeries server card</p>
RAID disk unit controllers		
	2757	<p>PCI Ultra RAID Disk Unit Controller</p>
	2780	<p>PCI-X Ultra4 RAID Disk Unit Controller</p>
	5703/4778	<p>PCI-X RAID Disk Unit Controller</p> 
	5709	<p>RAID Enabler Card</p>
Fibre channel disk unit controllers		
	2787	<p>PCI-X Fibre Channel Disk Unit Controller</p>
PCI cryptography		
	4801/4758-023	<p>PCI Cryptographic Coprocessor</p> 
	4805/2058	<p>PCI Cryptographic Accelerator</p>
PCI-X tape unit controllers		
	5704	<p>PCI-X Fibre Channel Tape Unit Controller</p> 
	5702/5712/5715	<p>PCI-X U320 Tape/Disk Unit Controller</p> 
Bus adapters		
	2886	<p>Optical Bus Adapter</p> 

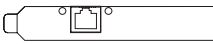
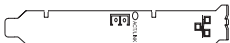
Table 1. Cables and adapters (continued)

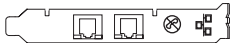
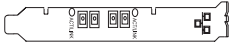
Cables and connectors	Adapter type numbers	Adapters (located on the back of the server)
	2887	HSL-2 Bus Adapter 
	6417/28E7	HSL-2/RIO-G Bus Adapter 

2. Connect the other end of the external cables to a network or device.
3. Continue with the next task.

Turning on your server

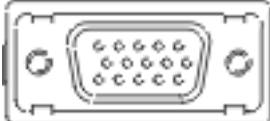
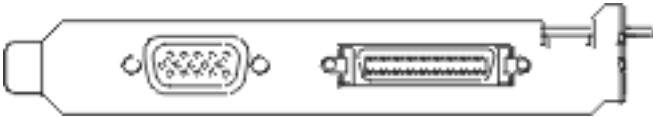
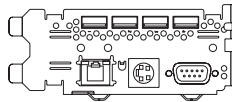
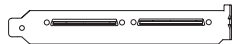
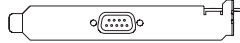
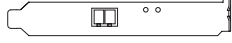
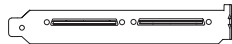
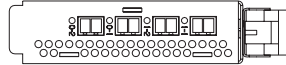
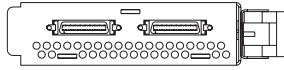
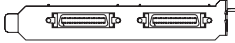
Before you turn on your server, complete these steps.

1. Plug in and turn on your console.
2. Plug in your server or uninterruptible power supply.
3. Plug in any attached expansion units.
4. Open the control panel door on the front of the server. The control panel should be lit and display 01 BN V=F. The server is not yet powered on.

Note: If 01 BN V=F is not on the display, you might need to change the mode. If you need these instructions, go to the Working with the control panel topic in the information center.

5. Press the white Power On button. There is a short delay until the server starts to turn on. It takes 5 to 20 minutes. 01 BN V=F or A900 2000, which indicates the console is not connected yet, appears on the control panel when the server is powered on.
6. Install the back cover on the server.
You have cabled your server.
7. Continue with the next section.

Note: If you plan to install any Linux[®] specific hardware, or if you plan to create logical partitions on your iSeries, you might need to add or move some hardware, such as network I/O adapters, at this time. If you are unsure as to where to put the new or changed hardware, run the LPAR

Validation Tool (LVT) . You can find information about LPAR in the Logical partitions topic and additional information in the Linux in a logical partition topic of the information center.

Setting up your server

To set up your server, follow these instructions.

If you have a PC connected to the LAN, you can use EZ-Setup on the *iSeries Setup and Operations* CD-ROM to complete your server setup.

If you do not have a PC connected to the LAN, go to Setting Up Your Twinaxial System  to continue with your server setup.

Cabling a model 270 and twinaxial console without an expansion unit

To connect the cables to your server and to the console, follow these instructions.

Print this topic using the Print key.

Note: If you are installing your server in a rack, see Installing System i features.

Attach the 8-port Twinaxial cable to the 2746 connector in position C05 or C06.

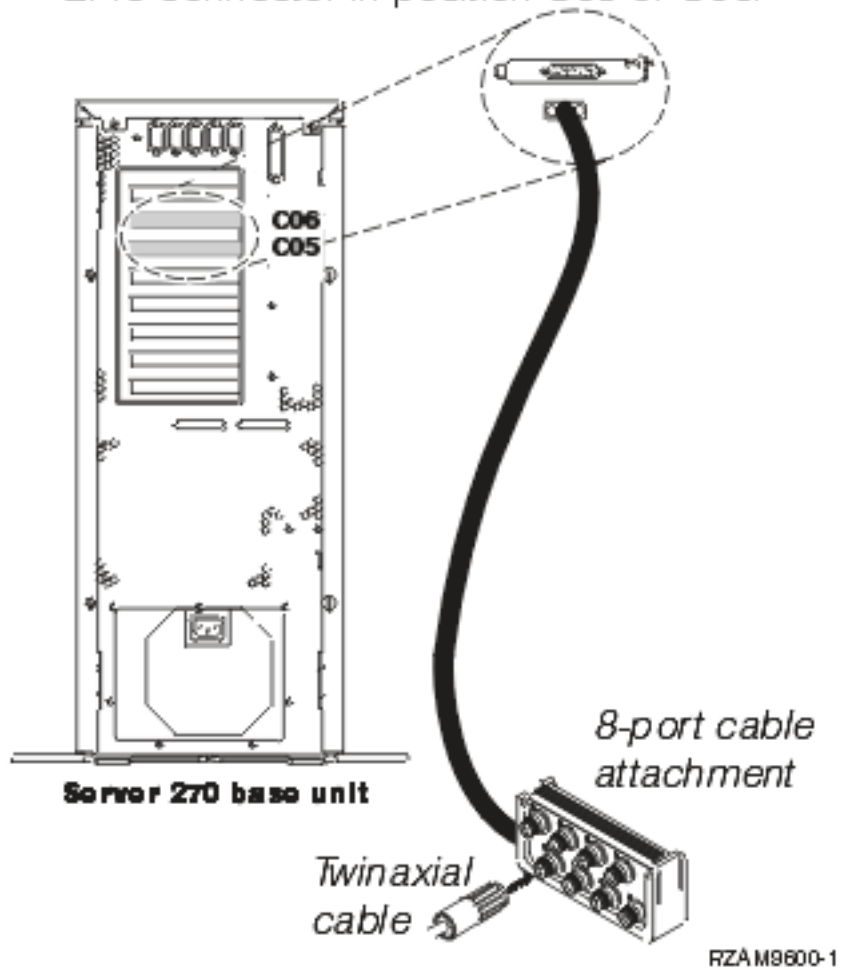

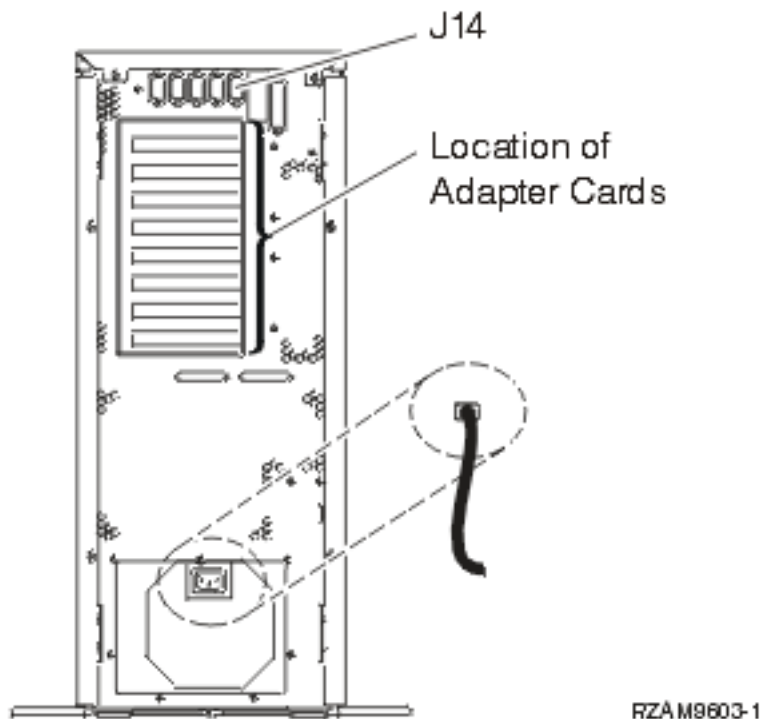
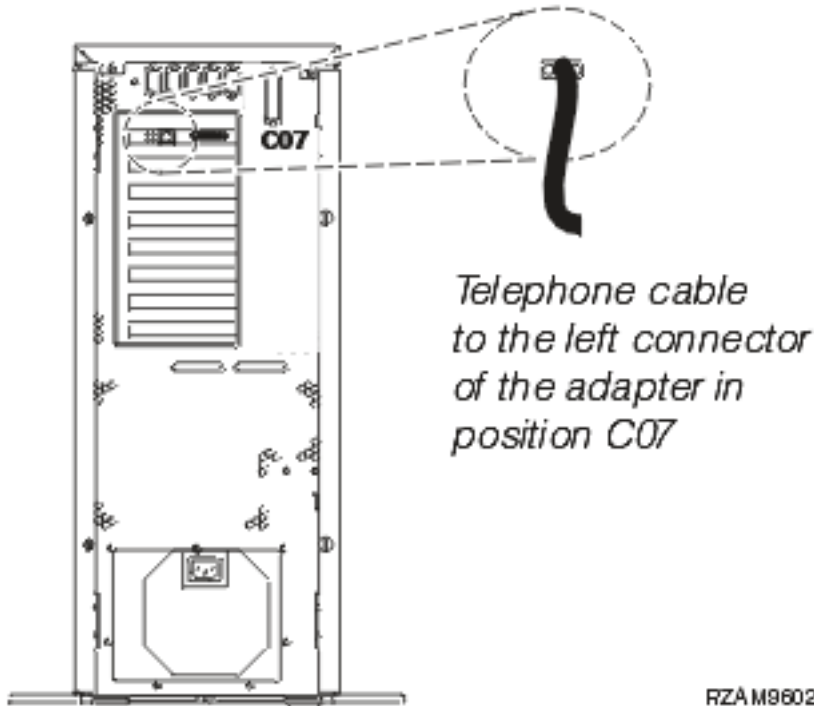

Connecting the twinaxial cable

To connect the twinaxial cable, complete these steps.

1. If installed, lift the back cover and remove it from the server.
2. Look at card positions C05 and C06 on the back of the server. Locate the position that contains card 2746. This is your twinaxial adapter. If both positions contain card 2746, then select the card in position C06.

3. Locate the 8-port twinaxial attachment cable (PN 21F5093). Attach the cable to the connector on the 2746 twinaxial adapter.
4. Connect a twinaxial cable from the workstation that you are using as the system console to port 0 on the 8-port twinaxial attachment cable.

Note: The workstation address of your console must be set to 0. To set the address, refer to the reference material that was included with your workstation.

5. Continue with the next task.

Connecting the electronic customer support cable

To connect the electronic customer support cable, complete these steps.

Are you installing electronic customer support?

- **No:** Continue with the next task.

- **Yes**

1. Connect a telephone cable to the left connector of the 2771 or 2793 adapter located in position C07.
2. Connect the other end of the telephone cable to an analog telephone jack.

Electronic customer support helps automate the management of your server and streamline your support. Find out more about electronic customer support by looking at the IBM System i Technical Support Advantage information included with your server, or go to the Support for IBM System i

 Web site. Electronic customer support can be configured using the *iSeries Setup and Operations* CD-ROM that came with your server.

Continue with the next task.

Connecting the power cords

To connect the power cords, follow these instructions.

If you have a 4758 PCI Cryptographic Coprocessor card to install, go to the instructions that came with the card. This card was included in a separate box. Return here after the card is installed.

Are you installing an uninterruptible power supply?

- **No:** Connect the server power cords to the server.

Note: Do not plug the power cord into the power outlet. Do not turn on your server.

Continue with the next task.

- **Yes:** Connect the power control cable for the uninterruptible power supply to J14. Do not plug the power cord of the uninterruptible power supply into the outlet and do not turn on your server. For instructions to complete the installation of the uninterruptible power supply, go to the Web site Powerware UPS Solutions for IBM (<http://www.oem.powerware.com/ibm-ups/Products/>

9910Solutions/ina.asp) .

Continue with the next task.

Connecting external cables

To connect external cables, follow these instructions.

If you do not have any external cables to connect to the adapter cards on the back of your server or expansion unit, continue with the next task.

1. Use this table to connect the cables to the matching adapters on the back of your server. You might need to connect more than one cable.

Note: If the cable did not come with your server, then you need to supply it.

Table 2. Cables and adapters







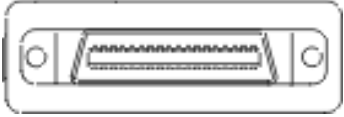
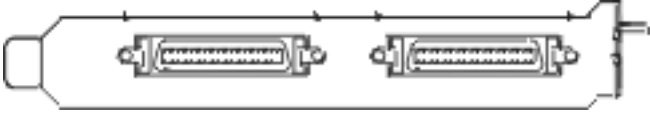
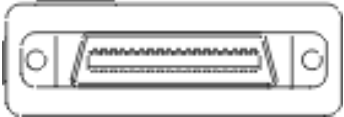

Cables and connectors	Adapter type numbers	Adapters (located on the back of the server)
PCI two-line WAN		
44H7xxx or 97H73xx 	4745/2745/2742	PCI Two-line WAN Input/Output Adapter 
44H7xxx, 97H73xx, or 44H748x  Integrated modem 87G62xx, 21H49xx, or 75G38xx 	2793/2794/2771	PCI Two-line WAN with Modem Input/Output Adapter 
PCI dual WAN		
Integrated modem 87G62xx, 21H49xx, or 75G38xx 	2772/2773	PCI Dual WAN with Modem Input/Output Adapter 
PCI twinaxial		
Part number 12F5093 	4746/9746/2746	PCI Twinaxial Workstation Controller Input/Output Adapter 
PCI token-ring		
RJ45 Token-ring  Filter P75G5958 or 75G2865  6339098 	2744/4959	PCI 4/16/100 Mbps Token-Ring Input/Output Adapter 
PCI quad		

Table 2. Cables and adapters (continued)



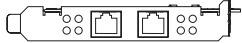
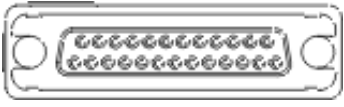
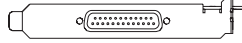



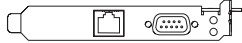

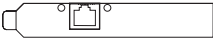

Cables and connectors	Adapter type numbers	Adapters (located on the back of the server)
	2805/2806	PCI Quad Modem Input/Output Adapter 
	6312	PCI Quad Digital Trunk Adapter 
Ethernet		
RJ45 Ethernet 	2838/2849	PCI 100/10 Mbps Ethernet Input/Output Adapter 
	5700	PCI 1 Gbps Ethernet Input/Output Adapter 
	5701	PCI 1 Gbps Ethernet UTP Input/Output Adapter 
	5706	PCI 1 Gbps Ethernet TX Input/Output Adapter 
	5707	PCI 1 Gbps Ethernet SX Input/Output Adapter 
	5718	PCI 10 Gbps Ethernet Input/Output Adapter 
Server cards		
Part number 45H2433 44H8677 connects to cable 45H2433  Video extension cable, 44H8676 	2891/2892	Netfinity Server Card 
	4810/9710	Integrated xSeries server card 
	4821/9712	Integrated xSeries server card
RAID disk unit controllers		
	2757	PCI Ultra RAID Disk Unit Controller

Table 2. Cables and adapters (continued)

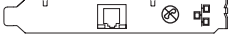
Cables and connectors	Adapter type numbers	Adapters (located on the back of the server)
	2780	PCI-X Ultra4 RAID Disk Unit Controller
	5703/4778	PCI-X RAID Disk Unit Controller 
	5709	RAID Enabler Card
Fibre channel disk unit controllers		
	2787	PCI-X Fibre Channel Disk Unit Controller
PCI cryptography		
	4801/4758-023	PCI Cryptographic Coprocessor 
	4805/2058	PCI Cryptographic Accelerator
PCI-X tape unit controllers		
	5704	PCI-X Fibre Channel Tape Unit Controller 
	5702/5712/5715	PCI-X U320 Tape/Disk Unit Controller 
Bus adapters		
	2886	Optical Bus Adapter 
	2887	HSL-2 Bus Adapter 
	6417/28E7	HSL-2/RIO-G Bus Adapter 

2. Connect the other end of the external cables to a network or device.
3. Continue with the next task.

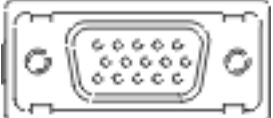
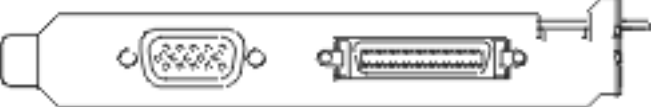
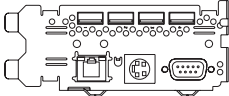
Turning on your server

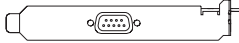
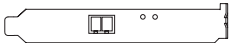
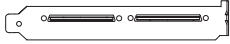
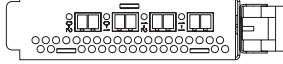
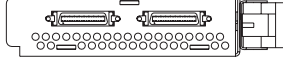
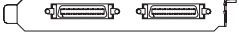
Before you turn on your server, complete these steps.

1. Plug in and turn on your console.
2. Plug in your server or uninterruptible power supply.
3. Plug in any attached expansion units.
4. Open the control panel door on the front of the server. The control panel should be lit and display 01 BN V=F. The server is not yet powered on.

Note: If 01 BN V=F is not on the display, you might need to change the mode. If you need these instructions, go to the Working with the control panel topic in the information center.

5. Press the white Power On button. There is a short delay until the server starts to turn on. It takes 5 to 20 minutes. 01 BN V=F or A900 2000, which indicates the console is not connected yet, appears on the control panel when the server is powered on.

6. Install the back cover on the server.
You have cabled your server.
7. Continue with the next section.

Note: If you plan to install any Linux specific hardware, or if you plan to create logical partitions on your iSeries, you might need to add or move some hardware, such as network I/O adapters, at this time. If you are unsure as to where to put the new or changed hardware, run the LPAR

Validation Tool (LVT) . You can find information about LPAR in the Logical partitions topic and additional information in the Linux in a logical partition topic of the information center.

Setting up your server

To set up your server, follow these instructions.

If you have a PC connected to the LAN, you can use EZ-Setup on the *iSeries Setup and Operations* CD-ROM to complete your server setup.

If you do not have a PC connected to the LAN, go to Setting Up Your Twinaxial System  to continue with your server setup.

Cabling a model 270 and Operations Console with an expansion unit

To connect the cables to your server and to the console, follow these instructions.

Print this topic using the Print key.

Note: If you are installing your server in a rack, see Installing System i features.

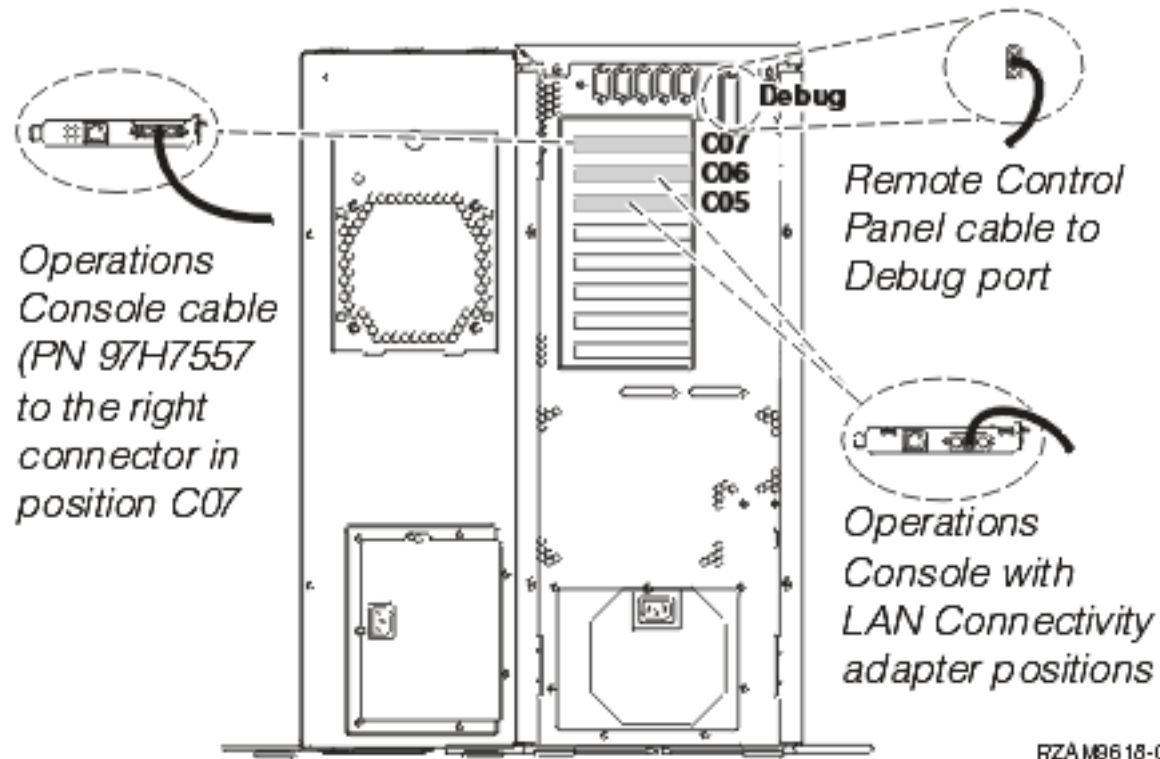

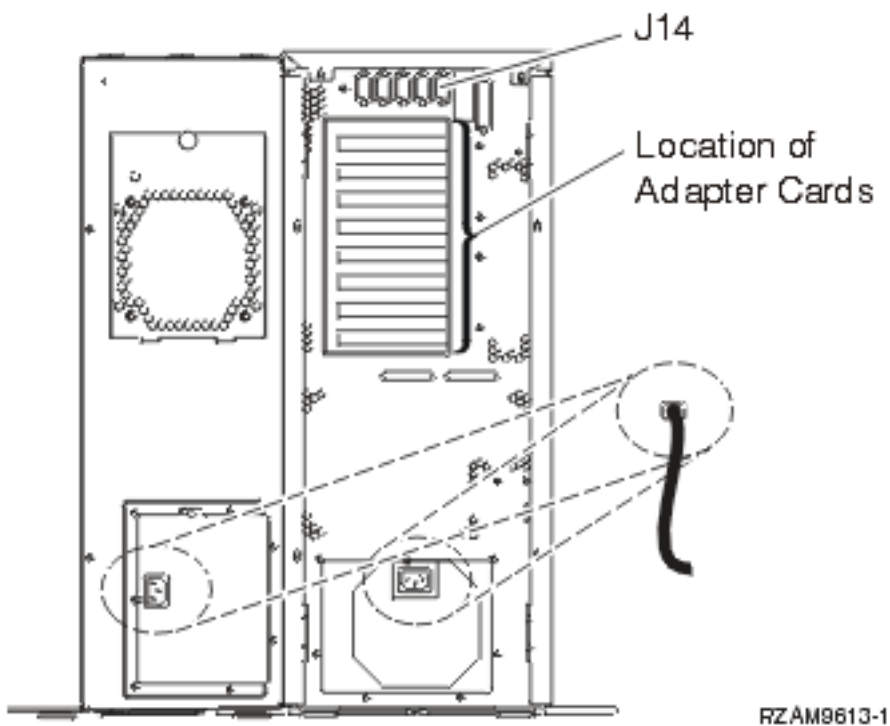
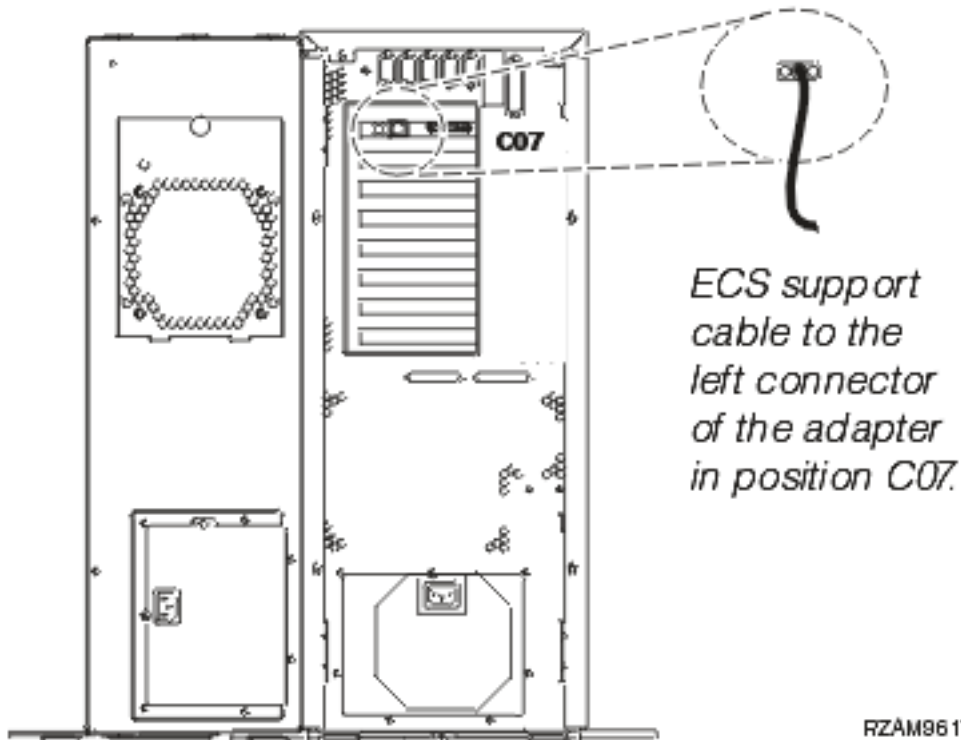

Connecting the Operations Console cable

To connect the Operations Console cable, follow these instructions.

1. Turn off and unplug the PC that is going to serve as the system console.
2. Locate the Operations Console cable (PN 97H7557). Connect the Operations Console cable to the right connector of the 2793 or 2794 adapter located in position C07 on the back of the server.

Are you using Operations Console with LAN connectivity?

- **No**

- a. Connect the other end of the Operations Console cable to the first or only communications (serial) port on the back of the PC being used as the console.
- b. Continue with the next task.

- **Yes**

If your primary choice is LAN connectivity, you do not need to connect the Operations Console cables to your PC at this time. If you develop a problem, you can connect these cables to the PC and set up Operations Console. See Operations Console.

- a. Connect a network cable from the PC that is going to serve as the system console to your local network. Connect a network cable from your local network to the adapter in position C06 or C05.
- b. Continue with the next task.

Related information

Operations Console

Connecting the electronic customer support cable

To connect the electronic customer support cable, complete these steps.

Are you installing electronic customer support?

- **No:** Continue with the next task.

- **Yes**

1. Connect a telephone cable to the left connector of the 2771 or 2793 adapter located in position C07.
2. Connect the other end of the telephone cable to an analog telephone jack.

Electronic customer support helps automate the management of your server and streamline your support. Find out more about electronic customer support by looking at the IBM System i Technical Support Advantage information included with your server, or go to the Support for IBM System i



Web site. Electronic customer support can be configured using the *iSeries Setup and Operations* CD-ROM that came with your server.

Continue with the next task.

Cabling the expansion unit

To set up your expansion unit, select the appropriate information from this list.

- Setting Up Your 5075 Expansion Unit 
- Setting Up Your 0588, 0595, 5088, 5094, 5095 or 5294 Expansion Unit 

Note: Do not plug the expansion-unit power cord (also known as power cable) into the power outlet as indicated in the *Setting Up Your 5075 Expansion Unit* document. You need to plug the expansion-unit power cable into the power outlet later in this procedure.

After you have set up the expansion unit and replaced the back cover, continue with the next task.

Connecting the power cords

To connect the power cords, follow these instructions.

If you have a 4758 PCI Cryptographic Coprocessor card to install, go to the instructions that came with the card. This card was included in a separate box. Return here after the card is installed.

Are you installing an uninterruptible power supply?

- **No:** Connect the server power cords to the server.

Note: Do not plug the power cord into the power outlet. Do not turn on your server.
Continue with the next task.

- **Yes:** Connect the power control cable for the uninterruptible power supply to J14. Do not plug the power cord of the uninterruptible power supply into the outlet and do not turn on your server. For instructions to complete the installation of the uninterruptible power supply, go to the Web site Powerware UPS Solutions for IBM (<http://www.oem.powerware.com/ibm-ups/Products/9910Solutions/ina.asp>)  .
Continue with the next task.

Connecting external cables

To connect external cables, follow these instructions.

If you do not have any external cables to connect to the adapter cards on the back of your server or expansion unit, continue with the next task.

1. Use this table to connect the cables to the matching adapters on the back of your server. You might need to connect more than one cable.

Note: If the cable did not come with your server, then you need to supply it.

Table 3. Cables and adapters





Cables and connectors	Adapter type numbers	Adapters (located on the back of the server)
PCI two-line WAN		
44H7xxx or 97H73xx 	4745/2745/2742	PCI Two-line WAN Input/Output Adapter 
44H7xxx, 97H73xx, or 44H748x  Integrated modem 87G62xx, 21H49xx, or 75G38xx 	2793/2794/2771	PCI Two-line WAN with Modem Input/Output Adapter 
PCI dual WAN		
Integrated modem 87G62xx, 21H49xx, or 75G38xx 	2772/2773	PCI Dual WAN with Modem Input/Output Adapter 
PCI twinaxial		
Part number 12F5093 	4746/9746/2746	PCI Twinaxial Workstation Controller Input/Output Adapter 

Table 3. Cables and adapters (continued)



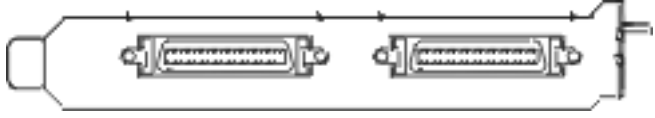
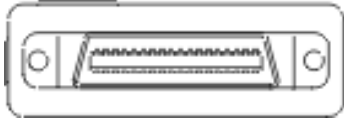

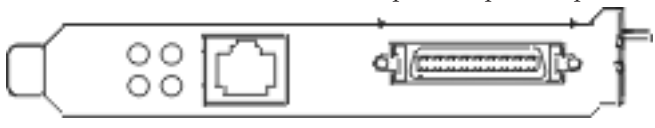

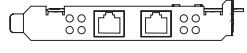
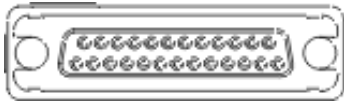
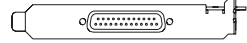

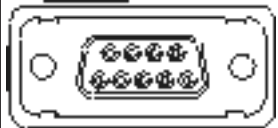

Cables and connectors	Adapter type numbers	Adapters (located on the back of the server)
PCI token-ring		
RJ45 Token-ring  Filter P75G5958 or 75G2865  6339098 	2744/4959	PCI 4/16/100 Mbps Token-Ring Input/Output Adapter 
PCI quad		
	2805/2806	PCI Quad Modem Input/Output Adapter 
	6312	PCI Quad Digital Trunk Adapter 
Ethernet		
RJ45 Ethernet 	2838/2849	PCI 100/10 Mbps Ethernet Input/Output Adapter 
	5700	PCI 1 Gbps Ethernet Input/Output Adapter 
	5701	PCI 1 Gbps Ethernet UTP Input/Output Adapter 
	5706	PCI 1 Gbps Ethernet TX Input/Output Adapter 
	5707	PCI 1 Gbps Ethernet SX Input/Output Adapter 
	5718	PCI 10 Gbps Ethernet Input/Output Adapter 
Server cards		

Table 3. Cables and adapters (continued)

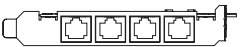
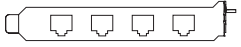

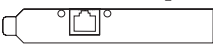

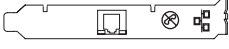
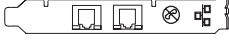
Cables and connectors	Adapter type numbers	Adapters (located on the back of the server)
<p>Part number 45H2433</p> <p>44H8677 connects to cable 45H2433</p>  <p>Video extension cable, 44H8676</p> 	2891/2892	<p>Netfinity Server Card</p> 
	4810/9710	<p>Integrated xSeries server card</p> 
	4821/9712	<p>Integrated xSeries server card</p>
RAID disk unit controllers		
	2757	<p>PCI Ultra RAID Disk Unit Controller</p>
	2780	<p>PCI-X Ultra4 RAID Disk Unit Controller</p>
	5703/4778	<p>PCI-X RAID Disk Unit Controller</p> 
	5709	<p>RAID Enabler Card</p>
Fibre channel disk unit controllers		
	2787	<p>PCI-X Fibre Channel Disk Unit Controller</p>
PCI cryptography		
	4801/4758-023	<p>PCI Cryptographic Coprocessor</p> 
	4805/2058	<p>PCI Cryptographic Accelerator</p>
PCI-X tape unit controllers		
	5704	<p>PCI-X Fibre Channel Tape Unit Controller</p> 
	5702/5712/5715	<p>PCI-X U320 Tape/Disk Unit Controller</p> 
Bus adapters		
	2886	<p>Optical Bus Adapter</p> 

Table 3. Cables and adapters (continued)

Cables and connectors	Adapter type numbers	Adapters (located on the back of the server)
	2887	HSL-2 Bus Adapter 
	6417/28E7	HSL-2/RIO-G Bus Adapter 

2. Connect the other end of the external cables to a network or device.
3. Continue with the next task.

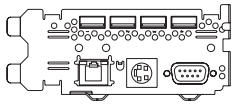
Turning on your server

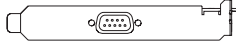
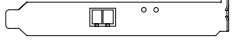
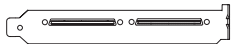
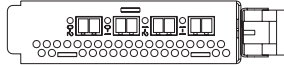
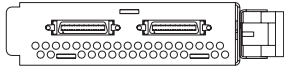
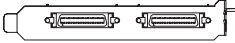
Before you turn on your server, complete these steps.

1. Plug in and turn on your console.
2. Plug in your server or uninterruptible power supply.
3. Plug in any attached expansion units.
4. Open the control panel door on the front of the server. The control panel should be lit and display 01 BN V=F. The server is not yet powered on.

Note: If 01 BN V=F is not on the display, you might need to change the mode. If you need these instructions, go to the Working with the control panel topic in the information center.

5. Press the white Power On button. There is a short delay until the server starts to turn on. It takes 5 to 20 minutes. 01 BN V=F or A900 2000, which indicates the console is not connected yet, appears on the control panel when the server is powered on.
6. Install the back cover on the server.
You have cabled your server.
7. Continue with the next section.

Note: If you plan to install any Linux specific hardware, or if you plan to create logical partitions on your iSeries, you might need to add or move some hardware, such as network I/O adapters, at this time. If you are unsure as to where to put the new or changed hardware, run the LPAR

Validation Tool (LVT)  . You can find information about LPAR in the Logical partitions topic and additional information in the Linux in a logical partition topic of the information center.

Setting up your server

To continue to set up your server, return to EZ-Setup on the *iSeries Setup and Operations* CD-ROM.

Cabling a model 270 and Operations Console without an expansion unit

To connect the cables to your server and to the console, follow these instructions.

Print this topic using the Print key.

Note: If you are installing your server in a rack, see the Installing System i features topic.

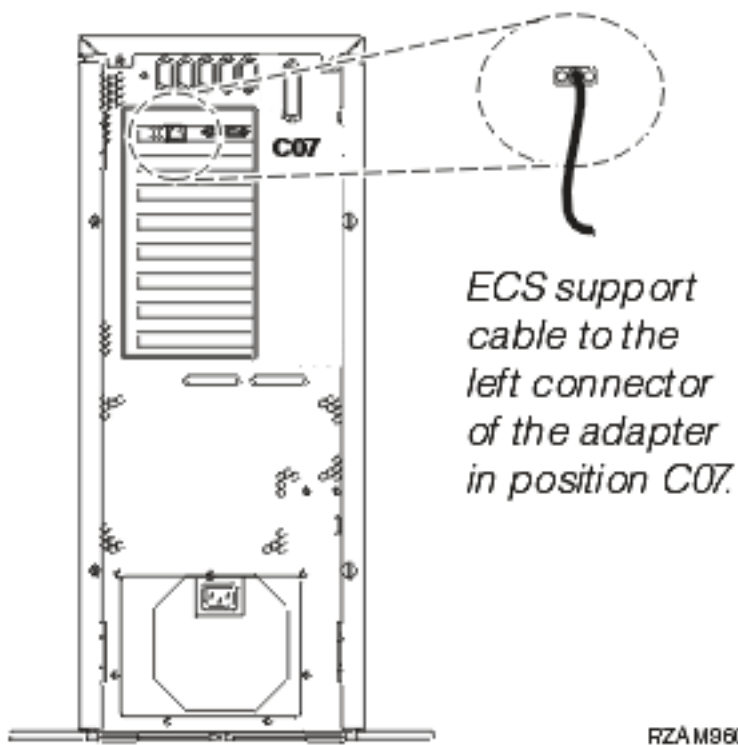
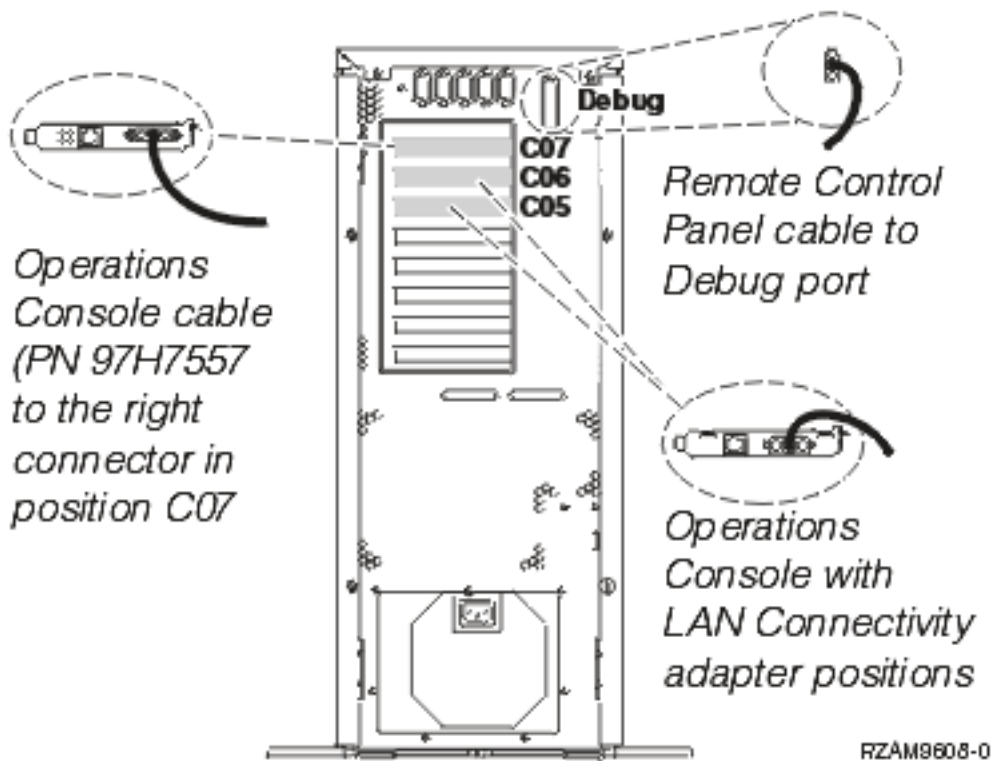

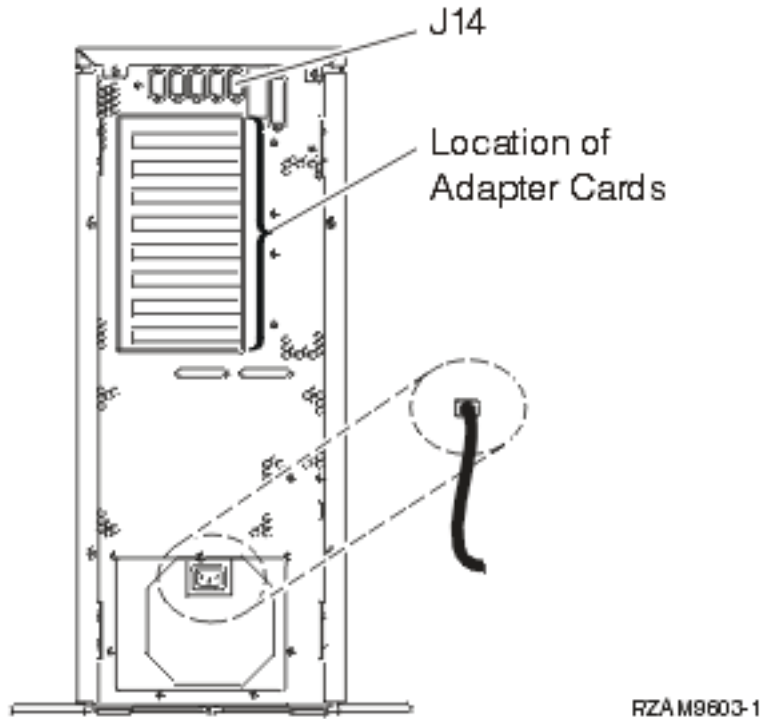

Connecting the Operations Console cable

To connect the Operations Console cable, follow these instructions.

1. Turn off and unplug the PC that is going to serve as the system console.
2. Locate the Operations Console cable (PN 97H7557). Connect the Operations Console cable to the right connector of the 2793 or 2794 adapter located in position C07 on the back of the server.

Are you using Operations Console with LAN connectivity?

- **No**

- a. Connect the other end of the Operations Console cable to the first or only communications (serial) port on the back of the PC being used as the console.
- b. Continue with the next task.

- **Yes**

If your primary choice is LAN connectivity, you do not need to connect the Operations Console cables to your PC at this time. If you develop a problem, you can connect these cables to the PC and set up Operations Console. See Operations Console.

- a. Connect a network cable from the PC that is going to serve as the system console to your local network. Connect a network cable from your local network to the adapter in position C06 or C05.
- b. Continue with the next task.

Connecting the electronic customer support cable

To connect the electronic customer support cable, complete these steps.

Are you installing electronic customer support?

- **No:** Continue with the next task.

- **Yes**

1. Connect a telephone cable to the left connector of the 2771 or 2793 adapter located in position C07.
2. Connect the other end of the telephone cable to an analog telephone jack.

Electronic customer support helps automate the management of your server and streamline your support. Find out more about electronic customer support by looking at the IBM System i Technical

Support Advantage information included with your server, or go to the Support for IBM System i  Web site. Electronic customer support can be configured using the *iSeries Setup and Operations* CD-ROM that came with your server.

Continue with the next task.

Connecting the power cords

To connect the power cords, follow these instructions.

If you have a 4758 PCI Cryptographic Coprocessor card to install, go to the instructions that came with the card. This card was included in a separate box. Return here after the card is installed.

Are you installing an uninterruptible power supply?

- **No:** Connect the server power cords to the server.

Note: Do not plug the power cord into the power outlet. Do not turn on your server.

Continue with the next task.

- **Yes:** Connect the power control cable for the uninterruptible power supply to J14. Do not plug the power cord of the uninterruptible power supply into the outlet and do not turn on your server. For instructions to complete the installation of the uninterruptible power supply, go to the Web site Powerware UPS Solutions for IBM (<http://www.oem.powerware.com/ibm-ups/Products/9910Solutions/ina.asp>) .

Continue with the next task.

Connecting external cables

To connect external cables, follow these instructions.

If you do not have any external cables to connect to the adapter cards on the back of your server or expansion unit, continue with the next task.

1. Use this table to connect the cables to the matching adapters on the back of your server. You might need to connect more than one cable.

Note: If the cable did not come with your server, then you need to supply it.

Table 4. Cables and adapters

Cables and connectors	Adapter type numbers	Adapters (located on the back of the server)
PCI two-line WAN		
44H7xxx or 97H73xx 	4745/2745/2742	PCI Two-line WAN Input/Output Adapter 

Table 4. Cables and adapters (continued)







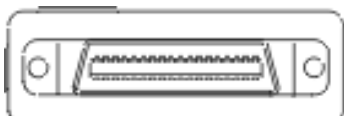
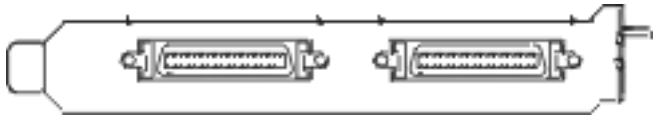

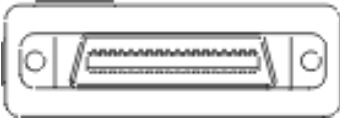

Cables and connectors	Adapter type numbers	Adapters (located on the back of the server)
<p>44H7xxx, 97H73xx, or 44H748x</p>  <p>Integrated modem</p> <p>87G62xx, 21H49xx, or 75G38xx</p> 	<p>2793/2794/2771</p>	<p>PCI Two-line WAN with Modem Input/Output Adapter</p> 
PCI dual WAN		
<p>Integrated modem</p> <p>87G62xx, 21H49xx, or 75G38xx</p> 	<p>2772/2773</p>	<p>PCI Dual WAN with Modem Input/Output Adapter</p> 
PCI twinaxial		
<p>Part number 12F5093</p> 	<p>4746/9746/2746</p>	<p>PCI Twinaxial Workstation Controller Input/Output Adapter</p> 
PCI token-ring		
<p>RJ45 Token-ring</p>  <p>Filter P75G5958 or 75G2865</p>  <p>6339098</p> 	<p>2744/4959</p>	<p>PCI 4/16/100 Mbps Token-Ring Input/Output Adapter</p> 
PCI quad		
	<p>2805/2806</p>	<p>PCI Quad Modem Input/Output Adapter</p> 
	<p>6312</p>	<p>PCI Quad Digital Trunk Adapter</p> 
Ethernet		

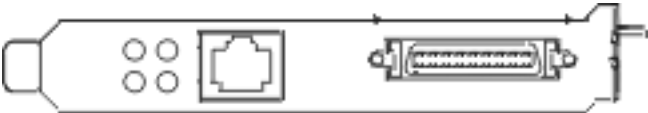
Table 4. Cables and adapters (continued)

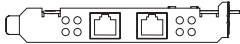
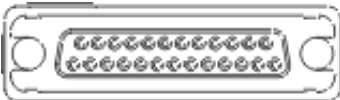
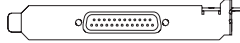







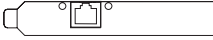
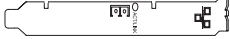

Cables and connectors	Adapter type numbers	Adapters (located on the back of the server)
<p>RJ45 Ethernet</p> 	2838/2849	PCI 100/10 Mbps Ethernet Input/Output Adapter 
	5700	PCI 1 Gbps Ethernet Input/Output Adapter 
	5701	PCI 1 Gbps Ethernet UTP Input/Output Adapter 
	5706	PCI 1 Gbps Ethernet TX Input/Output Adapter 
	5707	PCI 1 Gbps Ethernet SX Input/Output Adapter 
	5718	PCI 10 Gbps Ethernet Input/Output Adapter 
Server cards		
<p>Part number 45H2433</p> <p>44H8677 connects to cable 45H2433</p>  <p>Video extension cable, 44H8676</p> 	2891/2892	Netfinity Server Card 
	4810/9710	Integrated xSeries server card 
	4821/9712	Integrated xSeries server card
RAID disk unit controllers		
	2757	PCI Ultra RAID Disk Unit Controller
	2780	PCI-X Ultra4 RAID Disk Unit Controller
	5703/4778	PCI-X RAID Disk Unit Controller 
	5709	RAID Enabler Card
Fibre channel disk unit controllers		

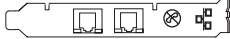
Table 4. Cables and adapters (continued)

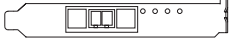
Cables and connectors	Adapter type numbers	Adapters (located on the back of the server)
	2787	PCI-X Fibre Channel Disk Unit Controller 
PCI cryptography		
	4801/4758-023	PCI Cryptographic Coprocessor 
	4805/2058	PCI Cryptographic Accelerator
PCI-X tape unit controllers		
	5704	PCI-X Fibre Channel Tape Unit Controller 
	5702/5712/5715	PCI-X U320 Tape/Disk Unit Controller 
Bus adapters		
	2886	Optical Bus Adapter 
	2887	HSL-2 Bus Adapter 
	6417/28E7	HSL-2/RIO-G Bus Adapter 

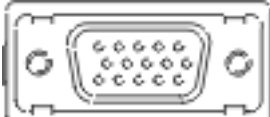
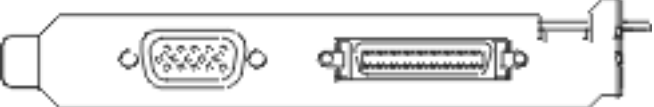
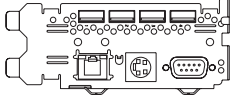
2. Connect the other end of the external cables to a network or device.
3. Continue with the next task.

Turning on your server

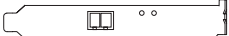
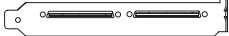
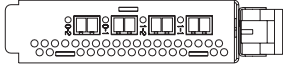
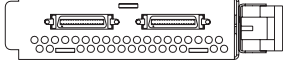
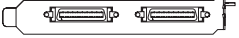
Before you turn on your server, complete these steps.

1. Plug in and turn on your console.
2. Plug in your server or uninterruptible power supply.
3. Plug in any attached expansion units.
4. Open the control panel door on the front of the server. The control panel should be lit and display 01 BN V=F. The server is not yet powered on.

Note: If 01 BN V=F is not on the display, you might need to change the mode. If you need these instructions, go to the Working with the control panel topic in the information center.

5. Press the white Power On button. There is a short delay until the server starts to turn on. It takes 5 to 20 minutes. 01 BN V=F or A900 2000, which indicates the console is not connected yet, appears on the control panel when the server is powered on.
6. Install the back cover on the server.
You have cabled your server.
7. Continue with the next section.

Note: If you plan to install any Linux specific hardware, or if you plan to create logical partitions on your iSeries, you might need to add or move some hardware, such as network I/O adapters, at

this time. If you are unsure as to where to put the new or changed hardware, run the LPAR Validation Tool (LVT) . You can find information about LPAR in the Logical partitions topic and additional information in the Linux in a logical partition topic of the information center.

Setting up your server

To continue to set up your server, return to EZ-Setup on the *iSeries Setup and Operations* CD-ROM.

Selecting the cabling instructions for a model 800 or model 810

Before you cable a server, select the cabling instructions that best match the server you are setting up.

Cabling a model 800 or model 810 and twinaxial console with an expansion unit

To connect the cables to your server and to the console, follow these instructions.

Print this topic using the Print key.

Note: If you are installing your server in a rack, see the Installing System i features topic.

Attach the 8-port Twinaxial cable to the 2746 connector in position C06 through C02.

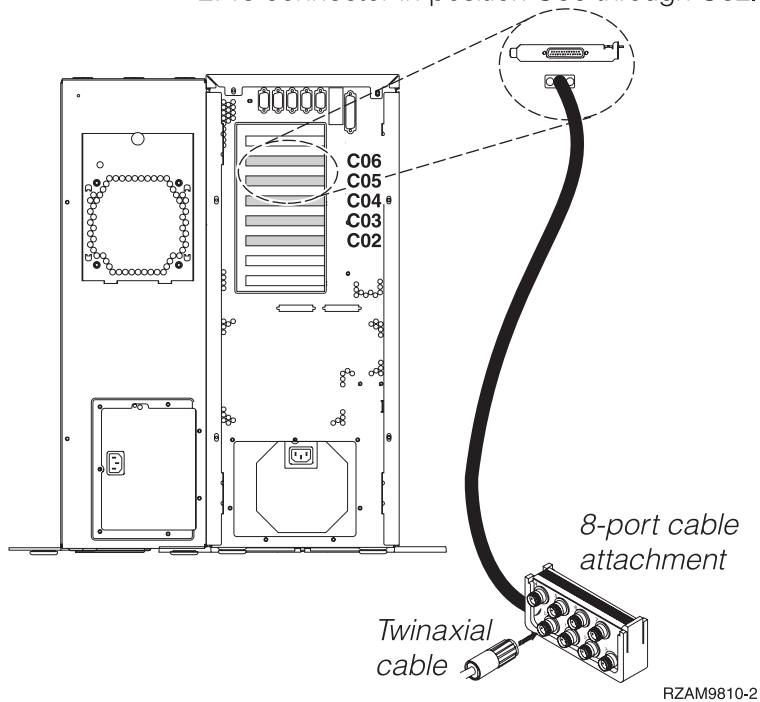

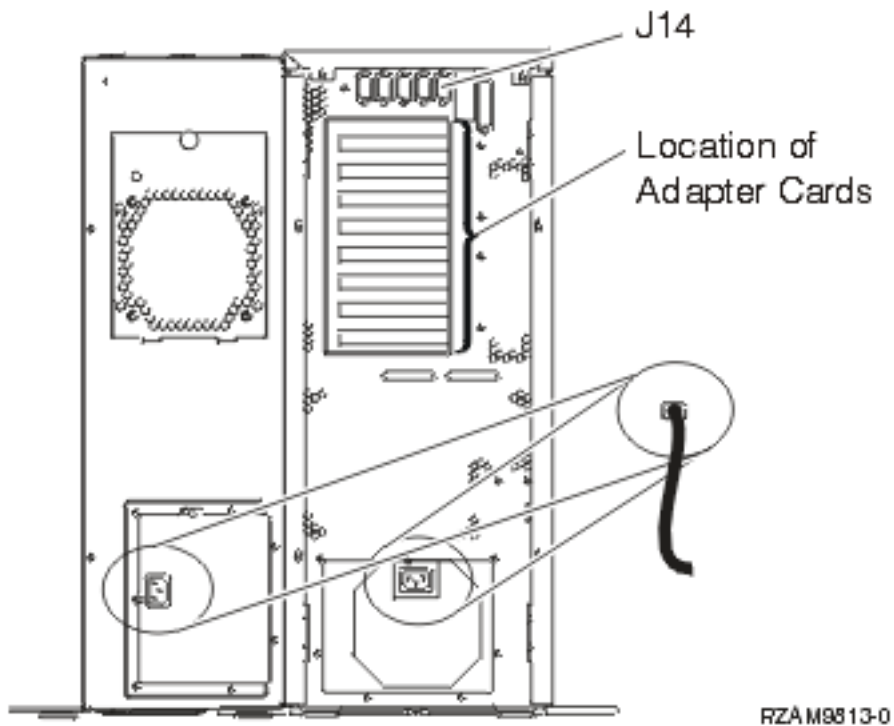
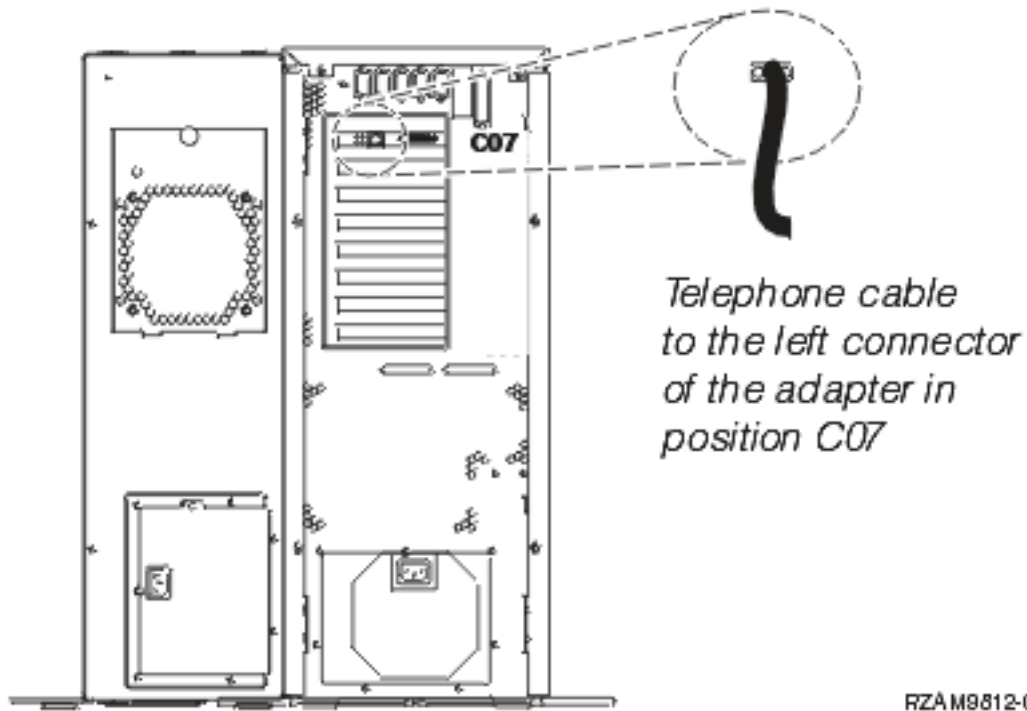

Connecting the twinaxial cable

To connect the twinaxial cable, follow these instructions.

1. Look at card positions C06 through C02 on the back of the server. Locate the position that contains card 2746. This is your twinaxial adapter card. If more than one position contains card 2746, then select the card in position C06.

2. Locate the 8-port twinaxial attachment cable (PN 21F5093). Attach the cable to the connector on the 2746 twinaxial adapter.
3. Connect a twinaxial cable from the workstation that you are using as the system console to port 0 on the 8-port twinaxial attachment cable.

Note: The workstation address of your console must be set to 0. To set the address, refer to the reference material that was included with your workstation.

4. Continue with the next task.

Connecting the electronic customer support cable

To connect the electronic customer support cable, follow these instructions.

Are you installing electronic customer support?

- **No:** Continue with the next task.
- **Yes**

1. Connect a telephone cable to the left connector of the adapter located in position C07.
2. Connect the other end of the telephone cable to an analog telephone jack.

Electronic customer support helps automate management of your server and streamline your support. Find out more about electronic customer support by looking at the IBM System i Technical Support





Advantage information included with your server, or go to the Support for IBM System i  Web site. Electronic customer support can be configured using the *iSeries Setup and Operations* CD-ROM that came with your server.

Continue with the next task.

Cabling the expansion unit

To cable the expansion unit, follow these instructions.

Note: Do not plug the expansion-unit power cord into the power outlet as directed by the following documents.

- Setting Up Your 0578, 5074, 5078, or 5079 Expansion Unit 
- Setting Up Your 5075 Expansion Unit 
- Setting Up Your 5065 or 5066 Expansion Unit 
- Setting Up Your 0588, 0595, 5088, 5094, 5095 or 5294 Expansion Unit 

After you have set up the expansion unit, continue with the next task.

Connecting the power cords

To connect the power cords, follow these instructions.

If you have a 4758 PCI Cryptographic Coprocessor card to install, go to the instructions that came with the card. This card was shipped in a separate box. Return here after the card is installed.

Are you installing an uninterruptible power supply?

- **No:** Connect the server power cords to the server.

Note: Do not plug the power cord into the power outlet. Do not turn on your server.

- **Yes:** Connect the power control cable for the uninterruptible power supply to J14. Do not plug the power cord of the uninterruptible power supply into the outlet and do not turn on your server. For instructions to complete the installation of the uninterruptible power supply, go to the Web site

Continue with the next task.

Connecting external cables

To connect external cables, follow these instructions.

If you do not have any external cables to connect to the adapter cards on the back of your server or expansion unit, continue with the next task.

1. Use this table to connect the cables to the matching adapters on the back of your server. You might need to connect more than one cable.

Note: If the cable did not come with your server, then you need to supply it.

Table 5. Cables and adapters





Cables and connectors	Adapter type numbers	Adapters (located on the back of the server)
PCI two-line WAN		
44H7xxx or 97H73xx 	4745/2745/2742	PCI Two-line WAN Input/Output Adapter 
44H7xxx, 97H73xx, or 44H748x  Integrated modem 87G62xx, 21H49xx, or 75G38xx 	2793/2794/2771	PCI Two-line WAN with Modem Input/Output Adapter 
PCI dual WAN		
Integrated modem 87G62xx, 21H49xx, or 75G38xx 	2772/2773	PCI Dual WAN with Modem Input/Output Adapter 
PCI twinaxial		
Part number 12F5093 	4746/9746/2746	PCI Twinaxial Workstation Controller Input/Output Adapter 
PCI token-ring		

Table 5. Cables and adapters (continued)



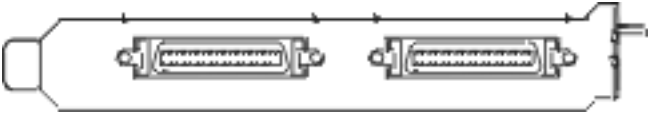

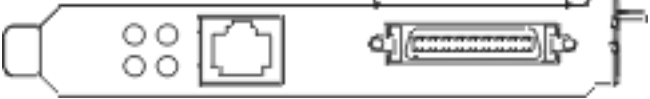

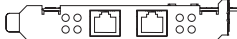
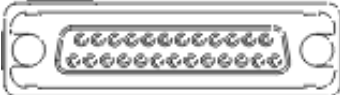
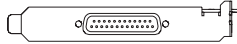



Cables and connectors	Adapter type numbers	Adapters (located on the back of the server)
<p>RJ45 Token-ring</p>  <p>Filter P75G5958 or 75G2865</p>  <p>6339098</p> 	2744/4959	<p>PCI 4/16/100 Mbps Token-Ring Input/Output Adapter</p> 
PCI quad		
	2805/2806	<p>PCI Quad Modem Input/Output Adapter</p> 
	6312	<p>PCI Quad Digital Trunk Adapter</p> 
Ethernet		
<p>RJ45 Ethernet</p> 	2838/2849	<p>PCI 100/10 Mbps Ethernet Input/Output Adapter</p> 
	5700	<p>PCI 1 Gbps Ethernet Input/Output Adapter</p> 
	5701	<p>PCI 1 Gbps Ethernet UTP Input/Output Adapter</p> 
	5706	<p>PCI 1 Gbps Ethernet TX Input/Output Adapter</p> 
	5707	<p>PCI 1 Gbps Ethernet SX Input/Output Adapter</p> 
	5718	<p>PCI 10 Gbps Ethernet Input/Output Adapter</p> 
Server cards		

Table 5. Cables and adapters (continued)



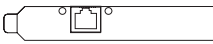
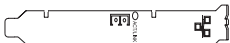

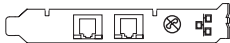
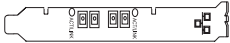

Cables and connectors	Adapter type numbers	Adapters (located on the back of the server)
<p>Part number 45H2433</p> <p>44H8677 connects to cable 45H2433</p>  <p>Video extension cable, 44H8676</p> 	2891/2892	<p>Netfinity Server Card</p> 
	4810/9710	<p>Integrated xSeries server card</p> 
	4821/9712	<p>Integrated xSeries server card</p>
RAID disk unit controllers		
	2757	<p>PCI Ultra RAID Disk Unit Controller</p>
	2780	<p>PCI-X Ultra4 RAID Disk Unit Controller</p>
	5703/4778	<p>PCI-X RAID Disk Unit Controller</p> 
	5709	<p>RAID Enabler Card</p>
Fibre channel disk unit controllers		
	2787	<p>PCI-X Fibre Channel Disk Unit Controller</p>
PCI cryptography		
	4801/4758-023	<p>PCI Cryptographic Coprocessor</p> 
	4805/2058	<p>PCI Cryptographic Accelerator</p>
PCI-X tape unit controllers		
	5704	<p>PCI-X Fibre Channel Tape Unit Controller</p> 
	5702/5712/5715	<p>PCI-X U320 Tape/Disk Unit Controller</p> 
Bus adapters		
	2886	<p>Optical Bus Adapter</p> 

Table 5. Cables and adapters (continued)

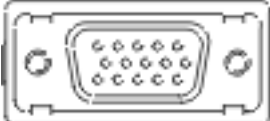
Cables and connectors	Adapter type numbers	Adapters (located on the back of the server)
	2887	HSL-2 Bus Adapter 
	6417/28E7	HSL-2/RIO-G Bus Adapter 

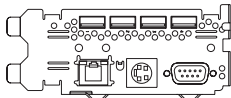
2. Connect the other end of the external cables to a network or device.
3. Continue with the next task.

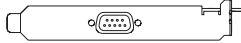
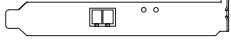
Turning on your server

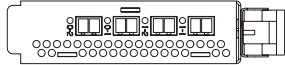
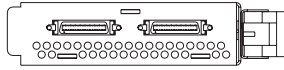
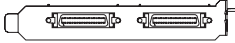
Before you turn on your server, complete these steps.

1. Plug in and turn on your console.
2. Plug in your server or uninterruptible power supply.
3. Plug in any attached expansion units.
4. Open the control panel door on the front of the server. The control panel should be lit and display 01 BN V=F. The server is not yet powered on.

Note: If 01 BN V=F is not on the display, you might need to change the mode. If you need these instructions, go to the Accessing control panel functions topic in the information center.

5. Press the white Power On button. There is a short delay until the server starts to turn on. It takes 5 to 20 minutes. If your server uses the twinaxial console, 01 BN V=F appears on the control panel when the server is powered on. If your server uses Operations Console, 01 BN V=F or A900 2000, which indicates the console is not connected yet, appears on the control panel when the server is powered on.

You have cabled your server.

6. Continue with the next task.

Note: If you plan to install any Linux specific hardware, or if you plan to create logical partitions on your iSeries, you might need to add or move some hardware, such as network I/O adapters, at this time. If you are unsure as to where to put the new or changed hardware, run the LPAR

Validation Tool (LVT) . You can find information about LPAR in the Logical partitions topic and additional information in the Linux in a logical partition topic of the information center.

Related information

Accessing control panel functions

Logical partitions

Linux in a logical partition

Setting up your server

To set up your server, follow these instructions.

If you have a PC connected to the LAN, you can use EZ-Setup on the *iSeries Setup and Operations* CD-ROM to complete your server setup.

If you do not have a PC connected to the LAN, go to Setting Up Your Twinaxial System  to continue with your server setup.

Cabling a model 800 or model 810 and twinaxial console without an expansion unit

To connect the cables to your server and to the console, follow these instructions.

Print this topic using the Print key.

Note: If you are installing your server in a rack, see the Installing System i features topic.

Attach the 8-port Twinaxial cable to the 2746 connector in position C06 through C02.

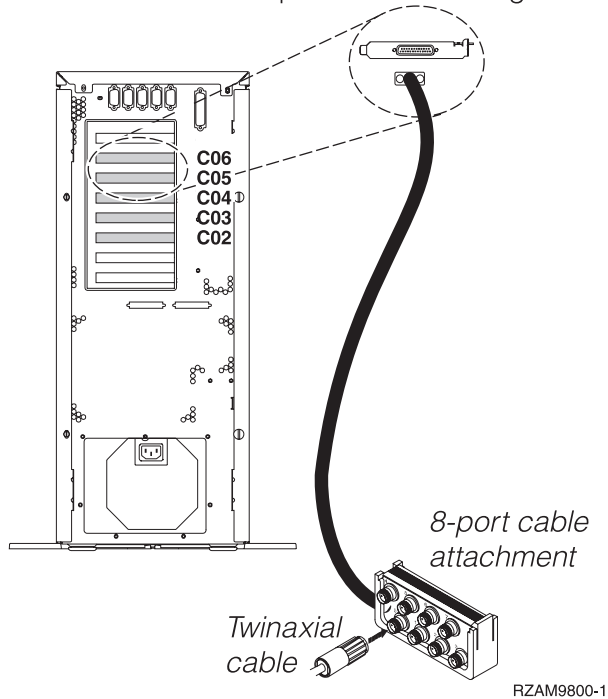

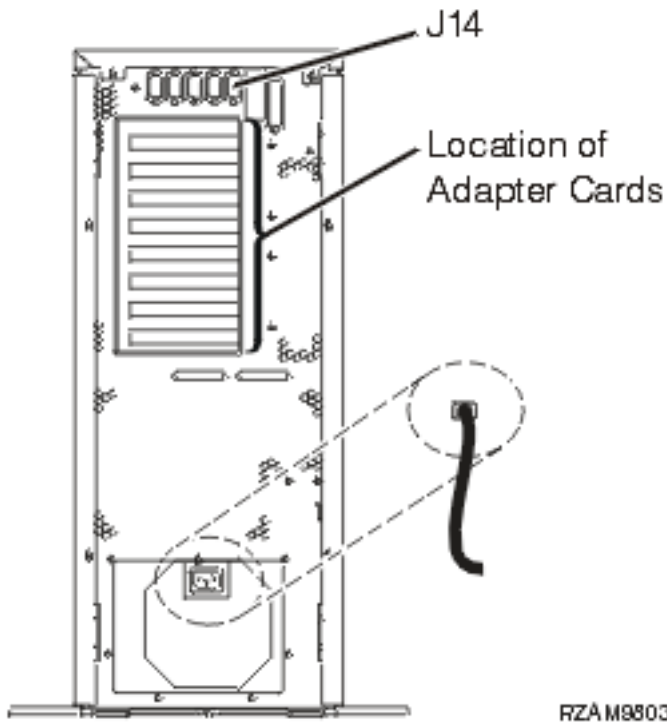
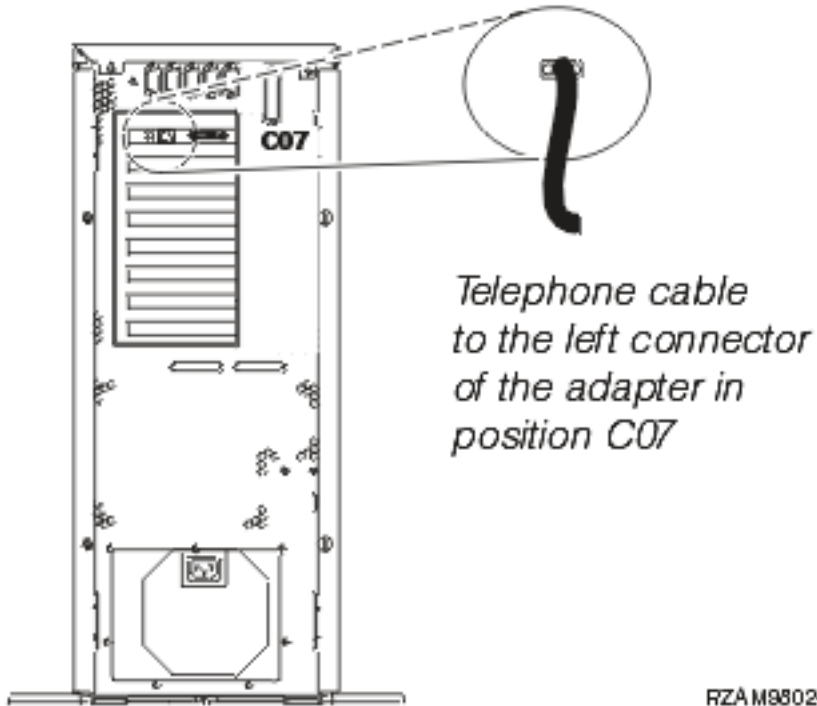

Connecting the twinaxial cable

To connect the twinaxial cable, follow these instructions.

1. Look at card positions C06 through C02 on the back of the server. Locate the position that contains card 2746. This is your twinaxial adapter card. If more than one position contains card 2746, then select the card in position C06.

2. Locate the 8-port twinaxial attachment cable (PN 21F5093). Attach the cable to the connector on the 2746 twinaxial adapter.
3. Connect a twinaxial cable from the workstation that you are using as the system console to port 0 on the 8-port twinaxial attachment cable.

Note: The workstation address of your console must be set to 0. To set the address, refer to the reference material that was included with your workstation.

4. Continue with the next task.

Connecting the electronic customer support cable

To connect the electronic customer support cable, follow these instructions.

Are you installing electronic customer support?

- **No:** Continue with the next task.
- **Yes**

1. Connect a telephone cable to the left connector of the adapter located in position C07.
2. Connect the other end of the telephone cable to an analog telephone jack.

Electronic customer support helps automate management of your server and streamline your support. Find out more about electronic customer support by looking at the IBM System i Technical Support

Advantage information included with your server, or go to the Support for IBM System i  Web site. Electronic customer support can be configured using the *iSeries Setup and Operations* CD-ROM that came with your server.

Continue with the next task.

Connecting the power cords

To connect the power cords, follow these instructions.

If you have a 4758 PCI Cryptographic Coprocessor card to install, go to the instructions that came with the card. This card was shipped in a separate box. Return here after the card is installed.

Are you installing an uninterruptible power supply?

- **No:** Connect the server power cords to the server.

Note: Do not plug the power cord into the power outlet. Do not turn on your server.

- **Yes:** Connect the power control cable for the uninterruptible power supply to J14. Do not plug the power cord of the uninterruptible power supply into the outlet and do not turn on your server. For instructions to complete the installation of the uninterruptible power supply, go to the Web site Powerware UPS Solutions for IBM

(<http://www.oem.powerware.com/ibm-ups/Products/9910Solutions/ina.asp>) .

Continue with the next task.

Connecting external cables

To connect external cables, follow these instructions.

If you do not have any external cables to connect to the adapter cards on the back of your server or expansion unit, continue with the next task.

1. Use this table to connect the cables to the matching adapters on the back of your server. You might need to connect more than one cable.

Note: If the cable did not come with your server, then you need to supply it.

Table 6. Cables and adapters







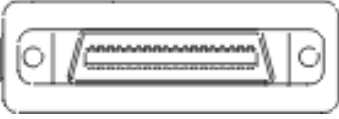
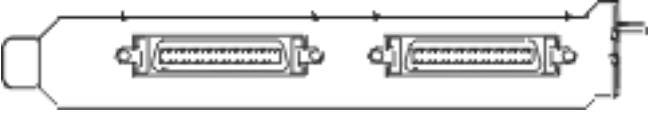

Cables and connectors	Adapter type numbers	Adapters (located on the back of the server)
PCI two-line WAN		
44H7xxx or 97H73xx 	4745/2745/2742	PCI Two-line WAN Input/Output Adapter 
44H7xxx, 97H73xx, or 44H748x  Integrated modem 87G62xx, 21H49xx, or 75G38xx 	2793/2794/2771	PCI Two-line WAN with Modem Input/Output Adapter 
PCI dual WAN		
Integrated modem 87G62xx, 21H49xx, or 75G38xx 	2772/2773	PCI Dual WAN with Modem Input/Output Adapter 
PCI twinaxial		
Part number 12F5093 	4746/9746/2746	PCI Twinaxial Workstation Controller Input/Output Adapter 
PCI token-ring		
RJ45 Token-ring  Filter P75G5958 or 75G2865  6339098 	2744/4959	PCI 4/16/100 Mbps Token-Ring Input/Output Adapter 
PCI quad		

Table 6. Cables and adapters (continued)



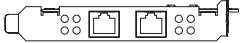
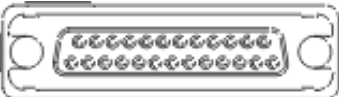



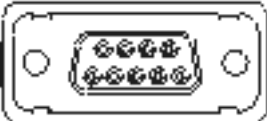
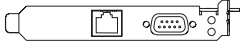

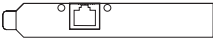

Cables and connectors	Adapter type numbers	Adapters (located on the back of the server)
	2805/2806	PCI Quad Modem Input/Output Adapter 
	6312	PCI Quad Digital Trunk Adapter 
Ethernet		
RJ45 Ethernet 	2838/2849	PCI 100/10 Mbps Ethernet Input/Output Adapter 
	5700	PCI 1 Gbps Ethernet Input/Output Adapter 
	5701	PCI 1 Gbps Ethernet UTP Input/Output Adapter 
	5706	PCI 1 Gbps Ethernet TX Input/Output Adapter 
	5707	PCI 1 Gbps Ethernet SX Input/Output Adapter 
	5718	PCI 10 Gbps Ethernet Input/Output Adapter 
Server cards		
Part number 45H2433 44H8677 connects to cable 45H2433  Video extension cable, 44H8676 	2891/2892	Netfinity Server Card 
	4810/9710	Integrated xSeries server card 
	4821/9712	Integrated xSeries server card
RAID disk unit controllers		
	2757	PCI Ultra RAID Disk Unit Controller

Table 6. Cables and adapters (continued)

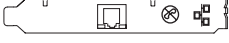
Cables and connectors	Adapter type numbers	Adapters (located on the back of the server)
	2780	PCI-X Ultra4 RAID Disk Unit Controller
	5703/4778	PCI-X RAID Disk Unit Controller 
	5709	RAID Enabler Card
Fibre channel disk unit controllers		
	2787	PCI-X Fibre Channel Disk Unit Controller
PCI cryptography		
	4801/4758-023	PCI Cryptographic Coprocessor 
	4805/2058	PCI Cryptographic Accelerator
PCI-X tape unit controllers		
	5704	PCI-X Fibre Channel Tape Unit Controller 
	5702/5712/5715	PCI-X U320 Tape/Disk Unit Controller 
Bus adapters		
	2886	Optical Bus Adapter 
	2887	HSL-2 Bus Adapter 
	6417/28E7	HSL-2/RIO-G Bus Adapter 

2. Connect the other end of the external cables to a network or device.
3. Continue with the next task.

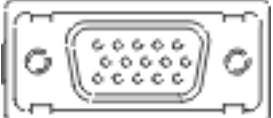
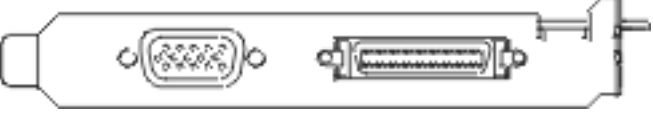
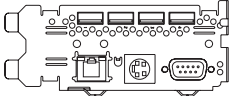
Turning on your server

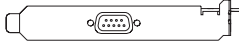
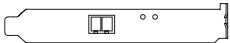
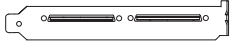
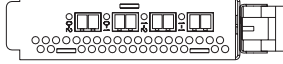
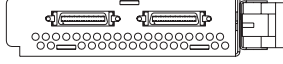
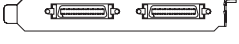
Before you turn on your server, complete these steps.

1. Plug in and turn on your console.
2. Plug in your server or uninterruptible power supply.
3. Plug in any attached expansion units.
4. Open the control panel door on the front of the server. The control panel should be lit and display 01 BN V=F. The server is not yet powered on.

Note: If 01 BN V=F is not on the display, you might need to change the mode. If you need these instructions, go to the Accessing control panel functions topic in the information center.

5. Press the white Power On button. There is a short delay until the server starts to turn on. It takes 5 to 20 minutes. If your server uses the twinaxial console, 01 BN V=F appears on the control panel when

the server is powered on. If your server uses Operations Console, 01 BN V=F or A900 2000, which indicates the console is not connected yet, appears on the control panel when the server is powered on.

You have cabled your server.

6. Continue with the next task.

Note: If you plan to install any Linux specific hardware, or if you plan to create logical partitions on your iSeries, you might need to add or move some hardware, such as network I/O adapters, at this time. If you are unsure as to where to put the new or changed hardware, run the LPAR

Validation Tool (LVT) . You can find information about LPAR in the Logical partitions topic and additional information in the Linux in a logical partition topic of the information center.

Setting up your server

To set up your server, follow these instructions.

If you have a PC connected to the LAN, you can use EZ-Setup on the *iSeries Setup and Operations* CD-ROM to complete your server setup.

If you do not have a PC connected to the LAN, go to Setting Up Your Twinaxial System  to continue with your server setup.

Cabling a model 800 or model 810 with an expansion unit and Operations Console

To connect the cables to your server and to the console, follow these instructions.

Print this topic using the Print key.

Note: If you are installing your server in a rack, see the Installing System i features topic.

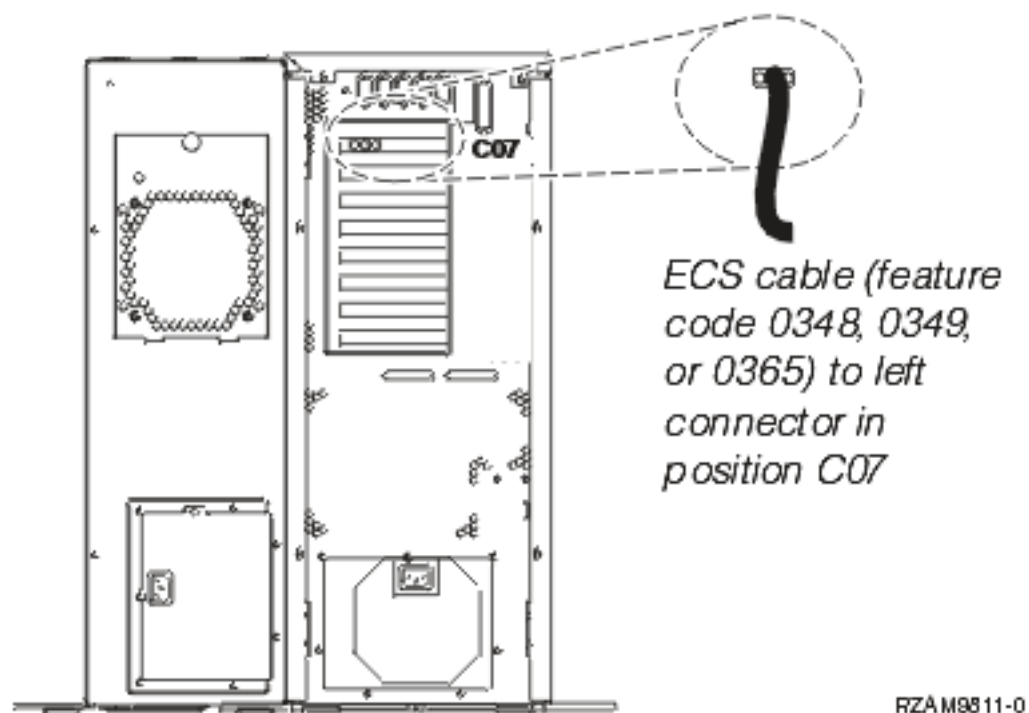
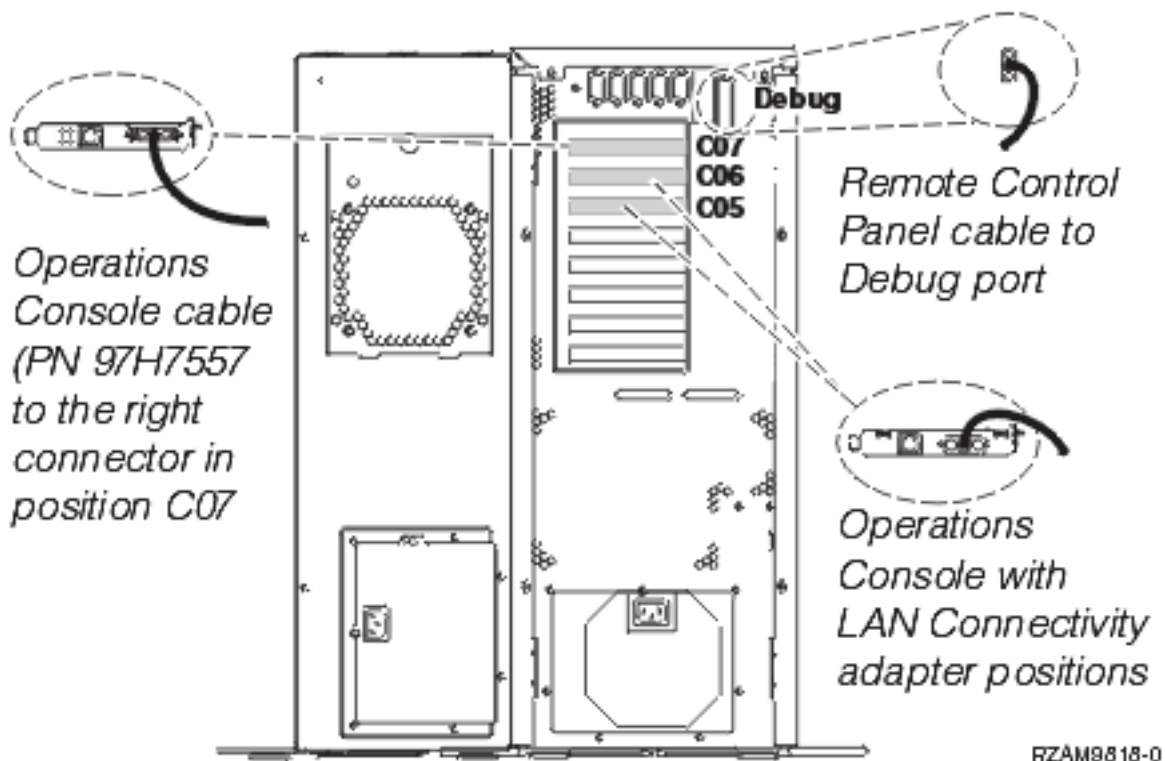

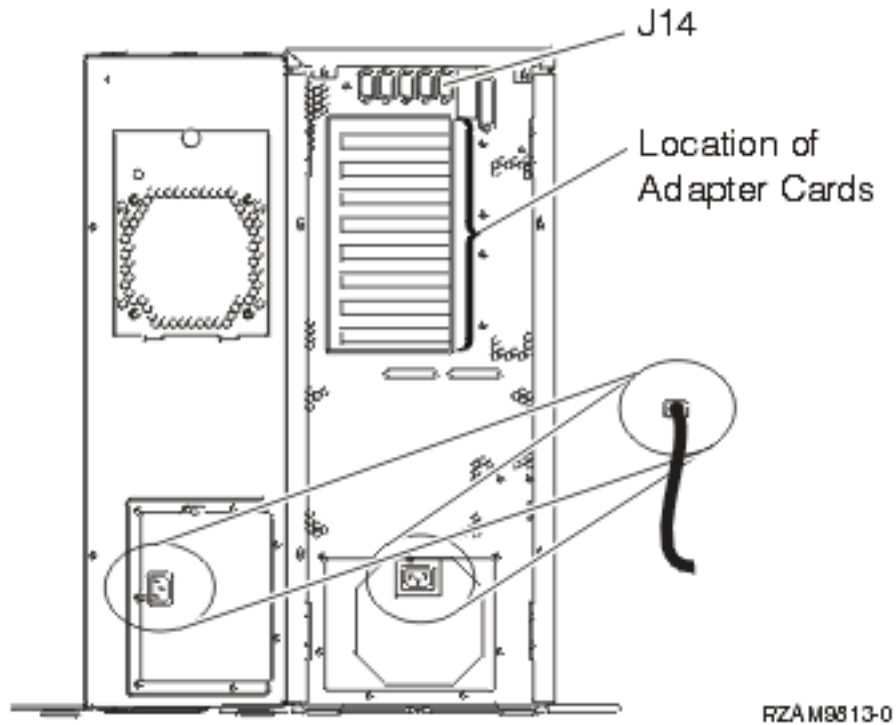

Connecting the Operations Console cable

To connect the Operations Console cable, follow these instructions.

1. Turn off and unplug the PC that is going to serve as the system console.
2. Locate the Operations Console cable (PN 97H7557). Connect the Operations Console cable to the right connector of the 2793 or 2794 adapter located in position C07 on the back of the server.

Are you using Operations Console with LAN connectivity?

- **No**

- a. Connect the other end of the Operations Console cable to the first or only communications (serial) port on the back of the PC being used as the console.
- b. Continue with the next task.

- **Yes**

If your primary choice is LAN connectivity, you do not need to connect the Operations Console cables to your PC at this time. If you develop a problem, you can connect these cables to the PC and set up Operations Console. See Operations Console.

- a. Connect a network cable from the PC that is going to serve as the system console to your local network. Connect a network cable from your local network to the adapter in position C06 or C05.
- b. Continue with the next task.

Connecting the electronic customer support cable

To connect the electronic customer support cable, follow these instructions.

Are you installing electronic customer support?

- **No:** Continue with the next task.

- **Yes**

1. Connect a telephone cable to the left connector of the adapter located in position C07.
2. Connect the other end of the telephone cable to an analog telephone jack.

Electronic customer support helps automate management of your server and streamline your support. Find out more about electronic customer support by looking at the IBM System i Technical Support





Advantage information included with your server, or go to the Support for IBM System i  Web site. Electronic customer support can be configured using the *iSeries Setup and Operations* CD-ROM that came with your server.

Continue with the next task.

Cabling the expansion unit

To cable the expansion unit, follow these instructions.

Note: Do not plug the expansion-unit power cord into the power outlet as directed by the following documents.

- Setting Up Your 0578, 5074, 5078, or 5079 Expansion Unit 
- Setting Up Your 5075 Expansion Unit 
- Setting Up Your 5065 or 5066 Expansion Unit 
- Setting Up Your 0588, 0595, 5088, 5094, 5095 or 5294 Expansion Unit 

After you have set up the expansion unit, continue with the next task.

Connecting the power cords

To connect the power cords, follow these instructions.

If you have a 4758 PCI Cryptographic Coprocessor card to install, go to the instructions that came with the card. This card was shipped in a separate box. Return here after the card is installed.

Are you installing an uninterruptible power supply?

- **No:** Connect the server power cords to the server.

Note: Do not plug the power cord into the power outlet. Do not turn on your server.

- **Yes:** Connect the power control cable for the uninterruptible power supply to J14. Do not plug the power cord of the uninterruptible power supply into the outlet and do not turn on your server. For instructions to complete the installation of the uninterruptible power supply, go to the Web site Powerware UPS Solutions for IBM

(<http://www.oem.powerware.com/ibm-ups/Products/9910Solutions/ina.asp>) .

Continue with the next task.

Connecting external cables

To connect external cables, follow these instructions.

If you do not have any external cables to connect to the adapter cards on the back of your server or expansion unit, continue with the next task.

1. Use this table to connect the cables to the matching adapters on the back of your server. You might need to connect more than one cable.

Note: If the cable did not come with your server, then you need to supply it.

Table 7. Cables and adapters







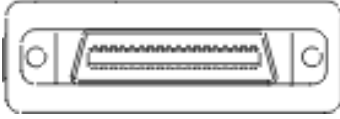
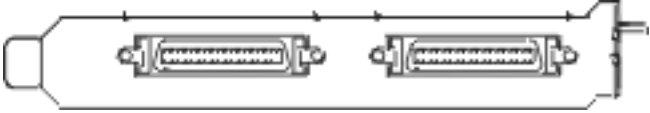
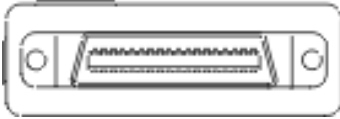

Cables and connectors	Adapter type numbers	Adapters (located on the back of the server)
PCI two-line WAN		
44H7xxx or 97H73xx 	4745/2745/2742	PCI Two-line WAN Input/Output Adapter 
44H7xxx, 97H73xx, or 44H748x  Integrated modem 87G62xx, 21H49xx, or 75G38xx 	2793/2794/2771	PCI Two-line WAN with Modem Input/Output Adapter 
PCI dual WAN		
Integrated modem 87G62xx, 21H49xx, or 75G38xx 	2772/2773	PCI Dual WAN with Modem Input/Output Adapter 
PCI twinaxial		
Part number 12F5093 	4746/9746/2746	PCI Twinaxial Workstation Controller Input/Output Adapter 
PCI token-ring		
RJ45 Token-ring  Filter P75G5958 or 75G2865  6339098 	2744/4959	PCI 4/16/100 Mbps Token-Ring Input/Output Adapter 
PCI quad		

Table 7. Cables and adapters (continued)



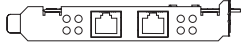
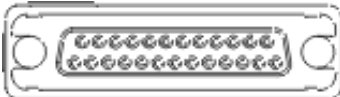



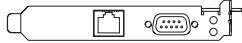



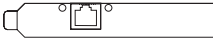

Cables and connectors	Adapter type numbers	Adapters (located on the back of the server)
	2805/2806	PCI Quad Modem Input/Output Adapter 
	6312	PCI Quad Digital Trunk Adapter 
Ethernet		
RJ45 Ethernet 	2838/2849	PCI 100/10 Mbps Ethernet Input/Output Adapter 
	5700	PCI 1 Gbps Ethernet Input/Output Adapter 
	5701	PCI 1 Gbps Ethernet UTP Input/Output Adapter 
	5706	PCI 1 Gbps Ethernet TX Input/Output Adapter 
	5707	PCI 1 Gbps Ethernet SX Input/Output Adapter 
	5718	PCI 10 Gbps Ethernet Input/Output Adapter 
Server cards		
Part number 45H2433 44H8677 connects to cable 45H2433  Video extension cable, 44H8676 	2891/2892	Netfinity Server Card 
	4810/9710	Integrated xSeries server card 
	4821/9712	Integrated xSeries server card
RAID disk unit controllers		
	2757	PCI Ultra RAID Disk Unit Controller

Table 7. Cables and adapters (continued)

Cables and connectors	Adapter type numbers	Adapters (located on the back of the server)
	2780	PCI-X Ultra4 RAID Disk Unit Controller
	5703/4778	PCI-X RAID Disk Unit Controller 
	5709	RAID Enabler Card
Fibre channel disk unit controllers		
	2787	PCI-X Fibre Channel Disk Unit Controller
PCI cryptography		
	4801/4758-023	PCI Cryptographic Coprocessor 
	4805/2058	PCI Cryptographic Accelerator
PCI-X tape unit controllers		
	5704	PCI-X Fibre Channel Tape Unit Controller 
	5702/5712/5715	PCI-X U320 Tape/Disk Unit Controller 
Bus adapters		
	2886	Optical Bus Adapter 
	2887	HSL-2 Bus Adapter 
	6417/28E7	HSL-2/RIO-G Bus Adapter 

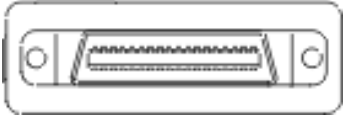
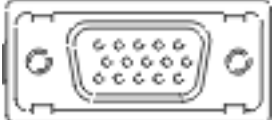
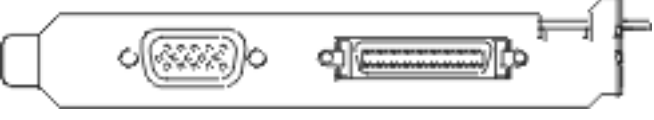
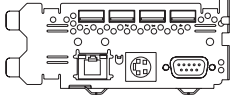
2. Connect the other end of the external cables to a network or device.
3. Continue with the next task.

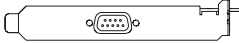
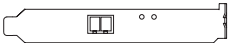
Turning on your server

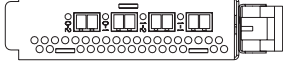
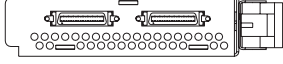
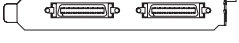
Before you turn on your server, complete these steps.

1. Plug in and turn on your console.
2. Plug in your server or uninterruptible power supply.
3. Plug in any attached expansion units.
4. Open the control panel door on the front of the server. The control panel should be lit and display 01 BN V=F. The server is not yet powered on.

Note: If 01 BN V=F is not on the display, you might need to change the mode. If you need these instructions, go to the Accessing control panel functions topic in the information center.

5. Press the white Power On button. There is a short delay until the server starts to turn on. It takes 5 to 20 minutes. If your server uses the twinaxial console, 01 BN V=F appears on the control panel when

the server is powered on. If your server uses Operations Console, 01 BN V=F or A900 2000, which indicates the console is not connected yet, appears on the control panel when the server is powered on.

You have cabled your server.

6. Continue with the next task.

Note: If you plan to install any Linux specific hardware, or if you plan to create logical partitions on your iSeries, you might need to add or move some hardware, such as network I/O adapters, at this time. If you are unsure as to where to put the new or changed hardware, run the LPAR

Validation Tool (LVT) . You can find information about LPAR in the Logical partitions topic and additional information in the Linux in a logical partition topic of the information center.

Setting up your server

To continue to set up your server, return to EZ-Setup on the *iSeries Setup and Operations* CD-ROM.

Cabling a model 800 or model 810 and Operations Console without an expansion unit

To connect the cables to your server and to the console, follow these instructions.

Print this topic using the Print key.

Note: If you are installing your server in a rack, see the *Installing System i features* topic.

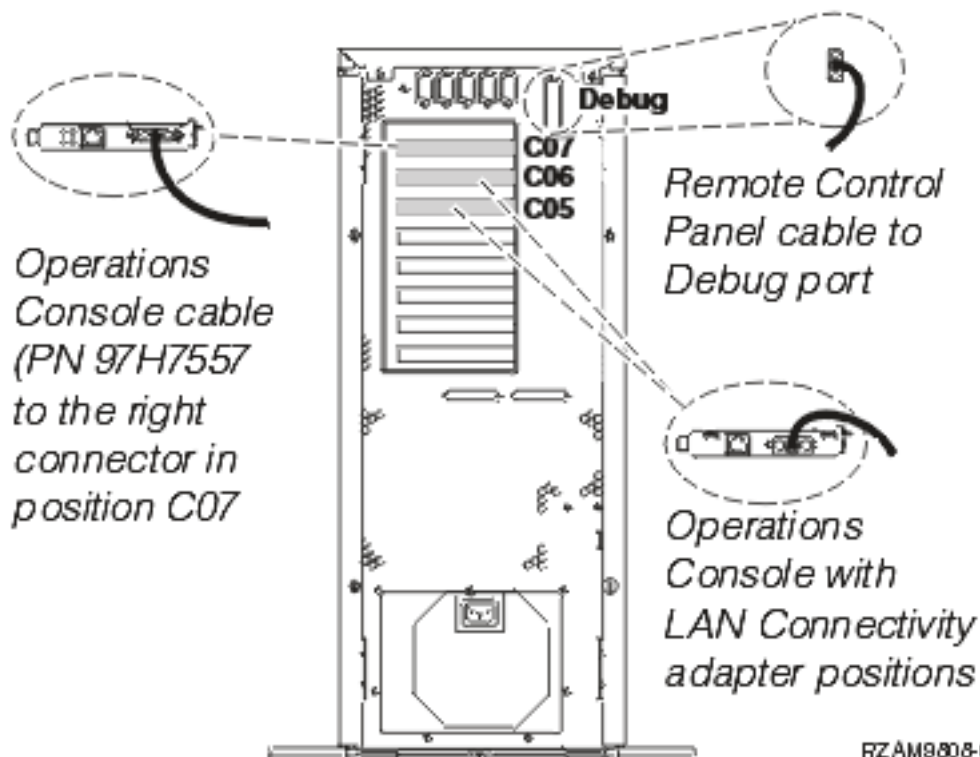

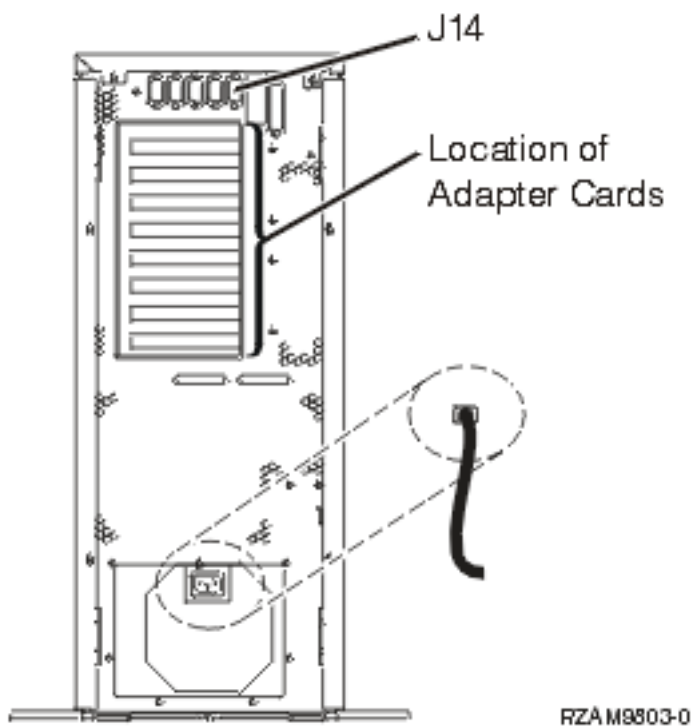
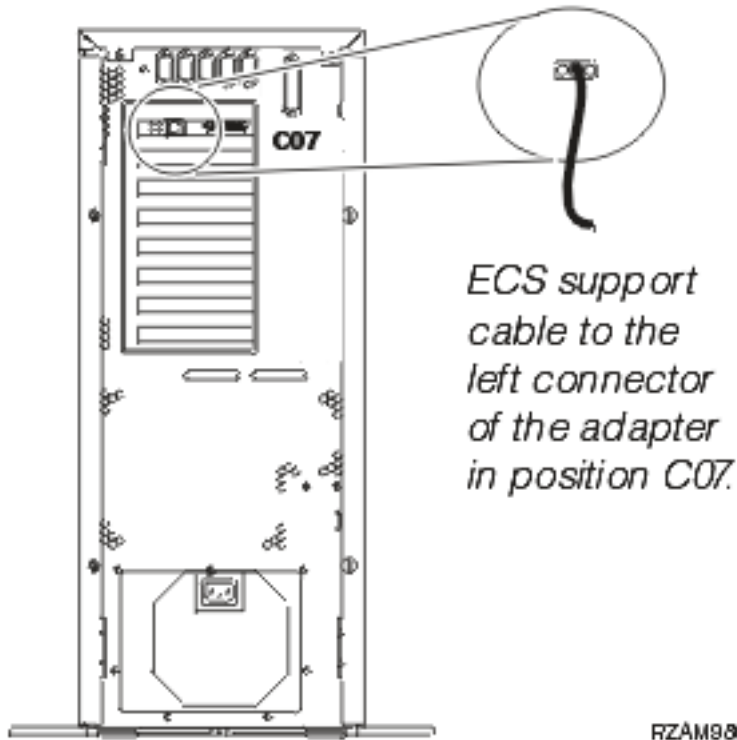

Connecting the Operations Console cable

To connect the Operations Console cable, follow these instructions.

1. Turn off and unplug the PC that is going to serve as the system console.
2. Locate the Operations Console cable (PN 97H7557). Connect the Operations Console cable to the right connector of the 2793 or 2794 adapter located in position C07 on the back of the server.

Are you using Operations Console with LAN connectivity?

- **No**
 - a. Connect the other end of the Operations Console cable to the first or only communications (serial) port on the back of the PC being used as the console.
 - b. Continue with the next task.

- **Yes**

If your primary choice is LAN connectivity, you do not need to connect the Operations Console cables to your PC at this time. If you develop a problem, you can connect these cables to the PC and set up Operations Console. See Operations Console.

- a. Connect a network cable from the PC that is going to serve as the system console to your local network. Connect a network cable from your local network to the adapter in position C06 or C05.
- b. Continue with the next task.

Connecting the electronic customer support cable

To connect the electronic customer support cable, follow these instructions.

Are you installing electronic customer support?

- **No:** Continue with the next task.
- **Yes**

1. Connect a telephone cable to the left connector of the adapter located in position C07.
2. Connect the other end of the telephone cable to an analog telephone jack.

Electronic customer support helps automate management of your server and streamline your support. Find out more about electronic customer support by looking at the IBM System i Technical Support

Advantage information included with your server, or go to the Support for IBM System i  Web site. Electronic customer support can be configured using the *iSeries Setup and Operations* CD-ROM that came with your server.

Continue with the next task.

Connecting the power cords

To connect the power cords, follow these instructions.

If you have a 4758 PCI Cryptographic Coprocessor card to install, go to the instructions that came with the card. This card was shipped in a separate box. Return here after the card is installed.

Are you installing an uninterruptible power supply?

- **No:** Connect the server power cords to the server.

Note: Do not plug the power cord into the power outlet. Do not turn on your server.

- **Yes:** Connect the power control cable for the uninterruptible power supply to J14. Do not plug the power cord of the uninterruptible power supply into the outlet and do not turn on your server. For instructions to complete the installation of the uninterruptible power supply, go to the Web site Powerware UPS Solutions for IBM

(<http://www.oem.powerware.com/ibm-ups/Products/9910Solutions/ina.asp>) .

Continue with the next task.

Connecting external cables

To connect external cables, follow these instructions.

If you do not have any external cables to connect to the adapter cards on the back of your server or expansion unit, continue with the next task.

1. Use this table to connect the cables to the matching adapters on the back of your server. You might need to connect more than one cable.

Note: If the cable did not come with your server, then you need to supply it.

Table 8. Cables and adapters







Cables and connectors	Adapter type numbers	Adapters (located on the back of the server)
PCI two-line WAN		
44H7xxx or 97H73xx 	4745/2745/2742	PCI Two-line WAN Input/Output Adapter 
44H7xxx, 97H73xx, or 44H748x  Integrated modem 87G62xx, 21H49xx, or 75G38xx 	2793/2794/2771	PCI Two-line WAN with Modem Input/Output Adapter 
PCI dual WAN		
Integrated modem 87G62xx, 21H49xx, or 75G38xx 	2772/2773	PCI Dual WAN with Modem Input/Output Adapter 
PCI twinaxial		
Part number 12F5093 	4746/9746/2746	PCI Twinaxial Workstation Controller Input/Output Adapter 
PCI token-ring		

Table 8. Cables and adapters (continued)

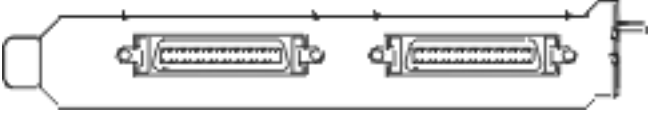
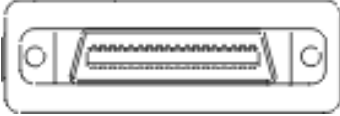

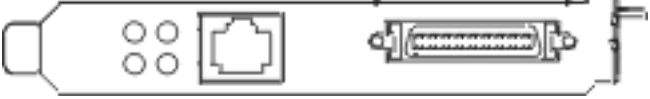

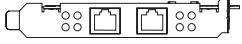

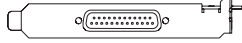

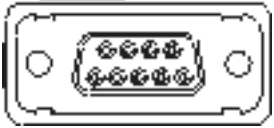

Cables and connectors	Adapter type numbers	Adapters (located on the back of the server)
<p>RJ45 Token-ring</p>  <p>Filter P75G5958 or 75G2865</p>  <p>6339098</p> 	2744/4959	<p>PCI 4/16/100 Mbps Token-Ring Input/Output Adapter</p> 
PCI quad		
	2805/2806	<p>PCI Quad Modem Input/Output Adapter</p> 
	6312	<p>PCI Quad Digital Trunk Adapter</p> 
Ethernet		
<p>RJ45 Ethernet</p> 	2838/2849	<p>PCI 100/10 Mbps Ethernet Input/Output Adapter</p> 
	5700	<p>PCI 1 Gbps Ethernet Input/Output Adapter</p> 
	5701	<p>PCI 1 Gbps Ethernet UTP Input/Output Adapter</p> 
	5706	<p>PCI 1 Gbps Ethernet TX Input/Output Adapter</p> 
	5707	<p>PCI 1 Gbps Ethernet SX Input/Output Adapter</p> 
	5718	<p>PCI 10 Gbps Ethernet Input/Output Adapter</p> 
Server cards		

Table 8. Cables and adapters (continued)



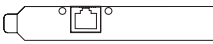
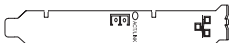

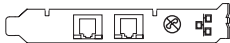
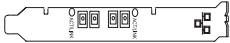
Cables and connectors	Adapter type numbers	Adapters (located on the back of the server)
<p>Part number 45H2433</p> <p>44H8677 connects to cable 45H2433</p>  <p>Video extension cable, 44H8676</p> 	2891/2892	<p>Netfinity Server Card</p> 
	4810/9710	<p>Integrated xSeries server card</p> 
	4821/9712	<p>Integrated xSeries server card</p>
RAID disk unit controllers		
	2757	<p>PCI Ultra RAID Disk Unit Controller</p>
	2780	<p>PCI-X Ultra4 RAID Disk Unit Controller</p>
	5703/4778	<p>PCI-X RAID Disk Unit Controller</p> 
	5709	<p>RAID Enabler Card</p>
Fibre channel disk unit controllers		
	2787	<p>PCI-X Fibre Channel Disk Unit Controller</p>
PCI cryptography		
	4801/4758-023	<p>PCI Cryptographic Coprocessor</p> 
	4805/2058	<p>PCI Cryptographic Accelerator</p>
PCI-X tape unit controllers		
	5704	<p>PCI-X Fibre Channel Tape Unit Controller</p> 
	5702/5712/5715	<p>PCI-X U320 Tape/Disk Unit Controller</p> 
Bus adapters		
	2886	<p>Optical Bus Adapter</p> 

Table 8. Cables and adapters (continued)

Cables and connectors	Adapter type numbers	Adapters (located on the back of the server)
	2887	HSL-2 Bus Adapter 
	6417/28E7	HSL-2/RIO-G Bus Adapter 

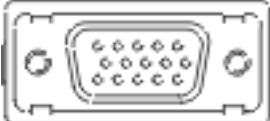
2. Connect the other end of the external cables to a network or device.
3. Continue with the next task.

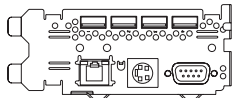
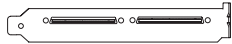
Turning on your server

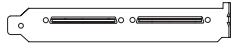
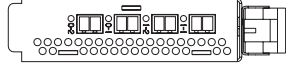
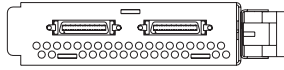
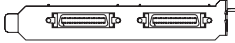
Before you turn on your server, complete these steps.

1. Plug in and turn on your console.
2. Plug in your server or uninterruptible power supply.
3. Plug in any attached expansion units.
4. Open the control panel door on the front of the server. The control panel should be lit and display 01 BN V=F. The server is not yet powered on.

Note: If 01 BN V=F is not on the display, you might need to change the mode. If you need these instructions, go to the Accessing control panel functions topic in the information center.

5. Press the white Power On button. There is a short delay until the server starts to turn on. It takes 5 to 20 minutes. If your server uses the twinaxial console, 01 BN V=F appears on the control panel when the server is powered on. If your server uses Operations Console, 01 BN V=F or A900 2000, which indicates the console is not connected yet, appears on the control panel when the server is powered on.

You have cabled your server.

6. Continue with the next task.

Note: If you plan to install any Linux specific hardware, or if you plan to create logical partitions on your iSeries, you might need to add or move some hardware, such as network I/O adapters, at this time. If you are unsure as to where to put the new or changed hardware, run the LPAR

Validation Tool (LVT) . You can find information about LPAR in the Logical partitions topic and additional information in the Linux in a logical partition topic of the information center.

Setting up your server

To continue to set up your server, return to EZ-Setup on the *iSeries Setup and Operations* CD-ROM.

Selecting the model 820 cabling instructions

Before you cable a server, select the cabling instructions that best match the server you are setting up.

Cabling a model 820 and twinaxial console with an expansion unit

To connect the cables to your server and to the console, follow these instructions.

Print this topic using the Print key.

Attach the 8-port Twinaxial cable to the 2746 connector in position C03, C04, or C11.

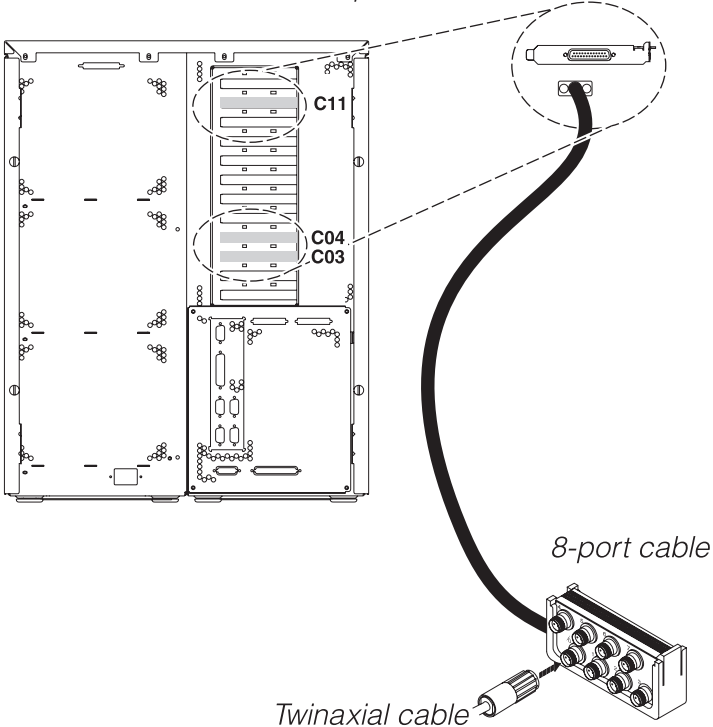

RZAM9700-3

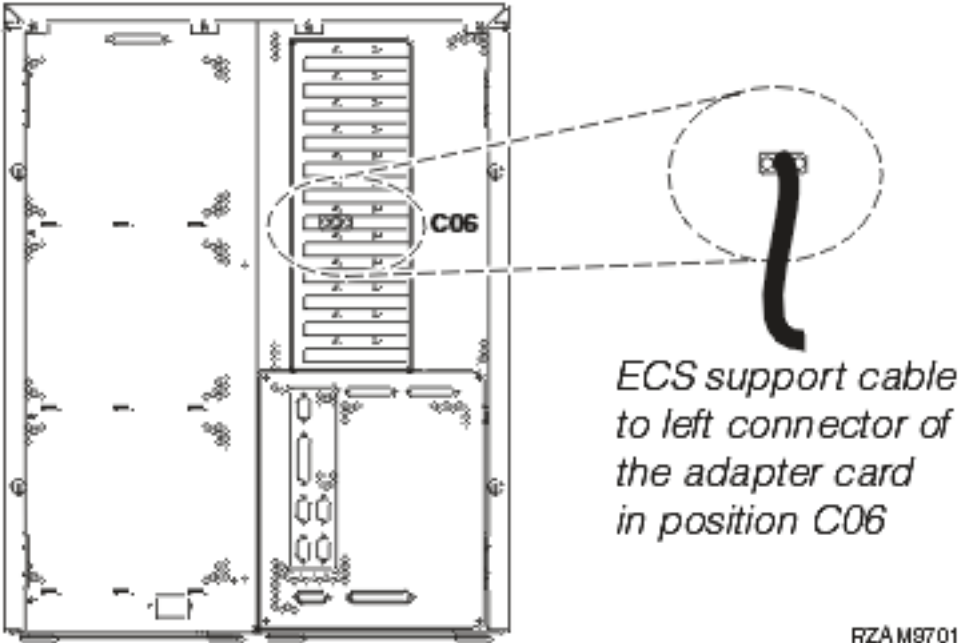

RZAM9701-1

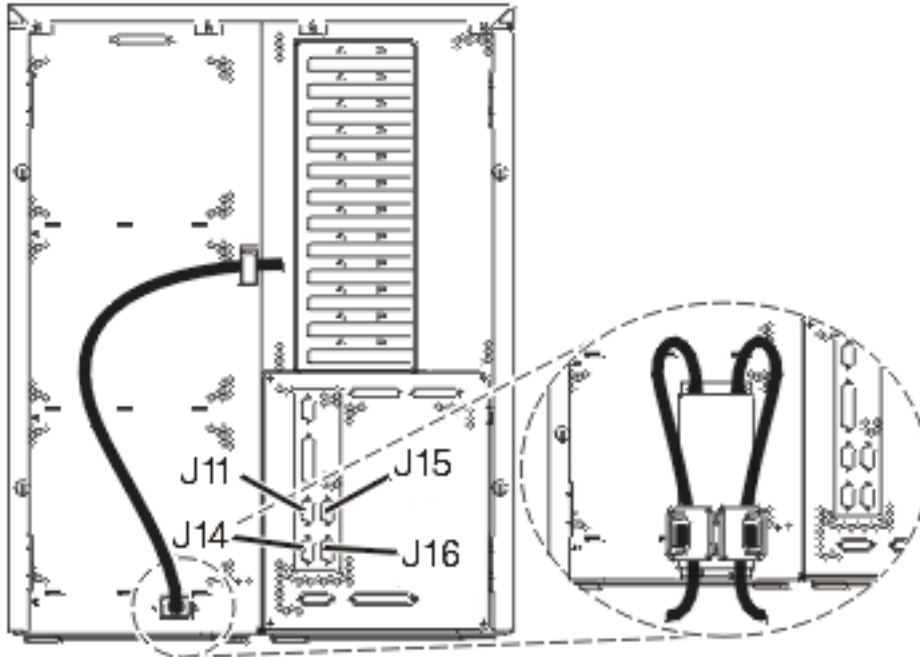

RZA M970 4-1

Connecting the twinaxial cable

To connect the twinaxial cable, follow these instructions.

1. Look at card positions C03, C04, and C11 on the back of the server. Locate the position that contains card 2746. This is your twinaxial adapter card. If more than one position contains card 2746, then select the card in position C04. If card 2746 is not in position C04, but it is in position C03 or C11, select the card in either location.
2. Locate the 8-port twinaxial attachment cable (PN 21F5093). Attach the cable to the connector on the 2746 twinaxial adapter. You must supply this twinaxial cable.
3. Connect a twinaxial cable from the workstation that you are using as the system console to port 0 on the 8-port twinaxial attachment cable.

Note: The workstation address of your console must be set to 0. To set the address, refer to the reference material that was included with your workstation.

4. Continue with the next task.

Connecting the electronic customer support cable

To connect the electronic customer support cable, follow these instructions.

Are you installing electronic customer support?

- **No:** Continue with the next task.
- **Yes:**

1. Connect a telephone cable to the left connector of the adapter located in position C06.
2. Connect the other end of the telephone cable to an analog telephone jack.

Electronic customer support helps automate management of your server and streamline your support. Find out more about electronic customer support by looking at the IBM System i Technical Support





Advantage information included with your server, or go to the Support for IBM System i  Web site. Electronic customer support can be configured using the *iSeries Setup and Operations* CD-ROM that came with your server.

Continue with the next task.

Cabling the expansion unit

To cable the expansion unit, follow these instructions.

Note: Do not plug the expansion-unit power cord into the power outlet as directed by the following documents.

- Setting Up Your 0578, 5074, 5078, or 5079 Expansion Unit 
- Setting Up Your 5075 Expansion Unit 
- Setting Up Your 5065 or 5066 Expansion Unit 
- Setting Up Your 0588, 0595, 5088, 5094, 5095 or 5294 Expansion Unit 

After you have set up the expansion unit and replaced the back cover, continue with the next task.

Connecting the power cords

Before you connect the power cords, complete these steps.

If you have a 4758 PCI Cryptographic Coprocessor card to install, go to the instructions that came with the card. This card was shipped in a separate box. Return here after the card is installed.

Note: If you are using two power cords, route them through the retainer clips as shown below after you connect them to the server.

Are you installing an uninterruptible power supply?

- **No:** Connect the server power cords to the server.

Note: Do not plug the power cord into the power outlet. Do not turn on your server.

Continue with the next task.

- **Yes:** Connect the power control cable for the uninterruptible power supply to J14. Do not plug the power cord of the uninterruptible power supply into the power outlet and do not turn on your server. For instructions to complete the installation of the uninterruptible power supply, go to the Web site Powerware UPS Solutions for IBM

(<http://www.oem.powerware.com/ibm-ups/Products/9910Solutions/ina.asp>) .

Continue with the next task.

Connecting external cables

To connect external cables, follow these instructions.

If you do not have any external cables to connect to the adapter cards on the back of your server or expansion unit, continue with the next task.

1. Use this table to connect the cables to the matching adapters on the back of your server. You might need to connect more than one cable.

Note: If the cable did not come with your server, then you need to supply it.

Table 9. Cables and adapters

Cables and connectors	Adapter type numbers	Adapters (located on the back of the server)
PCI two-line WAN		

Table 9. Cables and adapters (continued)









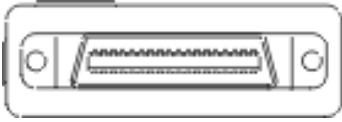
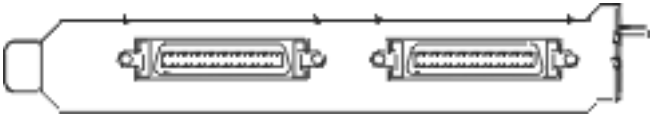
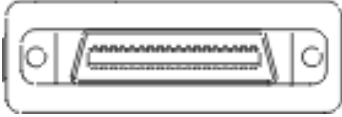

Cables and connectors	Adapter type numbers	Adapters (located on the back of the server)
<p>44H7xxx or 97H73xx</p> 	<p>4745/2745/2742</p>	<p>PCI Two-line WAN Input/Output Adapter</p> 
<p>44H7xxx, 97H73xx, or 44H748x</p>  <p>Integrated modem</p> <p>87G62xx, 21H49xx, or 75G38xx</p> 	<p>2793/2794/2771</p>	<p>PCI Two-line WAN with Modem Input/Output Adapter</p> 
<p>PCI dual WAN</p>		
<p>Integrated modem</p> <p>87G62xx, 21H49xx, or 75G38xx</p> 	<p>2772/2773</p>	<p>PCI Dual WAN with Modem Input/Output Adapter</p> 
<p>PCI twinaxial</p>		
<p>Part number 12F5093</p> 	<p>4746/9746/2746</p>	<p>PCI Twinaxial Workstation Controller Input/Output Adapter</p> 
<p>PCI token-ring</p>		
<p>RJ45 Token-ring</p>  <p>Filter P75G5958 or 75G2865</p>  <p>6339098</p> 	<p>2744/4959</p>	<p>PCI 4/16/100 Mbps Token-Ring Input/Output Adapter</p> 
<p>PCI quad</p>		
	<p>2805/2806</p>	<p>PCI Quad Modem Input/Output Adapter</p> 

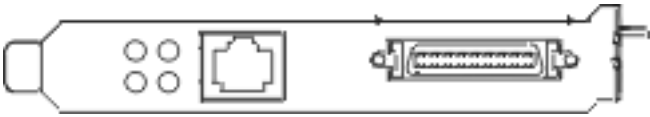
Table 9. Cables and adapters (continued)

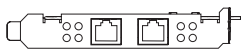
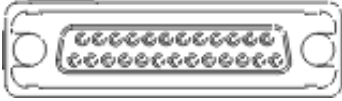
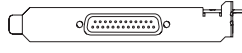









Cables and connectors	Adapter type numbers	Adapters (located on the back of the server)
	6312	PCI Quad Digital Trunk Adapter 
Ethernet		
RJ45 Ethernet 	2838/2849	PCI 100/10 Mbps Ethernet Input/Output Adapter 
	5700	PCI 1 Gbps Ethernet Input/Output Adapter 
	5701	PCI 1 Gbps Ethernet UTP Input/Output Adapter 
	5706	PCI 1 Gbps Ethernet TX Input/Output Adapter 
	5707	PCI 1 Gbps Ethernet SX Input/Output Adapter 
	5718	PCI 10 Gbps Ethernet Input/Output Adapter 
Server cards		
Part number 45H2433 44H8677 connects to cable 45H2433  Video extension cable, 44H8676 	2891/2892	Netfinity Server Card 
	4810/9710	Integrated xSeries server card 
	4821/9712	Integrated xSeries server card
RAID disk unit controllers		
	2757	PCI Ultra RAID Disk Unit Controller
	2780	PCI-X Ultra4 RAID Disk Unit Controller

Table 9. Cables and adapters (continued)

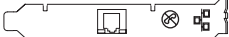
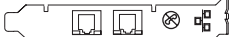
Cables and connectors	Adapter type numbers	Adapters (located on the back of the server)
	5703/4778	PCI-X RAID Disk Unit Controller 
	5709	RAID Enabler Card
Fibre channel disk unit controllers		
	2787	PCI-X Fibre Channel Disk Unit Controller
PCI cryptography		
	4801/4758-023	PCI Cryptographic Coprocessor 
	4805/2058	PCI Cryptographic Accelerator
PCI-X tape unit controllers		
	5704	PCI-X Fibre Channel Tape Unit Controller 
	5702/5712/5715	PCI-X U320 Tape/Disk Unit Controller 
Bus adapters		
	2886	Optical Bus Adapter 
	2887	HSL-2 Bus Adapter 
	6417/28E7	HSL-2/RIO-G Bus Adapter 

2. Connect the other end of the external cables to a network or device.
3. Continue with the next task.

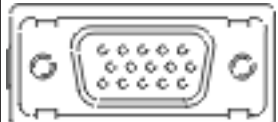
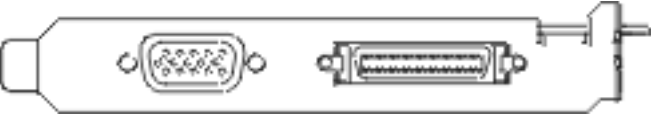
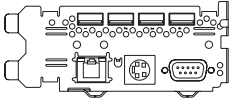
Turning on your server

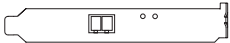
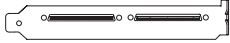
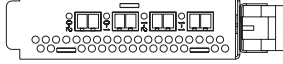
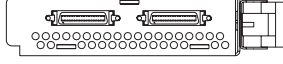
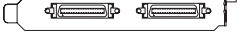
Before you turn on your server, complete these steps.

1. Plug in and turn on your console.
2. Plug in your server or uninterruptible power supply.

Note: If you are using two power cords, plug each power cord into a separate power source.

3. Plug in any attached expansion units.
4. Open the control panel door on the front of the server. The control panel should be lit and display 01 BN V=F. The server is not yet powered on.

Note: If 01 BN V=F is not on the display, you might need to change the mode. If you need these instructions, go to the Accessing control panel functions topic in the information center.

5. Press the white Power On button. There is a short delay until the server starts to turn on. It takes 5 to 20 minutes. 01 BN V=F or A900 2000, which indicates the console is not connected yet, appears on the control panel when the server is powered on.
6. Install the back cover on the server.
You have cabled your server.
7. Continue with the next task.

Note: If you plan to install any Linux specific hardware, or if you plan to create logical partitions on your iSeries, you might need to add or move some hardware, such as network I/O adapters, at this time. If you are unsure as to where to put the new or changed hardware, run the LPAR

Validation Tool (LVT) . You can find information about LPAR in the Logical partitions topic and additional information in the Linux in a logical partition topic of the information center.

Related information

Logical partitions

Linux in a logical partition

Setting up your server

To set up your server, follow these instructions.

If you have a PC connected to the LAN, you can use EZ-Setup on the *iSeries Setup and Operations* CD-ROM to complete your server setup.

If you do not have a PC connected to the LAN, go to Setting Up Your Twinaxial System  to continue with your server setup.

Cabling a model 820 and twinaxial console without an expansion unit

To connect the cables to your server and to the console, follow these instructions.

Print this topic using the Print key.

Attach the 8-port Twinaxial cable to the 2746 connector in position C03, C04, or C11.

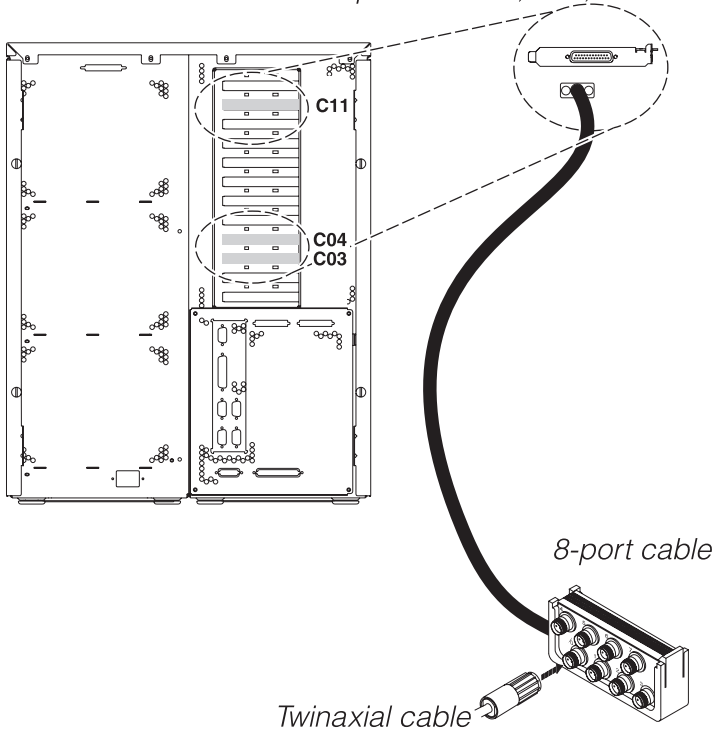

RZAM9700-3

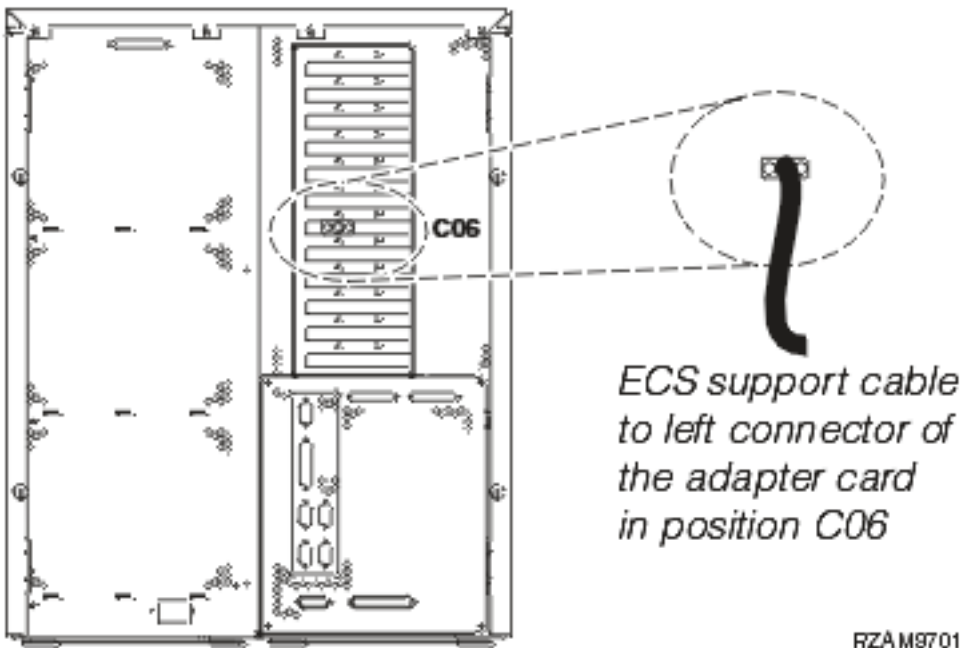

RZAM9701-1

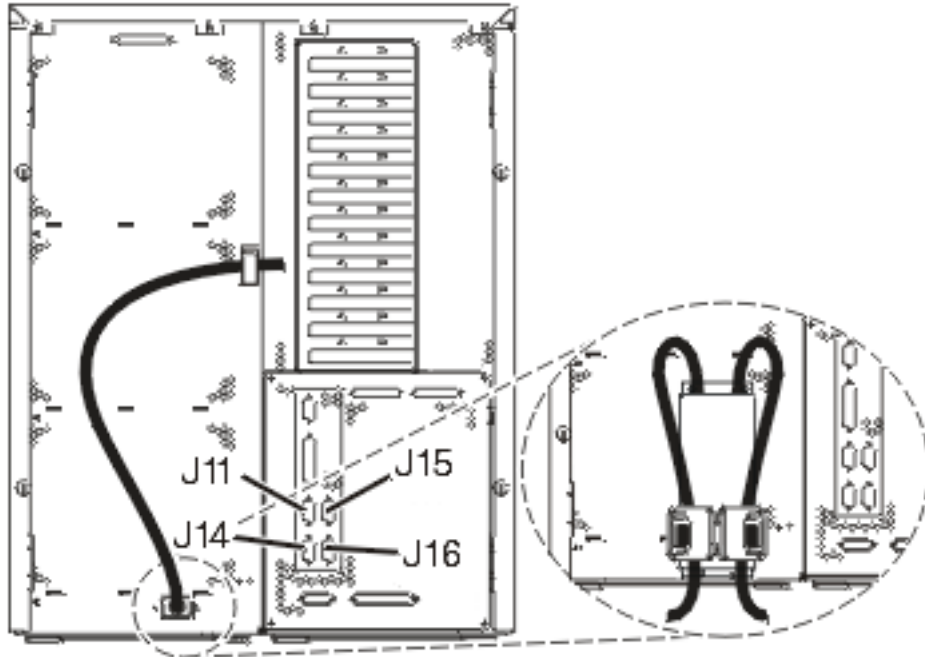

RZA M970 4-1

Connecting the twinaxial cable

To connect the twinaxial cable, follow these instructions.

1. Look at card positions C03, C04, and C11 on the back of the server. Locate the position that contains card 2746. This is your twinaxial adapter card. If more than one position contains card 2746, then select the card in position C04. If card 2746 is not in position C04, but it is in position C03 or C11, select the card in either location.
2. Locate the 8-port twinaxial attachment cable (PN 21F5093). Attach the cable to the connector on the 2746 twinaxial adapter. You must supply this twinaxial cable.
3. Connect a twinaxial cable from the workstation that you are using as the system console to port 0 on the 8-port twinaxial attachment cable.

Note: The workstation address of your console must be set to 0. To set the address, refer to the reference material that was included with your workstation.

4. Continue with the next task.

Connecting the electronic customer support cable

To connect the electronic customer support cable, follow these instructions.

Are you installing electronic customer support?

- **No:** Continue with the next task.
- **Yes:**

1. Connect a telephone cable to the left connector of the adapter located in position C06.
2. Connect the other end of the telephone cable to an analog telephone jack.

Electronic customer support helps automate management of your server and streamline your support. Find out more about electronic customer support by looking at the IBM System i Technical Support

Advantage information included with your server, or go to the Support for IBM System i  Web site. Electronic customer support can be configured using the *iSeries Setup and Operations* CD-ROM that came with your server.

Continue with the next task.

Connecting the power cords

Before you connect the power cords, complete these steps.

If you have a 4758 PCI Cryptographic Coprocessor card to install, go to the instructions that came with the card. This card was shipped in a separate box. Return here after the card is installed.

Note: If you are using two power cords, route them through the retainer clips as shown below after you connect them to the server.

Are you installing an uninterruptible power supply?

- **No:** Connect the server power cords to the server.

Note: Do not plug the power cord into the power outlet. Do not turn on your server.

Continue with the next task.

- **Yes:** Connect the power control cable for the uninterruptible power supply to J14. Do not plug the power cord of the uninterruptible power supply into the power outlet and do not turn on your server. For instructions to complete the installation of the uninterruptible power supply, go to the Web site Powerware UPS Solutions for IBM

(<http://www.oem.powerware.com/ibm-ups/Products/9910Solutions/ina.asp>) .

Continue with the next task.

Connecting external cables

To connect external cables, follow these instructions.

If you do not have any external cables to connect to the adapter cards on the back of your server or expansion unit, continue with the next task.

1. Use this table to connect the cables to the matching adapters on the back of your server. You might need to connect more than one cable.

Note: If the cable did not come with your server, then you need to supply it.

Table 10. Cables and adapters





Cables and connectors	Adapter type numbers	Adapters (located on the back of the server)
PCI two-line WAN		
44H7xxx or 97H73xx 	4745/2745/2742	PCI Two-line WAN Input/Output Adapter 
44H7xxx, 97H73xx, or 44H748x 	2793/2794/2771	PCI Two-line WAN with Modem Input/Output Adapter 
Integrated modem 87G62xx, 21H49xx, or 75G38xx 		
PCI dual WAN		

Table 10. Cables and adapters (continued)



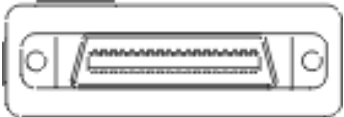
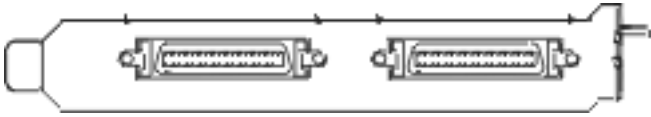

Cables and connectors	Adapter type numbers	Adapters (located on the back of the server)
<p>Integrated modem</p> <p>87G62xx, 21H49xx, or 75G38xx</p> 	<p>2772/2773</p>	<p>PCI Dual WAN with Modem Input/Output Adapter</p> 
PCI twinaxial		
<p>Part number 12F5093</p> 	<p>4746/9746/2746</p>	<p>PCI Twinaxial Workstation Controller Input/Output Adapter</p> 
PCI token-ring		
<p>RJ45 Token-ring</p>  <p>Filter P75G5958 or 75G2865</p>  <p>6339098</p> 	<p>2744/4959</p>	<p>PCI 4/16/100 Mbps Token-Ring Input/Output Adapter</p> 
PCI quad		
	<p>2805/2806</p>	<p>PCI Quad Modem Input/Output Adapter</p> 
	<p>6312</p>	<p>PCI Quad Digital Trunk Adapter</p> 
Ethernet		

Table 10. Cables and adapters (continued)



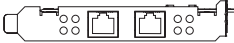
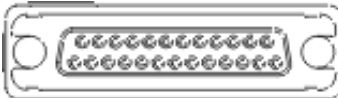
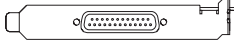

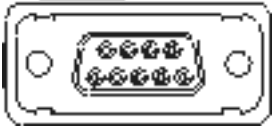
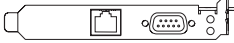

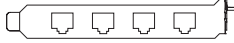

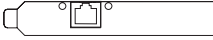
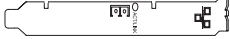

Cables and connectors	Adapter type numbers	Adapters (located on the back of the server)
RJ45 Ethernet 	2838/2849	PCI 100/10 Mbps Ethernet Input/Output Adapter 
	5700	PCI 1 Gbps Ethernet Input/Output Adapter 
	5701	PCI 1 Gbps Ethernet UTP Input/Output Adapter 
	5706	PCI 1 Gbps Ethernet TX Input/Output Adapter 
	5707	PCI 1 Gbps Ethernet SX Input/Output Adapter 
	5718	PCI 10 Gbps Ethernet Input/Output Adapter 
Server cards		
Part number 45H2433 44H8677 connects to cable 45H2433  Video extension cable, 44H8676 	2891/2892	Netfinity Server Card 
	4810/9710	Integrated xSeries server card 
	4821/9712	Integrated xSeries server card
RAID disk unit controllers		
	2757	PCI Ultra RAID Disk Unit Controller
	2780	PCI-X Ultra4 RAID Disk Unit Controller
	5703/4778	PCI-X RAID Disk Unit Controller 
	5709	RAID Enabler Card
Fibre channel disk unit controllers		

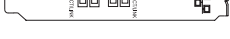
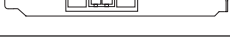
Table 10. Cables and adapters (continued)

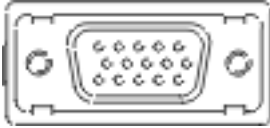
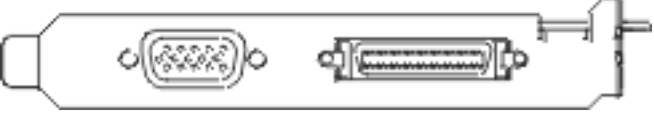
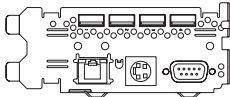
Cables and connectors	Adapter type numbers	Adapters (located on the back of the server)
	2787	PCI-X Fibre Channel Disk Unit Controller 
PCI cryptography		
	4801/4758-023	PCI Cryptographic Coprocessor 
	4805/2058	PCI Cryptographic Accelerator
PCI-X tape unit controllers		
	5704	PCI-X Fibre Channel Tape Unit Controller 
	5702/5712/5715	PCI-X U320 Tape/Disk Unit Controller 
Bus adapters		
	2886	Optical Bus Adapter 
	2887	HSL-2 Bus Adapter 
	6417/28E7	HSL-2/RIO-G Bus Adapter 

2. Connect the other end of the external cables to a network or device.
3. Continue with the next task.

Turning on your server

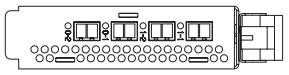
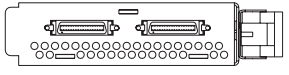
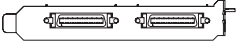
Before you turn on your server, complete these steps.

1. Plug in and turn on your console.
2. Plug in your server or uninterruptible power supply.

Note: If you are using two power cords, plug each power cord into a separate power source.

3. Plug in any attached expansion units.
4. Open the control panel door on the front of the server. The control panel should be lit and display 01 BN V=F. The server is not yet powered on.

Note: If 01 BN V=F is not on the display, you might need to change the mode. If you need these instructions, go to the Accessing control panel functions topic in the information center.

5. Press the white Power On button. There is a short delay until the server starts to turn on. It takes 5 to 20 minutes. 01 BN V=F or A900 2000, which indicates the console is not connected yet, appears on the control panel when the server is powered on.
6. Install the back cover on the server.
You have cabled your server.
7. Continue with the next task.

Note: If you plan to install any Linux specific hardware, or if you plan to create logical partitions on your iSeries, you might need to add or move some hardware, such as network I/O adapters, at this time. If you are unsure as to where to put the new or changed hardware, run the LPAR

Validation Tool (LVT) . You can find information about LPAR in the Logical partitions topic and additional information in the Linux in a logical partition topic of the information center.

Setting up your server

To set up your server, follow these instructions.

If you have a PC connected to the LAN, you can use EZ-Setup on the *iSeries Setup and Operations* CD-ROM to complete your server setup.

If you do not have a PC connected to the LAN, go to Setting Up Your Twinaxial System  to continue with your server setup.

Cabling a model 820 and Operations Console with an expansion unit

To connect the cables to your server and to the console, follow these instructions.

Print this topic using the Print key.

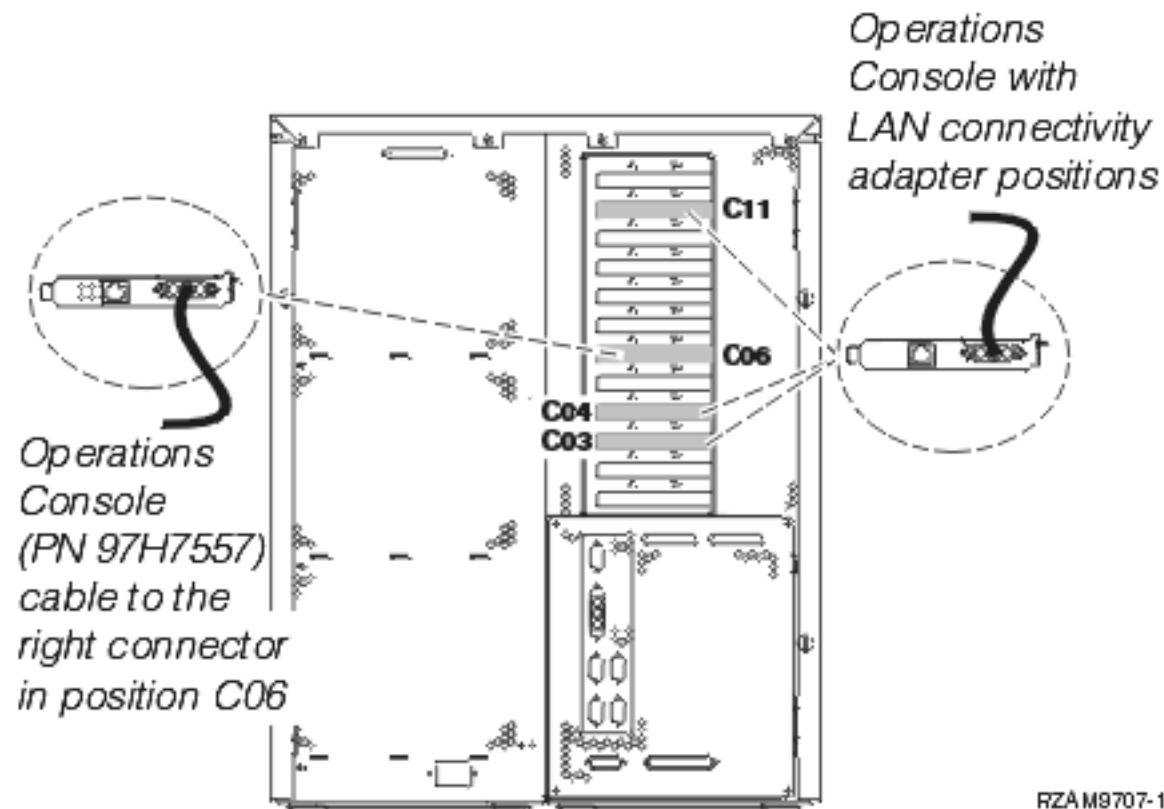

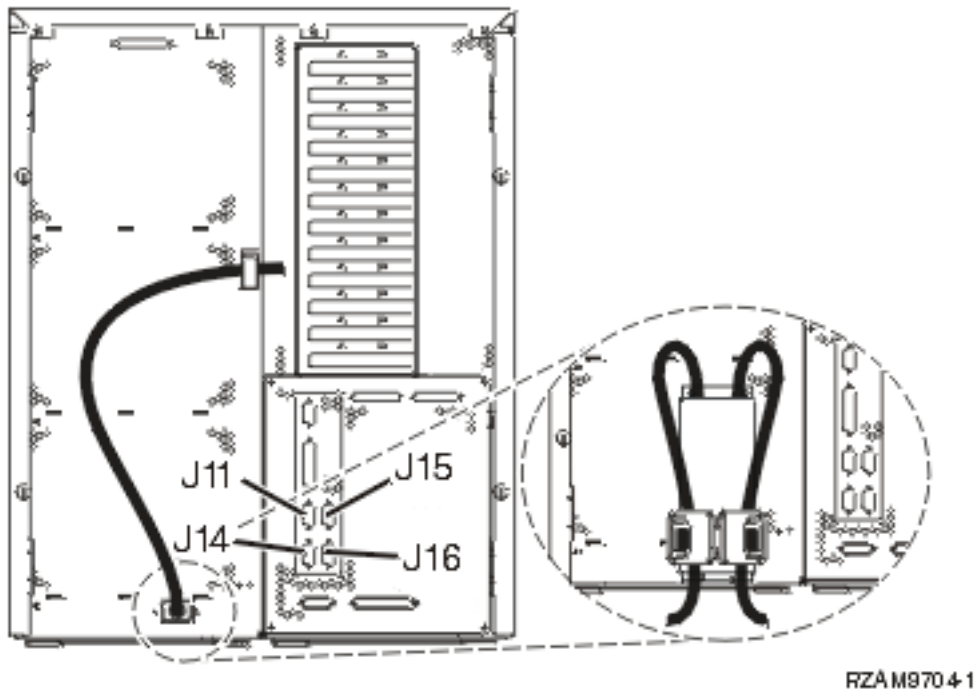
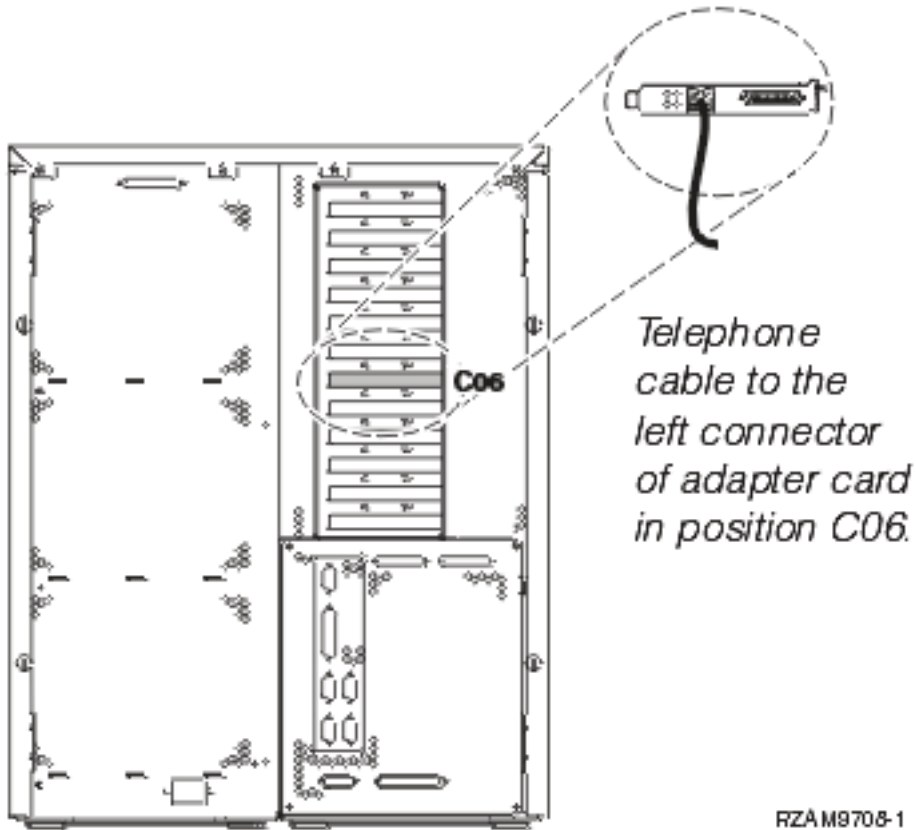

Connecting the Operations Console cable

To connect the Operations Console cable, follow these instructions.

1. Turn off and unplug the PC that is going to serve as the system console.

2. Locate the Operations Console cable (PN 97H7557). Connect the Operations Console cable to the right connector of the 2771 or 2793 adapter located in position C06 on the back of the server. Are you using Operations Console with LAN connectivity?

- **No**

- a. Connect the other end of the Operations Console cable to the first or only communications (serial) port on the back of the PC being used as the console.
- b. Continue with the next task.

- **Yes**

If your primary choice is LAN connectivity, you do not need to connect the Operation Console cables to your PC at this time. If you develop a problem, you can connect these cables to the PC and configure Operations Console. See Operations Console.

- a. Connect a network cable from the adapter in position C04, C03, or C11 to your local network.
- b. Continue with the next task.

Related information

Operations Console

Connecting the electronic customer support cable

To connect the electronic customer support cable, follow these instructions.

Are you installing electronic customer support?

- **No:** Continue with the next task.

- **Yes:**

1. Connect a telephone cable to the left connector of the adapter located in position C06.
2. Connect the other end of the telephone cable to an analog telephone jack.

Electronic customer support helps automate management of your server and streamline your support. Find out more about electronic customer support by looking at the IBM System i Technical Support





Advantage information included with your server, or go to the Support for IBM System i  Web site. Electronic customer support can be configured using the *iSeries Setup and Operations* CD-ROM that came with your server.

Continue with the next task.

Cabling the expansion unit

To cable the expansion unit, follow these instructions.

Note: Do not plug the expansion-unit power cord into the power outlet as directed by the following documents.

- Setting Up Your 0578, 5074, 5078, or 5079 Expansion Unit 
- Setting Up Your 5075 Expansion Unit 
- Setting Up Your 5065 or 5066 Expansion Unit 
- Setting Up Your 0588, 0595, 5088, 5094, 5095 or 5294 Expansion Unit 

After you have set up the expansion unit and replaced the back cover, continue with the next task.

Connecting the power cords

Before you connect the power cords, complete these steps.

If you have a 4758 PCI Cryptographic Coprocessor card to install, go to the instructions that came with the card. This card was shipped in a separate box. Return here after the card is installed.

Note: If you are using two power cords, route them through the retainer clips as shown below after you connect them to the server.

Are you installing an uninterruptible power supply?

- **No:** Connect the server power cords to the server.

Note: Do not plug the power cord into the power outlet. Do not turn on your server.

Continue with the next task.

- **Yes:** Connect the power control cable for the uninterruptible power supply to J14. Do not plug the power cord of the uninterruptible power supply into the power outlet and do not turn on your server. For instructions to complete the installation of the uninterruptible power supply, go to the Web site Powerware UPS Solutions for IBM

(<http://www.oem.powerware.com/ibm-ups/Products/9910Solutions/ina.asp>) .

Continue with the next task.

Connecting external cables

To connect external cables, follow these instructions.

If you do not have any external cables to connect to the adapter cards on the back of your server or expansion unit, continue with the next task.

1. Use this table to connect the cables to the matching adapters on the back of your server. You might need to connect more than one cable.

Note: If the cable did not come with your server, then you need to supply it.

Table 11. Cables and adapters





Cables and connectors	Adapter type numbers	Adapters (located on the back of the server)
PCI two-line WAN		
44H7xxx or 97H73xx 	4745/2745/2742	PCI Two-line WAN Input/Output Adapter 
44H7xxx, 97H73xx, or 44H748x  Integrated modem 87G62xx, 21H49xx, or 75G38xx 	2793/2794/2771	PCI Two-line WAN with Modem Input/Output Adapter 
PCI dual WAN		
Integrated modem 87G62xx, 21H49xx, or 75G38xx 	2772/2773	PCI Dual WAN with Modem Input/Output Adapter 

Table 11. Cables and adapters (continued)



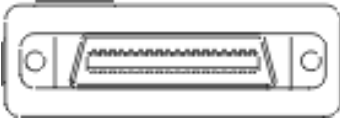
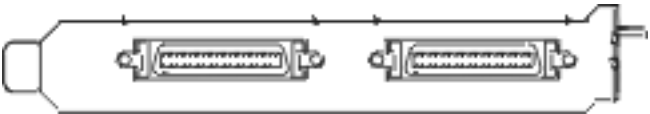
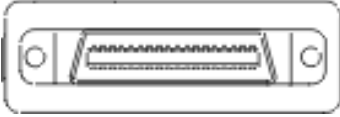



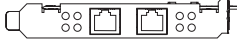



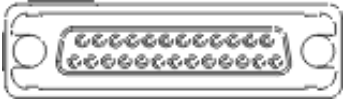

Cables and connectors	Adapter type numbers	Adapters (located on the back of the server)
PCI twinaxial		
Part number 12F5093 	4746/9746/2746	PCI Twinaxial Workstation Controller Input/Output Adapter 
PCI token-ring		
RJ45 Token-ring  Filter P75G5958 or 75G2865  6339098 	2744/4959	PCI 4/16/100 Mbps Token-Ring Input/Output Adapter 
PCI quad		
	2805/2806	PCI Quad Modem Input/Output Adapter 
	6312	PCI Quad Digital Trunk Adapter 
Ethernet		
RJ45 Ethernet 	2838/2849	PCI 100/10 Mbps Ethernet Input/Output Adapter 
	5700	PCI 1 Gbps Ethernet Input/Output Adapter 
	5701	PCI 1 Gbps Ethernet UTP Input/Output Adapter 
	5706	PCI 1 Gbps Ethernet TX Input/Output Adapter 
	5707	PCI 1 Gbps Ethernet SX Input/Output Adapter 
	5718	PCI 10 Gbps Ethernet Input/Output Adapter 

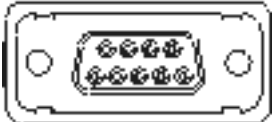
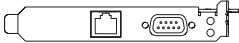
Table 11. Cables and adapters (continued)



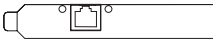

Cables and connectors	Adapter type numbers	Adapters (located on the back of the server)
Server cards		
Part number 45H2433 44H8677 connects to cable 45H2433  Video extension cable, 44H8676 	2891/2892	Netfinity Server Card 
	4810/9710	Integrated xSeries server card 
	4821/9712	Integrated xSeries server card
RAID disk unit controllers		
	2757	PCI Ultra RAID Disk Unit Controller
	2780	PCI-X Ultra4 RAID Disk Unit Controller
	5703/4778	PCI-X RAID Disk Unit Controller 
	5709	RAID Enabler Card
Fibre channel disk unit controllers		
	2787	PCI-X Fibre Channel Disk Unit Controller
PCI cryptography		
	4801/4758-023	PCI Cryptographic Coprocessor 
	4805/2058	PCI Cryptographic Accelerator
PCI-X tape unit controllers		
	5704	PCI-X Fibre Channel Tape Unit Controller 
	5702/5712/5715	PCI-X U320 Tape/Disk Unit Controller 
Bus adapters		

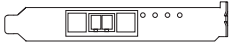
Table 11. Cables and adapters (continued)

Cables and connectors	Adapter type numbers	Adapters (located on the back of the server)
	2886	Optical Bus Adapter 
	2887	HSL-2 Bus Adapter 
	6417/28E7	HSL-2/RIO-G Bus Adapter 

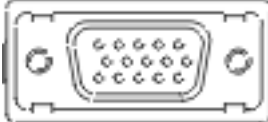
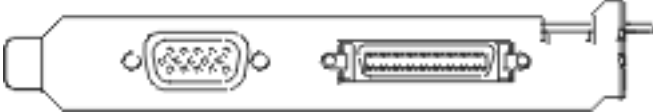
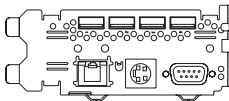
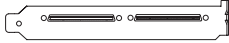
2. Connect the other end of the external cables to a network or device.
3. Continue with the next task.

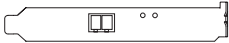
Turning on your server

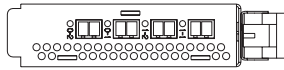
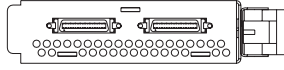
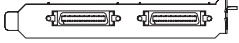
Before you turn on your server, complete these steps.

1. Plug in and turn on your console.
2. Plug in your server or uninterruptible power supply.

Note: If you are using two power cords, plug each power cord into a separate power source.

3. Plug in any attached expansion units.
4. Open the control panel door on the front of the server. The control panel should be lit and display 01 BN V=F. The server is not yet powered on.

Note: If 01 BN V=F is not on the display, you might need to change the mode. If you need these instructions, go to the Accessing control panel functions topic in the information center.

5. Press the white Power On button. There is a short delay until the server starts to turn on. It takes 5 to 20 minutes. 01 BN V=F or A900 2000, which indicates the console is not connected yet, appears on the control panel when the server is powered on.
6. Install the back cover on the server.
You have cabled your server.
7. Continue with the next task.

Note: If you plan to install any Linux specific hardware, or if you plan to create logical partitions on your iSeries, you might need to add or move some hardware, such as network I/O adapters, at this time. If you are unsure as to where to put the new or changed hardware, run the LPAR

Validation Tool (LVT) . You can find information about LPAR in the Logical partitions topic and additional information in the Linux in a logical partition topic of the information center.

Setting up your server

To continue to set up your server, return to EZ-Setup on the *iSeries Setup and Operations* CD-ROM.

Cabling a model 820 and Operations Console without an expansion unit

To connect the cables to your server and to the console, follow these instructions.

Print this topic using the Print key.

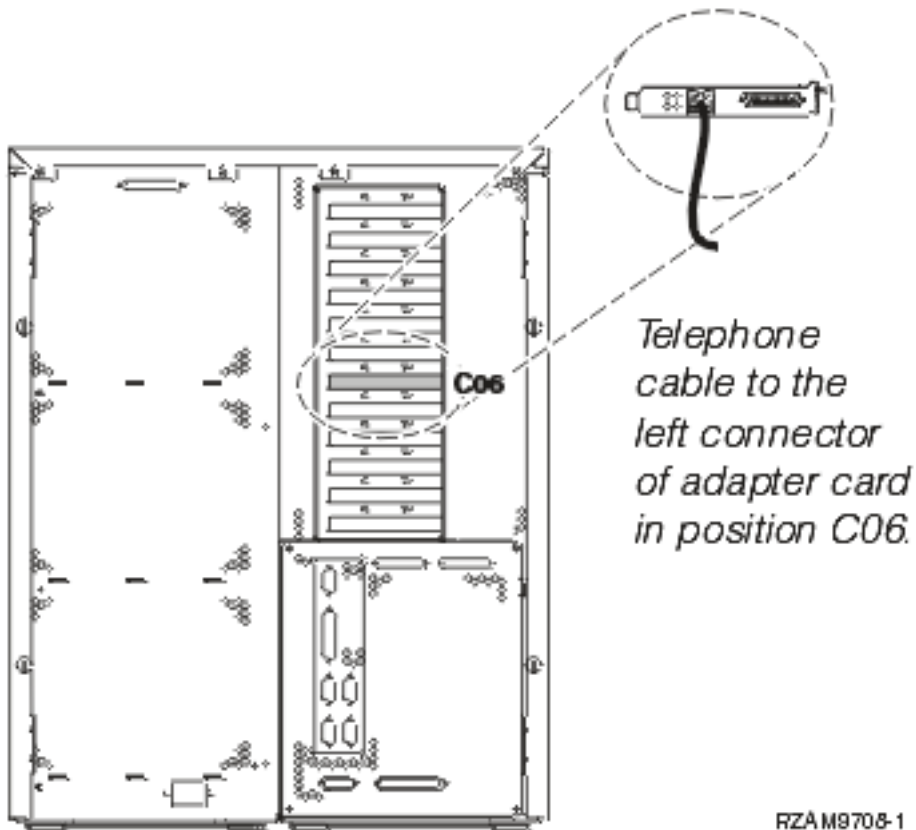
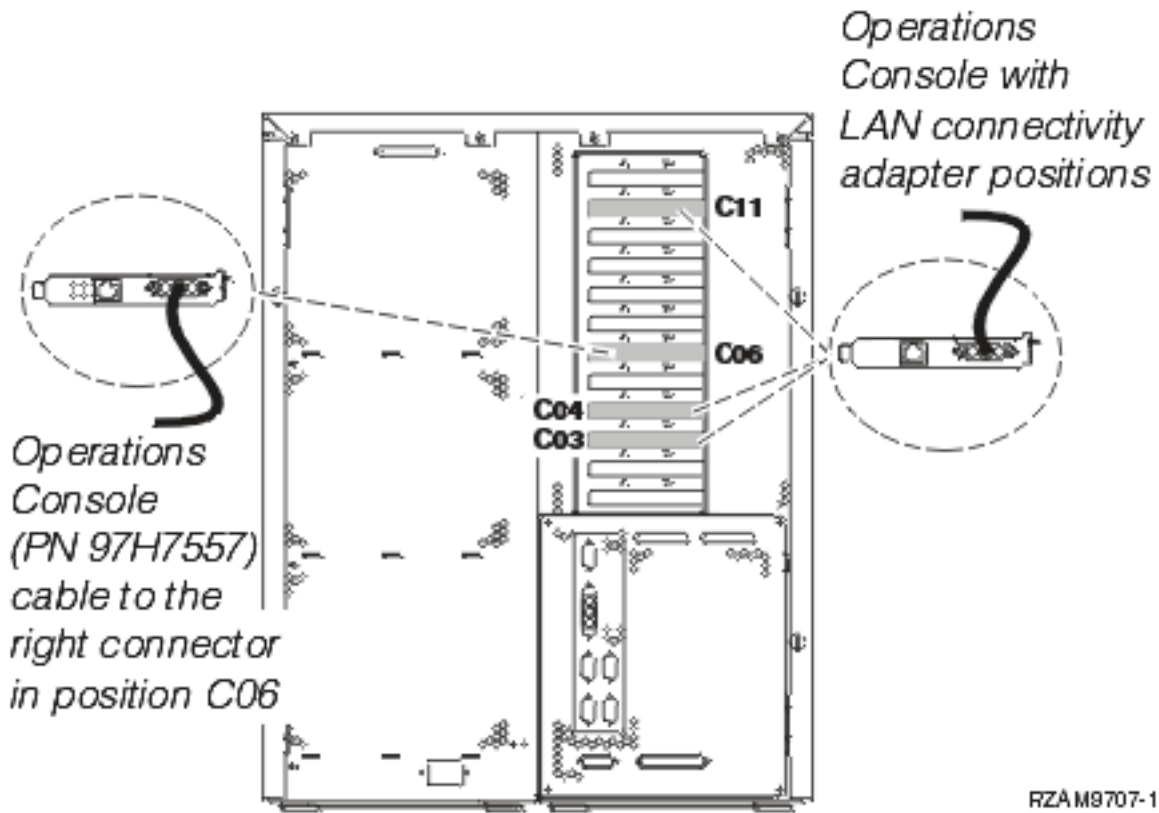

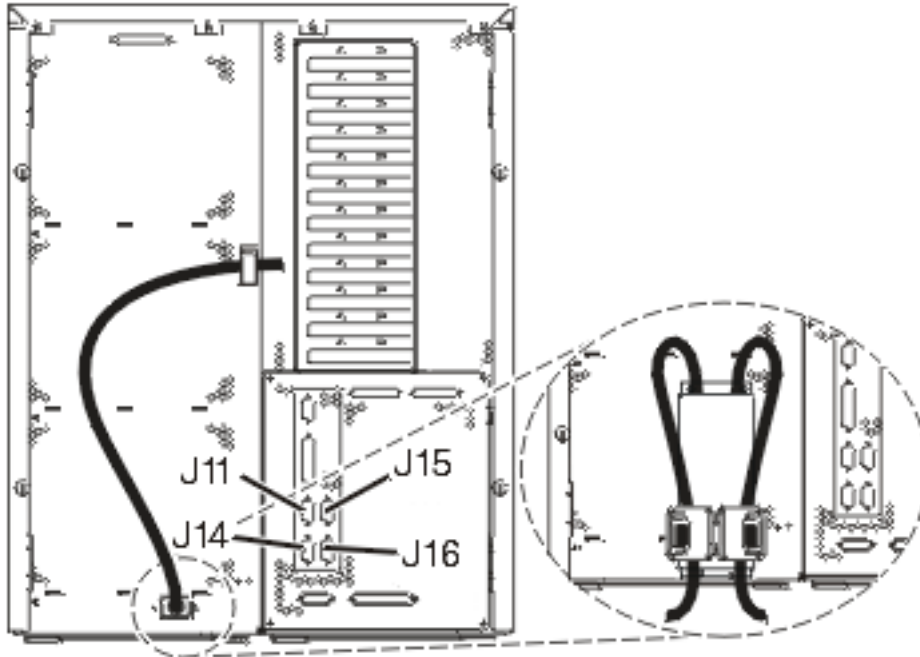

RZA M970 4-1

Connecting the Operations Console cable

To connect the Operations Console cable, follow these instructions.

1. Turn off and unplug the PC that is going to serve as the system console.
2. Locate the Operations Console cable (PN 97H7557). Connect the Operations Console cable to the right connector of the 2771 or 2793 adapter located in position C06 on the back of the server. Are you using Operations Console with LAN connectivity?

- **No**

- a. Connect the other end of the Operations Console cable to the first or only communications (serial) port on the back of the PC being used as the console.
- b. Continue with the next task.

- **Yes**

If your primary choice is LAN connectivity, you do not need to connect the Operation Console cables to your PC at this time. If you develop a problem, you can connect these cables to the PC and configure Operations Console. See Operations Console.

- a. Connect a network cable from the adapter in position C04, C03, or C11 to your local network.
- b. Continue with the next task.

Connecting the electronic customer support cable

To connect the electronic customer support cable, follow these instructions.

Are you installing electronic customer support?

- **No:** Continue with the next task.

- **Yes:**

1. Connect a telephone cable to the left connector of the adapter located in position C06.
2. Connect the other end of the telephone cable to an analog telephone jack.

Electronic customer support helps automate management of your server and streamline your support. Find out more about electronic customer support by looking at the IBM System i Technical Support

Advantage information included with your server, or go to the Support for IBM System i  Web site. Electronic customer support can be configured using the *iSeries Setup and Operations* CD-ROM that came with your server.

Continue with the next task.

Connecting the power cords

Before you connect the power cords, complete these steps.

If you have a 4758 PCI Cryptographic Coprocessor card to install, go to the instructions that came with the card. This card was shipped in a separate box. Return here after the card is installed.

Note: If you are using two power cords, route them through the retainer clips as shown below after you connect them to the server.

Are you installing an uninterruptible power supply?

- **No:** Connect the server power cords to the server.

Note: Do not plug the power cord into the power outlet. Do not turn on your server.

Continue with the next task.

- **Yes:** Connect the power control cable for the uninterruptible power supply to J14. Do not plug the power cord of the uninterruptible power supply into the power outlet and do not turn on your server. For instructions to complete the installation of the uninterruptible power supply, go to the Web site Powerware UPS Solutions for IBM

(<http://www.oem.powerware.com/ibm-ups/Products/9910Solutions/ina.asp>) .

Continue with the next task.

Connecting external cables

To connect external cables, follow these instructions.

If you do not have any external cables to connect to the adapter cards on the back of your server or expansion unit, continue with the next task.

1. Use this table to connect the cables to the matching adapters on the back of your server. You might need to connect more than one cable.

Note: If the cable did not come with your server, then you need to supply it.

Table 12. Cables and adapters

Cables and connectors	Adapter type numbers	Adapters (located on the back of the server)
PCI two-line WAN		
44H7xxx or 97H73xx 	4745/2745/2742	PCI Two-line WAN Input/Output Adapter 

Table 12. Cables and adapters (continued)







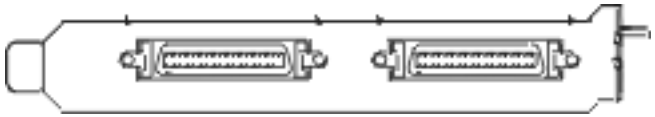



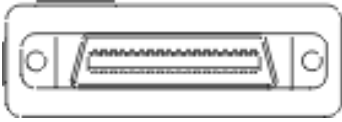

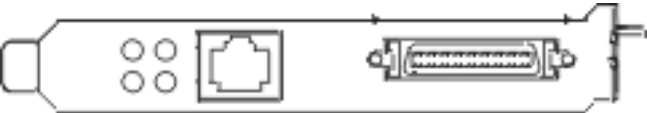
Cables and connectors	Adapter type numbers	Adapters (located on the back of the server)
<p>44H7xx, 97H73xx, or 44H748x</p>  <p>Integrated modem</p> <p>87G62xx, 21H49xx, or 75G38xx</p> 	<p>2793/2794/2771</p>	<p>PCI Two-line WAN with Modem Input/Output Adapter</p> 
PCI dual WAN		
<p>Integrated modem</p> <p>87G62xx, 21H49xx, or 75G38xx</p> 	<p>2772/2773</p>	<p>PCI Dual WAN with Modem Input/Output Adapter</p> 
PCI twinaxial		
<p>Part number 12F5093</p> 	<p>4746/9746/2746</p>	<p>PCI Twinaxial Workstation Controller Input/Output Adapter</p> 
PCI token-ring		
<p>RJ45 Token-ring</p>  <p>Filter P75G5958 or 75G2865</p>  <p>6339098</p> 	<p>2744/4959</p>	<p>PCI 4/16/100 Mbps Token-Ring Input/Output Adapter</p> 
PCI quad		
	<p>2805/2806</p>	<p>PCI Quad Modem Input/Output Adapter</p> 
	<p>6312</p>	<p>PCI Quad Digital Trunk Adapter</p> 
Ethernet		

Table 12. Cables and adapters (continued)











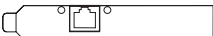
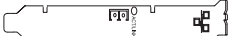

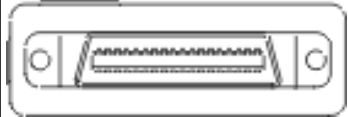
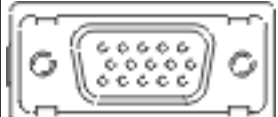

Cables and connectors	Adapter type numbers	Adapters (located on the back of the server)
RJ45 Ethernet 	2838/2849	PCI 100/10 Mbps Ethernet Input/Output Adapter 
	5700	PCI 1 Gbps Ethernet Input/Output Adapter 
	5701	PCI 1 Gbps Ethernet UTP Input/Output Adapter 
	5706	PCI 1 Gbps Ethernet TX Input/Output Adapter 
	5707	PCI 1 Gbps Ethernet SX Input/Output Adapter 
	5718	PCI 10 Gbps Ethernet Input/Output Adapter 
Server cards		
Part number 45H2433 44H8677 connects to cable 45H2433  Video extension cable, 44H8676 	2891/2892	Netfinity Server Card 
	4810/9710	Integrated xSeries server card 
	4821/9712	Integrated xSeries server card 
RAID disk unit controllers		
	2757	PCI Ultra RAID Disk Unit Controller 
	2780	PCI-X Ultra4 RAID Disk Unit Controller 
	5703/4778	PCI-X RAID Disk Unit Controller 
	5709	RAID Enabler Card 
Fibre channel disk unit controllers		

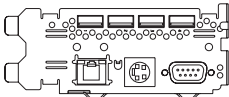
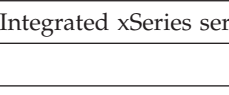
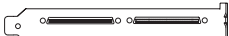
Table 12. Cables and adapters (continued)

Cables and connectors	Adapter type numbers	Adapters (located on the back of the server)
	2787	PCI-X Fibre Channel Disk Unit Controller 
PCI cryptography		
	4801/4758-023	PCI Cryptographic Coprocessor 
	4805/2058	PCI Cryptographic Accelerator
PCI-X tape unit controllers		
	5704	PCI-X Fibre Channel Tape Unit Controller 
	5702/5712/5715	PCI-X U320 Tape/Disk Unit Controller 
Bus adapters		
	2886	Optical Bus Adapter 
	2887	HSL-2 Bus Adapter 
	6417/28E7	HSL-2/RIO-G Bus Adapter 

2. Connect the other end of the external cables to a network or device.
3. Continue with the next task.

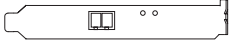
Turning on your server

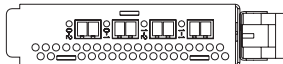
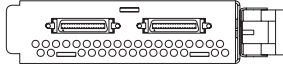
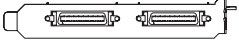
Before you turn on your server, complete these steps.

1. Plug in and turn on your console.
2. Plug in your server or uninterruptible power supply.

Note: If you are using two power cords, plug each power cord into a separate power source.

3. Plug in any attached expansion units.
4. Open the control panel door on the front of the server. The control panel should be lit and display 01 BN V=F. The server is not yet powered on.

Note: If 01 BN V=F is not on the display, you might need to change the mode. If you need these instructions, go to the Accessing control panel functions topic in the information center.

5. Press the white Power On button. There is a short delay until the server starts to turn on. It takes 5 to 20 minutes. 01 BN V=F or A900 2000, which indicates the console is not connected yet, appears on the control panel when the server is powered on.
6. Install the back cover on the server.
You have cabled your server.
7. Continue with the next task.

Note: If you plan to install any Linux specific hardware, or if you plan to create logical partitions on your iSeries, you might need to add or move some hardware, such as network I/O adapters, at this time. If you are unsure as to where to put the new or changed hardware, run the LPAR

Validation Tool (LVT)  . You can find information about LPAR in the Logical partitions topic and additional information in the Linux in a logical partition topic of the information center.

Setting up your server

To continue to set up your server, return to EZ-Setup on the *iSeries Setup and Operations* CD-ROM.

Selecting the model 825 cabling instructions

Before you connect cables to your server, select the cabling instructions that best match the server you are setting up.

Cabling a model 825 and twinaxial console with an expansion unit

To connect the cables to your server and to the console, follow these instructions.

Print this topic using the Print key.

Note: If you are installing your server in a rack, see the Installing System i features topic.

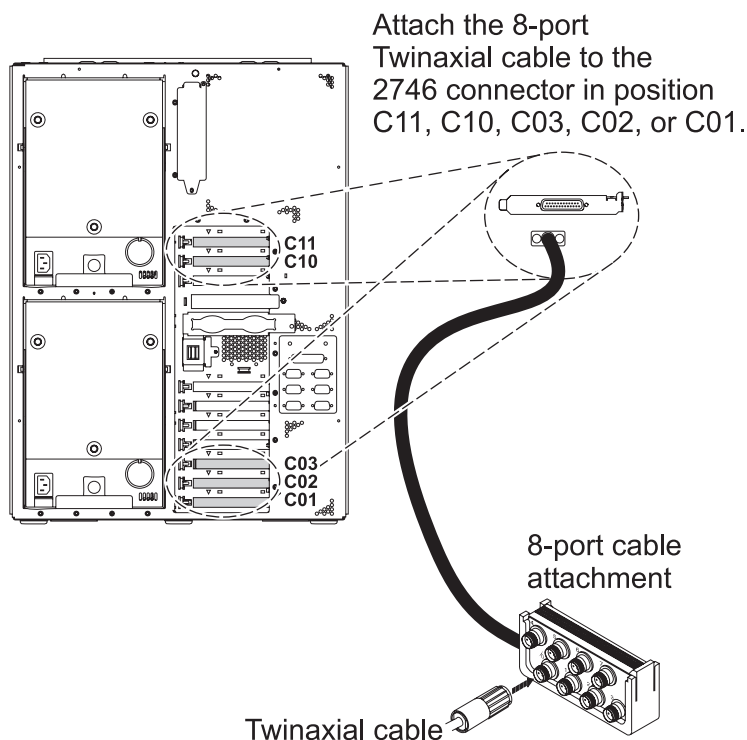

RZAM9900-4

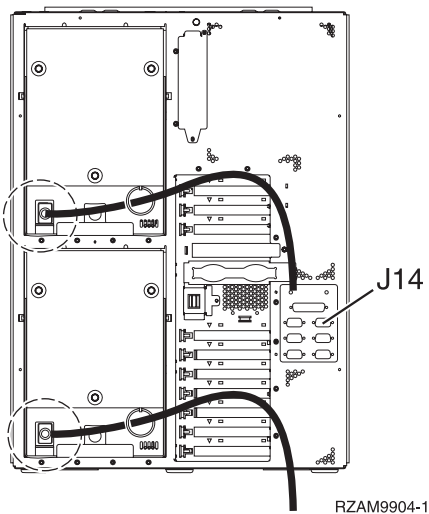
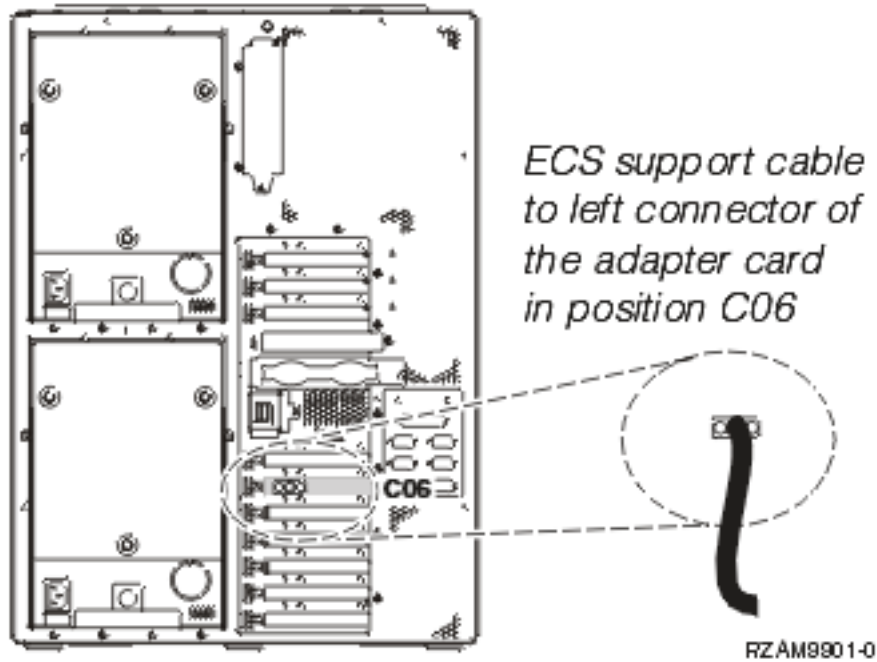

Connecting the twinaxial cable

To connect the twinaxial cable, follow these instructions.

1. Look at card positions C11, C10, C03, C02, and C01 on the back of the server. Locate the position that contains card 2746. This is your twinaxial adapter. If more than one position contains card 2746, then select the first card found in this order: position C11, C10, C03, C02, or C01.
2. Locate the 8-port twinaxial attachment cable (PN 21F5093). Attach the cable to the connector on the 2746 twinaxial adapter. You must supply this twinaxial cable.
3. Connect a twinaxial cable from the workstation that you are using as the system console to port 0 on the 8-port twinaxial attachment cable.

Note: The workstation address of your console must be set to 0. To set the address, refer to the reference material that was included with your workstation.

4. Continue with the next task.

Connecting the electronic customer support cable

To connect the electronic customer support cable, follow these instructions.





Are you installing electronic customer support?

- **No:** Continue with the next task.
- **Yes:**
 1. Connect a telephone cable to the left connector of the adapter located in position C06.
 2. Connect the other end of the telephone cable to an analog telephone jack.Electronic customer support helps automate management of your server and streamline your support. Find out more about electronic customer support by looking at the IBM System i Technical Support Advantage information included with your server, or go to the Support for IBM System i  Web site. Electronic customer support can be configured using the *iSeries Setup and Operations* CD-ROM that came with your server.
Continue with the next task.

Cabling the expansion unit

To cable the expansion unit, follow these instructions.

Note: Do not plug the expansion-unit power cord into the power outlet as directed by the following documents.

- Setting Up Your 0578, 5074, 5078, or 5079 Expansion Unit 
- Setting Up Your 5075 Expansion Unit 
- Setting Up Your 5065 or 5066 Expansion Unit 
- Setting Up Your 0588, 0595, 5088, 5094, 5095 or 5294 Expansion Unit 

After you have set up the expansion unit, continue with the next task.

Connecting the power cords

To connect the power cords, follow these instructions.

If you have a 4758 PCI Cryptographic Coprocessor card to install, go to the instructions that came with the card. This card was shipped in a separate box. Return here after the card is installed.

Note: If you are using two power cords, route them through the retainer ring as shown below after you connect them to the server.

Are you installing an uninterruptible power supply?

- **No:** Connect the server power cords to the server.

Note: Do not plug the power cord into the power outlet. Do not turn on your server.

Continue with the next task.

- **Yes:** Connect the power control cable for the uninterruptible power supply to J14. Do not plug the power cord of the uninterruptible power supply into the outlet and do not turn on your server. For instructions to complete the installation of the uninterruptible power supply, go to the Web site Powerware UPS Solutions for IBM

(<http://www.oem.powerware.com/ibm-ups/Products/9910Solutions/ina.asp>) .

Continue with the next task.

Connecting external cables

To connect external cables, follow these instructions.

If you do not have any external cables to connect to the adapter cards on the back of your server or expansion unit, continue with the next task.

1. Use this table to connect the cables to the matching adapters on the back of your server. You might need to connect more than one cable.

Note: If the cable did not come with your server, then you need to supply it.

Table 13. Cables and adapters







Cables and connectors	Adapter type numbers	Adapters (located on the back of the server)
PCI two-line WAN		
44H7xxx or 97H73xx 	4745/2745/2742	PCI Two-line WAN Input/Output Adapter 
44H7xxx, 97H73xx, or 44H748x  Integrated modem 87G62xx, 21H49xx, or 75G38xx 	2793/2794/2771	PCI Two-line WAN with Modem Input/Output Adapter 
PCI dual WAN		
Integrated modem 87G62xx, 21H49xx, or 75G38xx 	2772/2773	PCI Dual WAN with Modem Input/Output Adapter 
PCI twinaxial		
Part number 12F5093 	4746/9746/2746	PCI Twinaxial Workstation Controller Input/Output Adapter 
PCI token-ring		

Table 13. Cables and adapters (continued)

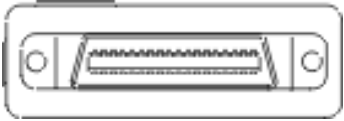
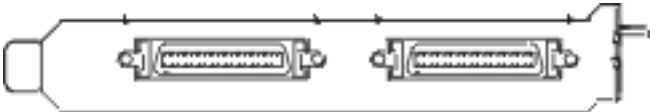

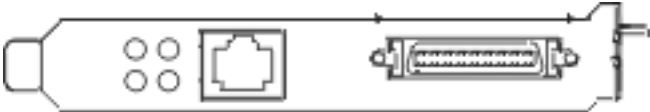

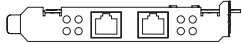
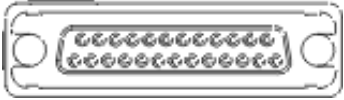



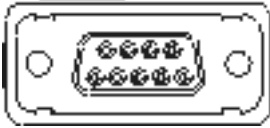

Cables and connectors	Adapter type numbers	Adapters (located on the back of the server)
<p>RJ45 Token-ring</p>  <p>Filter P75G5958 or 75G2865</p>  <p>6339098</p> 	2744/4959	<p>PCI 4/16/100 Mbps Token-Ring Input/Output Adapter</p> 
PCI quad		
	2805/2806	<p>PCI Quad Modem Input/Output Adapter</p> 
	6312	<p>PCI Quad Digital Trunk Adapter</p> 
Ethernet		
<p>RJ45 Ethernet</p> 	2838/2849	<p>PCI 100/10 Mbps Ethernet Input/Output Adapter</p> 
	5700	<p>PCI 1 Gbps Ethernet Input/Output Adapter</p> 
	5701	<p>PCI 1 Gbps Ethernet UTP Input/Output Adapter</p> 
	5706	<p>PCI 1 Gbps Ethernet TX Input/Output Adapter</p> 
	5707	<p>PCI 1 Gbps Ethernet SX Input/Output Adapter</p> 
	5718	<p>PCI 10 Gbps Ethernet Input/Output Adapter</p> 
Server cards		

Table 13. Cables and adapters (continued)

Cables and connectors	Adapter type numbers	Adapters (located on the back of the server)
<p>Part number 45H2433</p> <p>44H8677 connects to cable 45H2433</p>  <p>Video extension cable, 44H8676</p> 	2891/2892	<p>Netfinity Server Card</p> 
	4810/9710	Integrated xSeries server card
	4821/9712	Integrated xSeries server card
RAID disk unit controllers		
	2757	PCI Ultra RAID Disk Unit Controller
	2780	PCI-X Ultra4 RAID Disk Unit Controller
	5703/4778	PCI-X RAID Disk Unit Controller
	5709	RAID Enabler Card
Fibre channel disk unit controllers		
	2787	PCI-X Fibre Channel Disk Unit Controller
PCI cryptography		
	4801/4758-023	PCI Cryptographic Coprocessor
	4805/2058	PCI Cryptographic Accelerator
PCI-X tape unit controllers		
	5704	PCI-X Fibre Channel Tape Unit Controller
	5702/5712/5715	PCI-X U320 Tape/Disk Unit Controller
Bus adapters		
	2886	Optical Bus Adapter

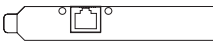
Table 13. Cables and adapters (continued)

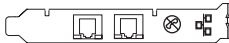
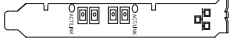
Cables and connectors	Adapter type numbers	Adapters (located on the back of the server)
	2887	HSL-2 Bus Adapter 
	6417/28E7	HSL-2/RIO-G Bus Adapter 

2. Connect the other end of the external cables to a network or device.
3. Continue with the next task.

Turning on your server

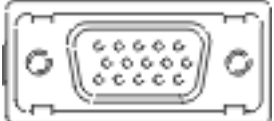
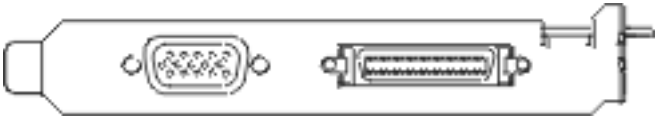
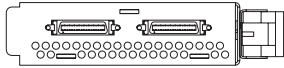
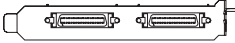
Before you turn on your server, complete these steps.

1. Plug in and turn on your console.
2. Plug in your server or uninterruptible power supply.

Note: If you are using two power cords, plug each power cord into a separate power source.

3. Plug in any attached expansion units.
4. Open the control panel on the front of the server. The control panel should be lit and display 01 BN V=F. The server is not yet powered on.

Note: If 01 BN V=F is not on the display, you might need to change the mode. If you need these instructions, go to the Accessing control panel functions topic in the information center.

5. Press the white Power On button. There is a short delay until the server starts to turn on. It takes 5 to 20 minutes. 01 BN V=F or A900 2000, which indicates the console is not connected yet, appears on the control panel when the server is powered on.
6. Install the back cover on the server, if you have previously removed it.
You have cabled your server.
7. Continue with the next task.

Note: If you plan to install any Linux specific hardware, or if you plan to create logical partitions on your iSeries, you might need to add or move some hardware, such as network I/O adapters, at this time. If you are unsure as to where to put the new or changed hardware, run the LPAR

Validation Tool (LVT) . You can find information about LPAR in the Logical partitions topic and additional information in the Linux in a logical partition topic of the information center.

Related information

- Accessing control panel functions
- Logical partitions
- Linux in a logical partition

Setting up your server

To set up your server, follow these instructions.

If you have a PC connected to the LAN, you can use EZ-Setup on the *iSeries Setup and Operations* CD-ROM to complete your server setup.

If you do not have a PC connected to the LAN, go to Setting Up Your Twinaxial System  to continue with your server setup.

Cabling a model 825 and twinaxial console without an expansion unit

To connect the cables to your server and to the console, follow these instructions.

Print this topic using the Print key.

Note: If you are installing your server in a rack, see the Installing System i features topic.

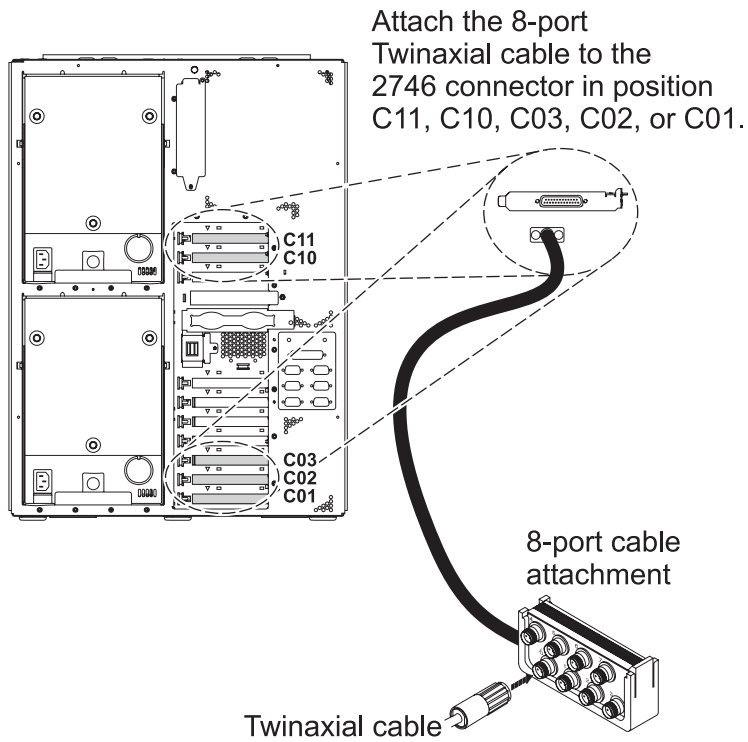

RZAM9900-4

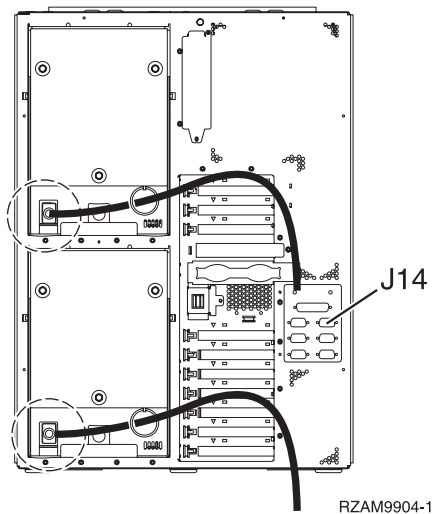
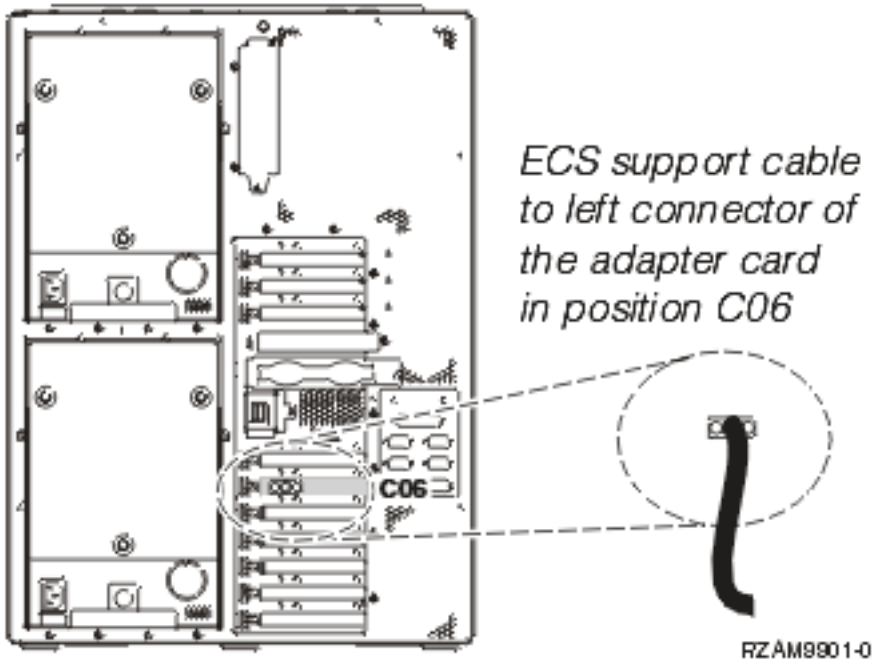

Connecting the twinaxial cable

To connect the twinaxial cable, follow these instructions.

1. Look at card positions C11, C10, C03, C02, and C01 on the back of the server. Locate the position that contains card 2746. This is your twinaxial adapter. If more than one position contains card 2746, then select the first card found in this order: position C11, C10, C03, C02, or C01.
2. Locate the 8-port twinaxial attachment cable (PN 21F5093). Attach the cable to the connector on the 2746 twinaxial adapter. You must supply this twinaxial cable.
3. Connect a twinaxial cable from the workstation that you are using as the system console to port 0 on the 8-port twinaxial attachment cable.

Note: The workstation address of your console must be set to 0. To set the address, refer to the reference material that was included with your workstation.

4. Continue with the next task.

Connecting the electronic customer support cable

To connect the electronic customer support cable, follow these instructions.

Are you installing electronic customer support?

- **No:** Continue with the next task.
- **Yes:**
 1. Connect a telephone cable to the left connector of the adapter located in position C06.
 2. Connect the other end of the telephone cable to an analog telephone jack.Electronic customer support helps automate management of your server and streamline your support. Find out more about electronic customer support by looking at the IBM System i Technical Support Advantage information included with your server, or go to the Support for IBM System i  Web site. Electronic customer support can be configured using the *iSeries Setup and Operations* CD-ROM that came with your server.
Continue with the next task.

Connecting the power cords

To connect the power cords, follow these instructions.

If you have a 4758 PCI Cryptographic Coprocessor card to install, go to the instructions that came with the card. This card was shipped in a separate box. Return here after the card is installed.

Note: If you are using two power cords, route them through the retainer ring as shown below after you connect them to the server.

Are you installing an uninterruptible power supply?

- **No:** Connect the server power cords to the server.

Note: Do not plug the power cord into the power outlet. Do not turn on your server.
Continue with the next task.
- **Yes:** Connect the power control cable for the uninterruptible power supply to J14. Do not plug the power cord of the uninterruptible power supply into the outlet and do not turn on your server. For instructions to complete the installation of the uninterruptible power supply, go to the Web site Powerware UPS Solutions for IBM
(<http://www.oem.powerware.com/ibm-ups/Products/9910Solutions/ina.asp>)  .
Continue with the next task.

Connecting external cables

To connect external cables, follow these instructions.

If you do not have any external cables to connect to the adapter cards on the back of your server or expansion unit, continue with the next task.

1. Use this table to connect the cables to the matching adapters on the back of your server. You might need to connect more than one cable.

Note: If the cable did not come with your server, then you need to supply it.

Table 14. Cables and adapters

Cables and connectors	Adapter type numbers	Adapters (located on the back of the server)
PCI two-line WAN		

Table 14. Cables and adapters (continued)









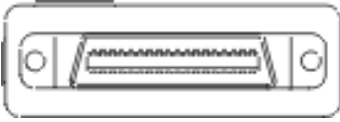
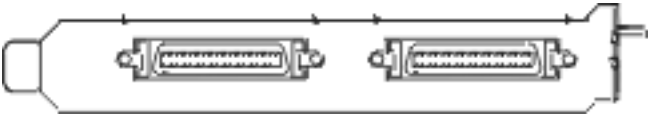
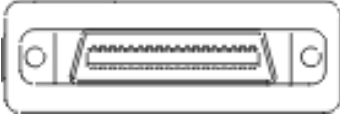

Cables and connectors	Adapter type numbers	Adapters (located on the back of the server)
<p>44H7xxx or 97H73xx</p> 	<p>4745/2745/2742</p>	<p>PCI Two-line WAN Input/Output Adapter</p> 
<p>44H7xxx, 97H73xx, or 44H748x</p>  <p>Integrated modem</p> <p>87G62xx, 21H49xx, or 75G38xx</p> 	<p>2793/2794/2771</p>	<p>PCI Two-line WAN with Modem Input/Output Adapter</p> 
<p>PCI dual WAN</p>		
<p>Integrated modem</p> <p>87G62xx, 21H49xx, or 75G38xx</p> 	<p>2772/2773</p>	<p>PCI Dual WAN with Modem Input/Output Adapter</p> 
<p>PCI twinaxial</p>		
<p>Part number 12F5093</p> 	<p>4746/9746/2746</p>	<p>PCI Twinaxial Workstation Controller Input/Output Adapter</p> 
<p>PCI token-ring</p>		
<p>RJ45 Token-ring</p>  <p>Filter P75G5958 or 75G2865</p>  <p>6339098</p> 	<p>2744/4959</p>	<p>PCI 4/16/100 Mbps Token-Ring Input/Output Adapter</p> 
<p>PCI quad</p>		
	<p>2805/2806</p>	<p>PCI Quad Modem Input/Output Adapter</p> 

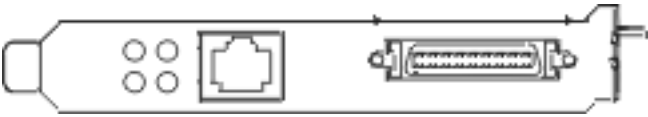
Table 14. Cables and adapters (continued)

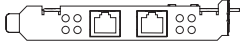
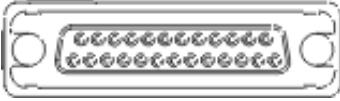
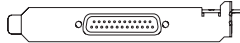









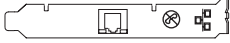
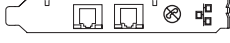

Cables and connectors	Adapter type numbers	Adapters (located on the back of the server)
	6312	PCI Quad Digital Trunk Adapter 
Ethernet		
RJ45 Ethernet 	2838/2849	PCI 100/10 Mbps Ethernet Input/Output Adapter 
	5700	PCI 1 Gbps Ethernet Input/Output Adapter 
	5701	PCI 1 Gbps Ethernet UTP Input/Output Adapter 
	5706	PCI 1 Gbps Ethernet TX Input/Output Adapter 
	5707	PCI 1 Gbps Ethernet SX Input/Output Adapter 
	5718	PCI 10 Gbps Ethernet Input/Output Adapter 
Server cards		
Part number 45H2433 44H8677 connects to cable 45H2433  Video extension cable, 44H8676 	2891/2892	Netfinity Server Card 
	4810/9710	Integrated xSeries server card 
	4821/9712	Integrated xSeries server card
RAID disk unit controllers		
	2757	PCI Ultra RAID Disk Unit Controller
	2780	PCI-X Ultra4 RAID Disk Unit Controller

Table 14. Cables and adapters (continued)

Cables and connectors	Adapter type numbers	Adapters (located on the back of the server)
	5703/4778	PCI-X RAID Disk Unit Controller 
	5709	RAID Enabler Card
Fibre channel disk unit controllers		
	2787	PCI-X Fibre Channel Disk Unit Controller
PCI cryptography		
	4801/4758-023	PCI Cryptographic Coprocessor 
	4805/2058	PCI Cryptographic Accelerator
PCI-X tape unit controllers		
	5704	PCI-X Fibre Channel Tape Unit Controller 
	5702/5712/5715	PCI-X U320 Tape/Disk Unit Controller 
Bus adapters		
	2886	Optical Bus Adapter 
	2887	HSL-2 Bus Adapter 
	6417/28E7	HSL-2/RIO-G Bus Adapter 

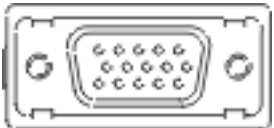
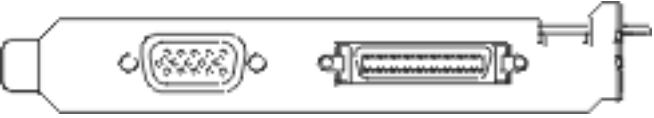
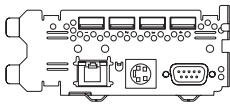
2. Connect the other end of the external cables to a network or device.
3. Continue with the next task.

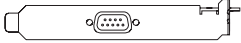
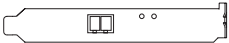
Turning on your server

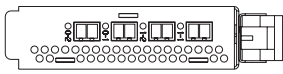
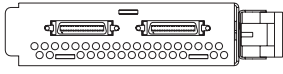
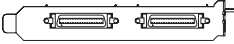
Before you turn on your server, complete these steps.

1. Plug in and turn on your console.
2. Plug in your server or uninterruptible power supply.

Note: If you are using two power cords, plug each power cord into a separate power source.

3. Plug in any attached expansion units.
4. Open the control panel on the front of the server. The control panel should be lit and display 01 BN V=F. The server is not yet powered on.

Note: If 01 BN V=F is not on the display, you might need to change the mode. If you need these instructions, go to the Accessing control panel functions topic in the information center.

5. Press the white Power On button. There is a short delay until the server starts to turn on. It takes 5 to 20 minutes. 01 BN V=F or A900 2000, which indicates the console is not connected yet, appears on the control panel when the server is powered on.
6. Install the back cover on the server, if you have previously removed it.
You have cabled your server.
7. Continue with the next task.

Note: If you plan to install any Linux specific hardware, or if you plan to create logical partitions on your iSeries, you might need to add or move some hardware, such as network I/O adapters, at this time. If you are unsure as to where to put the new or changed hardware, run the LPAR

Validation Tool (LVT) . You can find information about LPAR in the Logical partitions topic and additional information in the Linux in a logical partition topic of the information center.

Setting up your server

To set up your server, follow these instructions.

If you have a PC connected to the LAN, you can use EZ-Setup on the *iSeries Setup and Operations* CD-ROM to complete your server setup.

If you do not have a PC connected to the LAN, go to *Setting Up Your Twinaxial System*  to continue with your server setup.

Cabling a model 825 and Operations Console with an expansion unit

To connect the cables to your server and to the console, follow these instructions.

Print this topic using the Print key.

Note: If you are installing your server in a rack, see the *Installing System i features* topic.

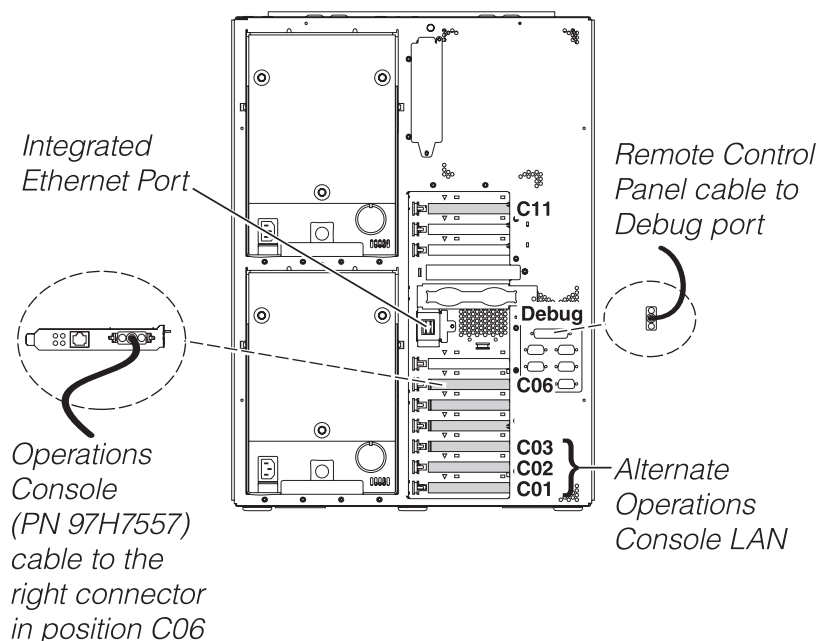

RZAM9905-3

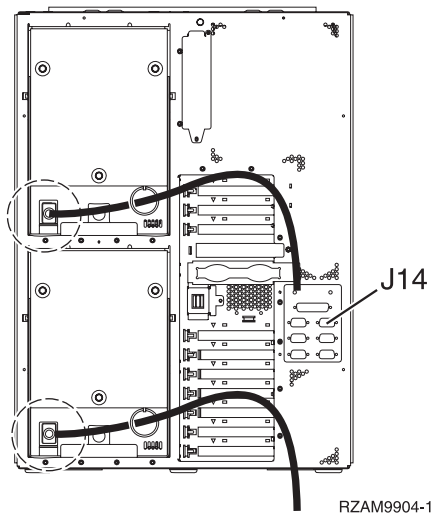
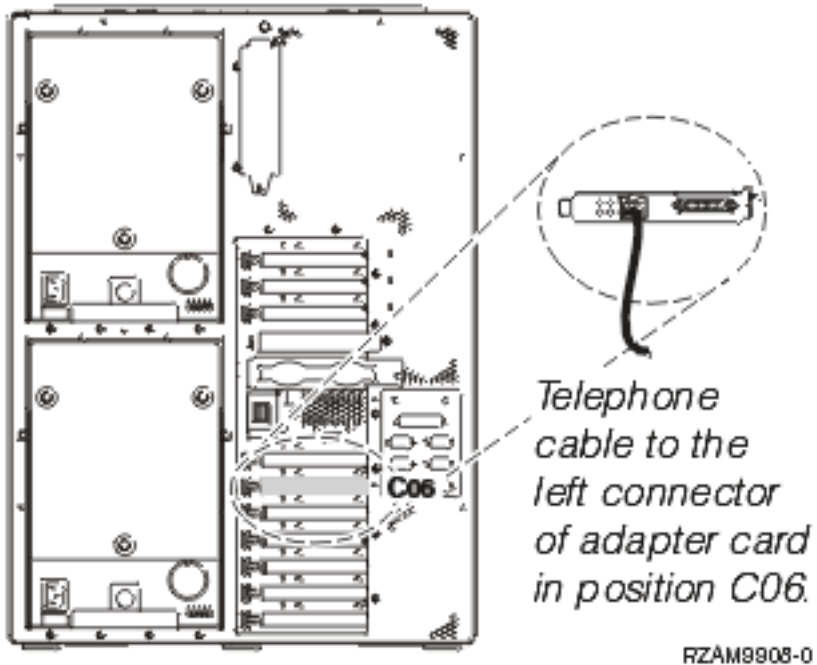

Connecting the Operations Console cable

To connect the Operations Console cable, follow these instructions.

1. Turn off and unplug the PC that is going to serve as the system console.
2. Locate the Operations Console cable (PN 97H7557). Connect the Operations Console cable to the right connector of the 2771 or 2793 adapter located in position C06 on the back of the server.

Are you using Operations Console with LAN connectivity?

- No
 - a. Connect the other end of the Operations Console cable to the first or only communications (serial) port on the back of the PC being used as the console.
 - b. Continue with the next task.
- Yes

If your primary choice is LAN connectivity, you do not need to connect the Operation Console cables to your PC at this time. If you develop a problem, you can connect these cables to the PC and configure Operations Console. See Operations Console.

- a. Connect a network cable from the integrated Ethernet port to your local area network. Card positions C03, C02, and C01 are only supported if the integrated Ethernet port is not operational.
- b. Continue with the next task.

Related information

Operations Console

Connecting the electronic customer support cable

To connect the electronic customer support cable, follow these instructions.

Are you installing electronic customer support?

- **No:** Continue with the next task.
- **Yes:**
 1. Connect a telephone cable to the left connector of the adapter located in position C06.
 2. Connect the other end of the telephone cable to an analog telephone jack.

Electronic customer support helps automate management of your server and streamline your support. Find out more about electronic customer support by looking at the IBM System i Technical Support





Advantage information included with your server, or go to the Support for IBM System i  Web site. Electronic customer support can be configured using the *iSeries Setup and Operations* CD-ROM that came with your server.

Continue with the next task.

Cabling the expansion unit

To cable the expansion unit, follow these instructions.

Note: Do not plug the expansion-unit power cord into the power outlet as directed by the following documents.

- Setting Up Your 0578, 5074, 5078, or 5079 Expansion Unit 
- Setting Up Your 5075 Expansion Unit 
- Setting Up Your 5065 or 5066 Expansion Unit 
- Setting Up Your 0588, 0595, 5088, 5094, 5095 or 5294 Expansion Unit 

After you have set up the expansion unit, continue with the next task.

Connecting the power cords

To connect the power cords, follow these instructions.

If you have a 4758 PCI Cryptographic Coprocessor card to install, go to the instructions that came with the card. This card was shipped in a separate box. Return here after the card is installed.

Note: If you are using two power cords, route them through the retainer ring as shown below after you connect them to the server.

Are you installing an uninterruptible power supply?

- **No:** Connect the server power cords to the server.

Note: Do not plug the power cord into the power outlet. Do not turn on your server.

Continue with the next task.

- **Yes:** Connect the power control cable for the uninterruptible power supply to J14. Do not plug the power cord of the uninterruptible power supply into the outlet and do not turn on your server. For instructions to complete the installation of the uninterruptible power supply, go to the Web site Powerware UPS Solutions for IBM

(<http://www.oem.powerware.com/ibm-ups/Products/9910Solutions/ina.asp>) .

Continue with the next task.

Connecting external cables

To connect external cables, follow these instructions.

If you do not have any external cables to connect to the adapter cards on the back of your server or expansion unit, continue with the next task.

1. Use this table to connect the cables to the matching adapters on the back of your server. You might need to connect more than one cable.

Note: If the cable did not come with your server, then you need to supply it.

Table 15. Cables and adapters





Cables and connectors	Adapter type numbers	Adapters (located on the back of the server)
PCI two-line WAN		
44H7xxx or 97H73xx 	4745/2745/2742	PCI Two-line WAN Input/Output Adapter 
44H7xxx, 97H73xx, or 44H748x  Integrated modem 87G62xx, 21H49xx, or 75G38xx 	2793/2794/2771	PCI Two-line WAN with Modem Input/Output Adapter 
PCI dual WAN		
Integrated modem 87G62xx, 21H49xx, or 75G38xx 	2772/2773	PCI Dual WAN with Modem Input/Output Adapter 
PCI twinaxial		
Part number 12F5093 	4746/9746/2746	PCI Twinaxial Workstation Controller Input/Output Adapter 

Table 15. Cables and adapters (continued)



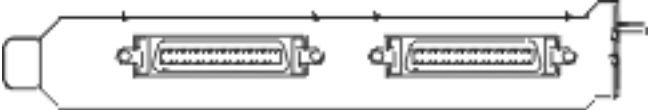
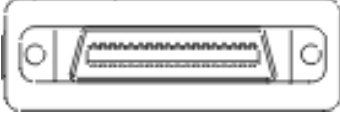

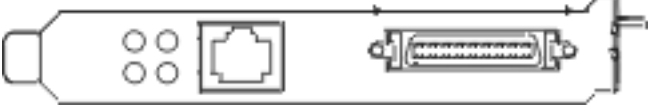

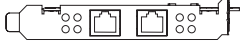
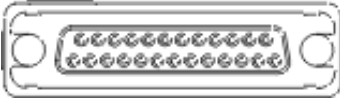
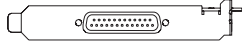



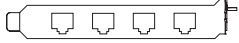

Cables and connectors	Adapter type numbers	Adapters (located on the back of the server)
PCI token-ring		
RJ45 Token-ring  Filter P75G5958 or 75G2865  6339098 	2744/4959	PCI 4/16/100 Mbps Token-Ring Input/Output Adapter 
PCI quad		
	2805/2806	PCI Quad Modem Input/Output Adapter 
	6312	PCI Quad Digital Trunk Adapter 
Ethernet		
RJ45 Ethernet 	2838/2849	PCI 100/10 Mbps Ethernet Input/Output Adapter 
	5700	PCI 1 Gbps Ethernet Input/Output Adapter 
	5701	PCI 1 Gbps Ethernet UTP Input/Output Adapter 
	5706	PCI 1 Gbps Ethernet TX Input/Output Adapter 
	5707	PCI 1 Gbps Ethernet SX Input/Output Adapter 
	5718	PCI 10 Gbps Ethernet Input/Output Adapter 
Server cards		

Table 15. Cables and adapters (continued)



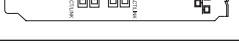

Cables and connectors	Adapter type numbers	Adapters (located on the back of the server)
<p>Part number 45H2433</p> <p>44H8677 connects to cable 45H2433</p>  <p>Video extension cable, 44H8676</p> 	2891/2892	<p>Netfinity Server Card</p> 
	4810/9710	<p>Integrated xSeries server card</p> 
	4821/9712	<p>Integrated xSeries server card</p>
RAID disk unit controllers		
	2757	<p>PCI Ultra RAID Disk Unit Controller</p>
	2780	<p>PCI-X Ultra4 RAID Disk Unit Controller</p>
	5703/4778	<p>PCI-X RAID Disk Unit Controller</p> 
	5709	<p>RAID Enabler Card</p>
Fibre channel disk unit controllers		
	2787	<p>PCI-X Fibre Channel Disk Unit Controller</p>
PCI cryptography		
	4801/4758-023	<p>PCI Cryptographic Coprocessor</p> 
	4805/2058	<p>PCI Cryptographic Accelerator</p>
PCI-X tape unit controllers		
	5704	<p>PCI-X Fibre Channel Tape Unit Controller</p> 
	5702/5712/5715	<p>PCI-X U320 Tape/Disk Unit Controller</p> 
Bus adapters		
	2886	<p>Optical Bus Adapter</p> 

Table 15. Cables and adapters (continued)

Cables and connectors	Adapter type numbers	Adapters (located on the back of the server)
	2887	HSL-2 Bus Adapter 
	6417/28E7	HSL-2/RIO-G Bus Adapter 

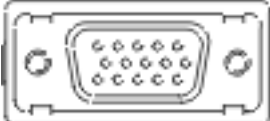
2. Connect the other end of the external cables to a network or device.
3. Continue with the next task.

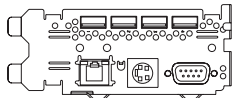
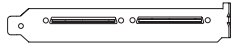
Turning on your server

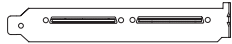
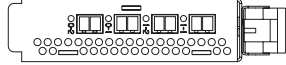
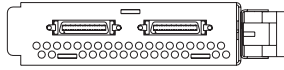
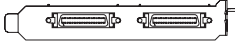
Before you turn on your server, complete these steps.

1. Plug in and turn on your console.
2. Plug in your server or uninterruptible power supply.

Note: If you are using two power cords, plug each power cord into a separate power source.

3. Plug in any attached expansion units.
4. Open the control panel on the front of the server. The control panel should be lit and display 01 BN V=F. The server is not yet powered on.

Note: If 01 BN V=F is not on the display, you might need to change the mode. If you need these instructions, go to the Accessing control panel functions topic in the information center.

5. Press the white Power On button. There is a short delay until the server starts to turn on. It takes 5 to 20 minutes. 01 BN V=F or A900 2000, which indicates the console is not connected yet, appears on the control panel when the server is powered on.
6. Install the back cover on the server, if you have previously removed it.
You have cabled your server.
7. Continue with the next task.

Note: If you plan to install any Linux specific hardware, or if you plan to create logical partitions on your iSeries, you might need to add or move some hardware, such as network I/O adapters, at this time. If you are unsure as to where to put the new or changed hardware, run the LPAR

Validation Tool (LVT)  . You can find information about LPAR in the Logical partitions topic and additional information in the Linux in a logical partition topic of the information center.

Setting up your server

To continue to set up your server, return to EZ-Setup on the *iSeries Setup and Operations* CD-ROM.

Cabling a model 825 and Operations Console without an expansion unit

To connect the cables to your server and to the console, follow these instructions.

Print this topic using the Print key.

Note: If you are installing your server in a rack, see the Installing System i features topic.

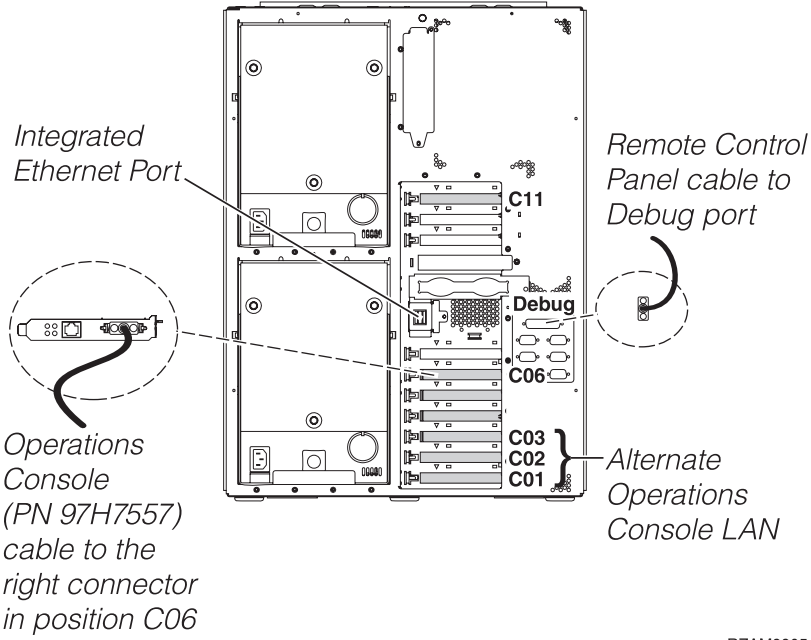

RZAM9905-3

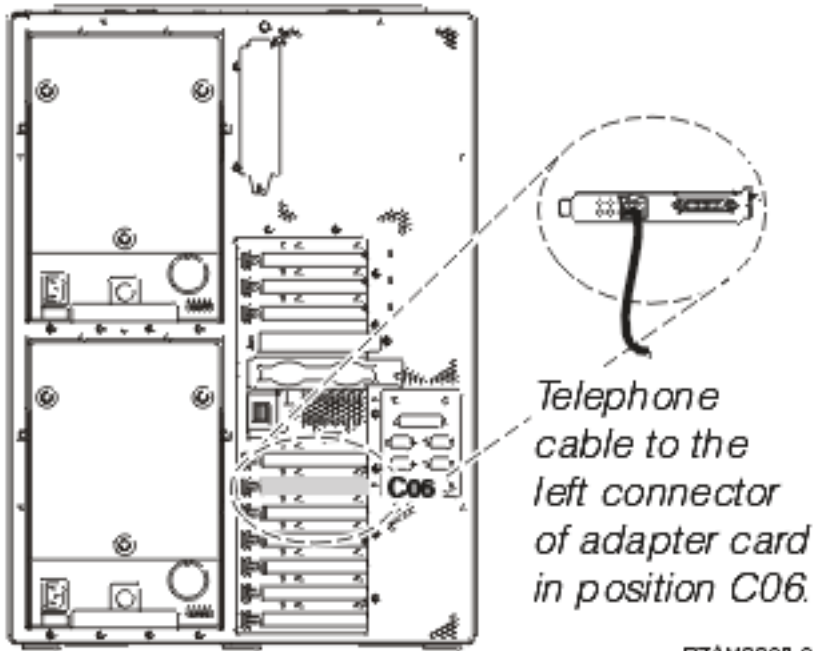

RZAM9908-0

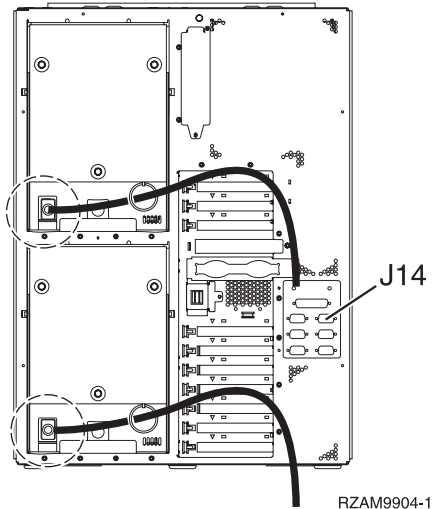

Connecting the Operations Console cable

To connect the Operations Console cable, follow these instructions.

1. Turn off and unplug the PC that is going to serve as the system console.
2. Locate the Operations Console cable (PN 97H7557). Connect the Operations Console cable to the right connector of the 2771 or 2793 adapter located in position C06 on the back of the server.

Are you using Operations Console with LAN connectivity?

- **No**

- a. Connect the other end of the Operations Console cable to the first or only communications (serial) port on the back of the PC being used as the console.
- b. Continue with the next task.

- **Yes**

If your primary choice is LAN connectivity, you do not need to connect the Operation Console cables to your PC at this time. If you develop a problem, you can connect these cables to the PC and configure Operations Console. See Operations Console.

- a. Connect a network cable from the integrated Ethernet port to your local area network. Card positions C03, C02, and C01 are only supported if the integrated Ethernet port is not operational.
- b. Continue with the next task.

Connecting the electronic customer support cable

To connect the electronic customer support cable, follow these instructions.

Are you installing electronic customer support?

- **No:** Continue with the next task.

- **Yes:**

1. Connect a telephone cable to the left connector of the adapter located in position C06.
2. Connect the other end of the telephone cable to an analog telephone jack.

Electronic customer support helps automate management of your server and streamline your support. Find out more about electronic customer support by looking at the IBM System i Technical Support

Advantage information included with your server, or go to the Support for IBM System i  Web site. Electronic customer support can be configured using the *iSeries Setup and Operations* CD-ROM that came with your server.

Continue with the next task.

Connecting the power cords

To connect the power cords, follow these instructions.

If you have a 4758 PCI Cryptographic Coprocessor card to install, go to the instructions that came with the card. This card was shipped in a separate box. Return here after the card is installed.

Note: If you are using two power cords, route them through the retainer ring as shown below after you connect them to the server.

Are you installing an uninterruptible power supply?

- **No:** Connect the server power cords to the server.

Note: Do not plug the power cord into the power outlet. Do not turn on your server.

Continue with the next task.

- **Yes:** Connect the power control cable for the uninterruptible power supply to J14. Do not plug the power cord of the uninterruptible power supply into the outlet and do not turn on your server. For instructions to complete the installation of the uninterruptible power supply, go to the Web site Powerware UPS Solutions for IBM

(<http://www.oem.powerware.com/ibm-ups/Products/9910Solutions/ina.asp>) .

Continue with the next task.

Connecting external cables

To connect external cables, follow these instructions.

If you do not have any external cables to connect to the adapter cards on the back of your server or expansion unit, continue with the next task.

1. Use this table to connect the cables to the matching adapters on the back of your server. You might need to connect more than one cable.

Note: If the cable did not come with your server, then you need to supply it.

Table 16. Cables and adapters





Cables and connectors	Adapter type numbers	Adapters (located on the back of the server)
PCI two-line WAN		
44H7xxx or 97H73xx 	4745/2745/2742	PCI Two-line WAN Input/Output Adapter 
44H7xxx, 97H73xx, or 44H748x 	2793/2794/2771	PCI Two-line WAN with Modem Input/Output Adapter 
Integrated modem 87G62xx, 21H49xx, or 75G38xx 		
PCI dual WAN		

Table 16. Cables and adapters (continued)



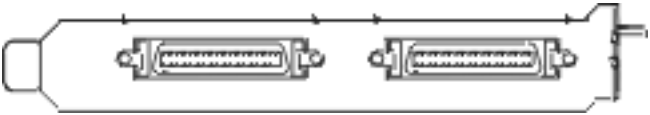



Cables and connectors	Adapter type numbers	Adapters (located on the back of the server)
<p>Integrated modem</p> <p>87G62xx, 21H49xx, or 75G38xx</p> 	2772/2773	<p>PCI Dual WAN with Modem Input/Output Adapter</p> 
PCI twinaxial		
<p>Part number 12F5093</p> 	4746/9746/2746	<p>PCI Twinaxial Workstation Controller Input/Output Adapter</p> 
PCI token-ring		
<p>RJ45 Token-ring</p>  <p>Filter P75G5958 or 75G2865</p>  <p>6339098</p> 	2744/4959	<p>PCI 4/16/100 Mbps Token-Ring Input/Output Adapter</p> 
PCI quad		
	2805/2806	<p>PCI Quad Modem Input/Output Adapter</p> 
	6312	<p>PCI Quad Digital Trunk Adapter</p> 
Ethernet		

Table 16. Cables and adapters (continued)

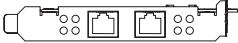
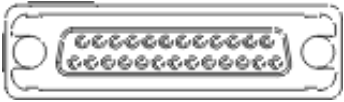
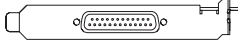



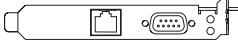

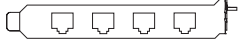



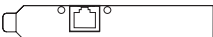
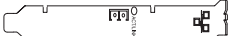

Cables and connectors	Adapter type numbers	Adapters (located on the back of the server)
RJ45 Ethernet 	2838/2849	PCI 100/10 Mbps Ethernet Input/Output Adapter 
	5700	PCI 1 Gbps Ethernet Input/Output Adapter 
	5701	PCI 1 Gbps Ethernet UTP Input/Output Adapter 
	5706	PCI 1 Gbps Ethernet TX Input/Output Adapter 
	5707	PCI 1 Gbps Ethernet SX Input/Output Adapter 
	5718	PCI 10 Gbps Ethernet Input/Output Adapter 
Server cards		
Part number 45H2433 44H8677 connects to cable 45H2433  Video extension cable, 44H8676 	2891/2892	Netfinity Server Card 
	4810/9710	Integrated xSeries server card 
	4821/9712	Integrated xSeries server card 
RAID disk unit controllers		
	2757	PCI Ultra RAID Disk Unit Controller 
	2780	PCI-X Ultra4 RAID Disk Unit Controller 
	5703/4778	PCI-X RAID Disk Unit Controller 
	5709	RAID Enabler Card 
Fibre channel disk unit controllers		

Table 16. Cables and adapters (continued)

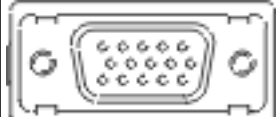
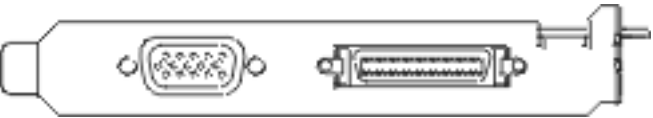
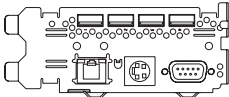
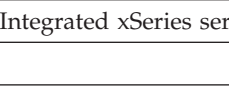
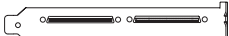
Cables and connectors	Adapter type numbers	Adapters (located on the back of the server)
	2787	PCI-X Fibre Channel Disk Unit Controller
PCI cryptography		
	4801/4758-023	PCI Cryptographic Coprocessor 
	4805/2058	PCI Cryptographic Accelerator
PCI-X tape unit controllers		
	5704	PCI-X Fibre Channel Tape Unit Controller 
	5702/5712/5715	PCI-X U320 Tape/Disk Unit Controller 
Bus adapters		
	2886	Optical Bus Adapter 
	2887	HSL-2 Bus Adapter 
	6417/28E7	HSL-2/RIO-G Bus Adapter 

2. Connect the other end of the external cables to a network or device.
3. Continue with the next task.

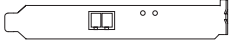
Turning on your server

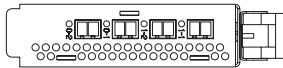
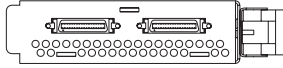
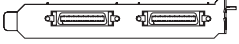
Before you turn on your server, complete these steps.

1. Plug in and turn on your console.
2. Plug in your server or uninterruptible power supply.

Note: If you are using two power cords, plug each power cord into a separate power source.

3. Plug in any attached expansion units.
4. Open the control panel on the front of the server. The control panel should be lit and display 01 BN V=F. The server is not yet powered on.

Note: If 01 BN V=F is not on the display, you might need to change the mode. If you need these instructions, go to the Accessing control panel functions topic in the information center.

5. Press the white Power On button. There is a short delay until the server starts to turn on. It takes 5 to 20 minutes. 01 BN V=F or A900 2000, which indicates the console is not connected yet, appears on the control panel when the server is powered on.
6. Install the back cover on the server, if you have previously removed it.
You have cabled your server.
7. Continue with the next task.

Note: If you plan to install any Linux specific hardware, or if you plan to create logical partitions on your iSeries, you might need to add or move some hardware, such as network I/O adapters, at this time. If you are unsure as to where to put the new or changed hardware, run the LPAR

Validation Tool (LVT)  . You can find information about LPAR in the Logical partitions topic and additional information in the Linux in a logical partition topic of the information center.

Related tasks

“Cabling your rack” on page 113

To use the cable management arm and fasteners provided with the rack, follow these steps. The rack has a cable management arm and fasteners that help manage excess cabling and secure your cables within the rack. The steps in this topic describe how to use the cable management arm and fasteners provided with the rack.

Setting up your server

To continue to set up your server, return to EZ-Setup on the *iSeries Setup and Operations* CD-ROM.

Related tasks

“Cabling your rack” on page 113

To use the cable management arm and fasteners provided with the rack, follow these steps. The rack has a cable management arm and fasteners that help manage excess cabling and secure your cables within the rack. The steps in this topic describe how to use the cable management arm and fasteners provided with the rack.

Cabling a model 890 or model 870 Operations Console

To connect the cables to your server and to the console, follow these instructions.

Print this topic using the Print key.

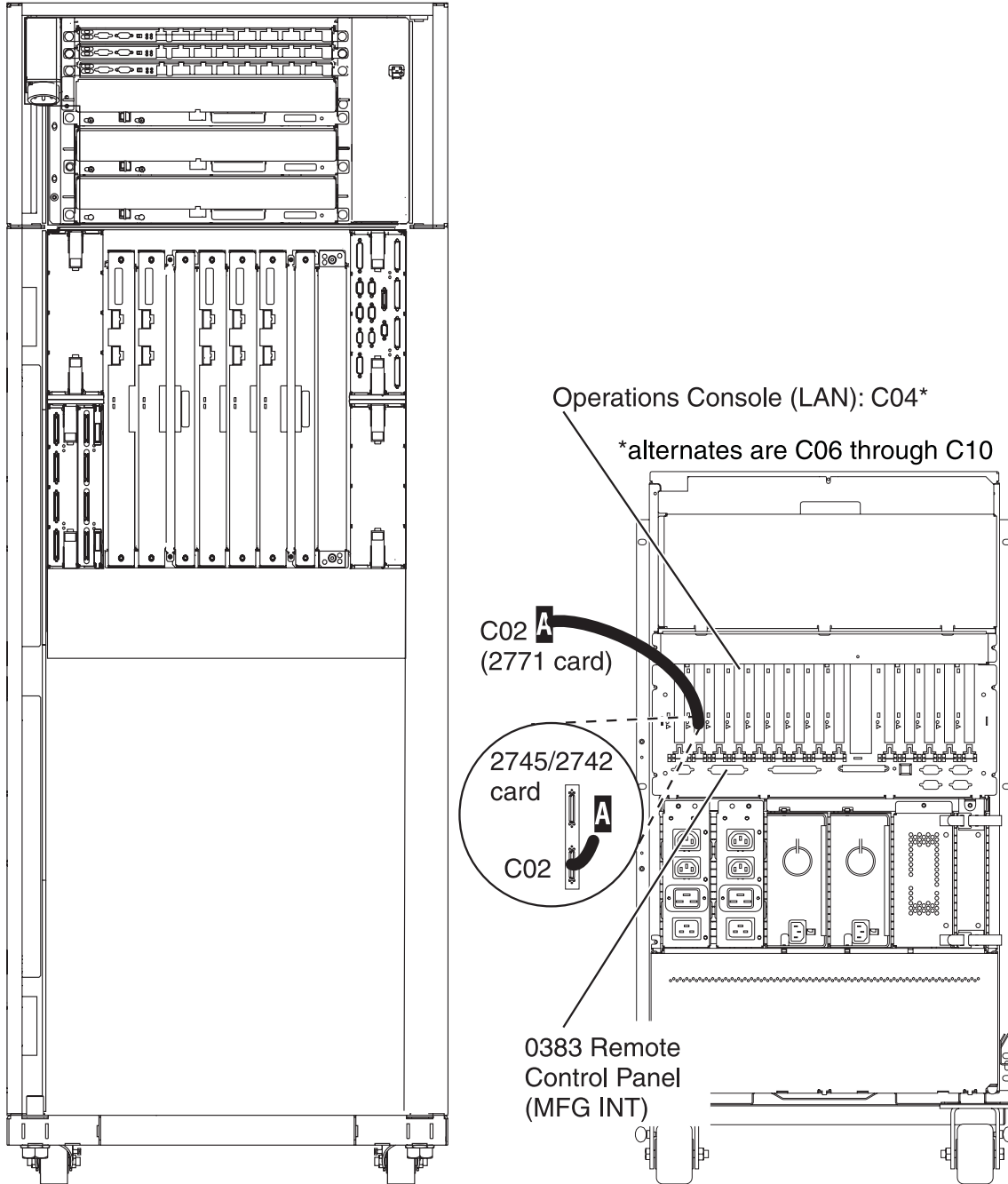

RZAJR512-3

Setting up a rack

To set up a rack, follow these instructions.

Print this topic using the Print key.

Installing the front tip plate

A front tip plate must be attached to the bottom of the rack for safety reasons. The tip plate is included in one of the boxes you received with your rack. To install the front tip plate, follow these instructions.

CAUTION:

The tip plate must be firmly attached to the bottom front of the rack to prevent the rack from turning over when the servers are pulled out of the rack. Do not pull out a server or install any feature until the tip plate is attached to the rack.

1. Align the slots in the tip plate with the mounting holes in the bottom front of the rack.
2. Ensure that the base of the tip plate rests firmly on the floor.
3. Install the two mounting screws using the tool provided.

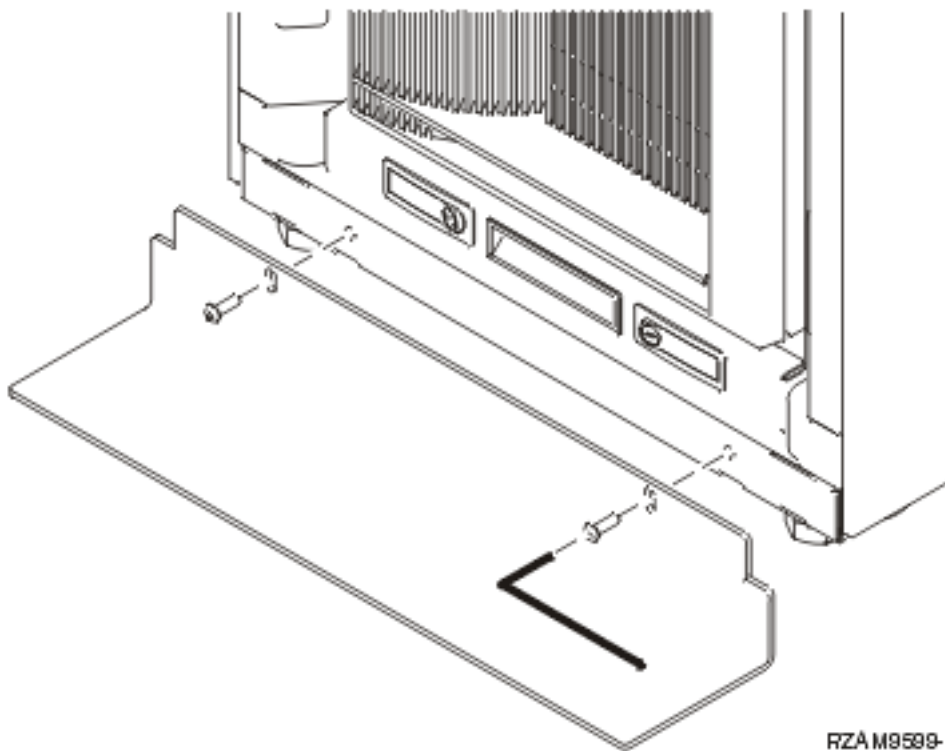

4. Do the following steps:
 - a. If your rack contains only a 5074, 5078, or 5079 expansion unit, go to Setting Up Your 0578, 5074, 5078, or 5079 Expansion Unit. 
 - b. Go to “Cabling your rack” on page 113 to connect the power cords to the power distribution unit (skip the steps to cable the server).
5. If you have servers in your rack, continue with the next task.

Removing the shipping brackets

Before you can install features, you need to access the inside of the servers. To remove the shipping brackets from your server, follow these instructions.

1. Remove the screws A that attach each of the four shipping brackets to the front of the rack.

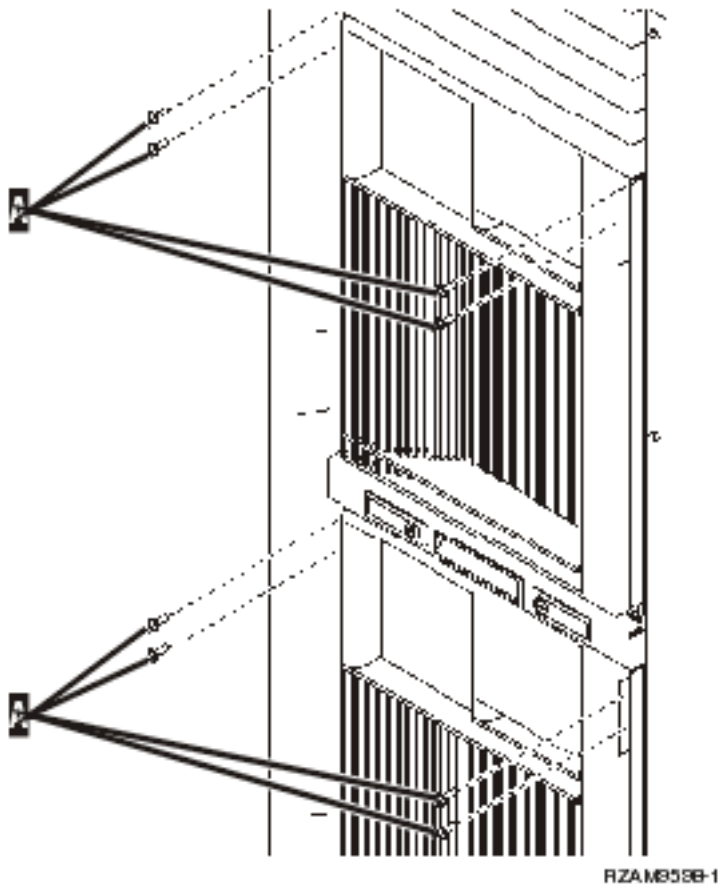

2. Move to the back of the rack, press the latch B, and open the door.

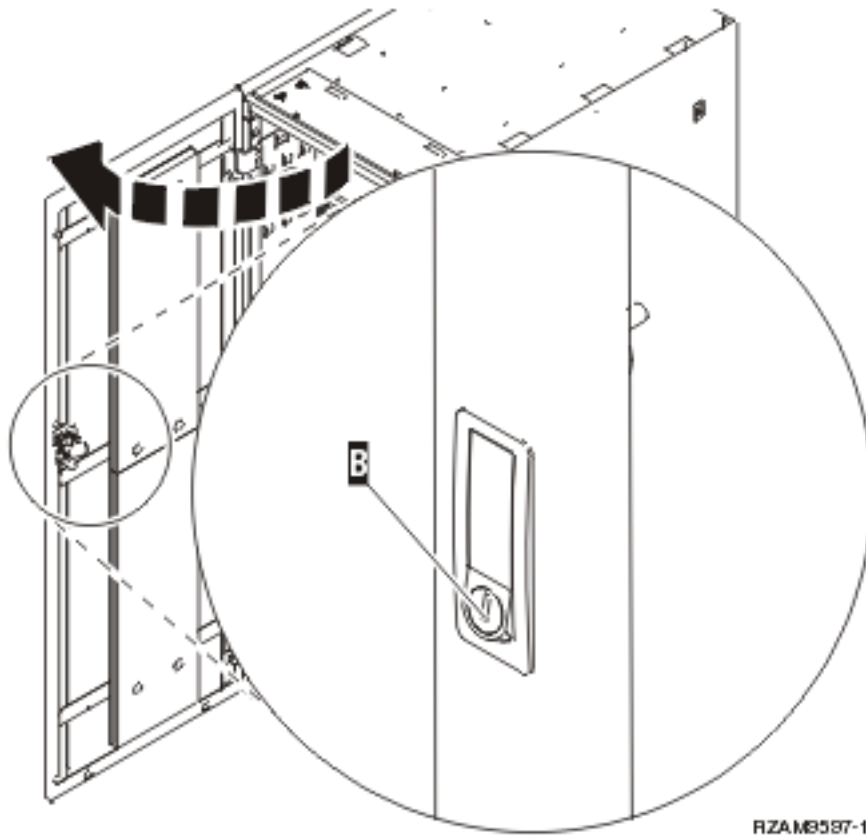

3. Remove the screws that attach each of the four angle brackets C located on the sides of the server trays.

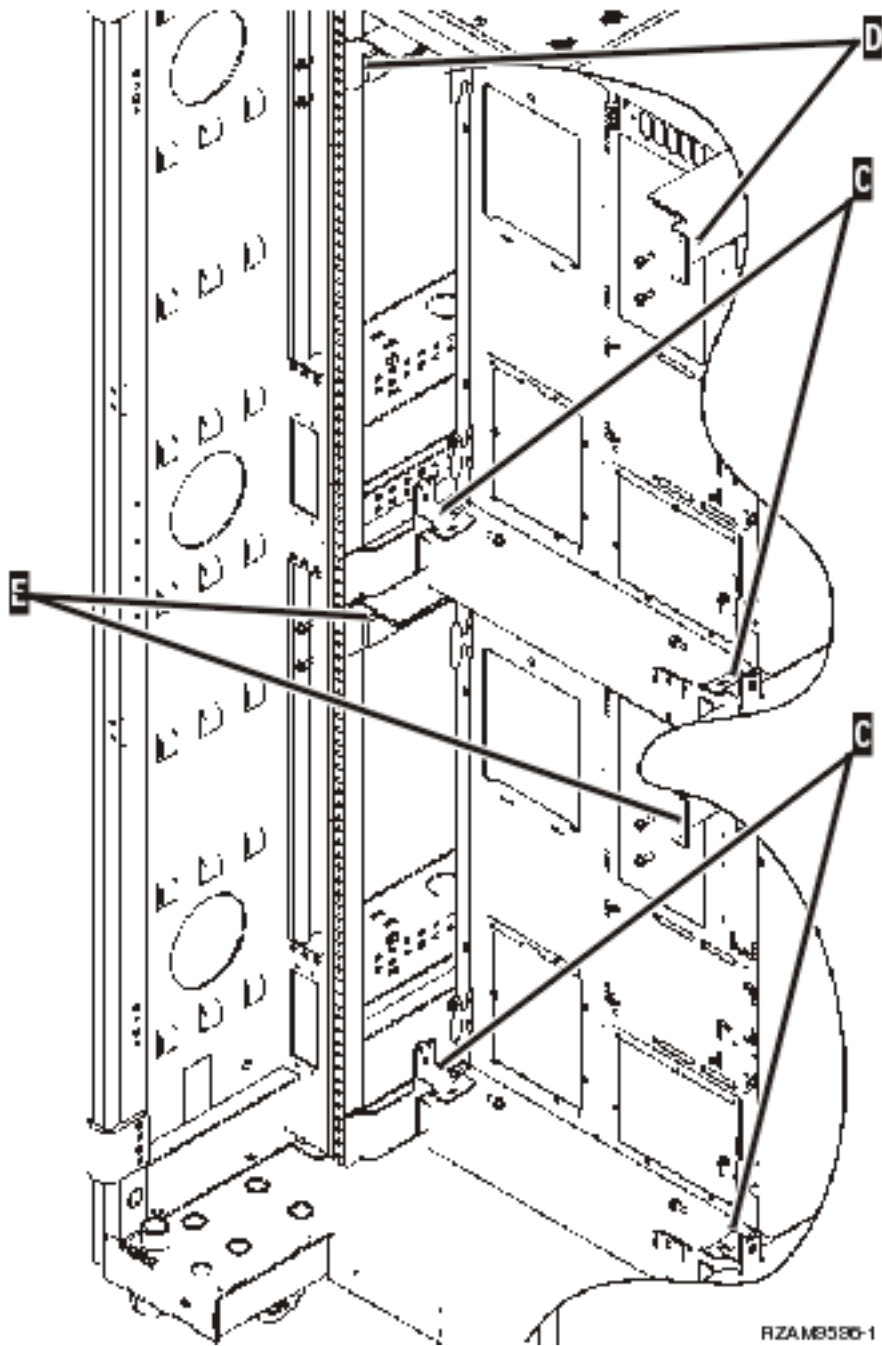

4. Remove the screws that attach the upper shipping brackets D to the back of the rack.
5. Remove the two shipping brackets D from the upper server through the back of the rack. Push up firmly to remove them.

Note: Save the shipping brackets and use them if the rack is moved in the future.

6. Go to the front of the rack.
7. Press the latches F and pull the lower server out using the handle G.

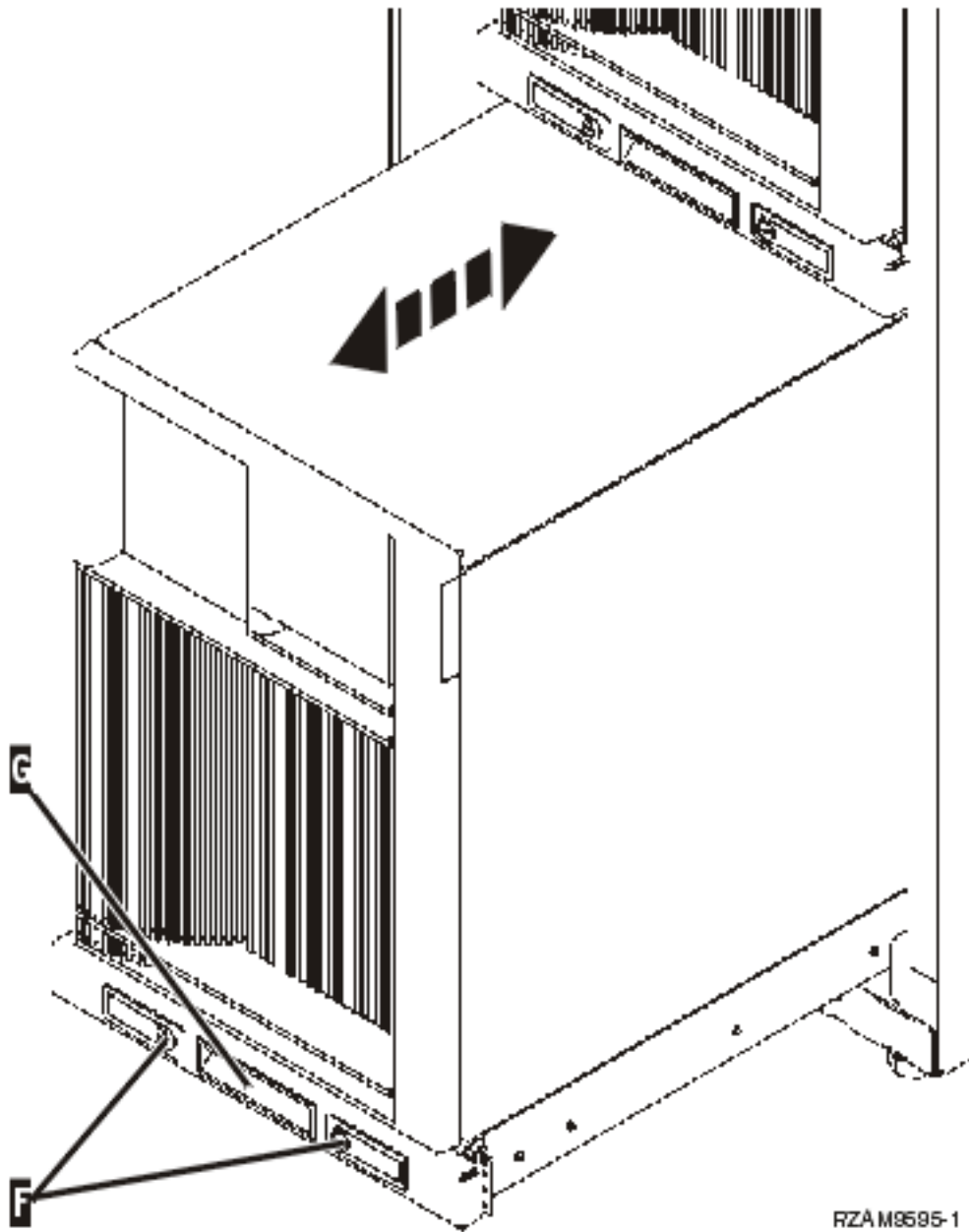

8. Go to the back of the rack.
9. While supporting the lower shipping brackets, remove the screws E that attach the brackets to the rack. Remove the shipping brackets from the back of the rack.

Note: Save the shipping brackets and use them if the rack is moved in the future.

10. Slide the server back into the rack.

Cabling your rack

To use the cable management arm and fasteners provided with the rack, follow these steps. The rack has a cable management arm and fasteners that help manage excess cabling and secure your cables within the rack. The steps in this topic describe how to use the cable management arm and fasteners provided with the rack.

Attention: Because each server in your rack is unique, each server has its own box of cables and materials. Before you begin the cabling process, verify that you are using the correct cables and documentation for the server you are cabling. You can determine which box is for which server by comparing the serial number on the server to the serial number on the container label located on the outside of the ship group container or the packing slip in the box. The serial number is located on the control panel of each server. Cable one server at a time, being sure to use the correct cabling poster for the server you are cabling.

1. Cable the server using the 270 cabling instructions but do not turn on the server. Return to these instructions and continue with the next step.

Note: The servers within the rack are shipped without back covers, so there is no need to remove the back covers as stated in the cabling instructions.

2. After cabling the server, press the latches on the front of the server tray and use the center handle to slide the server out.
3. When the server tray is fully extended, feed the excess cabling along the cable management arm H and secure the cables with the fasteners, as shown. Be sure to allow excess cable at the cable management arm hinge so that you can slide the server tray all the way in without pulling on the cables.

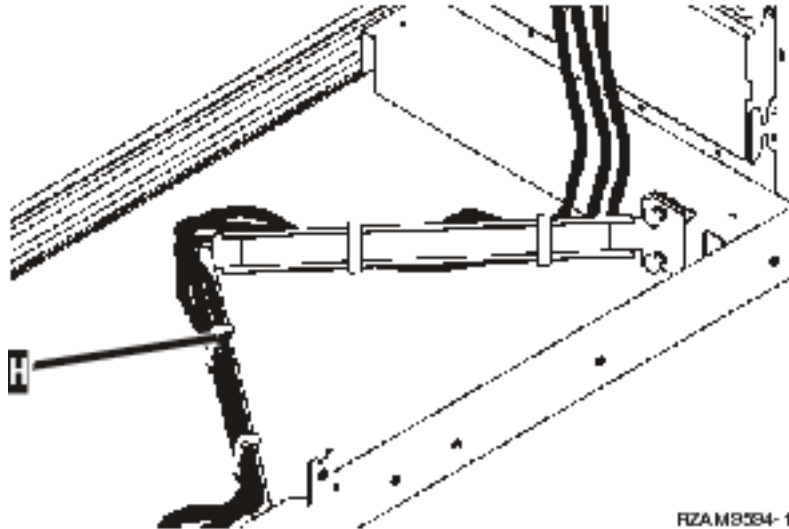

4. Slide the server back into the rack.

Note: Arrange the power cords to meet any local codes or regulations you might have.

5. If you are using a power distribution unit, connect the power cords to it as shown below.

Note: The power distribution unit is optional, and you have one to four power distribution units. Connect the power cord from the power distribution unit to the wall outlet. If you are using two power cords, plug each power cord into a separate power source.

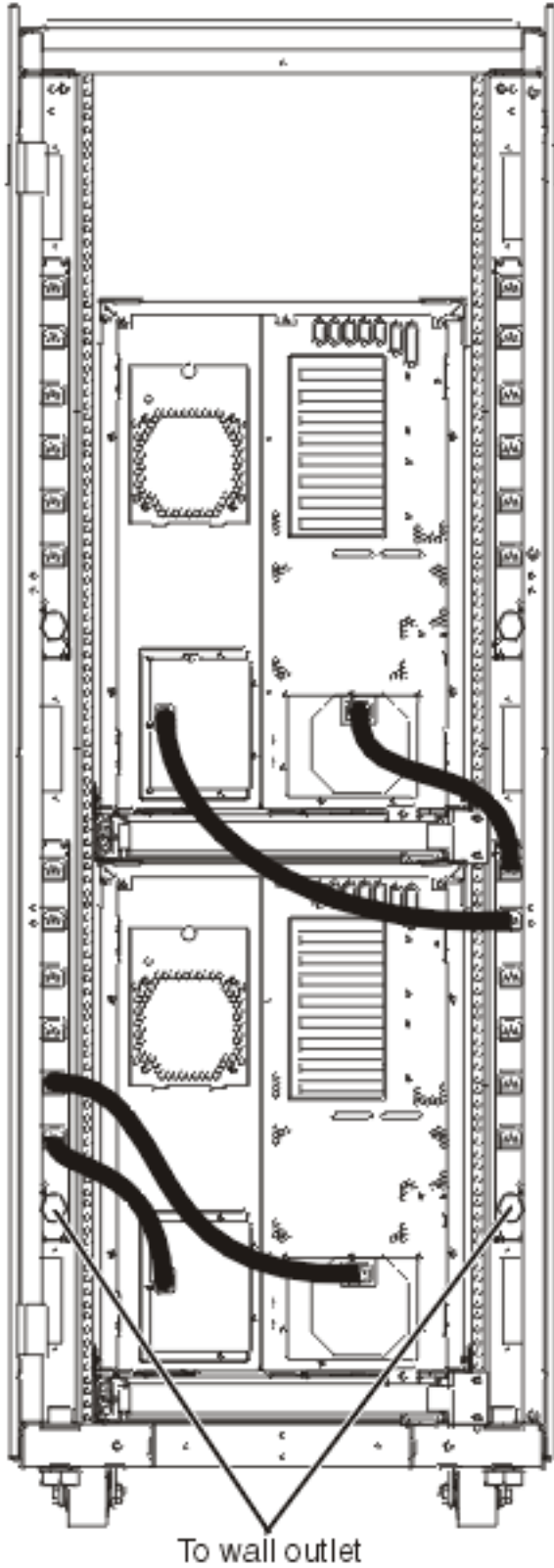

RZAMB58G-1

6. Refer to the cabling instructions section, see Turning on your server and continue cabling your server.

7. Repeat this whole procedure if you have another server in your rack.
8. When you are done with the cabling and server setup, close the back door of the rack.
9. Put the brackets that secure the trim back on the rack. These brackets were removed during unpacking.
10. Return to the cabling instructions section, see Setting up your server and complete the server setup.

Related tasks

“Turning on your server” on page 106

Before you turn on your server, complete these steps.

Related reference

“Selecting the model 270 cabling instructions” on page 1

Before you connect cables to your server, select the cabling instructions that best match the server you are setting up.

“Setting up your server” on page 107

To continue to set up your server, return to EZ-Setup on the *iSeries Setup and Operations* CD-ROM.

Appendix. Notices

This information was developed for products and services offered in the U.S.A.

IBM may not offer the products, services, or features discussed in this document in other countries. Consult your local IBM representative for information on the products and services currently available in your area. Any reference to an IBM product, program, or service is not intended to state or imply that only that IBM product, program, or service may be used. Any functionally equivalent product, program, or service that does not infringe any IBM intellectual property right may be used instead. However, it is the user's responsibility to evaluate and verify the operation of any non-IBM product, program, or service.

IBM may have patents or pending patent applications covering subject matter described in this document. The furnishing of this document does not grant you any license to these patents. You can send license inquiries, in writing, to:

IBM Director of Licensing
IBM Corporation
North Castle Drive
Armonk, NY 10504-1785
U.S.A.

For license inquiries regarding double-byte (DBCS) information, contact the IBM Intellectual Property Department in your country or send inquiries, in writing, to:

IBM World Trade Asia Corporation
Licensing
2-31 Roppongi 3-chome, Minato-ku
Tokyo 106-0032, Japan

The following paragraph does not apply to the United Kingdom or any other country where such provisions are inconsistent with local law: INTERNATIONAL BUSINESS MACHINES CORPORATION PROVIDES THIS PUBLICATION "AS IS" WITHOUT WARRANTY OF ANY KIND, EITHER EXPRESS OR IMPLIED, INCLUDING, BUT NOT LIMITED TO, THE IMPLIED WARRANTIES OF NON-INFRINGEMENT, MERCHANTABILITY OR FITNESS FOR A PARTICULAR PURPOSE. Some states do not allow disclaimer of express or implied warranties in certain transactions, therefore, this statement may not apply to you.

This information could include technical inaccuracies or typographical errors. Changes are periodically made to the information herein; these changes will be incorporated in new editions of the publication. IBM may make improvements and/or changes in the product(s) and/or the program(s) described in this publication at any time without notice.

Any references in this information to non-IBM Web sites are provided for convenience only and do not in any manner serve as an endorsement of those Web sites. The materials at those Web sites are not part of the materials for this IBM product and use of those Web sites is at your own risk.

IBM may use or distribute any of the information you supply in any way it believes appropriate without incurring any obligation to you.

Licensees of this program who wish to have information about it for the purpose of enabling: (i) the exchange of information between independently created programs and other programs (including this one) and (ii) the mutual use of the information which has been exchanged, should contact:

IBM Corporation

Software Interoperability Coordinator, Department YBWA
3605 Highway 52 N
Rochester, MN 55901
U.S.A.

Such information may be available, subject to appropriate terms and conditions, including in some cases, payment of a fee.

- | The licensed program described in this information and all licensed material available for it are provided
- | by IBM under terms of the IBM Customer Agreement, IBM International Program License Agreement,
- | IBM License Agreement for Machine Code, or any equivalent agreement between us.

Any performance data contained herein was determined in a controlled environment. Therefore, the results obtained in other operating environments may vary significantly. Some measurements may have been made on development-level systems and there is no guarantee that these measurements will be the same on generally available systems. Furthermore, some measurements may have been estimated through extrapolation. Actual results may vary. Users of this document should verify the applicable data for their specific environment.

Information concerning non-IBM products was obtained from the suppliers of those products, their published announcements or other publicly available sources. IBM has not tested those products and cannot confirm the accuracy of performance, compatibility or any other claims related to non-IBM products. Questions on the capabilities of non-IBM products should be addressed to the suppliers of those products.

All statements regarding IBM's future direction or intent are subject to change or withdrawal without notice, and represent goals and objectives only.

All IBM prices shown are IBM's suggested retail prices, are current and are subject to change without notice. Dealer prices may vary.

This information is for planning purposes only. The information herein is subject to change before the products described become available.

This information contains examples of data and reports used in daily business operations. To illustrate them as completely as possible, the examples include the names of individuals, companies, brands, and products. All of these names are fictitious and any similarity to the names and addresses used by an actual business enterprise is entirely coincidental.

COPYRIGHT LICENSE:

This information contains sample application programs in source language, which illustrate programming techniques on various operating platforms. You may copy, modify, and distribute these sample programs in any form without payment to IBM, for the purposes of developing, using, marketing or distributing application programs conforming to the application programming interface for the operating platform for which the sample programs are written. These examples have not been thoroughly tested under all conditions. IBM, therefore, cannot guarantee or imply reliability, serviceability, or function of these programs.

Each copy or any portion of these sample programs or any derivative work, must include a copyright notice as follows:

© (your company name) (year). Portions of this code are derived from IBM Corp. Sample Programs. © Copyright IBM Corp. _enter the year or years_. All rights reserved.

If you are viewing this information softcopy, the photographs and color illustrations may not appear.

Trademarks

The following terms are trademarks of International Business Machines Corporation in the United States, other countries, or both:

- | IBM
 - | IBM (logo)
 - | iSeries
 - | Netfinity
 - | System i
 - | xSeries
- | Linux is a registered trademark of Linus Torvalds in the United States, other countries, or both.

Other company, product, and service names may be trademarks or service marks of others.

Terms and conditions

Permissions for the use of these publications is granted subject to the following terms and conditions.

Personal Use: You may reproduce these publications for your personal, noncommercial use provided that all proprietary notices are preserved. You may not distribute, display or make derivative works of these publications, or any portion thereof, without the express consent of IBM.

Commercial Use: You may reproduce, distribute and display these publications solely within your enterprise provided that all proprietary notices are preserved. You may not make derivative works of these publications, or reproduce, distribute or display these publications or any portion thereof outside your enterprise, without the express consent of IBM.

Except as expressly granted in this permission, no other permissions, licenses or rights are granted, either express or implied, to the publications or any information, data, software or other intellectual property contained therein.

IBM reserves the right to withdraw the permissions granted herein whenever, in its discretion, the use of the publications is detrimental to its interest or, as determined by IBM, the above instructions are not being properly followed.

You may not download, export or re-export this information except in full compliance with all applicable laws and regulations, including all United States export laws and regulations.

IBM MAKES NO GUARANTEE ABOUT THE CONTENT OF THESE PUBLICATIONS. THE PUBLICATIONS ARE PROVIDED "AS-IS" AND WITHOUT WARRANTY OF ANY KIND, EITHER EXPRESSED OR IMPLIED, INCLUDING BUT NOT LIMITED TO IMPLIED WARRANTIES OF MERCHANTABILITY, NON-INFRINGEMENT, AND FITNESS FOR A PARTICULAR PURPOSE.



Printed in USA