



Cisco Unified IP Phone 7906G and 7911G for Cisco Unified CallManager 5.1 (SCCP and SIP)



INCLUDING LICENSE AND WARRANTY

Corporate Headquarters

Cisco Systems, Inc.
170 West Tasman Drive
San Jose, CA 95134-1706
USA
<http://www.cisco.com>
Tel: 408 526-4000
800 553-NETS (6387)
Fax: 408 526-4100



Common Phone Tasks

View online help on the phone	Press  and choose Help .
Place a call	Go off-hook before or after dialing a number.
Redial a number	Press Redial .
Talk using the handset and listen on the speaker	(Group Listen mode only.) Press GListen .
Listen on the speaker only	(Monitor mode only.) Press Monitor .
Use your call logs	Press  and select Directories > Missed Calls, Placed Calls, or Received Calls . Select a number and press Dial .
Edit a number	Press EditDial , << or >>.
Hold/resume a call	Highlight a call to put on hold or resume from hold, and press  .
Transfer a call to a new number	Press Transfer , enter the number, then press Transfer again.
Start a standard (ad hoc) conference call	Press more > Confrn and dial the participant, then press Confrn again.



Cisco, Cisco IOS, Cisco Systems, and the Cisco Systems logo are registered trademarks of Cisco Systems, Inc. or its affiliates in the United States and certain other countries. All other brands, names, or trademarks mentioned in this document or Website are the property of their respective owners. The use of the word partner does not imply a partnership relationship between Cisco and any other company. (0501R)

© 2006 Cisco Systems, Inc. All rights reserved.

OL-11414-01



Cisco Unified IP Phone 7906G and 7911G for Cisco Unified CallManager 5.1 (SCCP and SIP)

Softkey Definitions

Phone Screen Icons

Button Icons

Speed Dialing

Common Phone Tasks







Softkey Definitions

AbbrDial	Dial using a speed-dial index number
Answer	Answer a call
Barge	Add yourself to a call on a shared line
CallBack	Receive notification when a busy extension becomes available
Cancel	Cancel an action or exit a screen without applying changes
cBarge	Add yourself to a call on a shared line and establish a conference
CFwdALL	Setup/cancel call forwarding
Clear	Delete records or settings
Close	Close the current window
ConfList	View conference participants
Confrn	Create a conference call
Delete	Remove characters to the right of the cursor when using EditDial
Details	Opens the Details call record for a multiparty call in the Missed Calls and Received Calls logs
Dial	Dial a phone number
DirTrfr	Transfer two calls to each other
DND	Turn off Do Not Disturb (DND)
EditDial	Edit a number in a call log
EndCall	Disconnect the current call
Erase	Reset settings to their defaults
Exit	Return to the previous screen
GListen	Talk using the handset and listen on the speaker (Group Listen)
GLOff	Disable Group Listen



GPickUp	Answer a call ringing in another group
iDivert	Send a call to a voice messaging system
Join	Join several calls on a single line to create a conference
MeetMe	Host a Meet-Me conference call
Monitor	Listen to a call on the speaker
MonOff	Disable the Monitor function
more	Display additional softkeys
Msgs	Access voice mail system
NewCall	Make a new call
OPickUp	Answer a call ringing in an associated group
Park	Store a call using Call Park
PickUp	Answer a call in your group
QRT	Submit call problems to the system administrator
Redial	Redial the most recently dialed number
Remove	Remove a conference participant
RmLstC	Drop the last party added to a conference call
Search	Search for a directory listing
Transfer	Transfer a call
Update	Refresh content
VidMode	Choose a video display mode
<<	Delete entered characters
>>	Move through entered characters

Phone Screen Icons



Call State

	Call Forwarding enabled
	Call on hold
	Connected call
	Off-hook
	On-hook
	Incoming call
	Shared line in use





Secure Calls

	Authenticated call
	Encrypted call

Selected Device





	Handset in use
	Speaker in use (Monitor on)

Critical Calls





	Priority call
	Medium priority call
	High priority call
	Highest priority call

Other Features



	Speed Dial configured
---	-----------------------

	Message waiting
	Option selected
	Feature enabled
	Video enabled (Cisco Unified IP Phone 7911G only)
	URL entry in call log is ready to edit

Button Icons

	Volume
	Navigation
	Hold
	Applications Menu

Speed Dialing

If you want to...	Then...
Speed dial a number	<ul style="list-style-type: none"> Press  and select a number to dial. Press  and choose Directories > Speed Dials. Select a number to dial. Enter a speed-dial number while on-hook and press AbbrDial.



Contents

Getting Started 1

- Using this Guide 1
- Finding Additional Information 2
- Safety and Performance Information 2
- Accessibility Features 4

Connecting Your Phone 5

An Overview of Your Phone 9

- Understanding Buttons and Hardware 9
- Understanding Applications Menus 11
- Understanding the Help System on Your Phone 11
- Understanding Lines vs. Calls 11
 - Understanding Line and Call Icons 12
- Understanding Feature Availability 12
- Understanding SIP vs. SCCP 12

Basic Call Handling 13

- Placing a Call—Basic Options 13
- Placing a Call—Additional Options 14
- Answering a Call 15
- Ending a Call 16
- Using Hold and Resume 16
- Switching Between Multiple Calls 16
- Viewing Multiple Calls 17
- Transferring Calls 17
- Sending a Call to a Voice Messaging System 18

- Forwarding All Calls to Another Number 19
- Using Do Not Disturb 20
- Making Conference Calls 20
 - Understanding Types of Conference Calls 20
 - Starting and Joining a Standard Conference 21
 - Starting or Joining a Meet-Me Conference Call 23

Advanced Call Handling 24

- Speed Dialing 24
- Picking Up a Redirected Call on Your Phone 25
- Using a Shared Line 26
 - Understanding Shared Lines 26
 - Adding Yourself to a Shared-Line Call 26
 - Preventing Others from Viewing or Barging a Shared-Line Call 27
- Storing and Retrieving Parked Calls 28
- Making and Receiving Secure Calls 28
- Tracing Suspicious Calls 29
- Prioritizing Critical Calls 30
- Using Cisco Extension Mobility 31

Using a Handset, Headset, and Speaker 32

- Using the Group Listen Feature 32
- Using the Monitor Feature 33
- Using and Obtaining a Headset 33
- Using AutoAnswer 34

Using Phone Settings 35

- Customizing Rings and Message Indicators 35
- Customizing the Phone Screen 36

Using Call Logs and Directories 37

- Using Call Logs 37
- Directory Dialing 39
 - Using Corporate Directory on Your Phone 40

Using Personal Directory on Your Phone 41

Accessing Voice Messages 44

Customizing Your Phone on the Web 45

Accessing Your User Options Web Pages 45

Configuring Features and Services on the Web 46

Using Personal Directory on the Web 46

Using Your Personal Address Book on the Web 46

Configuring Fast Dials on the Web 47

Using the Address Book Synchronization Tool 48

Setting Up Speed Dials on the Web 48

Setting Up Phone Services on the Web 49

Controlling User Settings on the Web 50

Controlling Line Settings on the Web 51

Using Cisco WebDialer 52

Understanding Additional Configuration Options 55

Troubleshooting Your Phone 57

General Troubleshooting 57

Viewing Phone Administration Data 58

Using the Quality Reporting Tool 58

Cisco One-Year Limited Hardware Warranty Terms 59

Index 61



Getting Started

Using this Guide

This guide provides you with an overview of the features available on your phone. You can read it completely for a solid understanding of your phone's capabilities, or refer to the table below for pointers to commonly-used sections.

If you want to...	Then...
Explore your phone on your own	Press  and choose Help .
Review safety information	See Safety and Performance Information, page 2 .
Connect your phone	See Connecting Your Phone, page 5 .
Use your phone after it is installed	Start with An Overview of Your Phone, page 9 .
Learn about the phone buttons	See Understanding Buttons and Hardware, page 9 .
Make calls	See Placing a Call—Basic Options, page 13 .
Put calls on hold	See Using Hold and Resume, page 16 .
Transfer calls	See Transferring Calls, page 17 .
Make conference calls	See Making Conference Calls, page 20 .
Set up speed dialing	See Speed Dialing, page 24 .
Share a phone number	See Using a Shared Line, page 26 .
Use the speaker on the phone	See Using a Handset, Headset, and Speaker, page 32 .
Change the ring volume or tone	See Using Phone Settings, page 35 .
View your missed calls	See Using Call Logs and Directories, page 37 .
Listen to your voice messages	See Accessing Voice Messages, page 44 .
See softkey and icon definitions	Refer to the Quick Reference Card in the front of this guide.

Finding Additional Information

You can access the most current Cisco documentation on the World Wide Web at this URL:

<http://www.cisco.com/univercd/home/home.htm>

You can access the Cisco website at this URL:

<http://www.cisco.com/>

International Cisco websites can be accessed from this URL:

http://www.cisco.com/public/countries_languages.shtml

Safety and Performance Information

Read the following safety notices before installing or using your Cisco Unified IP Phone:



Warning

IMPORTANT SAFETY INSTRUCTIONS

This warning symbol means danger. You are in a situation that could cause bodily injury. Before you work on any equipment, be aware of the hazards involved with electrical circuitry and be familiar with standard practices for preventing accidents. Use the statement number provided at the end of each warning to locate its translation in the translated safety warnings that accompanied this device. Statement 1071

SAVE THESE INSTRUCTIONS



Warning

Read the installation instructions before you connect the system to its power source.



Warning

Ultimate disposal of this product should be handled according to all national laws and regulations.



Warning

Do not work on the system or connect or disconnect cables during periods of lightning activity.

**Warning**

To avoid electric shock, do not connect safety extra low voltage (SELV) circuits to telephone network voltage (TNV) circuits. LAN ports contain SELV circuits, and WAN ports contain TNV circuits. Some LAN and WAN ports use RJ-45 connectors. Use caution when connecting cables.

**Caution**

Inline power circuits provide current through the communication cable. Use the Cisco provided cable or a minimum 24 AWG communication cable.

Using an External Power Supply

The following warnings apply when you use the external power supply with the Cisco Unified IP Phone:

**Warning**

This product relies on the building's installation for short-circuit (over current) protection. Ensure that a fuse or circuit breaker no larger than 120 VAC, 15A U.S. (240 VAC, 10A international) is used on the phase conductors (all current-carrying conductors).

**Warning**

The device is designed to work with TN power systems.

**Warning**

The plug-socket combination must be accessible at all times because it serves as the main disconnecting device.

**Warning**

The power supply must be placed indoors.

**Caution**

Use only a Cisco specified power supply with this product.

Power Outage

Your accessibility to emergency service through the phone is dependent on the phone being powered. If there is an interruption in the power supply, Service and Emergency Calling Service dialing will not function until power is restored. In the case of a power failure or disruption, you may need to reset or reconfigure equipment before using the Service or Emergency Calling Service dialing.

Using External Devices

The following information applies when you use external devices with the Cisco Unified IP Phone:

Cisco recommends the use of good quality external devices (headsets) that are shielded against unwanted radio frequency (RF) and audio frequency (AF) signals.

Depending on the quality of these devices and their proximity to other devices such as mobile phones or two-way radios, some audio noise may still occur. In these cases, Cisco recommends that you take one or more of the following actions:

- Move the external device away from the source of the RF or AF signals.
- Route the external device cables away from the source of the RF or AF signals.
- Use shielded cables for the external device, or use cables with a better shield and connector.
- Shorten the length of the external device cable.
- Apply ferrites or other such devices on the cables for the external device.

Cisco cannot guarantee the performance of the system because Cisco has no control over the quality of external devices, cables, and connectors. The system will perform adequately when suitable devices are attached using good quality cables and connectors.



Caution

In European Union countries, use only headsets that are fully compliant with the EMC Directive [89/336/EC].

Accessibility Features

A list of accessibility features is available upon request.

Connecting Your Phone

Your system administrator will likely connect your new Cisco Unified IP Phone to the corporate IP telephony network. If that is not the case, refer to the graphics below to connect your phone.

The following graphic and table show how to connect the Cisco Unified IP Phone 7906G:

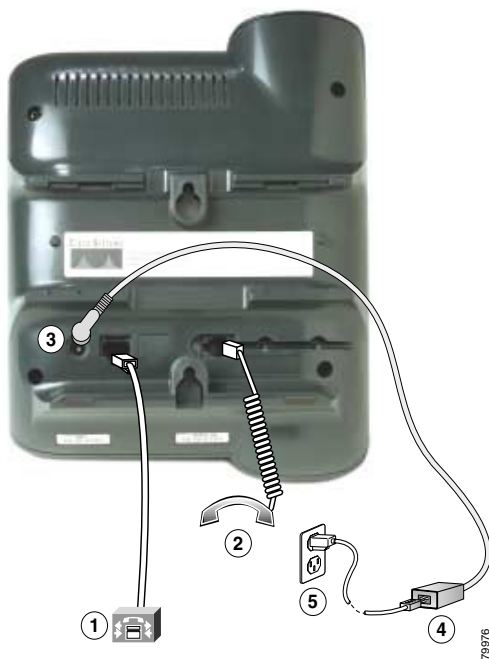

1	Network port (10/100 SW)	4	AC-to-DC power supply
2	Handset port	5	AC power cord
3	DC adapter port (DC48V)		

The following graphic and table show how to connect the Cisco Unified IP Phone 7911G:

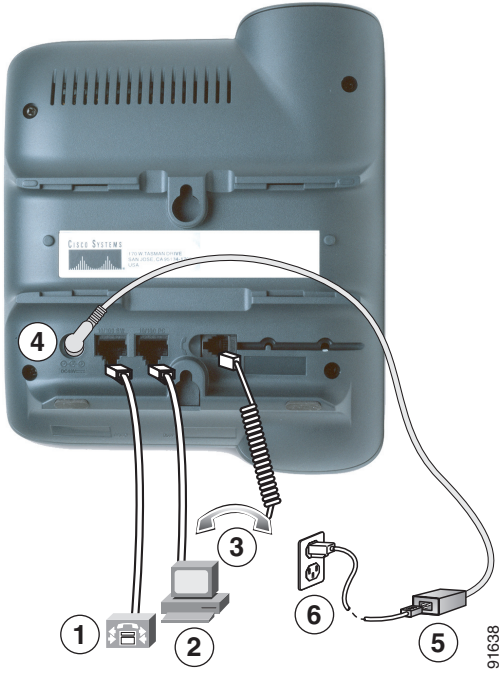

1	Network port (10/100 SW)	4	DC adapter port (DC48V)
2	Access port (10/100 PC)	5	AC-to-DC power supply
3	Handset port	6	AC power cord

Adjusting the Handset Rest

When you connect your phone, you might want to adjust the handset rest to ensure that the receiver will not slip out of the cradle. See the table below for instructions.

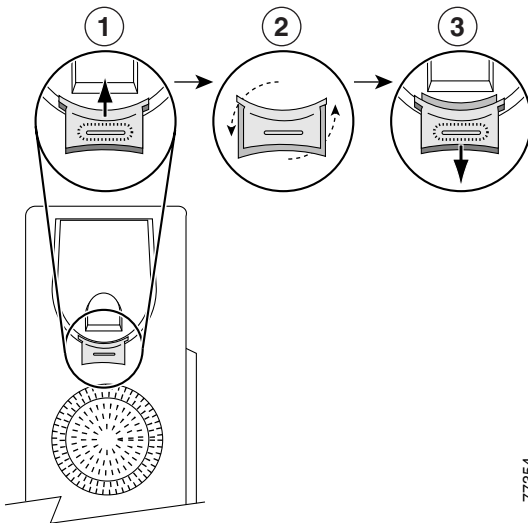

77354

1	Set the handset aside and pull the square plastic tab from the handset rest.
2	Rotate the tab 180 degrees.
3	Slide the tab back into the handset rest. An extension protrudes from the top of the rotated tab. Return the handset to the handset rest.

Registering with TAPS

After your phone is connected to the network, your system administrator might ask you to auto-register your phone using the Tool for Auto-Registered Phones Support (TAPS). TAPS might be used either for a new phone or to replace an existing phone.

To register with TAPS, pick up the handset, enter the TAPS extension provided by your system administrator, and follow the voice prompts. You might need to enter your entire extension, including the area code. After your phone displays a confirmation message, hang up. The phone will restart.

Headset Information

To use a headset, make sure the handset is disconnected, then connect the headset to the Handset port on the back of your phone.

Depending on headset manufacturer's recommendations, an external amplifier may be required. Refer to headset manufacturer's product documentation for more information.

Although Cisco Systems performs some internal testing of third-party headsets for use with the Cisco Unified IP Phones, Cisco does not certify or support products from headset or handset vendors. Because of the inherent environmental and hardware inconsistencies in the locations where Cisco Unified IP Phones are deployed, there is not a single “best” solution that is optimal for all environments. Cisco recommends that customers test the headsets that work best in their environment before deploying a large number of units in their network.

In some instances, the mechanics or electronics of various headsets can cause remote parties to hear an echo of their own voice when they speak to Cisco Unified IP Phone users.

Cisco Systems recommends the use of good quality external devices (headsets) that are screened against unwanted radio frequency (RF) and audio frequency (AF) signals. Depending on the quality of these devices and their proximity to other devices such as cell phones and two-way radios, some audio noise may still occur. See [Using External Devices, page 4](#) for more information.

The primary reason that support of a headset would be inappropriate for the Cisco Unified IP Phone is the potential for an audible hum. This hum can either be heard by the remote party or by both the remote party and you, the Cisco Unified IP Phone user. Some potential humming or buzzing sounds can be caused by a range of outside sources, for example, electric lights, being near electric motors, large PC monitors. In some cases, a hum experienced by a user may be reduced or eliminated by using a local power cube or power injector. See [Using an External Power Supply, page 3](#) for more information.

Audio Quality Subjective to the User

Beyond the physical, mechanical and technical performance, the audio portion of a headset must sound good to you (the user) and to the party on the far end. Sound is subjective and Cisco cannot guarantee the performance of any headsets or handsets, but some of the headsets and handsets on the sites listed below have been reported to perform well with Cisco Unified IP Phones.

Nevertheless, it is ultimately still the customer’s responsibility to test this equipment in their own environment to determine suitable performance.

For information about headsets, see:

<http://www.vxicorp.com/cisco>

<http://www.plantronics.com/cisco>

An Overview of Your Phone

Cisco Unified IP Phone 7906G and 7911G are full-feature telephones that provide voice communication over the same data network that your computer uses, allowing you to place and receive calls, put calls on hold, transfer calls, make conference calls, and so on.

In addition to basic call-handling features, your Cisco Unified IP Phone 7906G and 7911G can provide specialized or advanced telephony features that extend your call-handling capabilities. Depending on configuration, your phone supports:





- Access to network data, XML applications, and web-based services.
- Online customizing of phone features and services from your User Options web pages.

Understanding Buttons and Hardware

You can use this figure below to identify the buttons and hardware on your phone.







91031

	Item	Description	For more information, see...
1	Phone screen	Displays phone menus and call activity including caller ID, call duration, and call state.	Understanding Applications Menus, page 11 and Understanding Line and Call Icons, page 12.
2	Cisco Unified IP Phone series	Indicates your Cisco Unified IP Phone model series.	—
3	Softkey buttons	Each activates a softkey option displayed on your phone screen.	Softkey Definitions, page 3.
4	Navigation button 	Allows you to scroll through menu items and highlight items. When the phone is on-hook, displays your Speed Dials.	Understanding Applications Menus, page 11 and Speed Dialing, page 24.
5	Applications Menu button 	Displays the Applications menu that provides access to a voice messaging system, phone logs and directories, settings, services, and help.	Understanding Applications Menus, page 11.
6	Hold button 	Places the active call on hold, resumes a call on hold, and switches between an active call and a call on hold.	Using Hold and Resume, page 16.
7	Keypad	Allows you to dial phone numbers, enter letters, and choose menu items.	Basic Call Handling, page 13.
8	Volume button 	Controls the handset, headset, speaker, and ringer volume.	Using a Handset, Headset, and Speaker, page 32.
9	Handset with light strip	The light strip on the handset indicates an incoming call or new voice message.	Accessing Voice Messages, page 44.
10	Footstand	Allows the phone to stand at a convenient angle on a desk or table.	—





Understanding Applications Menus

Use the Applications menus to access phone features.

If you want to...	Then...
Access the Applications menus	Press  to display a list of Applications: Messages, Directory, Settings, Services, and Help.
Scroll through a list or menu	Press  .
Select a menu item	Press  to highlight a menu item, then press Select . You can also press the number on the keypad that corresponds to the number for the menu item.
Go back one level in a menu	Press Exit . (Note that if you press Exit from the top-level of a menu, the menu will close.)
Close a menu (and return to the Applications menu)	Press Exit one or more times until the menu closes, or press  .
Exit the Applications menu	Press  or Exit .



Note

After you press , the LED turns green and stays lit while you are using the Applications menus. If you depart from an application without pressing  or **Exit** (for example, to answer a new call), the phone screen display may change but the  button stays green. If you press  again, the application that you were using resumes at the point when it was interrupted.

Understanding the Help System on Your Phone

The Cisco Unified IP Phone 7906G and 7911G provide a comprehensive online help system. To view the phone help, press  and choose **Help**.









Understanding Lines vs. Calls

To avoid confusion about lines and calls, refer to these descriptions:

- **Lines**—Each line corresponds to a phone number (or extension) that others can use to call you. Your phone can support one line.
- **Calls**—Each line can support multiple calls. By default, your phone supports up to six connected calls, but your system administrator can adjust this number according to your needs. Only one call can be active at any time; other calls are automatically placed on hold.

Understanding Line and Call Icons

Your phone displays icons to help you determine the call and line state (on-hook, on hold, ringing, connected, and so on).

Icon	Call or line state	Description
	On-hook line	No call activity on this line.
	Off-hook line	You are dialing a number or an outgoing call is ringing.
	Connected call	You are connected to the other party.
	Ringing call	A call is ringing on your line.
	Call on hold	You have put this call on hold. See Using Hold and Resume, page 16 .
	Remote-in-use	Another phone that shares your line has a connected call. See Understanding Shared Lines, page 26 .
	Authenticated call	See Making and Receiving Secure Calls, page 28 .
	Encrypted call	See Making and Receiving Secure Calls, page 28 .

Understanding Feature Availability

Depending on your phone system configuration, features included in this Phone Guide might not be available to you or might work differently on your phone. Contact your support desk or system administrator for information about feature operation or availability.

Understanding SIP vs. SCCP

Your phone can be configured to work with one of two signaling protocols: SIP (Session Initiation Protocol) or SCCP (Skinny Call Control Protocol). Your system administrator determines this configuration.

Phone features can vary depending on the protocol. This Phone Guide indicates which features are protocol-specific. To learn which protocol your phone is using, you can ask your system administrator or you can choose  > **Model Information** > **Call Control Protocol** on your phone.

Basic Call Handling

You can perform basic call-handling tasks using a range of features and services. Feature availability can vary; see your system administrator for more information.

Placing a Call—Basic Options

Here are some easy ways to place a call on your Cisco Unified IP Phone.





If you want to...	Then...	For more information, see...
Place a call	Pick up the handset and dial the number.	An Overview of Your Phone, page 9.
Dial on-hook (with dial tone)	Press NewCall and dial the number.	—
Redial a number	Press Redial .	—
Place a call when another call is active	<ol style="list-style-type: none"> 1. Press Hold. 2. Press New Call. 3. Enter a number. 	Using Hold and Resume, page 16.
Dial from a call log	<ol style="list-style-type: none"> 1. Press Call Log and select Directories > Missed Calls, Received Calls, or Placed Calls. 2. Scroll to the number and press Dial. 	Using Call Logs, page 37.

Tips

- You can dial on-hook without a dial tone (pre-dial). To pre-dial, enter a number, then go off-hook by lifting the handset and press **Dial**.
- When you pre-dial, your phone tries to anticipate the number you are dialing by displaying matching numbers (if available) from your Placed Calls log. This is called Auto Dial. To call a number displayed with Auto Dial, scroll to it, press **Dial**, and go off-hook.
- If you make a mistake while dialing, press << to erase digits.

Placing a Call—Additional Options

You can place calls using special features and services that might be available on your phone. See your system administrator for more information about these additional options.

If you want to...	Then...	For more information, see...
Speed dial a number	Do one of the following: <ul style="list-style-type: none"> • Press , choose a speed-dial number, and press Dial. • Press  and select Directories > Speed Dials. Select a number and press Dial. • Use the Abbreviated Dial feature. • Use the Fast Dial feature. 	Speed Dialing, page 24.
Dial from a corporate directory on your phone	<ol style="list-style-type: none"> 1. Press  and select Directories > Corporate Directory (name can vary). 2. Enter a name and press Search. 3. Highlight a listing and go off-hook. 	Using Call Logs, page 37.
Dial from a corporate directory on your personal computer using Cisco WebDialer	<ol style="list-style-type: none"> 1. Open a web browser and go to a WebDialer-enabled corporate directory. 2. Click the number that you want to dial. 	Using Cisco WebDialer, page 52.
Use Cisco CallBack to receive notification when a busy or ringing extension is available	<ol style="list-style-type: none"> 1. Press CallBack while listening to the busy tone or ring sound. 2. Hang up. Your phone alerts you when the line is free. 3. Place the call again. 	Your system administrator.
Make a priority (precedence) call (SCCP phones only)	Enter the Multilevel Precedence and Preemption (MLPP) access number, then enter a phone number.	Prioritizing Critical Calls, page 30.
Dial from a Personal Address Book (PAB) entry	<ol style="list-style-type: none"> 1. Press  and select Directories > Personal Directory to log in. 2. Choose Personal Address Book and search for a listing. 	Using Personal Directory on Your Phone, page 41.

If you want to...	Then...	For more information, see...
Place a call using a billing or tracking code (SCCP phones only)	<ol style="list-style-type: none"> 1. Dial a number. 2. After the tone, enter a client matter code (CMC) or a forced authorization code (FAC). 	Your system administrator.
Place a call using your Cisco Extension Mobility profile	Log in to the Extension Mobility service on a phone.	Using Cisco Extension Mobility, page 31.

Answering a Call

You can answer a call by simply lifting the handset, or you can use other options if they are available on your phone.

If you want to...	Then...	For more information, see...
Switch from a connected call to answer a new call	Press Answer .	Using Hold and Resume, page 16.
Answer a call using call waiting	Press Answer .	Using Hold and Resume, page 16.
Send a call to a voice messaging system	Press iDivert .	Sending a Call to a Voice Messaging System, page 18
Auto-connect calls	Use AutoAnswer.	Using AutoAnswer, page 34.
Retrieve a parked call on another phone	Use Call Park.	Storing and Retrieving Parked Calls, page 28.
Use your phone to answer a call that is ringing elsewhere	Use Call Pickup.	Picking Up a Redirected Call on Your Phone, page 25.
Answer a priority call (SCCP phones only)	Hang up the current call and press Answer .	Prioritizing Critical Calls, page 30.



Ending a Call

To end a call, simply hang up. Here are some more details.



If you want to...	Then...
Hang up while using the handset	Return the handset to its cradle. Or press EndCall .
Hang up while monitoring a call (using the speaker)	Press EndCall .
Hang up one call, but preserve another call on the same line	Press EndCall . If necessary, remove the call from hold first.

Using Hold and Resume

Only one call can be active at any given time; all other connected calls must be placed on hold.

If you want to...	Then...
Put a call on hold	<ol style="list-style-type: none">1. Make sure the call you want to put on hold is highlighted.2. Press .
Remove a call from hold	<ol style="list-style-type: none">1. Make sure the appropriate call is highlighted.2. Press .

Tips

- Engaging the Hold feature typically generates music or a beeping tone.
- A held call is indicated by the call-on-hold icon: . When a held call is highlighted, the Hold button  becomes lit (red). When a call that is not held is highlighted, and there are other held calls on the line, the Hold button changes to blinking (red).

Switching Between Multiple Calls

You can switch between multiple calls on your phone.

If you want to...	Then...
Switch between connected calls	<ol style="list-style-type: none">1. Make sure the call that you want to switch to is highlighted.2. Press . Any active call is placed on hold and the selected call is resumed.
Switch from a connected call to answer a ringing call	Press Answer . Any active call is placed on hold.

Viewing Multiple Calls

Understanding how multiple calls are displayed on your phone can help you organize your call-handling efforts.

Your phone displays calls as follows for the highlighted line:

- Calls with the highest precedence and longest duration display at the top of the list.
- Calls of a similar type are grouped together. For example, calls that you have interacted with are grouped near the top, and calls on hold are grouped last.

Transferring Calls

Transfer redirects a connected call. The *target* is the number to which you want to transfer the call.

If you want to...	Then...
Transfer a call without talking to the transfer recipient	<ol style="list-style-type: none"> 1. From an active call, press Transfer. 2. Enter the target number. 3. Press Transfer again to complete the transfer or EndCall to cancel. <p>Note If your phone supports on-hook transfer, you can alternately complete the transfer by hanging up.</p>
Talk to the transfer recipient before transferring a call (consult transfer)	<ol style="list-style-type: none"> 1. From an active call, press Transfer. 2. Enter the target number. 3. Wait for the transfer recipient to answer. 4. Press Transfer again to complete the transfer or EndCall to cancel. <p>Note If your phone supports on-hook transfer, you can alternately complete the transfer by hanging up.</p>
Transfer two current calls to each other (direct transfer) without staying on the line (SCCP phones only)	<ol style="list-style-type: none"> 1. Scroll to highlight any call on the line. 2. Press Select. 3. Repeat this process for the second call. 4. With one of the selected calls highlighted, press DirTrfr. (To display DirTrfr, you might need to press more.) <p>The two calls connect to each other and drop you from the call.</p> <p>Note If you want to stay on the line with the callers, use Join instead.</p>
Redirect a call to a voice messaging system	Press iDivert . For more information, see Sending a Call to a Voice Messaging System, page 18 .

Tips

- If on-hook transfer is enabled on your phone, you can either hang up to complete the call, or press **Transfer** and then hang up.
- If on-hook transfer is *not* enabled on your phone, hanging up without pressing **Transfer** again places the call on hold.
- You cannot use **Transfer** to redirect a call on hold. Press  again to remove the call from hold before transferring it.

Sending a Call to a Voice Messaging System

You can use **iDivert** to send an active, ringing, or on-hold call to your voice messaging system. Depending on the type of call and your phone configuration, you can also use **iDivert** to send the call to another party's voice messaging system.

- If the call was originally sent to someone else's phone, **iDivert** allows you to redirect the call either to your own voice messaging system or to the original called party's voice messaging system. Your system administrator must make this option available to you.
- If the call was sent to you directly (not transferred or forwarded to you), or if your phone does not support the option described above, using **iDivert** redirects the call to your voice messaging system.



If you want to...	Then...
Send an active, ringing, or on-hold call to a voice messaging system	Press iDivert . One of two things occurs: <ul style="list-style-type: none">• The call is transferred to your voice messaging system.• Your phone screen displays a menu that allows you to choose between your voice messaging system or the voice messaging system of the original called party. Choose an option to redirect the call.

Tip

If your phone displays a menu that disappears before you make your selection, you can press **iDivert** again to re-display the menu. You can also ask your system administrator to configure a longer timeout value.

Forwarding All Calls to Another Number

You can use Call Forward All to redirect incoming calls from your phone to another number.

If you want to...	Then...
Set up call forwarding on your line	Press CFwdALL and enter a target phone number.
Cancel call forwarding on your line	Press CFwdALL .
Verify that call forwarding is enabled on your line	Look for: <ul style="list-style-type: none"> • Alternating call forwarding icons   displayed next to your phone number. • The call forward target number in the status line.
Set up or cancel call forwarding remotely	<ol style="list-style-type: none"> 1. Log in to your User Options web pages. (See Accessing Your User Options Web Pages, page 45.) 2. Access your call forwarding settings. (See Controlling Line Settings on the Web, page 51.)



Tips

- Enter the call forward target number exactly as you would dial it from your phone. For example, enter an access code or the area code, if necessary.
- You can forward your calls to a traditional analog phone or to another IP phone, although your system administrator might restrict the call forwarding feature to numbers within your company.
- Call forwarding is phone line specific. If a call reaches you on a line where call forwarding is not enabled, the call will ring as usual.
- Your system administrator can enable a call forward override feature that allows the person receiving your forwarded calls to reach you. With override enabled, a call placed from the target phone to your phone is not forwarded, but rings through.
- Your system administrator can change call forwarding conditions for your phone line.

Using Do Not Disturb

(SIP phones only.)

You can use the Do Not Disturb (DND) feature to block incoming calls on your phone with a busy tone.

If you want to...	Then...
Turn on DND	<ol style="list-style-type: none">1. Press  > Device Configuration > Call Preferences > Do Not Disturb.2. Select Yes, and then press Save. <p>“Do Not Disturb” displays on the status line, and a DND softkey is added.</p>
Turn off DND	Press the DND softkey or: <ol style="list-style-type: none">1. Press  > Device Configuration > Call Preferences > Do Not Disturb.2. Select No, and then press Save.

Tips

- When DND is turned on:
 - The DND blocking feature applies to all the lines on your phone.
 - Received calls are not logged to the Missed Calls directory on your phone.
- When DND and Call Forward All are both enabled on your phone, Call Forward All takes precedence on incoming calls. That is, calls will be forwarded and the caller will not hear a busy tone.
- If DND is not enabled on your phone, see your system administrator.

Making Conference Calls

Your Cisco Unified IP Phone allows you to join three or more people into one telephone conversation, creating a conference call.

Understanding Types of Conference Calls

There are two types of conference calls: Standard (ad hoc) and Meet-Me.

Standard Conference Calls

You can create a standard conference in different ways, depending on your needs and the softkeys available on your phone:

- **Confrn**—Use this softkey to establish a standard conference by calling each participant. Standard conference calling is a default feature available on most phones.
- **Join**—Use this softkey to establish a standard conference by joining several calls already in progress on one line. (SCCP phones only.)
- **cBarge**—Use this softkey to add yourself to an existing call on a shared line and to turn the call into a standard conference call. This feature is available only on phones that use shared lines.

See [Starting and Joining a Standard Conference, page 21](#) for additional instructions.

Meet-Me Conference Calls

You can create a Meet-Me conference by calling the Meet-Me phone number at a specified time.

See [Starting or Joining a Meet-Me Conference Call, page 23](#) for additional instructions.

Starting and Joining a Standard Conference

A standard (ad hoc) conference allows at least three participants to talk on a single call.

If you want to...	Then...
<ul style="list-style-type: none"> • Create a conference by calling participants • Add new participants to an existing conference 	<ol style="list-style-type: none"> 1. From a connected call, press Confrn. (You may need to press the more softkey to see Confrn.) 2. Enter the participant's phone number. 3. Wait for the call to connect. 4. Press Confrn again to add the participant to your call. 5. Repeat to add additional participants.
Create a conference by joining two or more existing calls (SCCP phones only)	<ol style="list-style-type: none"> 1. Make sure that you have two or more calls on a single line. 2. Highlight a call that you want to add to the conference. 3. Press Select. The selected call displays this icon . 4. Repeat this process for each call that you want to add. 5. From one of the selected calls, press Join. (You may need to press the more softkey to see Join.) <p>Note The active call is automatically selected.</p>
Participate in a conference	Answer the phone when it rings.

If you want to...	Then...
Create a conference by barging a called on shared line	Highlight a call on a shared line and press cBarge . (You may need to press the more softkey to display cBarge .) See Using a Shared Line, page 26 .
View a list of conference participants	<ol style="list-style-type: none"> 1. Highlight an active conference. 2. Press ConfList. Participants are listed in the order in which they join the conference with the most recent additions at the top.
Get an updated list of participants	While viewing the conference list, press Update .
See who started the conference	While viewing the conference list, locate the person listed at the bottom of the list with an asterisk (*) next to the name.
Drop the last party added to the conference	Press RmLstC . You can remove participants only if you initiated the conference call.
Remove any conference participant	<ol style="list-style-type: none"> 1. Highlight the participant's name. 2. Press Remove. You can remove participants only if you initiated the conference.
End your participation in a conference	Hang up or press EndCall .

Tips

- Calls must be on the same line before you can add them to a conference using **Confrn** or **Join**. (Join is available on SCCP phones only.)
- Depending on how your phone is configured, if you leave a conference after creating it, the conference might end. To avoid this, transfer the conference before hanging up.

Starting or Joining a Meet-Me Conference Call

Meet-Me conferencing allows you to start or join a conference by dialing the conference number.

If you want to...	Then...
Start a Meet-Me conference	<ol style="list-style-type: none"> 1. Obtain a Meet-Me phone number from your system administrator. 2. Distribute the number to participants. 3. When you are ready to start the meeting, go off-hook to invoke a dial tone, then press MeetMe. 4. Dial the Meet-Me conference number. Participants can now join the conference by dialing in. <p>Note Participants hear a busy tone if they call the conference before the initiator has joined. In this case, participants must call back.</p>
Participate in a Meet-Me conference	<p>Dial the Meet-Me conference number (provided by the conference initiator).</p> <p>Note You will hear a busy tone if you call the conference before the initiator has joined. In this case, try your call again.</p>
End a Meet-Me conference	<p>All participants must hang up. The conference does not automatically end when the conference initiator disconnects.</p>

Advanced Call Handling

Advanced call-handling tasks involve special features that your system administrator might configure for your phone depending on your call-handling needs and work environment.

Speed Dialing



Speed dialing allows you to enter an index number or select a phone screen item to place a call. Depending on configuration, your phone can support several speed-dial features:

- Speed Dials
- Abbreviated Dialing
- Fast Dials



Note

- To set up speed-dial numbers and Abbreviated Dial, you must be able to access your User Options web pages. See [Customizing Your Phone on the Web, page 45](#).
- To set up Fast Dials, you must have access to the Personal Directory feature. See [Using Personal Directory on Your Phone, page 41](#).
- Alternately, your system administrator can configure speed-dial features for you.

If you want to...	Then...
Use Speed Dials	<ol style="list-style-type: none">1. Set up speed-dial numbers. See Setting Up Speed Dials on the Web, page 48.2. To place a call, press , or press  and select Directories > Speed Dials.
Use Abbreviated Dial	<ol style="list-style-type: none">1. Set up Abbreviated Dialing codes. See Setting Up Speed Dials on the Web, page 48.2. To place a call, enter the Abbreviated Dialing code and press AbbrDial.
Use Fast Dial	<ol style="list-style-type: none">1. Create a Personal Address Book entry and assign a Fast Dial code. See Using Personal Directory on the Web, page 46.2. To place a call, access the Fast Dial service on your phone. See Using Personal Directory on Your Phone, page 41.

Picking Up a Redirected Call on Your Phone

Call PickUp allows you to answer a call that is ringing on a co-worker's phone by redirecting the call to your phone. You might use Call PickUp if you share call-handling with coworkers.

If you want to...	Then...
Answer a call that is ringing on another extension within your call pickup group	<ol style="list-style-type: none"> 1. Do one of the following: <ul style="list-style-type: none"> • If the PickUp softkey is available, press it. • If the PickUp softkey is not available, go off-hook to display it, then press PickUp. <p>If your phone supports auto-pickup, you are now connected to the call.</p> 2. If the call rings, press Answer to connect to the call.
Answer a call that is ringing on another extension outside of your group	<ol style="list-style-type: none"> 1. Do one of the following: <ul style="list-style-type: none"> • If the GPickUp softkey is available, press it. • If the GPickUp softkey is not available, go off-hook to display it, then press GPickUp. 2. Enter the group pickup code. <p>If your phone supports auto-pickup, you are now connected to the call.</p> 3. If the call rings, press Answer to connect to the call.
Answer a call that is ringing on another extension in your group or in an associated group	<ol style="list-style-type: none"> 1. Do one of the following: <ul style="list-style-type: none"> • If the OPickUp softkey is available, press it. • If the OPickUp softkey is not available, go off-hook to display it, then press OPickUp. <p>If your phone supports auto-pickup, you are now connected to the call.</p> 2. If the call rings, press Answer to connect to the call.

Tips

- Pressing **PickUp** and **GPickUp** connects you to the call that has been ringing for the longest time.
- Pressing **OPickUp** connects you to the call in the pickup group with the highest priority.

Using a Shared Line

Your system administrator might ask you to use a shared line if you:

- Have multiple phones and want one phone number
- Share call-handling tasks with coworkers
- Handle calls on behalf of a manager

Understanding Shared Lines

Remote-in-Use Icon

The remote-in-use icon  appears when another phone that shares your line has a connected call. You can place and receive calls as usual on the shared line, even when the remote-in-use icon appears.

Sharing Call Information and Barging

Phones that share a line each display information about calls that are placed and received on the shared line. This information might include caller ID and call duration. (See [Privacy, page 26](#) for exceptions.)

When call information is visible in this way, you and coworkers who share a line can add yourselves to calls using either **Barge** or **cBarge**. See [Adding Yourself to a Shared-Line Call, page 26](#).

Privacy

If you do not want coworkers who share your line to see information about your calls, enable the Privacy feature. Doing so also prevents coworkers from barging your calls. See [Preventing Others from Viewing or Barging a Shared-Line Call, page 27](#).



Note The maximum number of calls that a shared line supports can vary by phone.

Adding Yourself to a Shared-Line Call

Depending on how your phone is configured, you can add yourself to a call on a shared line using either **Barge** or **cBarge**.

If you want to...	Then...
See if the shared line is in use	Look for the remote-in-use icon  .
Add yourself to a call on a shared line using the Barge softkey	<ol style="list-style-type: none">1. Highlight a remote-in-use call.2. Press Barge. (You may need to press the more softkey to display Barge.) Other parties hear a beep tone announcing your presence.



If you want to...	Then...
Add yourself to a call on a shared line using the cBarge softkey	<ol style="list-style-type: none"> 1. Highlight a remote-in-use call. 2. Press cBarge. (You may need to press the more softkey to display cBarge.) <p>Other parties hear a tone and brief audio interruption, and call information changes on the phone screen.</p>
Add new conference participants to a call that you have barged	<p>Barge the call using cBarge, if available.</p> <p>Unlike Barge, cBarge converts the call into a standard (ad hoc) conference call, allowing you to add new participants. See Making Conference Calls, page 20.</p>
Leave a barged call	<p>Hang up.</p> <p>If you hang up after using Barge, the remaining parties hear a disconnect tone and the original call continues.</p> <p>If you hang up after using cBarge, the call remains a conference call (provided at least three participants remain on the line).</p>

Tips

- If a phone that is using the shared line has Privacy enabled, call information and barge softkeys will not appear on the other phones that share the line.
- You will be disconnected from a call that you have joined using **Barge** if the call is put on hold, transferred, or turned into a conference call.

Preventing Others from Viewing or Barging a Shared-Line Call

If you share a phone line, you can use the Privacy feature to prevent others who share the line from viewing or barging (adding themselves to) your calls.

If you want to...	Then...
Prevent others from viewing or barging calls on a shared line	<ol style="list-style-type: none"> 1. Press more > Private. 2. To verify that Privacy is on, look for the Privacy-enabled icon  next to “Private” on the phone screen.
Allow others to view or barge calls on a shared line	<ol style="list-style-type: none"> 1. Press more > Private. 2. To verify that Privacy is off, look for the Privacy-disabled icon  next to “Private” on the phone screen.

Tips

- If the phone that shares your line has Privacy enabled, you can make and receive calls using the shared line as usual.
- The Privacy feature applies to all shared lines on your phone. Consequently, if you have multiple shared lines and Privacy is enabled, coworkers will not be able to view or barge calls on any of your shared lines.

Storing and Retrieving Parked Calls

You can park a call when you want to store the call so that you or someone else can retrieve it from another phone in the Cisco Unified CallManager system (for example, a phone at a coworker's desk or in a conference room).

If you want to...	Then...
Store an active call using Call Park	<ol style="list-style-type: none">1. During a call, press Park. (You may need to press the more softkey to see Park.)2. Record the call park number displayed on your phone screen.3. Hang up.
Retrieve a parked call	Enter the call park number from any Cisco Unified IP Phone in your network to connect to the call.





Note You have a limited amount of time to retrieve a parked call before it reverts to ringing at the original number. See your system administrator for details.

Making and Receiving Secure Calls

Depending on how your system administrator has configured your phone system, your phone might support making and receiving secure calls.

Your phone is capable of supporting these types of calls:

- *Authenticated* call—The identities of all phones participating in the call have been verified.
- *Encrypted* call—The phone is receiving and transmitting encrypted audio (your conversation) within the Cisco IP network. Encrypted calls are also authenticated.
- *Non-secure* call—At least one of the participating phones or the connection does not support these security features, or the phones cannot be verified.

If you want to...	Then...
Check the security level of a call	Look for a security icon in the top right corner of the call activity area, next to the call duration timer: <ul style="list-style-type: none"> <li data-bbox="561 488 827 532"> Authenticated call <li data-bbox="561 558 783 602"> Encrypted call Neither security icon appears if the call is non-secure.
Determine if secure calls can be made in your company	Contact your system administrator.



Note There are interactions, restrictions, and limitations that affect how security features work on your phone. For more information, ask your system administrator.

Tracing Suspicious Calls

(SCCP phones only.)

If you are receiving suspicious or malicious calls, your system administrator can add the Malicious Call Identification (MCID) feature to your phone. This feature enables you to identify an active call as suspicious, which initiates a series of automated tracking and notification messages.

If you want to...	Then...
Notify your system administrator about a suspicious or harassing call	Press MCID . Your phone plays a tone and displays the message, “MCID successful.”

Prioritizing Critical Calls

(SPPC phones only.)

In some specialized environments, such as military or government offices, you might need to make and receive urgent or critical calls. If you have the need for this specialized call handling, your system administrator can add Multilevel Precedence and Preemption (MLPP) to your phone.

Keep these terms in mind:

- *Precedence* indicates the priority associated with a call.
- *Preemption* is the process of ending an existing, lower priority call while accepting a higher priority call that is sent to your phone.



If you...	Then...
Want to choose a priority (precedence) level for an outgoing call	Contact your system administrator for a list of corresponding precedence numbers for calls.
Want to make a priority (precedence) call	Enter the MLPP access number (provided by your system administrator) followed by the phone number.
Hear a special ring (faster than usual) or special call waiting tone	You are receiving a priority (precedence) call. An MLPP icon on your phone screen indicates the priority level of the call.
Want to view priority level of a call	Look for an MLPP icon on your phone screen: <ul style="list-style-type: none">■ Priority call▣ Medium priority (immediate) call▤ High priority (flash) call▥ Highest priority (flash override) or Executive Override call Higher priority calls are displayed at the top of your call list. If you do not see an MLPP icon, the priority level of the call is normal (routine).
Want to accept a higher-priority call	Answer the call as usual. If necessary, end an active call first.
Hear a continuous tone interrupting your call	You or the other party are receiving a call that must preempt the current call. Hang up immediately to allow the higher priority call to ring through.

Tips

- When you make or receive an MLPP-enabled call, you will hear special ring tones and call waiting tones that differ from the standard tones.
- If you enter an invalid MLPP access number, a verbal announcement will alert you of the error.

Using Cisco Extension Mobility

Cisco Extension Mobility (EM) allows you to temporarily configure a Cisco Unified IP Phone as your own. Once you log in to EM, the phone adopts your user profile, including your phone lines, features, established services, and web-based settings. Your system administrator must configure EM for you.

If you want to...	Then...
Log in to EM	<ol style="list-style-type: none"> 1. Press  and choose Services > EM Service (name can vary). 2. Enter your user ID and PIN (provided by your system administrator). 3. If prompted, select a device profile.
Log out of EM	<ol style="list-style-type: none"> 1. Press  and choose Services > EM Service (name can vary). 2. When prompted to log out, press Yes.

Tips

- EM automatically logs you out after a certain amount of time. This time limit is established by your system administrator.
- Changes that you make to your EM profile (from the User Options web pages) take effect the next time that you log in to EM on a phone.
- Settings that are controlled on the phone only are not maintained in your EM profile.

Using a Handset, Headset, and Speaker

The Cisco Unified IP Phone 7906G and 7911G provide a speaker for hands-free listening. You can use the speaker only to listen to a call. To talk on a call, you must use the handset.

You can use the speaker in one of two ways, depending on how your system administrator enables the phone. Your phone may be enabled for one of the following features, but not both at the same time:

- Group Listen
- Monitor (default)

Using the Group Listen Feature

The following table shows how you can use the Group Listen feature.

If you want to...	Then...
Use the handset	Lift it to go off-hook; replace it to go on-hook.
Talk using the handset and listen on the speaker at the same time (Group Listen)	Press GListen . Note Group Listen must be enabled by your system administrator for the GListen softkey to display.
Turn off Group Listen and use the handset	Press GLOff .
Hang up after using Group Listen	Press EndCall or hang up.
Adjust the volume level for a call	Note When using Group Listen, adjusting the volume only changes the volume for the speaker and not the handset. Press the up or down Volume button during a call or after invoking a dial tone. Press Save to preserve the volume level for future calls.



Note If your system administrator has disabled the speaker on your phone, the **GListen**, **GLOff**, **Monitor**, and **MonOff** softkeys will not be available to you. You must lift the handset to place and monitor calls.

Using the Monitor Feature

The following table shows how you can use the Monitor feature.

If you want to...	Then...
Use the handset	Lift it to go off-hook; replace it to go on-hook.
Listen to the call on the speaker	Press Monitor and then hang up the handset. You will be able to hear the call but you will not be able to talk on the call. Note The Monitor and MonOff softkeys are not available if Group Listen is enabled.
Turn off the speaker and use the handset	Lift the handset, or press MonOff . Note The Monitor and MonOff softkeys are not available if Group Listen is enabled.
Turn off the speaker and hang up	Press EndCall .
Adjust the speaker volume level for a call	Press the up or down Volume button during a call or after invoking a dial tone. Press Save to preserve the volume level for future calls.



Note

If your system administrator has disabled the speaker on your phone, the **GListen**, **GLOff**, **Monitor**, and **MonOff** softkeys will not be available to you. You must lift the handset to place and monitor calls.



Note

Pressing the **Volume** button changes the volume for the handset or speaker, depending on which device is in use. In Group Listen and Monitor modes, the volume adjustment is for the speaker and not the handset.

Using and Obtaining a Headset

To use a headset, disconnect the handset and connect a headset to the Handset port.

For information about purchasing headsets, see [Headset Information, page 7](#). Depending on headset manufacturer's recommendations, an external amplifier may be required. Refer to headset manufacturer's product documentation for more information.

Using AutoAnswer

When AutoAnswer is enabled, your phone answers incoming calls automatically after a few rings. Your system administrator can configure AutoAnswer to use the speaker to answer calls. However, you can only monitor the call using the speaker. To speak to the caller, you must pick up the handset.

Using Phone Settings

You can personalize your Cisco Unified IP Phone by adjusting the ring tone, background image, and other settings.

Customizing Rings and Message Indicators

You can customize how your phone indicates an incoming call and a new voice message. You can also adjust the ringer volume for your phone.

If you want to...	Then...
Change the ring tone	<ol style="list-style-type: none"> 1. Press  and select Settings > User Preferences > Rings. 2. Select a ring tone and press Play to hear a sample. 3. Press Save to set the ring tone, or press Cancel.
Change the ring pattern (flash-only, ring once, beep-only, etc.)	<ol style="list-style-type: none"> 1. Log in to your User Options web pages. (See Accessing Your User Options Web Pages, page 45.) 2. Access your call ring pattern settings. (See Controlling Line Settings on the Web, page 51.) <p>Note Before you can access this setting, your system administrator might need to enable it for you.</p>
Adjust the volume level for the phone ringer	Press the Volume button while the handset is in the cradle. The new ringer volume is saved automatically.
Change the way that the voice message light on your handset works	<ol style="list-style-type: none"> 1. Log in to your User Options web pages. (See Accessing Your User Options Web Pages, page 45.) 2. Access your message indicator settings. (See Controlling Line Settings on the Web, page 51.) <p>Note Typically, the default system policy is to indicate a new voice message by displaying a steady light on the handset light strip.</p>

Customizing the Phone Screen

You can adjust the characteristics of the phone screen.





If you want to...	Then...
Change the background image	<ol style="list-style-type: none"><li data-bbox="396 334 1225 391">1. Press  and choose Settings > User Preferences > Background Images.<li data-bbox="396 402 1225 431">2. Scroll through available images and press Select to choose an image.<li data-bbox="396 443 1225 472">3. Press Preview to see a larger view of the background image.<li data-bbox="396 483 1225 513">4. Press Exit to return to the selection menu.<li data-bbox="396 524 1225 553">5. Press Save to accept the new image, or press Cancel.
Change the language on the phone screen	<ol style="list-style-type: none"><li data-bbox="396 573 1225 630">1. Log in to your User Options web pages. (See Accessing Your User Options Web Pages, page 45.)<li data-bbox="396 641 1225 698">2. Access your user settings. (See Controlling User Settings on the Web, page 50.)
Change the line text label	<ol style="list-style-type: none"><li data-bbox="396 719 1225 776">1. Log in to your User Options web pages. (See Accessing Your User Options Web Pages, page 45.)<li data-bbox="396 787 1225 844">2. Access your line text label settings. (See Controlling Line Settings on the Web, page 51.)





Using Call Logs and Directories

This section describes how you can use call logs and directories. To access both features, press  and select **Directories**.

Using Call Logs

Your phone maintains logs of your missed, placed, and received calls.

If you want to...	Then...
View your call logs	Press  , and choose Directories > Missed Calls, Placed Calls, or Received Calls . Each stores up to 100 records. To view a truncated listing, highlight it and press EditDial .
Display details for a single call record	<ol style="list-style-type: none"> 1. Press , choose Directories > Missed Calls, Placed Calls, or Received Calls. 2. Highlight a call record. 3. Press Details. Doing so displays information such as called number, calling number, time of day, and call duration (for placed and received calls only).
Erase all call records in all logs	Press  , choose Directories , then press Clear .
Erase all call records in a single log	<ol style="list-style-type: none"> 1. Press , choose Directories > Missed Calls, Placed Calls, or Received Calls. 2. Highlight a call record. 3. Press Clear. (You may need to press the more softkey to display Clear.)
Erase a single call record	<ol style="list-style-type: none"> 1. Press , choose Directories > Missed Calls, Placed Calls, or Received Calls. 2. Highlight a call record. 3. Press Delete.

If you want to...	Then...
Dial from a call log (while not on another call)	<ol style="list-style-type: none"> 1. Press  and choose Directories > Missed Calls, Placed Calls, or Received Calls. 2. Highlight a call record from the log. <p>Note If the Details softkey appears, the call is the primary entry of a multiparty call. See the Tip section below.</p> <ol style="list-style-type: none"> 3. If you need to edit the displayed number, press EditDial followed by << or >>. To delete the number, press EditDial followed by Delete. (You may need to press the more softkey to display Delete.) 4. Go off-hook to place the call.
Dial from a call log (while connected to another call)	<ol style="list-style-type: none"> 1. Press , and choose Directories > Missed Calls, Placed Calls, or Received Calls. 2. Highlight a call record from the log. <p>Note If the Details softkey displays, the call is the primary entry of a multiparty call. See the Tip section below.</p> <ol style="list-style-type: none"> 3. If you need to edit the displayed number, press EditDial followed by << or >>. To delete the number, press EditDial followed by Delete. (You may need to press the more softkey to display Delete.) 4. Press Dial. 5. Choose one of the following to handle the original call: <ul style="list-style-type: none"> • Hold—Puts the first call on hold. • Transfer—Transfers the first party to the second and drops you from the call. (Press Transfer again after dialing to complete the action.) • Confrn—Creates a conference call with all parties, including you. (Press Confrn again after dialing to complete the action.) • End Call—Disconnects the first call and dials the second.
Place a call from a URL entry in a call log (SIP phones only)	<ol style="list-style-type: none"> 1. Press , and choose Directories > Missed Calls, Placed Calls, or Received Calls. 2. Highlight the URL entry that you want to dial. 3. If you need to edit the entry, press EditDial. The  icon appears to indicate that you can begin editing characters in the URL entry. 4. Press Dial.

Tip

(SCCP phones only.)

To view the complete call record of a multiparty call, press **Details**. The Details record shows two entries for each missed or received multiparty call. The entries are listed in reverse chronological order:

- The first logged entry is the name/number of the last completed call of a multiparty call received on your phone.
- The second logged entry is the name/number of the first completed call of a multiparty call received on your phone.



Directory Dialing

Depending on configuration, your phone can provide corporate and personal directory features:

- Corporate Directory—A directory of corporate contacts that is set up and maintained by your system administrator.
- Personal Directory—If available, personal contacts and associated speed-dial codes that you can configure and access from your phone and User Options web pages. Personal Directory comprises the Personal Address Book (PAB) and Fast Dials.
 - PAB is a directory of your personal contacts.
 - Fast Dials allows you to assign codes to PAB entries for quick dialing.

Using Corporate Directory on Your Phone

You can use a corporate directory to place calls to coworkers.

If you want to...	Then...
Dial from a corporate directory (while not on another call)	<ol style="list-style-type: none">1. Press , and choose Directories > Corporate Directory (exact name can vary).2. Use your keypad to enter a full or partial name and press Search.3. To dial, select the listing, and go off-hook.
Dial from a corporate directory (while connected to another call)	<ol style="list-style-type: none">1. Press , and choose Directories > Corporate Directory (exact name can vary).2. Use your keypad to enter a full or partial name, and press Search.3. Scroll to a listing and press Dial.4. Choose one of the following to handle the original call:<ul style="list-style-type: none">• Hold—Puts the first call on hold.• Transfer—Transfers the first party to the second and drops you from the call. (Press Transfer again after dialing to complete the action.)• Confrn—Creates a conference call with all parties, including you. (Press Confrn again after dialing to complete the action.)• End Call—Disconnects the first call and dials the second.



Tip

Use the numbers on your keypad to enter characters on your phone screen. Use the Navigation button on your phone to move between input fields.

Using Personal Directory on Your Phone

The Personal Directory feature set contains your Personal Address Book (PAB) and Fast Dial codes. This section describes how to set up and use Personal Directory on your phone. Alternately, see [Using Personal Directory on the Web, page 46](#).

If you want to...	Then...
Access Personal Directory (for PAB and Fast Dial codes)	<ol style="list-style-type: none"> 1. Press ☎, and choose Directories > Personal Directory (exact name can vary). 2. Enter your Cisco Unified CallManager user ID and PIN, then press Submit.
Search for a PAB entry	<ol style="list-style-type: none"> 1. Access Personal Directory, then choose Personal Address Book. 2. Enter search criteria and press Submit. 3. You can choose Previous or Next to move through listings. 4. Highlight the PAB listing that you want and press Select.
Dial from PAB entry	<ol style="list-style-type: none"> 1. Search for a listing. 2. Highlight the listing and press Select. 3. Press Dial. (You may need to press the more softkey to see Dial.) 4. Enter the participant's phone number. 5. Highlight the number that you want to dial and press OK. 6. Press OK again to dial the number.
Delete a PAB entry	<ol style="list-style-type: none"> 1. Search for a listing. 2. Highlight the listing and press Delete. 3. Choose OK to confirm the deletion.
Edit a PAB entry	<ol style="list-style-type: none"> 1. Search for a listing. 2. Highlight the listing and press Edit to modify a name or email address. 3. If necessary, choose Phones to modify a phone number. 4. Press Update.
Add a new PAB entry	<ol style="list-style-type: none"> 1. Access Personal Directory, then choose Personal Address Book. 2. Access the Search page by choosing Submit. (You do not need to input search information first.) 3. Press New. 4. Use your phone keypad to enter a name and email information. 5. Choose Phones and use the keypad to enter phone numbers. Be sure to include any necessary access codes such as a 9 or 1. 6. Choose Submit to add the entry to the database.

If you want to...	Then...
Assign a Fast Dial code to a PAB entry	<ol style="list-style-type: none"> 1. Search for a PAB entry. 2. Highlight the listing and press Select. 3. Press Fast Dial. 4. Highlight the number that you want to dial and press Select. 5. Highlight the Fast Dial code that you want to assign to the number and press Select.
Add a raw Fast Dial code (not using a PAB entry)	<ol style="list-style-type: none"> 1. Press , and choose Directories > Personal Directory > Personal Fast Dials. 2. Press Fast Dial. 3. Highlight a Fast Dial code that is unassigned and press Select. 4. Press Assign. 5. Enter a phone number. 6. Press Update.
Search for Fast Dial codes	<ol style="list-style-type: none"> 1. Press , and choose Directories > Personal Directory > Personal Fast Dials. 2. You can choose Previous or Next to move through listings. 3. Highlight the listing that you want and press Select.
Place a call using a Fast Dial code	<ol style="list-style-type: none"> 1. Search for a Fast Dial code. 2. Highlight the listing you want and press Select. 3. Press Dial. 4. Choose OK to complete the action.
Delete a Fast Dial code	<ol style="list-style-type: none"> 1. Search for a Fast Dial code. 2. Highlight the listing you want and press Select. 3. Press Remove.
Log out of Personal Directory	<ol style="list-style-type: none"> 1. Press , and choose Directories > Personal Directory (exact name can vary). 2. Choose Logout.

Tips



- Your system administrator can provide you the user ID and PIN that you need to log in to Personal Directory.
- Personal Directory automatically logs you out after a certain amount of time. This time limit can vary. Ask your system administrator for more information.
- Use the numbers on your keypad to enter characters on your phone screen. Use the Navigation button on your phone to move between input fields.

Accessing Voice Messages

To access voice messages, press , and select **Messages**.



Note Your company determines the voice message service that your phone system uses. For the most accurate and detailed information, refer to the documentation that came with your voice message service.

If you want to...	Then...
Set up and personalize your voice message service	Do one of the following: <ul style="list-style-type: none">• Press Msgs and follow the voice instructions.• Press , select Messages, and follow the voice instructions.
See if you have a new voice message	Look for: <ul style="list-style-type: none">• A steady red light on your handset. (This indicator can vary. See Customizing Rings and Message Indicators, page 35.)• An envelope icon  on your phone screen.
Listen to your voice messages or access the voice messages menu	Do one of the following: <ul style="list-style-type: none">• Press Msgs and follow the voice instructions.• Press , select Messages, and follow the voice instructions.
Send a call to a voice messaging system	Press iDivert . For more information, see Sending a Call to a Voice Messaging System, page 18.

Customizing Your Phone on the Web

Your Cisco Unified IP Phone is a network device that can share information with other network devices in your company, including your personal computer. You can use your computer to log in to your Cisco Unified CallManager User Options web pages, where you can control features, settings, and services for your Cisco Unified IP Phone. For example, you can set up speed-dial numbers from your User Options web pages.

Accessing Your User Options Web Pages

This section describes how to log in and select a phone device.

If you want to...	Then do this...
Log in to your User Options web pages	<ol style="list-style-type: none"> 1. Obtain a User Options URL, user ID, and default password from your system administrator. 2. Open a web browser on your computer, enter the URL, and log on. 3. If prompted to accept security settings, click Yes or Install Certificate. <p>The Cisco Unified CallManager User Options main web page displays. From this page you can select User Options to access User Settings, Directory features, a Personal Address Book, and Fast Dials.</p> <p>Or, to access phone-specific options, select a device (see below).</p>
Select a device after logging in	<ol style="list-style-type: none"> 1. After you have logged in to your User Options pages, choose User Options > Device. <p>The Device Configuration page displays.</p> <ol style="list-style-type: none"> 2. If you have multiple devices assigned to you, verify that the appropriate device (phone model or Extension Mobility profile) is selected. If necessary, choose another device from the Name drop-down menu. <p>From the Device Configuration page, you can access all of the various configuration options available for your phone (other pages might not provide access to all options).</p> <ul style="list-style-type: none"> – Choose User Options to access User Settings, Directory, Personal Address Book, and Fast Dials. – Choose toolbar buttons to access phone-specific options, such as line settings, phone service settings, and speed dials. <p>To return to the Device Configuration page from another page, choose User Options > Device.</p>

Configuring Features and Services on the Web

The topics in this section describe how to configure features and services from your User Options web pages after logging in. See [Accessing Your User Options Web Pages, page 45](#).

Using Personal Directory on the Web

The Personal Directory feature set that you can access on your computer consists of:

- A Personal Address Book (PAB)
- Fast Dials
- Cisco Unified CallManager Address Book Synchronizer



Note You can also access PAB and Fast Dials from your phone. See [Using Personal Directory on Your Phone, page 41](#).

Using Your Personal Address Book on the Web

This section describes how to use your PAB from the User Options web pages.

If you want to...	Then do this after you log in...
Add a new PAB entry	<ol style="list-style-type: none">1. Choose User Options > Personal Address Book.2. Choose New.3. Enter information for the entry.4. Click Save.
Search for a PAB entry	<ol style="list-style-type: none">1. Choose User Options > Personal Address Book.2. Specify search information and click Find.
Edit a PAB entry	<ol style="list-style-type: none">1. Search for a PAB entry.2. Click a name or nickname.3. Edit the entry as needed and click Save.
Delete a PAB entry	<ol style="list-style-type: none">1. Search for a PAB entry.2. Select one or more entries.3. Click Delete Selected.

Configuring Fast Dials on the Web

This section describes how to assign Fast Dials from your User Options web pages.

If you want to...	Then do this after you log in...
Assign a Fast Dial code to a PAB entry	<ol style="list-style-type: none"> 1. Create a PAB entry. See Using Your Personal Address Book on the Web, page 46. 2. Choose User Options > Fast Dials. 3. Click Add New. 4. Change the Fast Dial code, if desired. 5. Use the Search Options area to find the appropriate PAB entry. 6. Click a phone number in the Search Results area. 7. Click Save.
Assign a Fast Dial code to a phone number (without using a PAB entry)	<ol style="list-style-type: none"> 1. Choose User Options > Fast Dials. 2. Click Add New. 3. Change the Fast Dial code, if desired. 4. Enter a phone number. 5. Click Save.
Search for a Fast Dial entry	<ol style="list-style-type: none"> 1. Choose User Options > Fast Dials. 2. Specify search information and click Find.
Edit a Fast Dial phone number	<ol style="list-style-type: none"> 1. Choose User Options > Fast Dials. 2. Search for the Fast Dial entry that you want to edit. 3. Click on a component of the entry. 4. Change the phone number. 5. Click Save.
Delete a Fast Dial entry	<ol style="list-style-type: none"> 1. Search for a Fast Dial. 2. Select one or more entries. 3. Click Delete Selected.

Tips

- You can create up to 500 Fast Dial and PAB entries.
- You can create a new Fast Dial entry without using a PAB entry. Such Fast Dial entries are labeled “raw” in the User Options pages and do not display a configurable text label.

Using the Address Book Synchronization Tool

You can use the Cisco Unified CallManager Address Book Synchronizer to synchronize your existing Microsoft Windows Address Book (if applicable) with your PAB. Entries from your Microsoft Windows Address Book will then be accessible on your Cisco Unified IP Phone and User Options web pages. Your system administrator can give you access to Cisco Unified CallManager Address Book Synchronizer and provide detailed instructions.

Setting Up Speed Dials on the Web

Depending on configuration, your phone can support several speed-dial features:

- Speed-dial numbers
- Abbreviated Dialing
- Fast Dials



Note For help using speed dial features, see [Speed Dialing, page 24](#).

If you want to...	Then do this after you log in...
Set up speed-dial numbers	<ol style="list-style-type: none">1. Select a device.2. Click Speed Dials.3. Enter a number and label for a speed-dial number on your phone.4. Click Save. <p>Note Your phone uses the ASCII Label field if the phone does not support double-byte character sets.</p>
Set up Abbreviated dialing	<ol style="list-style-type: none">1. Select a device.2. Click Speed Dials.3. Enter a number and label for an Abbreviated Dialing code.4. Click Save.
Set up Fast Dials	See Configuring Fast Dials on the Web, page 47 . You can also set up Fast Dials on your phone. See Using Personal Directory on Your Phone, page 41 .

Setting Up Phone Services on the Web

Phone services can include special phone features, network data, and web-based information (such as stock quotes and movie listings). You must first subscribe to a phone service before accessing it on your phone.

If you want to...	Then do this after you log in and select a device...
Subscribe to a service	<ol style="list-style-type: none"> 1. Select a device. 2. Click Phone Services. 3. Click Add New. 4. Choose a service from the drop-down list and click Next. 5. Change the service label and/or enter additional service information, if available (optional). 6. Click Save.
Search for services	<ol style="list-style-type: none"> 1. Select a device. 2. Click Phone Services. 3. Click Find.
Change or end services	<ol style="list-style-type: none"> 1. Search for services. 2. Select one or more entries. 3. Click Delete Selected.
Change a service name	<ol style="list-style-type: none"> 1. Search for services. 2. Click on the service name. 3. Change the information and click Save.
Access a service on your phone	Press  and choose Services on your phone.

Controlling User Settings on the Web

User settings include your password, PIN, and language (locale) settings.

If you want to...	Then do this after you log in...
Change your password	<ol style="list-style-type: none">1. Choose User Options > User Settings.2. In the Browser Password area, enter information.3. Click Save.
Change your PIN	<ol style="list-style-type: none">1. Choose User Options > User Settings.2. In the Phone PIN area, enter information.3. Click Save.
Change the locale (language) for your User Options pages	<ol style="list-style-type: none">1. Choose User Options > User Settings.2. In the User Locale area of the User Settings page, choose an item from the Locale drop-down list.3. Click Save.
Change the language (locale) for your phone screen	<ol style="list-style-type: none">1. Go to the Device Configuration page by choosing User Options > Device.2. Choose an item from the User Locale drop-down list.3. Click Save.

Tip

Your PIN and password allow you to access different features and services. For example, use your PIN to log in to Cisco Extension Mobility or Personal Directory on your phone. Use your password to log in to your User Options web pages and Cisco WebDialer on your personal computer. For more information, ask your system administrator.

Controlling Line Settings on the Web

Line settings affect a specific phone line (directory number). Line settings can include call-forwarding, voice messaging indicators, ring patterns, and line labels.



Note

- You can also set up call forwarding directly on your phone. See [Forwarding All Calls to Another Number, page 19](#).
- To learn about phone settings that you can access directly on your phone, see [Using Phone Settings, page 35](#).

If you want to...	Then do this after you log in and select a device...
Set up call forwarding	<ol style="list-style-type: none"> 1. Select a device. 2. Click Line Settings. 3. In the Incoming Call Forwarding area, choose call forwarding settings for various conditions. 4. Click Save.
Change the message waiting indicator setting	<ol style="list-style-type: none"> 1. Select a device. 2. Click Line Settings. 3. In the Message Waiting Lamp area, choose from various settings. <p>Note Typically, the default message waiting setting prompts your phone to display a steady red light from the handset light strip to indicate a new voice message.</p> <ol style="list-style-type: none"> 4. Click Save.

If you want to...	Then do this after you log in and select a device...
Change the ring pattern	<ol style="list-style-type: none"> 1. Select a device. 2. Click Line Settings. 3. Click Find to search for your phone. 4. In the Ring Settings area, choose settings to tell your phone how to indicate an incoming call. 5. Click Save. <p>Note The “idle” ring setting pertains if you receive an incoming call when the phone is idle. The “consecutive” ring setting pertains if you receive an incoming call when the phone is active.</p>
Change or create a line text label that appears on your phone screen	<ol style="list-style-type: none"> 1. Select a device. 2. Click Line Settings. 3. In the Line Text Label area, enter a text label. 4. Click Save. <p>Note Your phone uses the ASCII Label field if the phone does not support double-byte character sets.</p>

Using Cisco WebDialer

Cisco WebDialer allows you to make calls on your Cisco Unified IP Phone to directory contacts by clicking on items in a web browser. Your system administrator must configure this feature for you.

If you want to...	Then...
Use WebDialer with your User Options directory	<ol style="list-style-type: none"> 1. Log into your User Options web pages. See Accessing Your User Options Web Pages, page 45. 2. Choose User Options > Directory and search for a coworker. 3. Click the number that you want to dial. 4. If this is your first time using WebDialer, set up preferences and click Submit. (See the last row in this table for details.) 5. If the Make Call page appears, click Dial. (See the last row in this table to learn how to suppress this page in the future, if desired.) The call is now placed on your phone. 6. To end a call, click Hangup or hang up from your phone.
Use WebDialer with another online corporate directory (not your User Options directory)	<ol style="list-style-type: none"> 1. Log in to a WebDialer-enabled corporate directory and search for coworkers. 2. Click the number that you want to dial. 3. When prompted, enter your user ID and password. 4. If this is your first time using WebDialer, set up preferences and click Submit. (See the last row in this table for details.) 5. If the Make Call page appears, click Dial. (See the last row in this table to learn how to suppress this page in the future, if desired.) The call is now placed on your phone. 6. To end a call, click Hangup or hang up from your phone.

If you want to...	Then...
Log out of WebDialer	Click the logout icon in the Make Call or Hang Up page.
Set up, view, or change WebDialer preferences	<p data-bbox="341 232 663 264">Access the Preferences page.</p> <p data-bbox="341 274 1206 334">The Preferences page appears the first time that you use WebDialer (after you click the number that you want to dial.)</p> <p data-bbox="341 344 1174 406">To return to Preferences in the future, click the preferences icon from the Make Call or Hang Up page.</p> <p data-bbox="341 415 944 448">The Preferences page contains the following options:</p> <ul data-bbox="354 457 1206 917" style="list-style-type: none"> <li data-bbox="354 457 1139 519">• Preferred language—Determines the language used for WebDialer settings and prompts. <li data-bbox="354 529 1206 711">• Use permanent device—Identifies the Cisco Unified IP Phone and directory number (line) that you will use to place WebDialer calls. If you have one phone with a single line, the appropriate phone and line are automatically selected. Otherwise, choose a phone and/or line. Phones are specified by host name. (To display the host name on your phone, press  and choose Settings > Network Configuration > Host Name.) <li data-bbox="354 721 1206 815">• Use Extension Mobility—If selected, prompts WebDialer to use the Cisco Unified IP Phone that is associated with your Extension Mobility profile (if available). <li data-bbox="354 824 1206 917">• Do not display call confirmation—If selected, prompts WebDialer to suppress the Make Call page. This page appears by default after you click a phone number in a WebDialer-enabled online directory.

Understanding Additional Configuration Options

Your system administrator can configure your phone to use specific button and softkey templates along with special services and features, if appropriate. This table provides an overview of some configuration options that you might want to discuss with your phone system administrator based on your calling needs or work environment.



Note You can locate Phone Guides and other documents listed in this table on the web: http://www.cisco.com/univercd/cc/td/doc/product/voice/c_ipphon/index.htm

If you...	Then...	For more information...
Need to handle more calls on your phone line	Ask your system administrator to configure your line to support more calls.	Talk to your system administrator or phone support team.
Work with (or work as) an administrative assistant (SCCP phones only)	Consider using a shared line.	See Using a Shared Line, page 26 .
Want to use one extension for several phones	Request a shared line. This allows you to use one extension for your desk phone and lab phone, for example.	See Using a Shared Line, page 26 .

If you...	Then...	For more information...
Share phones or office space with coworkers	Consider using: <ul style="list-style-type: none"> • Call Park to store and retrieve calls without using the transfer feature. • Call Pickup to answer calls ringing on another phone. • A shared line to view or join co-workers' calls. • Cisco Extension Mobility to apply your phone number and user profile to a shared Cisco Unified IP Phone. 	Ask your system administrator about these features and see: <ul style="list-style-type: none"> • Advanced Call Handling, page 24. • Using a Shared Line, page 26. • Using Cisco Extension Mobility, page 31.
Want to temporarily apply your phone number and settings to a shared Cisco Unified IP Phone	Ask your system administrator about the Cisco Extension Mobility service.	See Using Cisco Extension Mobility, page 31.

Troubleshooting Your Phone

This section provides troubleshooting information for your Cisco Unified IP Phone.





General Troubleshooting

This section provides information to help you troubleshoot general problems with your phone. For more information, see your system administrator.

Symptom	Explanation
You cannot hear a dial tone or complete a call	One or more of the following factors might apply: <ul style="list-style-type: none"> You must log into the Extension Mobility service. You must enter a client matter code (CMC) or forced authorization code (FAC) after dialing a number. (SCCP phones only.) Your phone has time-of-day restrictions that prevent you from using some features during certain hours of the day.
The softkey that you want to use does not appear	One or more of the following factors might apply: <ul style="list-style-type: none"> You must press more to reveal additional softkeys. You must change the line state (for example, go off-hook or have a connected call). Your phone is not configured to support the feature associated with that softkey.
Join fails (SCCP phones only)	Join requires multiple selected calls. Be sure that you have selected at least one call in addition to the active call, which is selected automatically.
Barge fails and results in a fast busy tone	You cannot barge an encrypted call if the phone you are using is not configured for encryption. When your barge attempt fails for this reason, your phone plays a fast busy tone.
You are disconnected from a call that you joined using Barge	You will be disconnected from a call that you have joined using Barge if the call is put on hold, transferred, or turned into a conference call.
Cisco CallBack fails	The other party might have call forwarding enabled.

Viewing Phone Administration Data

Your system administrator might ask you to access administration data on your phone for troubleshooting purposes.

If you are asked to...	Then...
Access network configuration data	Press  and choose Settings > Network Configuration and select the network configuration item that you want to view.
Access status data	Press  and choose Settings > Status and select the status item that you want to view.
Access phone model information	Press  and choose Settings > Model Information .
Access phone call and voice quality information (SCCP phones only)	Press  and choose Settings > Status > Call Statistics .

Using the Quality Reporting Tool

Your system administrator may temporarily configure your phone with the Quality Reporting Tool (QRT) to troubleshoot performance problems. You can press **QRT** to submit information to your system administrator. Depending on configuration, use the QRT to:

- Immediately report an audio problem on a current call
- Select a general problem from a list of categories and choose reason codes

Cisco One-Year Limited Hardware Warranty Terms

There are special terms applicable to your hardware warranty and various services that you can use during the warranty period. Your formal Warranty Statement, including the warranties and license agreements applicable to Cisco software, is available on Cisco.com. Follow these steps to access and download the *Cisco Information Packet* and your warranty and license agreements from Cisco.com.

1. Launch your browser, and go to this URL:
http://www.cisco.com/univercd/cc/td/doc/es_inpk/cetrans.htm
The Warranties and License Agreements page appears.
2. To read the *Cisco Information Packet*, follow these steps:
 - a. Click the **Information Packet Number** field, and make sure that the part number 78-5235-03A0 is highlighted.
 - b. Select the language in which you would like to read the document.
 - c. Click **Go**.
 - d. The Cisco Limited Warranty and Software License page from the Information Packet appears.
 - e. Read the document online, or click the **PDF** icon to download and print the document in Adobe Portable Document Format (PDF).

**Note**

You must have Adobe Acrobat Reader to view and print PDF files. You can download the reader from the Adobe website: <http://www.adobe.com>

3. To read translated and localized warranty information about your product, follow these steps:
 - a. Enter this part number in the Warranty Document Number field:
78-10747-01C0
 - b. Select the language in which you would like to view the document.
 - c. Click **Go**.
The Cisco warranty page appears.
 - d. Read the document online, or click the **PDF** icon to download and print the document in Adobe Portable Document Format (PDF).

You can also contact the Cisco service and support website for assistance:

http://www.cisco.com/public/Support_root.shtml.

Duration of Hardware Warranty

One (1) Year

Replacement, Repair, or Refund Policy for Hardware

Cisco or its service center will use commercially reasonable efforts to ship a replacement part within ten (10) working days after receipt of a Return Materials Authorization (RMA) request. Actual delivery times can vary, depending on the customer location.

Cisco reserves the right to refund the purchase price as its exclusive warranty remedy.

To Receive a Return Materials Authorization (RMA) Number

Contact the company from whom you purchased the product. If you purchased the product directly from Cisco, contact your Cisco Sales and Service Representative.

Complete the information below, and keep it for reference.

Company product purchased from	
Company telephone number	
Product model number	
Product serial number	
Maintenance contract number	



Index

A

Abbreviated Dialing **14, 24**
answering calls **15**
Applications Menu button **10**
Applications menus, using **11**
ASCII label field support **48, 52**
authenticated calls **28**
Auto Dial **13**
AutoAnswer **15**

B

background image, customizing **36**
barge
 and privacy **27**
 and shared lines **26**
barge, using **26**
buttons, identifying **9**

C

call forwarding **19**
 configuring from web page **51**
 configuring on phone **19**
call logs
 dialing from **13**
 erasing **37**

 viewing and dialing from **37**
call park **15, 28**
call pickup **15, 25**
call waiting **15**
CallBack **14**
caller ID **10**
call-handling
 advanced **24**
 basic **13**
calls
 answering **15**
 compared to lines **11**
 conference features for **20**
 ending **16**
 forwarding **19**
 handling multiple **15**
 holding and resuming **16**
 icons for **12**
 maximum per line **11**
 monitoring **32**
 multiple parties on **20**
 multiple, switching between **16**
 parking **28**
 placing **13, 14**
 prevent barging of **27**
 prioritizing **30**
 redirecting while ringing **25**

- reporting problems with **58**
- secure **28**
- storing and retrieving **28**
- transferring **17**
- using Join with **21**
- viewing **10, 17**
- cBarge
 - using **26**
 - See also* barge
- Cisco Extension Mobility feature, using **15**
- Cisco Unified CallManager Address Book Synchronizer **48**
- Cisco Unified IP Phone
 - connecting **5**
 - documentation for **2**
 - feature configuration for **12**
 - illustration **9**
 - protocol **12**
 - registering **7**
 - SCCP **12**
 - securing handset rest **7**
 - SIP **12**
 - troubleshooting **57**
 - web-based services for **49**
- Cisco WebDialer **52**
- Client Matter Code
 - See* CMC
- CMC **57**
- conference calls
 - Meet-Me **21, 23**
 - standard **21**
- corporate directory
 - dialing from **14**
 - dialing from web page **14**

- using on phone **40**

D

- Details softkey, viewing multiparty calls with **38**
- Device Configuration page **45**
- dialing options
 - additional **14**
 - basic **13**
- dialing, options for **13, 14**
- directory
 - corporate **40**
 - personal **41**
 - using from web page **52**
 - using on phone **37**
- directory, dialing from **14**
- DND **20**
- Do Not Disturb (DND) **20**
- documentation, accessing **2**

E

- encrypted calls **28**
- ending a call, options **16**
- Extension Mobility
 - EM **31**
- external devices, using **4**

F

- FAC **57**
- Fast Dials
 - configuring from web page **42**

- using on phone **41**
- features, availability of **12**
- Forced Authorization Code
 - See* FAC
- forwarding calls, options for **19**

G

- group call pickup **25**
- Group Listen **32**

H

- handset
 - light strip **10**
 - securing in cradle **7**
 - using **32, 33**
- hands-free listening **32**
- hanging up, options for **16**
- headset
 - connecting **7**
 - performance **8**
- help, using **11**
- hold
 - and switching calls **16**
 - and transferring **17**
 - using **16**
- hold button illustration **10**

I

- icons, for call states **12**
- installing, Cisco Unified IP Phone **5**

J

- Join, using **21**

K

- keypad description **10**

L

- language (locale) settings **50**
- lines
 - compared to calls **11**
 - description **11**
 - description of **11**
 - number of calls supported on **11, 55**
 - ring patterns for **52**
 - shared **26**
 - text label for **52**
 - voice message indicator setting for **51**

M

- Malicious Call Identification
 - See* MCID
- MCID
- Meet-Me conferences **21, 23**
- menus, using **11**
- messages
 - indicator for **35**
 - listening to **44**
- missed calls, records of **37**
- MLPP, using **30**
- monitoring a call **32**

- multiparty calls
 - identifying in call logs **38**
 - viewing details of **38**
- multiple calls, handling **15, 17**

N

- navigation button illustration **10**

O

- off-hook dialing **13**
- on-hook dialing **13**

P

- PAB
 - using from web page **46**
 - using on phone **41**
- parking a call **15**
- password, changing **50**
- Personal Address Book
 - See PAB*
- Personal Address Book, dialing from **14**
- Personal Directory
 - using from web page **46**
 - using on phone **41**
- phone lines, description of **11**
- phone services **46**
 - See also User Options web pages*
- phone services, configuring **46**
- PIN
 - changing **50**

- placed calls, records of **37**
- placing a call **13**
- placing calls, options for **13, 14**
- pre-dial **13**
- prioritizing calls **30**
- privacy
 - and shared lines **26**
 - using **27**

Q

- QRT **58**
- Quality Reporting Tool **58**

R

- received calls, records of **37**
- redial **13**
- remote-in-use icon for shared lines **26**
- resuming held calls **16**
- ring patterns, changing **52**
- ring tones, changing **35**
- ringer
 - customizing **35**
 - indicator for **10**
 - volume for **35**

S

- safety warnings **2**
- SCCP (Skinny Call Control Protocol) **12**
- secure calls **28**
- security, for calls **28**

- services
 - subscribing to **49**
- settings, customizing **35**
- shared lines
 - and remote-in-use icon **26**
 - description of **26**
 - with barge **26**
 - with privacy **27**
- signaling protocol **12**
- SIP (Session Initiation Protocol) **12**
- softkey buttons, description of **10**
- sound quality **8**
- speaker
 - answering calls with **15**
 - using **16**
- speaker, using **32**
- speed dial
 - configuring **24**
 - description of **24**
 - labels **48**
 - using **14**
- subscriptions, for phone services **49**
- suspicious calls, tracing **29**
- switching calls **16**

T

- TAPS **7**
- Tool for Auto-Registered Phones Support **7**
- transferring, options for **17**
- troubleshooting
 - general **57**
 - QRT **58**

U

- User Options web pages
 - accessing **45**
 - configuring features and services with **46**
 - subscribing to phone services with **49**
- using a headset **7**

V

- voice message indicator
 - changing setting for **51**
 - description of **44**
- voice messages, accessing **44**
- volume
 - for handset, headset, or speaker **32, 33**
 - for phone ringer **35**
- volume button illustration **10**

W

- warnings, safety **2**
- web-based services
 - configuring **46**
 - See also* User Options web pages
- WebDialer **52**



Corporate Headquarters
Cisco Systems, Inc.
170 West Tasman Drive
San Jose, CA 95134-1706
USA
www.cisco.com
Tel: 408 526-4000
800 553-NETS (6387)
Fax: 408 526-4100

European Headquarters
Cisco Systems International BV
Haarlerbergpark
Haarlerbergweg 13-19
1101 CH Amsterdam
The Netherlands
www-europe.cisco.com
Tel: 31 0 20 357 1000
Fax: 31 0 20 357 1100

Americas Headquarters
Cisco Systems, Inc.
170 West Tasman Drive
San Jose, CA 95134-1706
USA
www.cisco.com
Tel: 408 526-7660
Fax: 408 527-0883

Asia Pacific Headquarters
Cisco Systems, Inc.
168 Robinson Road
#28-01 Capital Tower
Singapore 068912
www.cisco.com
Tel: +65 6317 7777
Fax: +65 6317 7799

Cisco Systems has more than 200 offices in the following countries. Addresses, phone numbers, and fax numbers are listed on the **Cisco Website at www.cisco.com/go/offices**

Argentina • Australia • Austria • Belgium • Brazil • Bulgaria • Canada • Chile • China PRC • Colombia • Costa Rica • Croatia • Cyprus • Czech Republic • Denmark • Dubai, UAE
Finland • France • Germany • Greece • Hong Kong SAR • Hungary • India • Indonesia • Ireland • Israel • Italy • Japan • Korea • Luxembourg • Malaysia • Mexico
The Netherlands • New Zealand • Norway • Peru • Philippines • Poland • Portugal • Puerto Rico • Romania • Russia • Saudi Arabia • Scotland • Singapore
Slovakia • Slovenia • South Africa • Spain • Sweden • Switzerland • Taiwan • Thailand • Turkey • Ukraine • United Kingdom • United States • Venezuela • Vietnam • Zimbabwe

CCVP, the Cisco Logo, and the Cisco Square Bridge logo are trademarks of Cisco Systems, Inc.; Changing the Way We Work, Live, Play, and Learn is a service mark of Cisco Systems, Inc.; and Access Registrar, Aironet, BPX, Catalyst, CCDA, CCDP, CCIE, CCIIP, CCNA, CCNP, CCSP, Cisco, the Cisco Certified Internetwork Expert logo, Cisco IOS, Cisco Press, Cisco Systems, Cisco Systems Capital, the Cisco Systems logo, Cisco Unity, Enterprise/Solver, EtherChannel, EtherFast, EtherSwitch, Fast Step, Follow Me Browsing, FormShare, GigaDrive, GigaStack, HomeLink, Internet Quotient, IOS, IP/TV, iQ Expertise, the iQ logo, iQ Net Readiness Scorecard, iQuick Study, LightStream, Linksys, MeetingPlace, MGX, Networking Academy, Network Registrar, *Packet*, PIX, ProConnect, RateMUX, ScriptShare, SlideCast, SMARTnet, StackWise, The Fastest Way to Increase Your Internet Quotient, and TransPath are registered trademarks of Cisco Systems, Inc. and/or its affiliates in the United States and certain other countries.

All other trademarks mentioned in this document or Website are the property of their respective owners. The use of the word partner does not imply a partnership relationship between Cisco and any other company. (0609R)

© 2006 Cisco Systems, Inc. All rights reserved.



The Java logo is a trademark or registered trademark of Sun Microsystems, Inc. in the U.S. or other countries.